



US00D594831S

(12) **United States Design Patent**
Misawa

(10) **Patent No.:** **US D594,831 S**
(45) **Date of Patent:** **** Jun. 23, 2009**

(54) **MOBILE PHONE**

(75) Inventor: **Atsushi Misawa**, Asaka (JP)

(73) Assignee: **Fujifilm Corporation**, Tokyo (JP)

(**) Term: **14 Years**

(21) Appl. No.: **29/296,176**

(22) Filed: **Oct. 16, 2007**

(30) **Foreign Application Priority Data**

Apr. 17, 2007 (JP) 2007-010212

(51) **LOC (9) Cl.** **14-03**

(52) **U.S. Cl.** **D14/138 AB**

(58) **Field of Classification Search** D14/138 AB,
D14/138 AA, 496, 341-347, 247, 455-456,
D14/218; 455/575.3, 575.1

See application file for complete search history.

(56) **References Cited**

U.S. PATENT DOCUMENTS

D431,539 S * 10/2000 Kuo D14/138 AB

(Continued)

OTHER PUBLICATIONS

Samsung A300 telephone, announced 2001, [online], [site visited Nov. 4, 2008]. Available from Internet, <URL: <http://www.gsmarena.com>>.*

(Continued)

Primary Examiner—Jeffrey D Asch

(74) *Attorney, Agent, or Firm*—Young & Thompson

(57) **CLAIM**

The ornamental design for a mobile phone, as shown and described.

DESCRIPTION

FIG. 1 is a top, front and right side perspective view, in an unfolded position, of a mobile-phone showing my new design;

FIG. 2 is a front elevational view thereof;

FIG. 3 is a rear elevational view thereof;

FIG. 4 is a top plan view thereof;

FIG. 5 is a bottom plan view thereof;

FIG. 6 is a left side elevational view thereof;

FIG. 7 is a right side elevational view thereof;

FIG. 8 is a top, front and right side perspective view thereof in a folded position;

FIG. 9 is a front elevational view thereof;

FIG. 10 is a rear elevational view thereof;

FIG. 11 is a top plan view thereof;

FIG. 12 is a bottom plan view thereof;

FIG. 13 is a left side elevational view thereof; and,

FIG. 14 is a right side elevational view thereof.

The broken lines throughout the views, which are immediately adjacent to the shaded areas and define unshaded regions, represent the bounds of the claimed design, while all other broken lines are directed to environment and are for illustrative purposes only; the broken lines form no part of the claimed design.

1 Claim, 7 Drawing Sheets

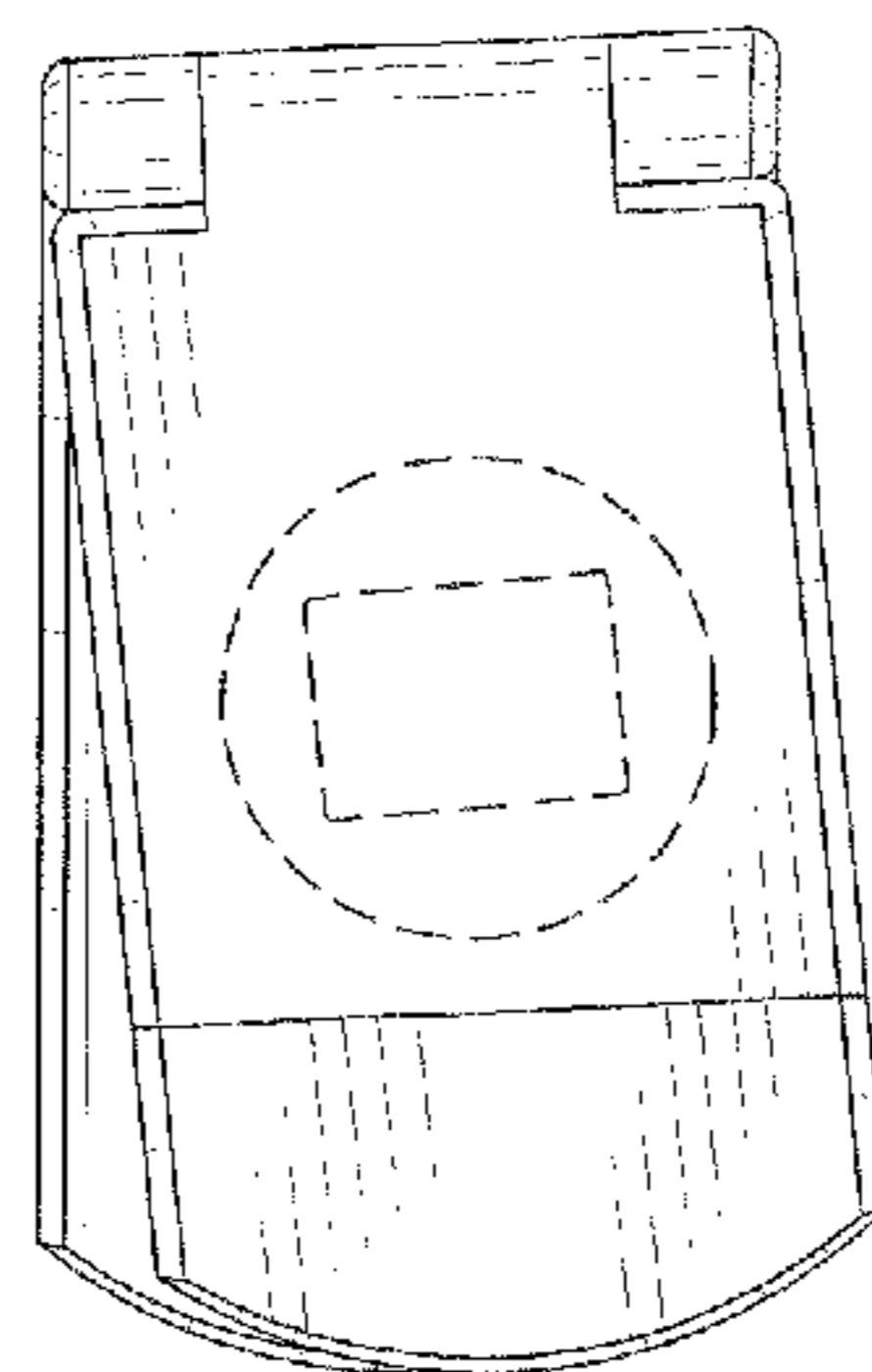
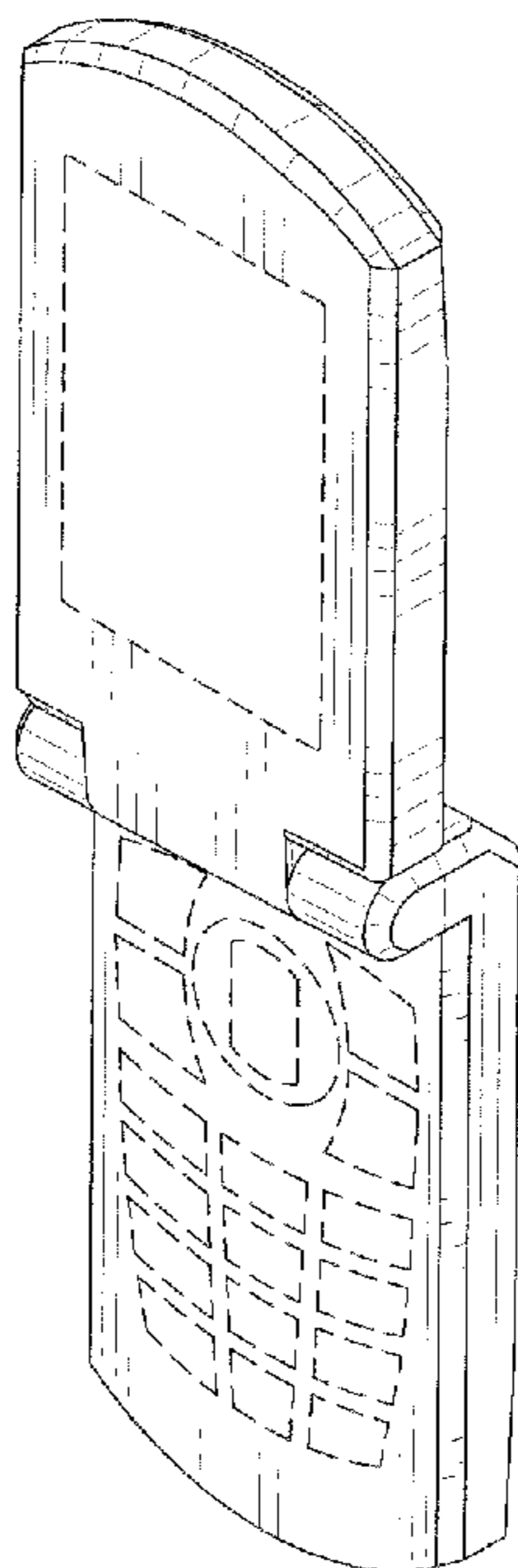

U.S. PATENT DOCUMENTS

D446,201 S * 8/2001 Kim D14/138 AB
 D485,249 S * 1/2004 Liao et al. D14/138 AB
 D493,440 S * 7/2004 Chou et al. D14/138 AB
 D496,016 S * 9/2004 Hoo D14/138 AB
 D508,036 S * 8/2005 Wada D14/138 AB
 D519,971 S * 5/2006 Morita et al. D14/138 AB
 D520,980 S * 5/2006 Taniyama et al. D14/138 AB
 7,181,253 B2 * 2/2007 Kim 455/575.1
 D545,796 S * 7/2007 Kim et al. D14/138 AB
 D558,170 S * 12/2007 Wang et al. D14/138 AB
 D559,814 S * 1/2008 Kim et al. D14/138 AB
 D564,485 S * 3/2008 Kim et al. D14/138 AB
 D565,004 S * 3/2008 Oh et al. D14/138 AB
 D565,006 S * 3/2008 Griffin et al. D14/138 AB
 7,346,377 B2 * 3/2008 Sakai et al. 455/575.3
 D566,087 S * 4/2008 Choi D14/138 AB
 D573,120 S * 7/2008 Griffin et al. D14/138
 D574,801 S * 8/2008 Arnold D14/138
 D575,256 S * 8/2008 Kim et al. D14/138
 D575,755 S * 8/2008 Kim et al. D14/138
 D576,594 S * 9/2008 Lee et al. D14/138 AB
 D576,984 S * 9/2008 Park et al. D14/138 AB
 D578,096 S * 10/2008 Park et al. D14/138 AB
 2006/0094482 A1 * 5/2006 Takagi 455/575.3
 2006/0154702 A1 * 7/2006 Kang et al. 455/575.3
 2007/0054710 A1 * 3/2007 Pan 455/575.3
 2007/0142100 A1 * 6/2007 Lee 455/575.3
 2007/0149262 A1 * 6/2007 Navntoft 455/575.3
 2008/0004082 A1 * 1/2008 Bloebaum 455/566

OTHER PUBLICATIONS

Sony Ericsson Z300 telephone, announced Nov. 2005, [online], [site visited Nov. 4, 2008]. Available from Internet ,<URL: <http://www.gsmarena.com>>.*
 BenQ S680C telephone, announced 3rd quarter 2004, [online], [site visited Nov. 4, 2008]. Available from Internet ,<URL: <http://www.gsmarena.com>>.*
 Philips 598 telephone, announced Mar. 2007, [online], [site visited Nov. 4, 2008]. Available from Internet ,<URL: <http://www.gsmarena.com>>.*
 NEC 804N telephone, announced Apr. 2006, [online], [site visited Nov. 4, 2008]. Available from Internet ,<URL: <http://www.gsmarena.com>>.*
 VK Mobile VK500 telephone, announced 2nd quarter 2004, [online], [site visited Nov. 4, 2008]. Available from Internet ,<URL: <http://www.gsmarena.com>>.*
 Haier A7 telephone, announced 2006, [online], [site visited Nov. 4, 2008]. Available from Internet ,<URL: <http://www.gsmarena.com>>.*
 NEC N620 telephone, announced 3rd quarter 2004, [online], [site visited Nov. 4, 2008]. Available from Internet ,<URL: <http://www.gsmarena.com>>.*
 Maxon MX-7940 telephone, announced 2003, [online], [site visited Nov. 4, 2008]. Available from Internet ,<URL: <http://www.gsmarena.com>>.*

* cited by examiner

Fig. 1

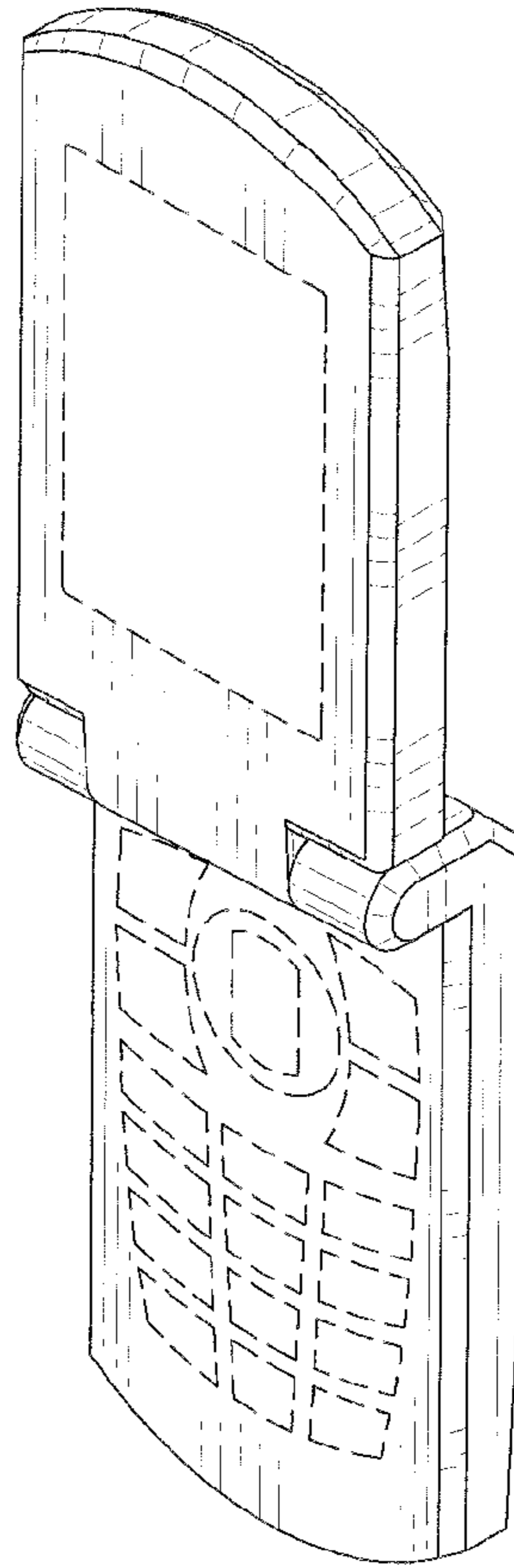

Fig. 2

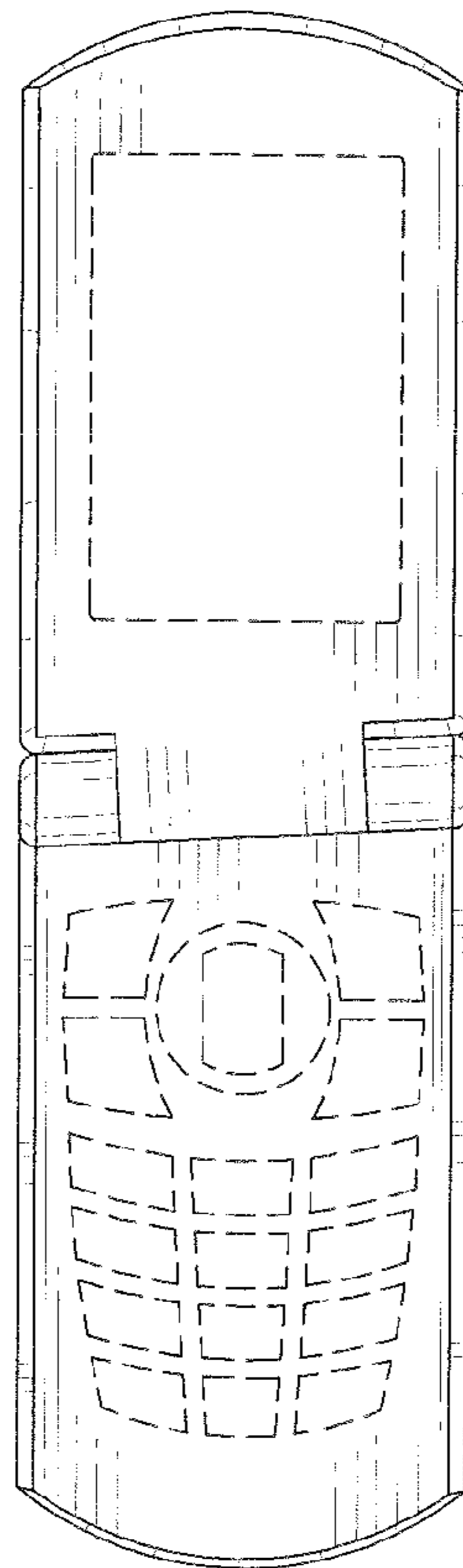

FIG.3

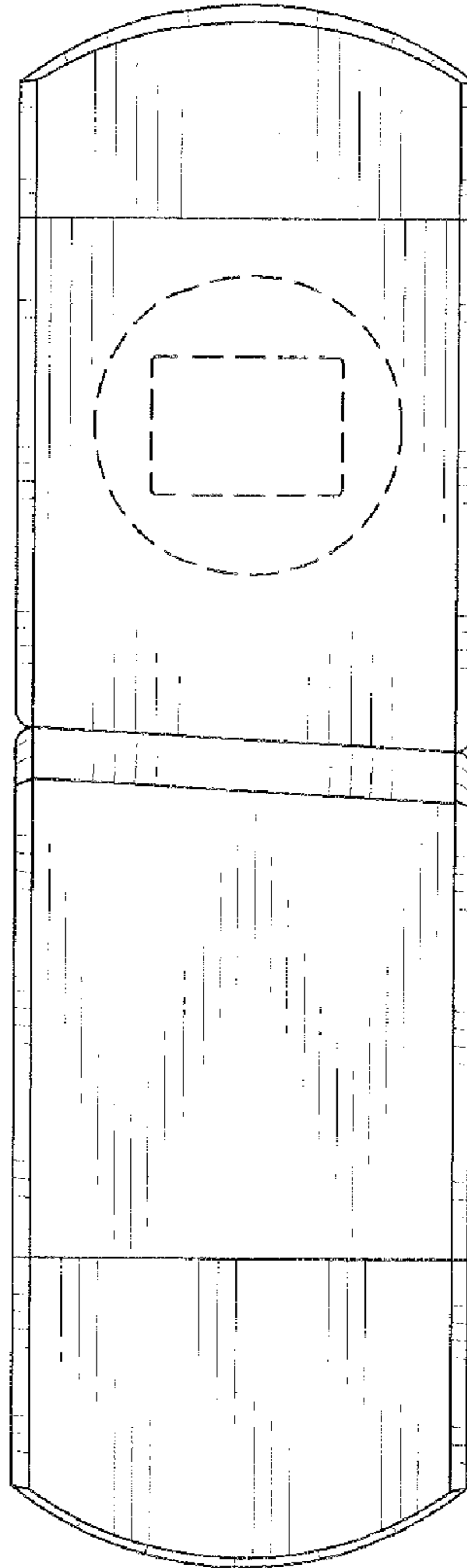

FIG.4

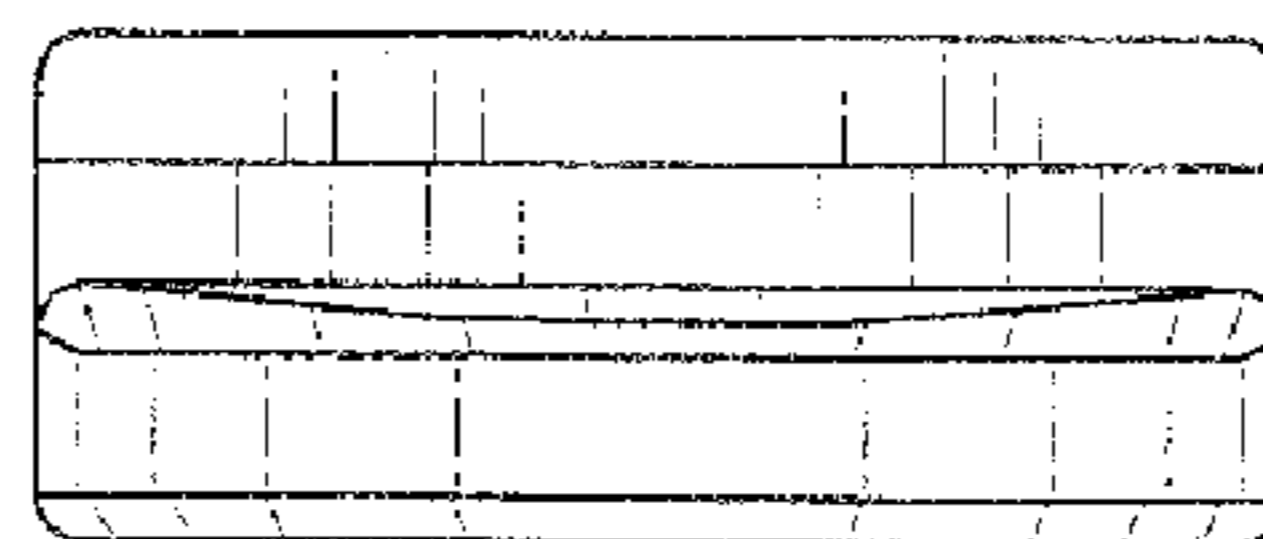

FIG.5

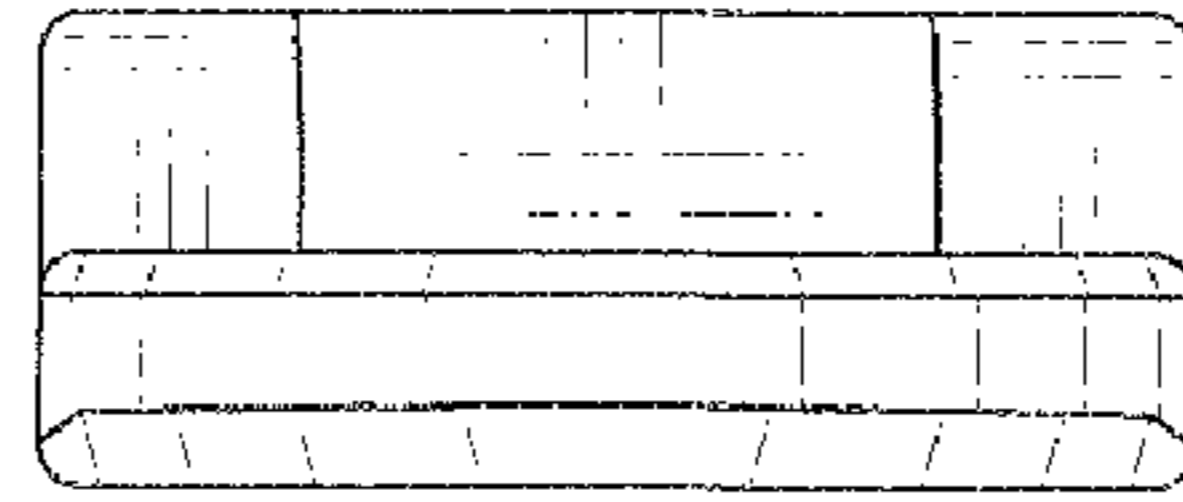

FIG.6

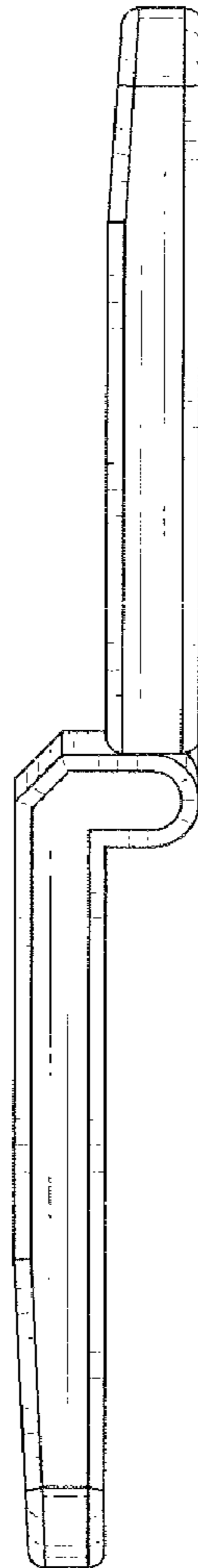

FIG.7

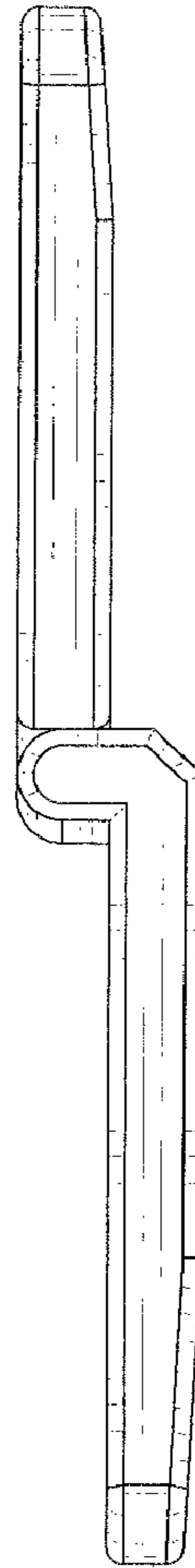

FIG.8

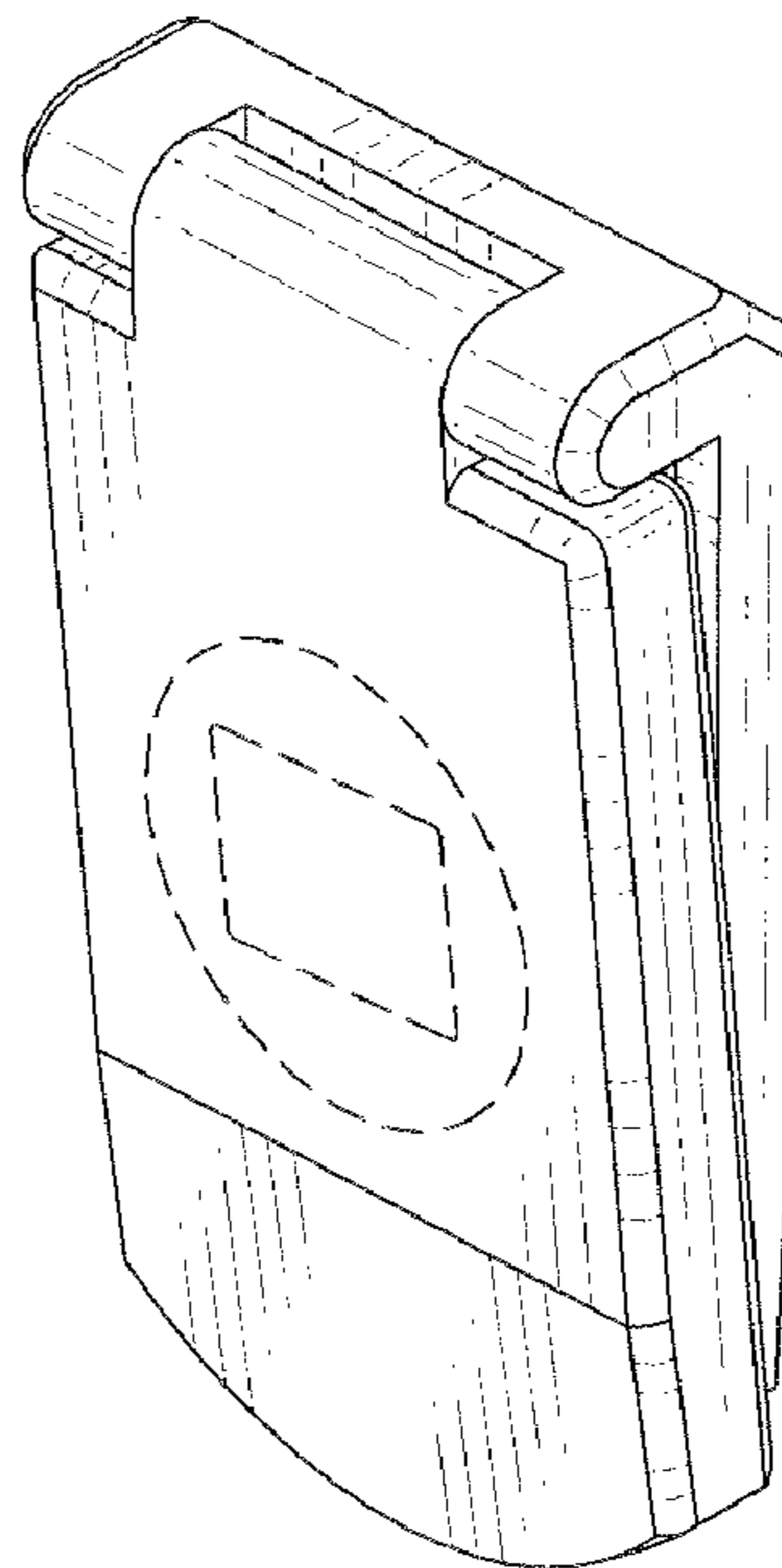

FIG.9

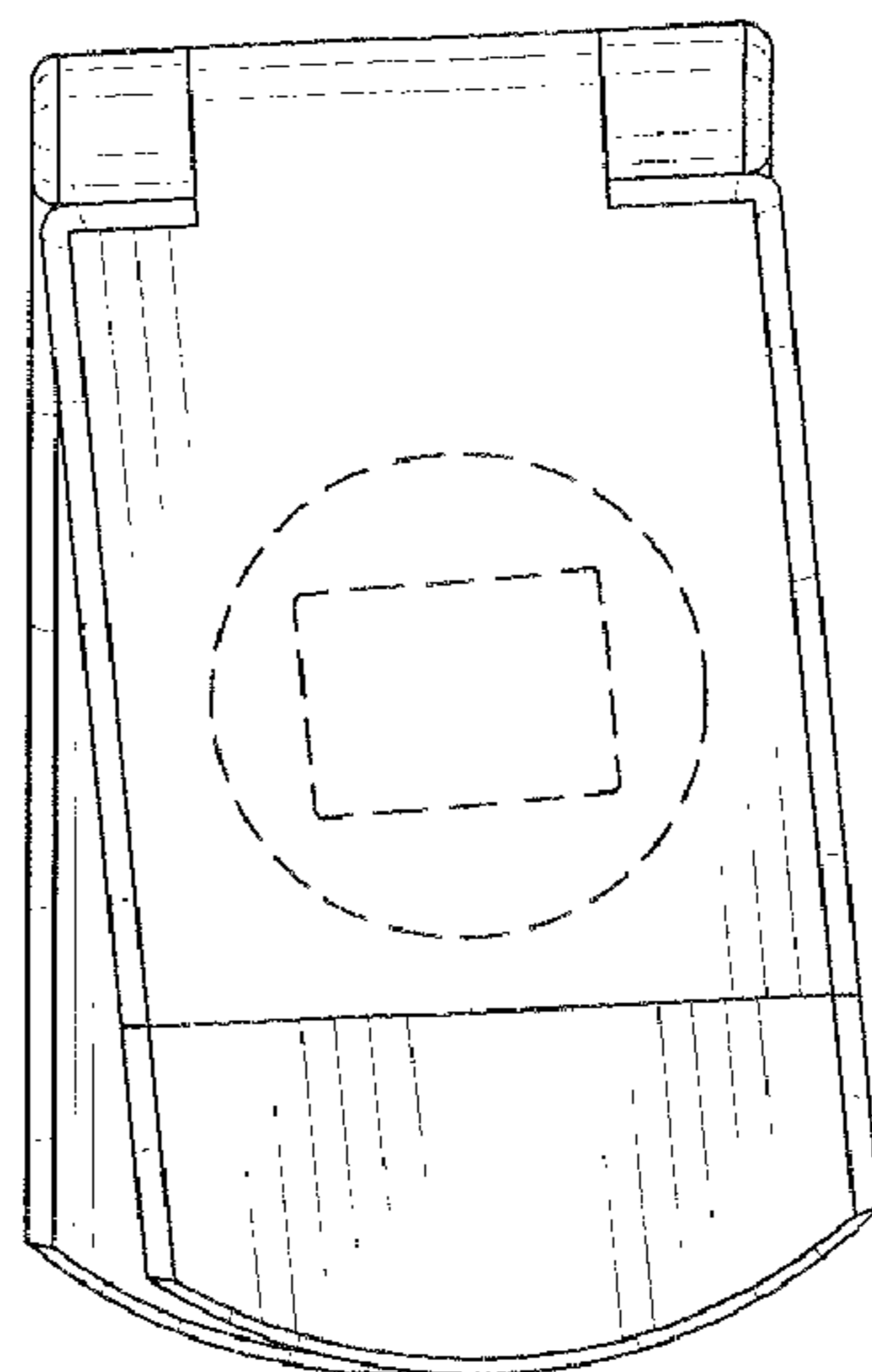

FIG.10

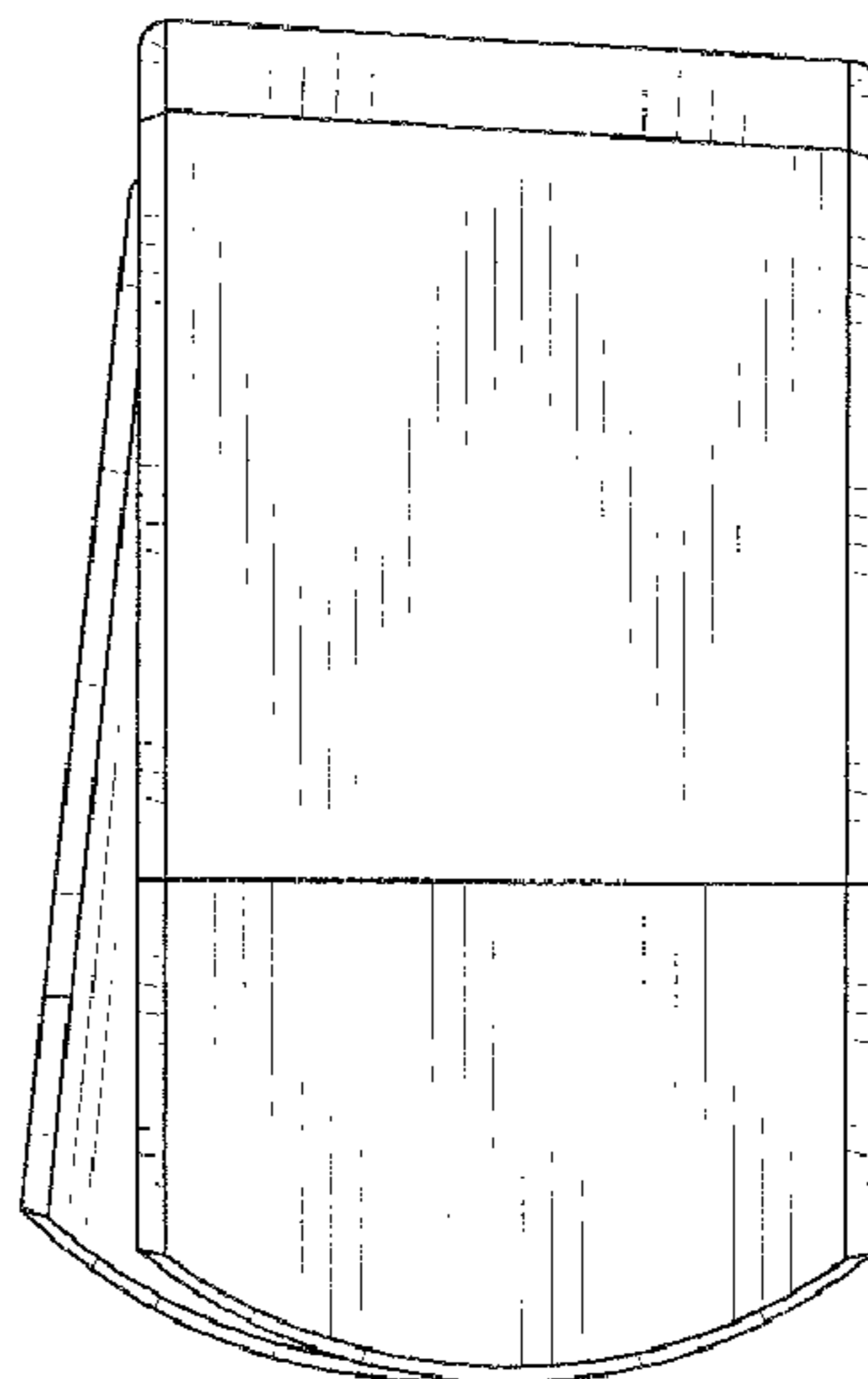

FIG. 11

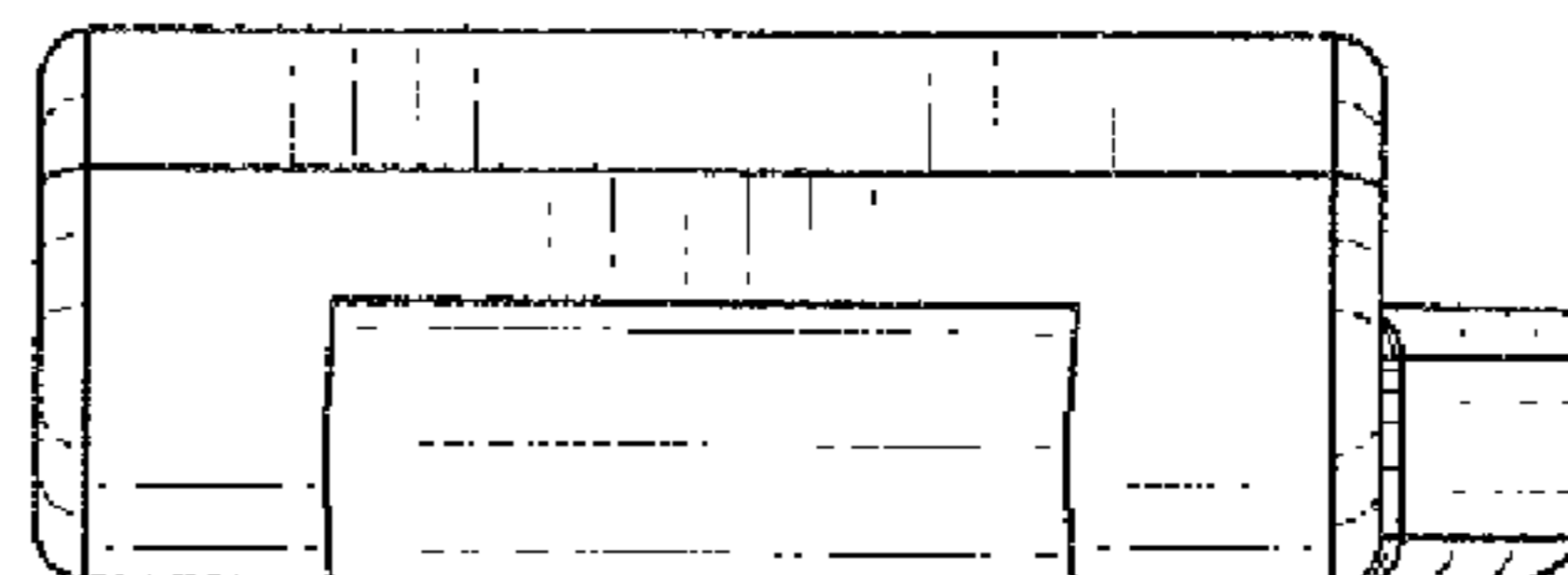

FIG. 12

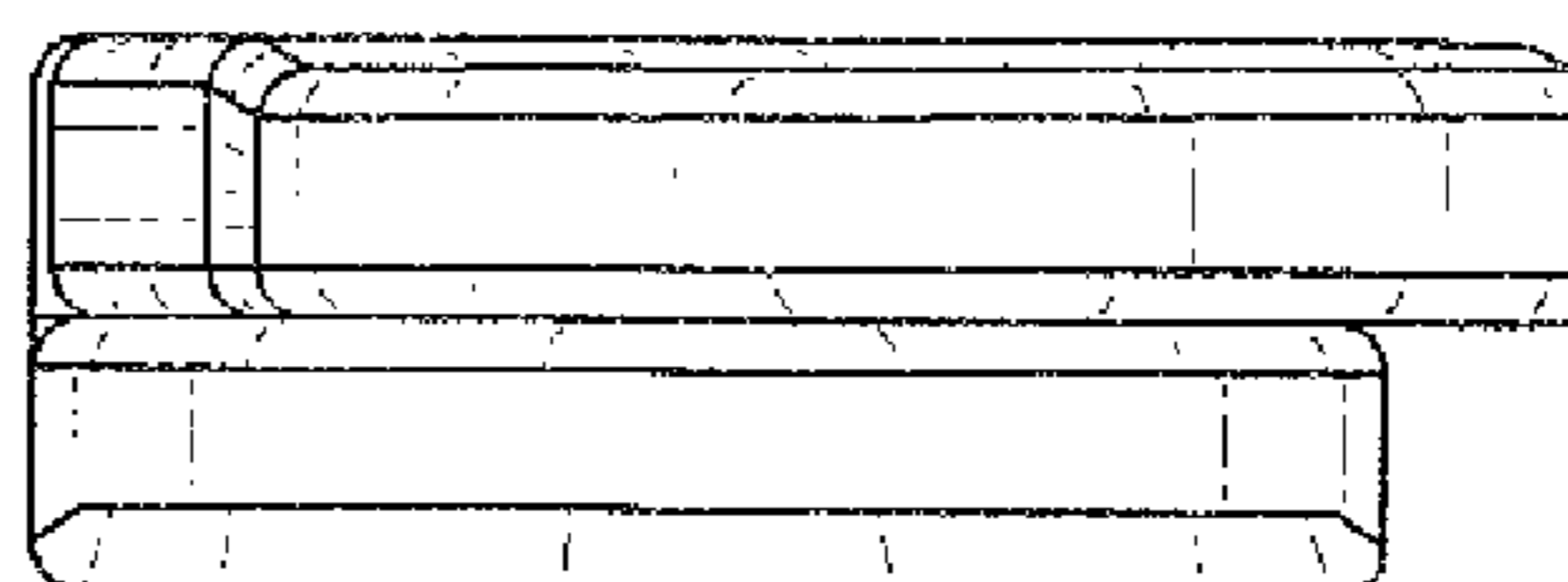

FIG. 13

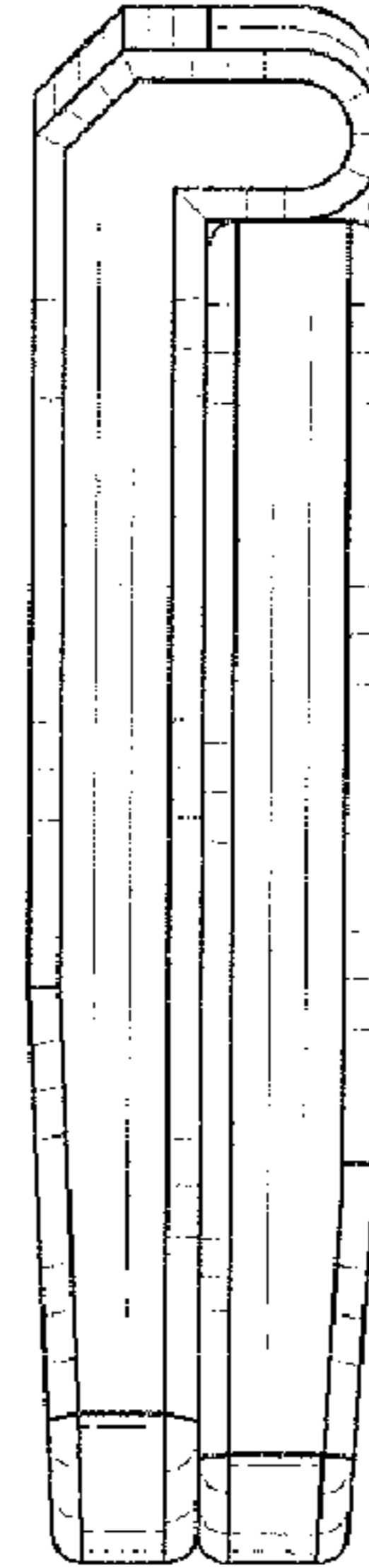

FIG. 14

