



US00D594482S

(12) **United States Design Patent**  
**Roekens et al.**

(10) **Patent No.:** **US D594,482 S**  
(45) **Date of Patent:** **\*\* Jun. 16, 2009**

(54) **COOLER**

(75) Inventors: **Jurgen Roekens**, Steenokkerzeel (BE);  
**Hugo Smid**, Antwerp (BE); **Stefano Menghini**, Folgino (IT)

(73) Assignee: **The Coca-Cola Company**, Atlanta, GA (US)

(\*\*) Term: **14 Years**

(21) Appl. No.: **29/306,774**

(22) Filed: **Apr. 16, 2008**

(51) **LOC (9) Cl.** ..... **15-07**

(52) **U.S. Cl.** ..... **D15/81; D15/79**

(58) **Field of Classification Search** ..... D15/79,  
D15/81, 85, 86, 88; D6/396, 397; 62/246,  
62/440, 467, 531; 312/114, 116, 401-408  
See application file for complete search history.

(56) **References Cited**

**U.S. PATENT DOCUMENTS**

- D350,245 S \* 9/1994 Branz et al. .... D6/472
- D363,398 S \* 10/1995 Branz et al. .... D6/472
- D398,791 S \* 9/1998 Brancheau et al. .... D6/470
- 5,803,560 A \* 9/1998 Trulaske et al. .... 312/223.5
- D404,935 S \* 2/1999 Shappell ..... D6/472
- D513,014 S \* 12/2005 Seki ..... D15/81

- D515,595 S \* 2/2006 Jorgensen ..... D15/81
- D515,596 S \* 2/2006 Jorgensen ..... D15/81
- D547,776 S \* 7/2007 Debontridder ..... D15/81
- D554,670 S \* 11/2007 Jorgensen ..... D15/81

\* cited by examiner

*Primary Examiner*—Stella M Reid

*Assistant Examiner*—Shanda C Hill

(74) *Attorney, Agent, or Firm*—Ivor J. Longo

(57) **CLAIM**

We claim the ornamental design for a cooler, as shown and described.

**DESCRIPTION**

FIG. 1 is a top, front, left side perspective view of a cooler showing our new design;

FIG. 2 is a front elevational view thereof;

FIG. 3 is a left side elevational view thereof;

FIG. 4 is a right side elevational view thereof;

FIG. 5 is a back elevational view thereof;

FIG. 6 is a top plan view thereof; and,

FIG. 7 is a bottom plan view thereof.

The broken lines in the drawings are for illustrative purposes only and form no part of the claimed design.

**1 Claim, 6 Drawing Sheets**

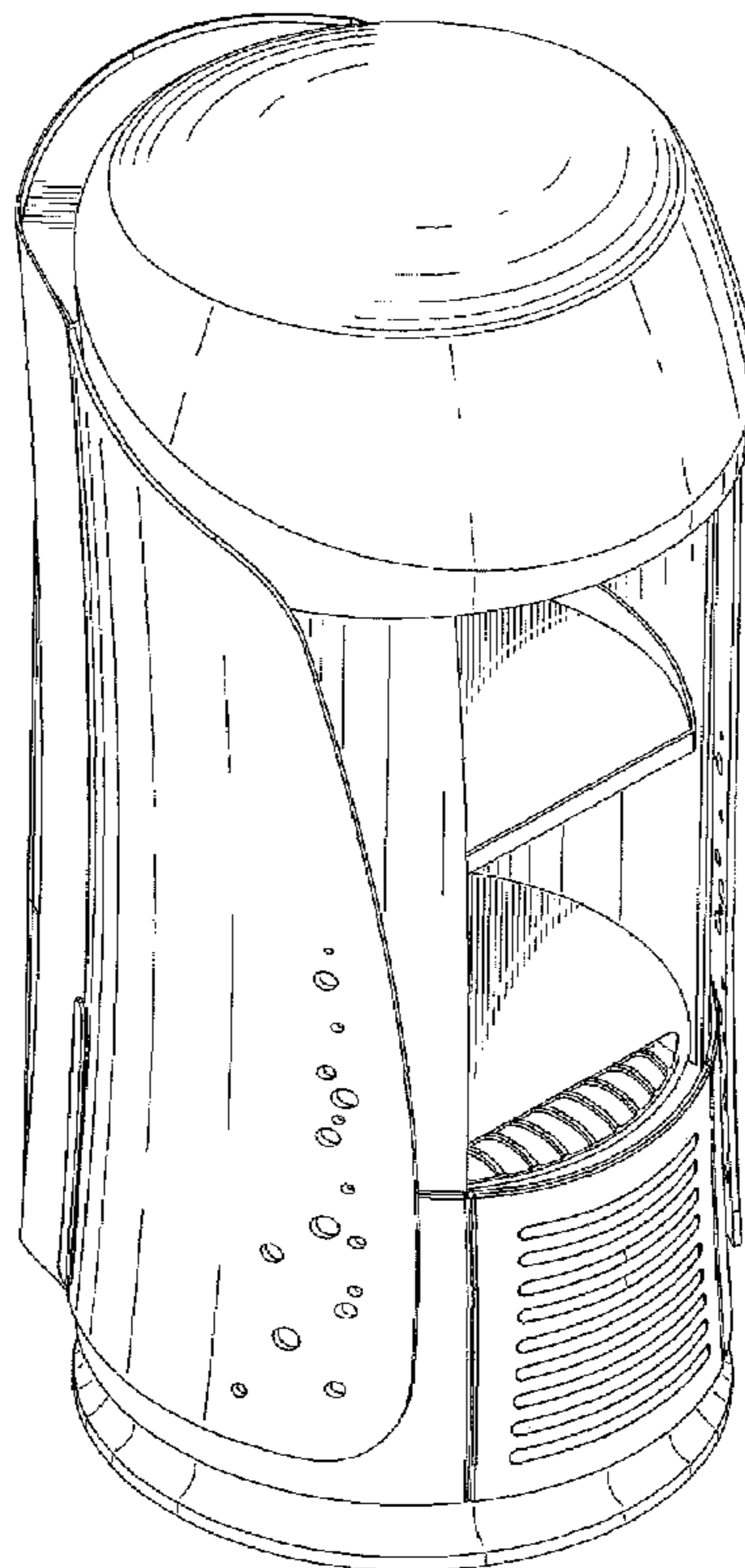

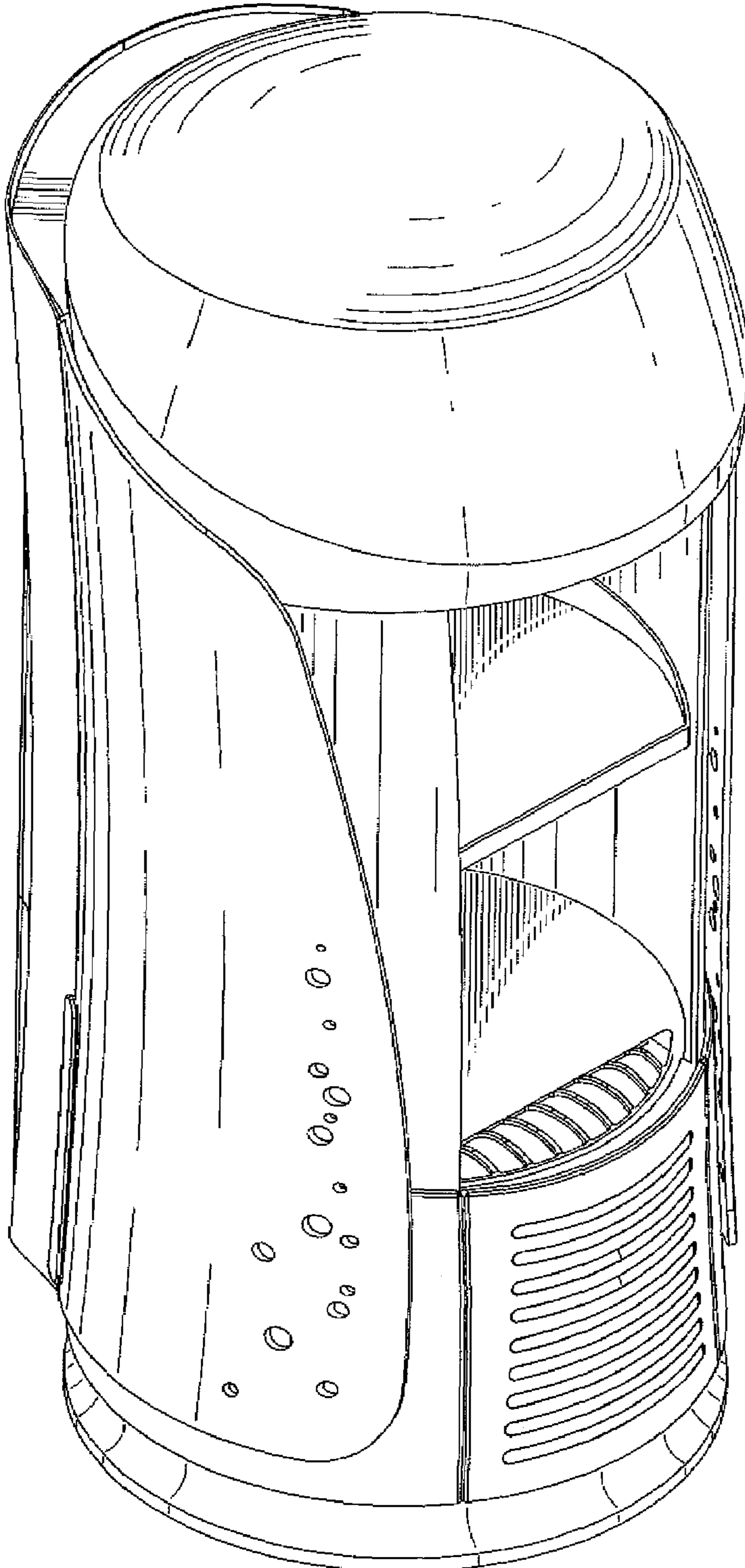

Fig. 1

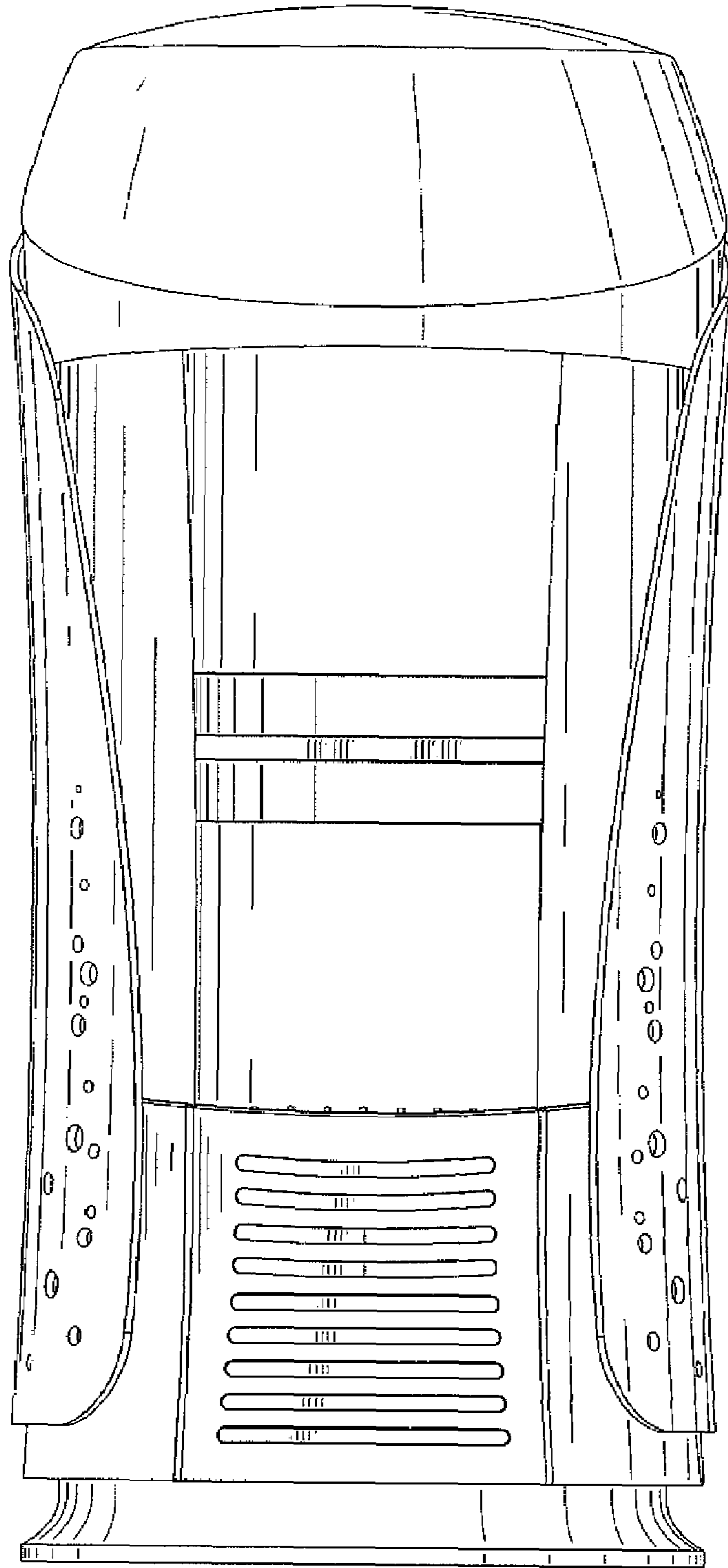
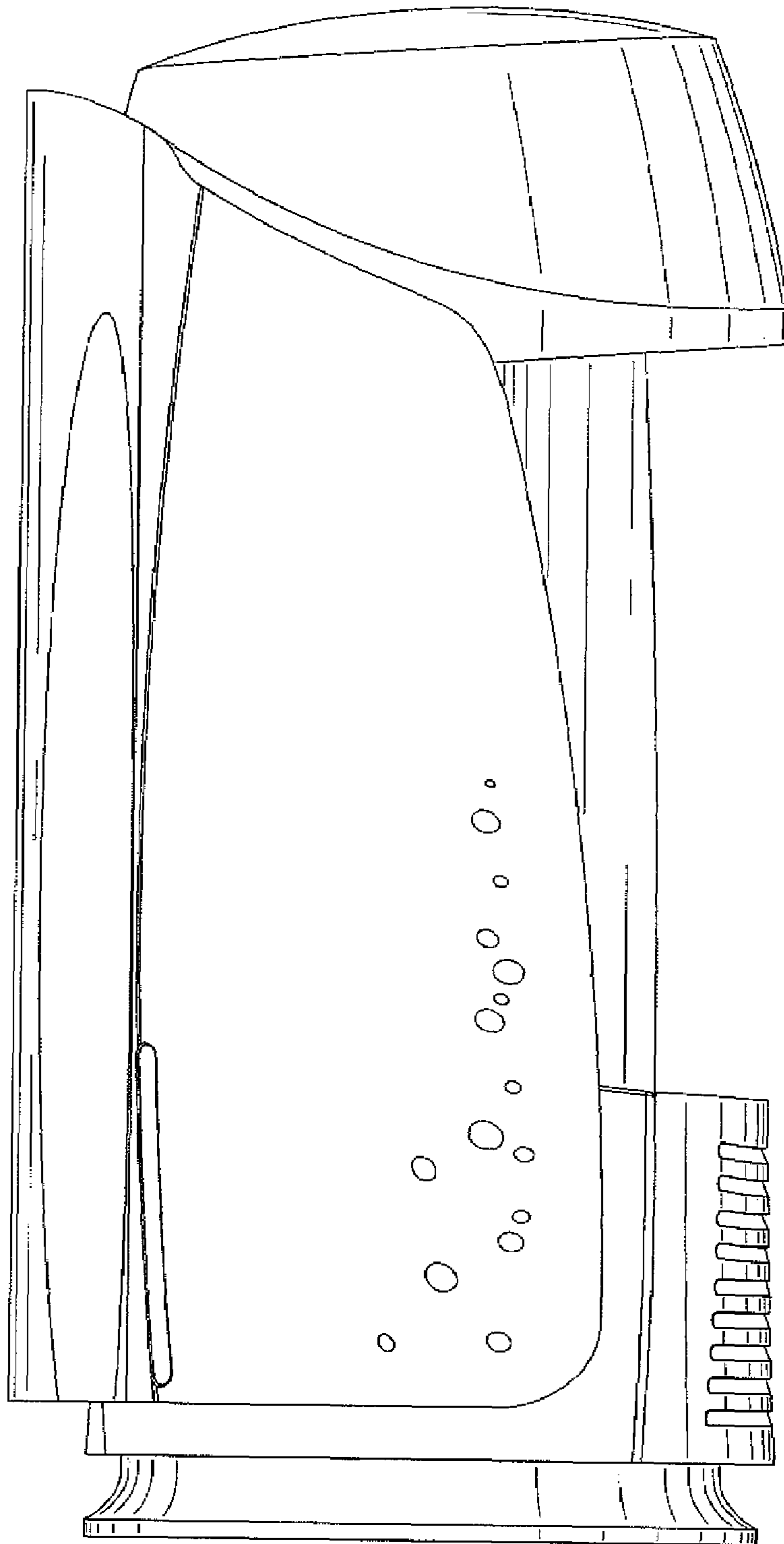

Fig. 2



**Fig. 3**

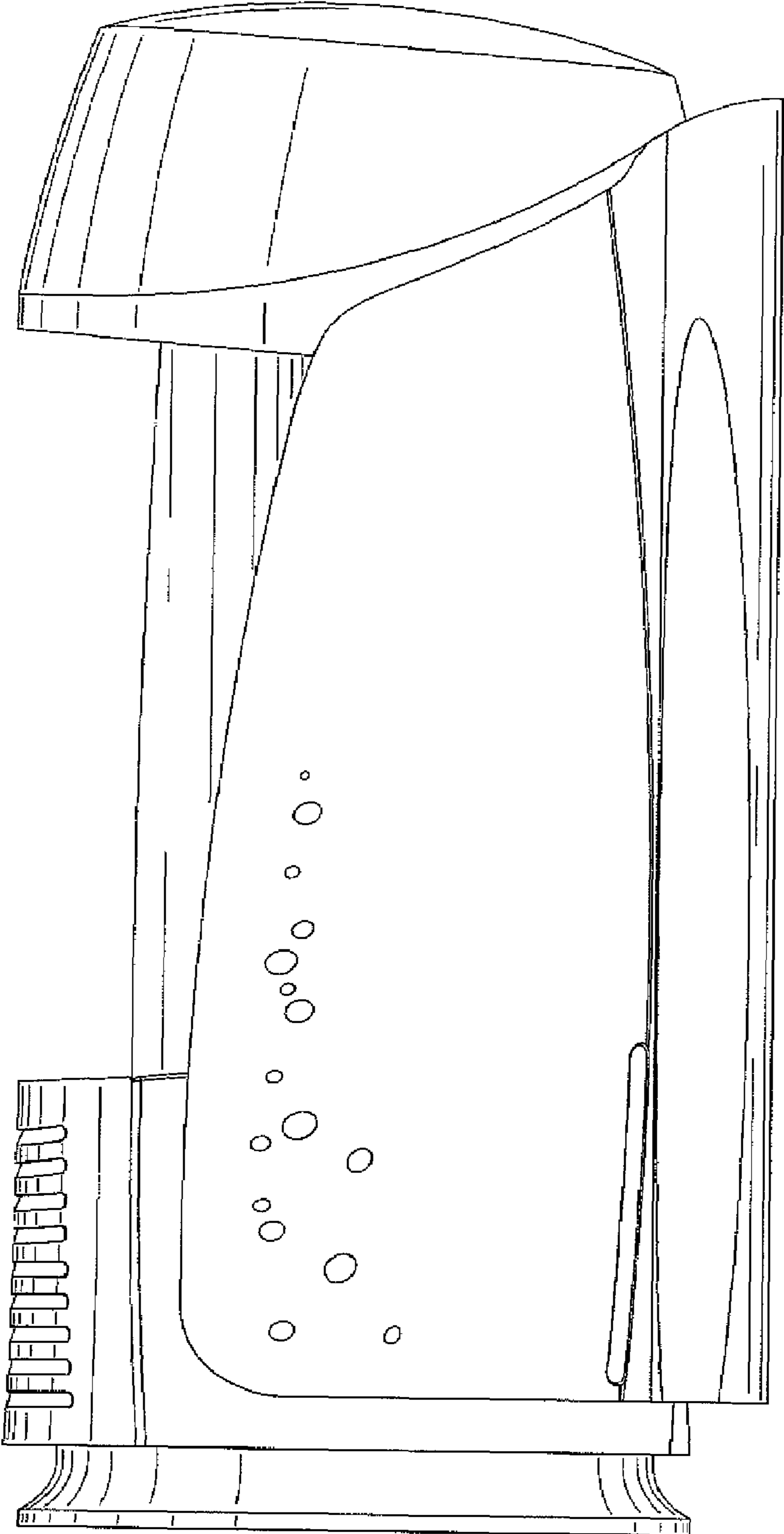
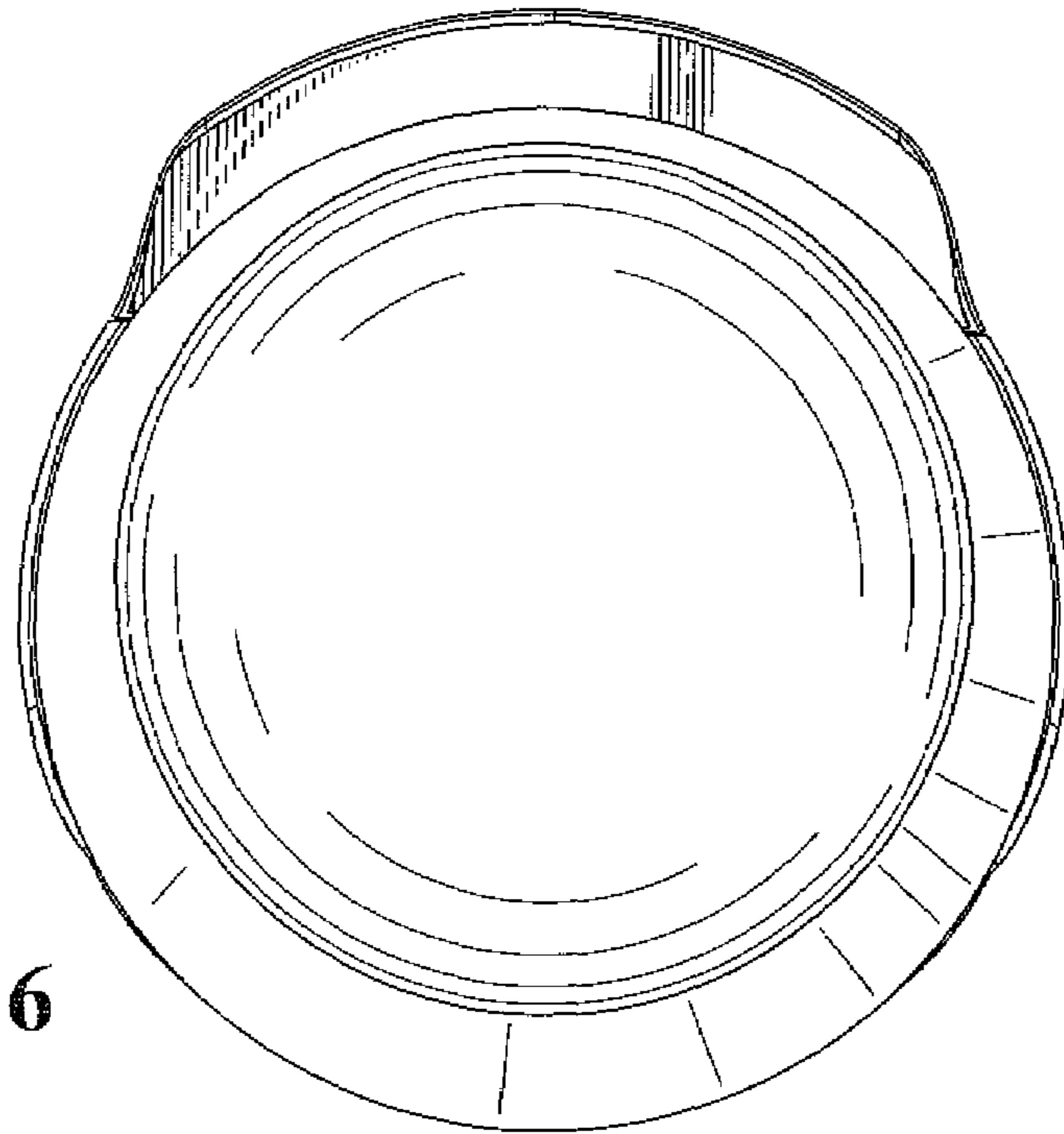

Fig. 4

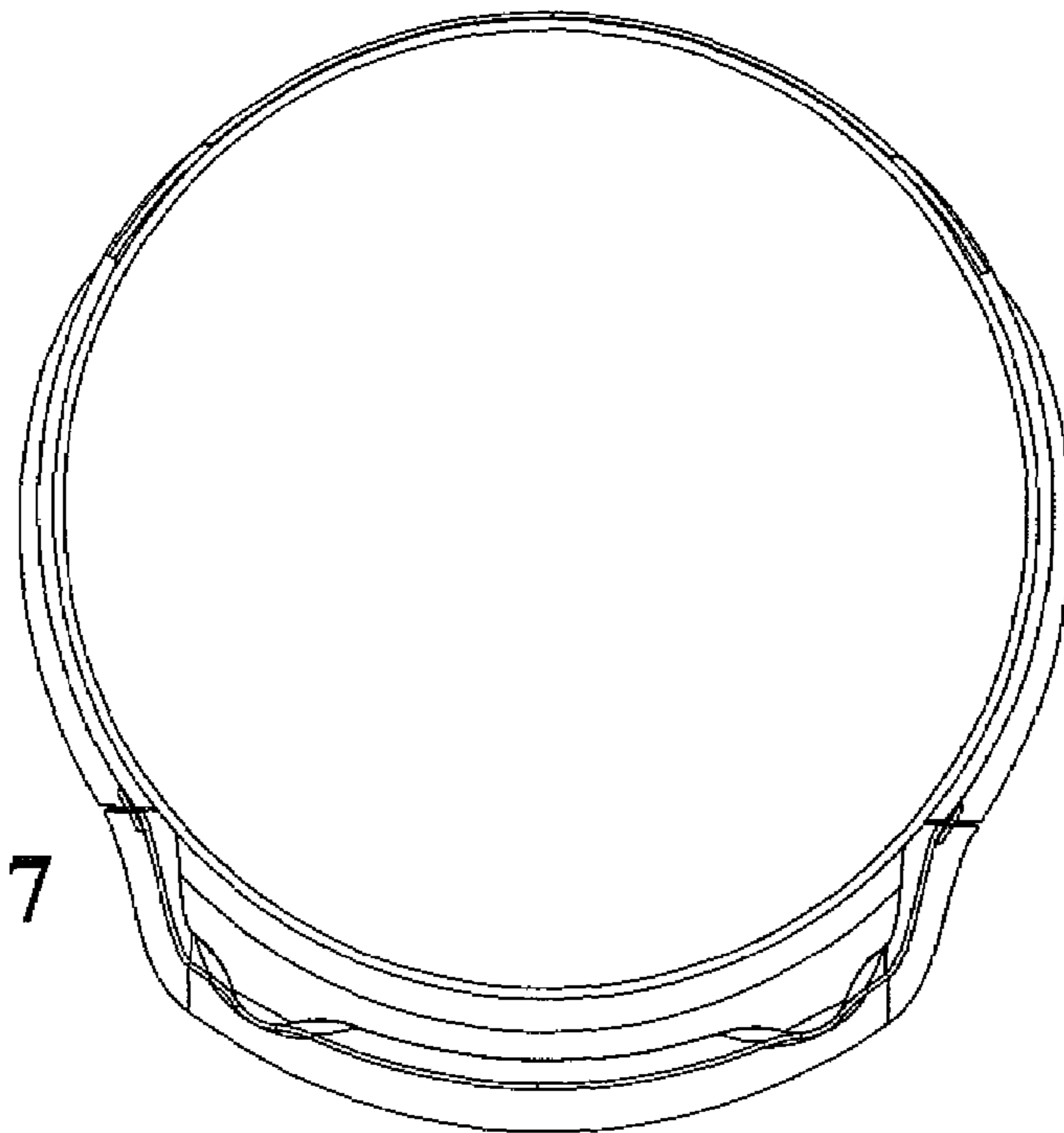

Fig. 5





**Fig. 6**



**Fig. 7**