



US00D594433S

(12) **United States Design Patent**
Seo et al.

(10) **Patent No.:** **US D594,433 S**
(45) **Date of Patent:** **** *Jun. 16, 2009**

(54) **MOBILE PHONE**

(75) Inventors: **Hyun Seung Seo**, Seoul (KR); **Jung Soo Yang**, Seoul (KR)

(73) Assignee: **LG Electronics Inc.**, Seoul (KR)

(*) Notice: This patent is subject to a terminal disclaimer.

(**) Term: **14 Years**

(21) Appl. No.: **29/300,154**

(22) Filed: **Feb. 27, 2008**

(30) **Foreign Application Priority Data**

Aug. 28, 2007 (KR) 30-2007-0036708

(51) **LOC (9) Cl.** **14-03**

(52) **U.S. Cl.** **D14/138 AD; D14/138 G**

(58) **Field of Classification Search** D14/137,
D14/138, 147, 191, 218, 247-248, 341-347,
D14/496; D10/65, 78, 104; D13/168; D18/7;
455/556.1, 566, 575.1, 575.3; 345/169
See application file for complete search history.

(56) **References Cited**

U.S. PATENT DOCUMENTS

D337,569	S	*	7/1993	Kando	D14/341
D464,961	S	*	10/2002	Sogabe	D14/346
D526,302	S	*	8/2006	Kim	D14/138
D527,366	S	*	8/2006	Lee	D14/138
D531,609	S	*	11/2006	Kim et al.	D14/138
D535,275	S	*	1/2007	Kim et al.	D14/138
D548,713	S	*	8/2007	Lee et al.	D14/138
D551,647	S	*	9/2007	Kim et al.	D14/138
D552,580	S	*	10/2007	Mun	D14/138
D552,583	S	*	10/2007	Choi et al.	D14/138
D554,099	S	*	10/2007	Kim et al.	D14/138
D558,720	S	*	1/2008	Lee et al.	D14/138
D560,193	S	*	1/2008	Sung et al.	D14/138
D560,200	S	*	1/2008	Mun et al.	D14/138
D563,933	S	*	3/2008	Lee et al.	D14/138

D567,792	S	*	4/2008	Park et al.	D14/138
D567,797	S	*	4/2008	Suk et al.	D14/138
D568,286	S	*	5/2008	Suk et al.	D14/138
D569,365	S	*	5/2008	Shin et al.	D14/138
D571,234	S	*	6/2008	Reeson et al.	D10/65
D574,348	S	*	8/2008	Mun	D14/138
2005/0233708	A1	*	10/2005	Im et al.	455/90.3
2006/0093133	A1	*	5/2006	Park et al.	379/433.12
2008/0019083	A1	*	1/2008	Lim et al.	361/679
2008/0096616	A1	*	4/2008	Choi	455/575.1
2008/0176607	A1	*	7/2008	Jin et al.	455/566

OTHER PUBLICATIONS

LG KE970, announced Jan. 2007, [online], [retrieved on Feb. 20, 2007]. Retrieved from Internet ,<URL: <http://www.gsmarena.com>>.*

(Continued)

Primary Examiner—Jeffrey D Asch

Assistant Examiner—Bridget L Eland

(74) *Attorney, Agent, or Firm*—Morgan, Lewis & Bockius LLP

(57) **CLAIM**

The ornamental design for a mobile phone, as shown and described.

DESCRIPTION

FIG. 1 is a perspective view of a mobile phone showing our new design;

FIG. 2 is a front view thereof;

FIG. 3 is a rear view thereof;

FIG. 4 is a left side view thereof;

FIG. 5 is a right side view thereof;

FIG. 6 is a top plan view thereof;

FIG. 7 is a bottom plan view thereof; and,

FIG. 8 is a front view thereof in a condition that the upper body thereof is slided upward and the inner key pad is exposed.

1 Claim, 7 Drawing Sheets

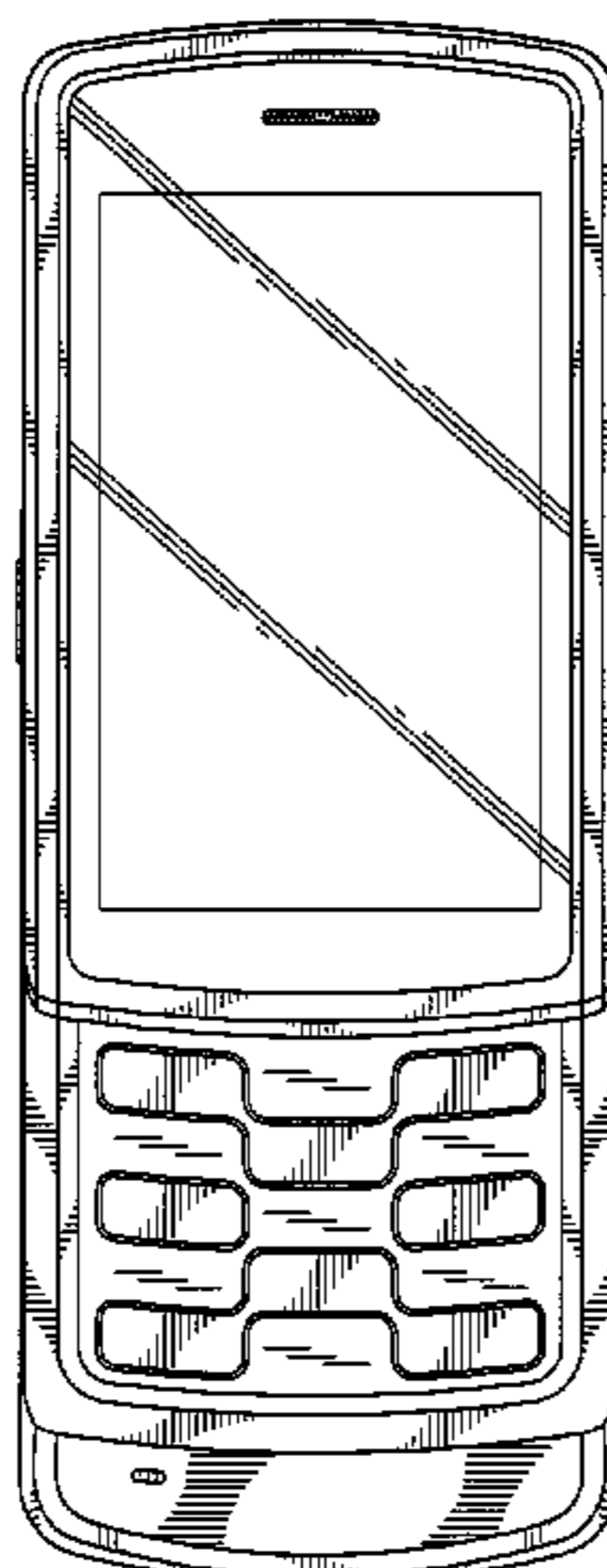
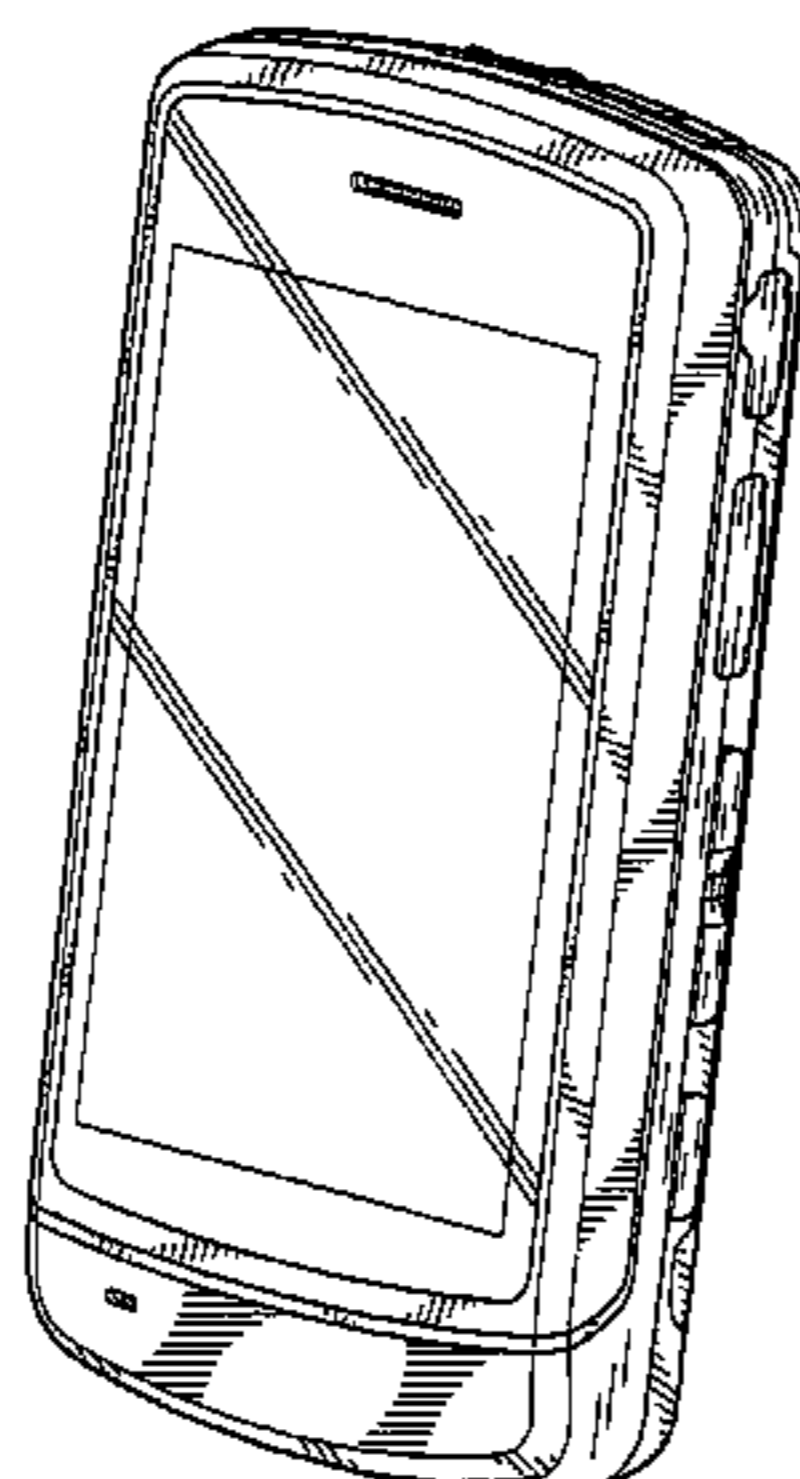

OTHER PUBLICATIONS

Samsung P930, announced Dec. 2006, [online], [retrieved on Feb. 8, 2007]. Retrieved from Internet ,<URL: <http://www.gsmarena.com>>.*

Motorola VE75, announced Jul. 2008, [online], [retrieved on Aug. 15, 2008]. Retrieved from Internet ,<URL: <http://www.gsmarena.com>>.*

LG KF750 Secret, announced Apr. 2008, [online], [retrieved on May 14, 2008]. Retrieved from Internet ,<URL: <http://www.gsmarena.com>>.*

* cited by examiner

FIG. 1

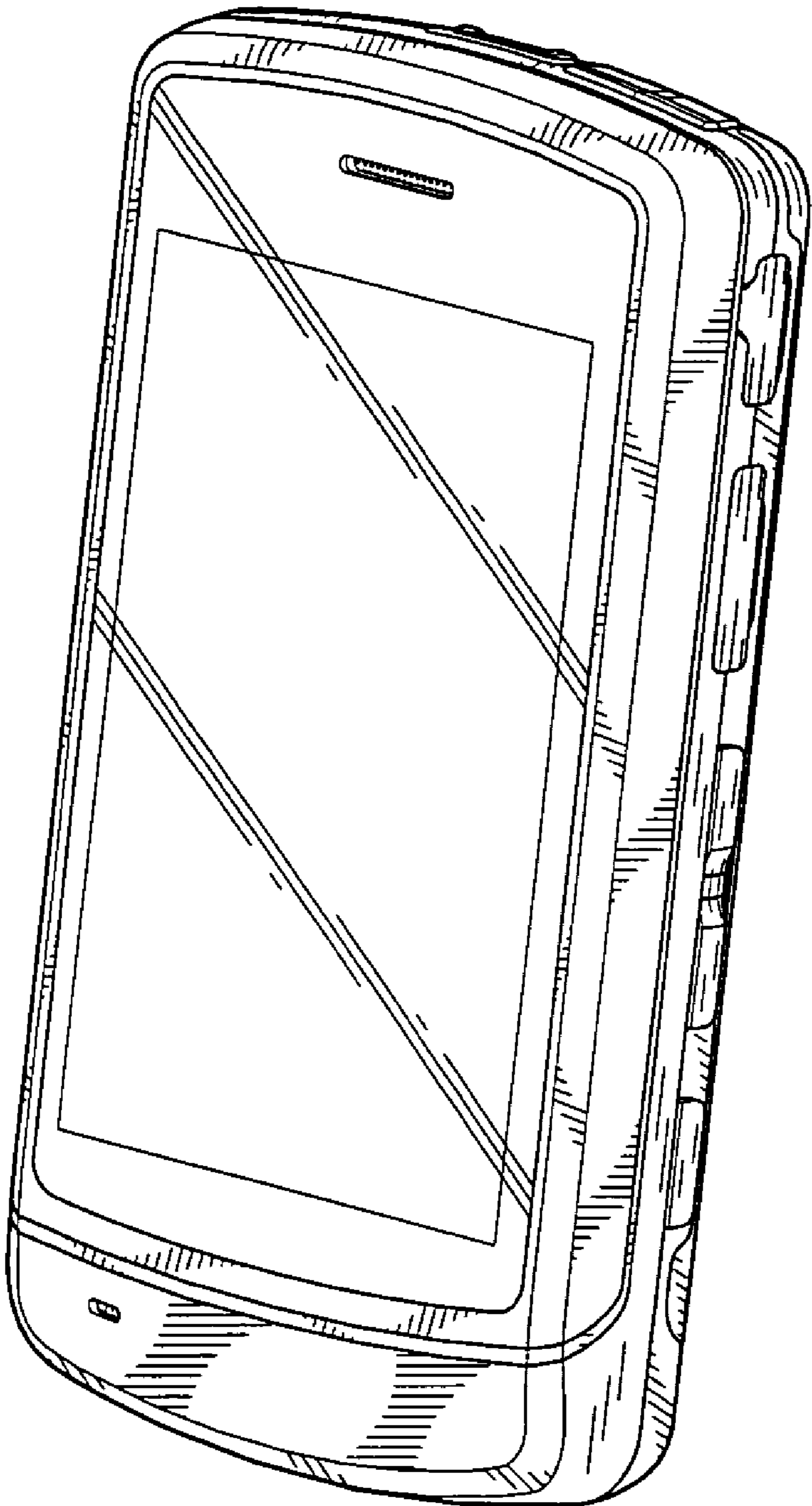

FIG. 2

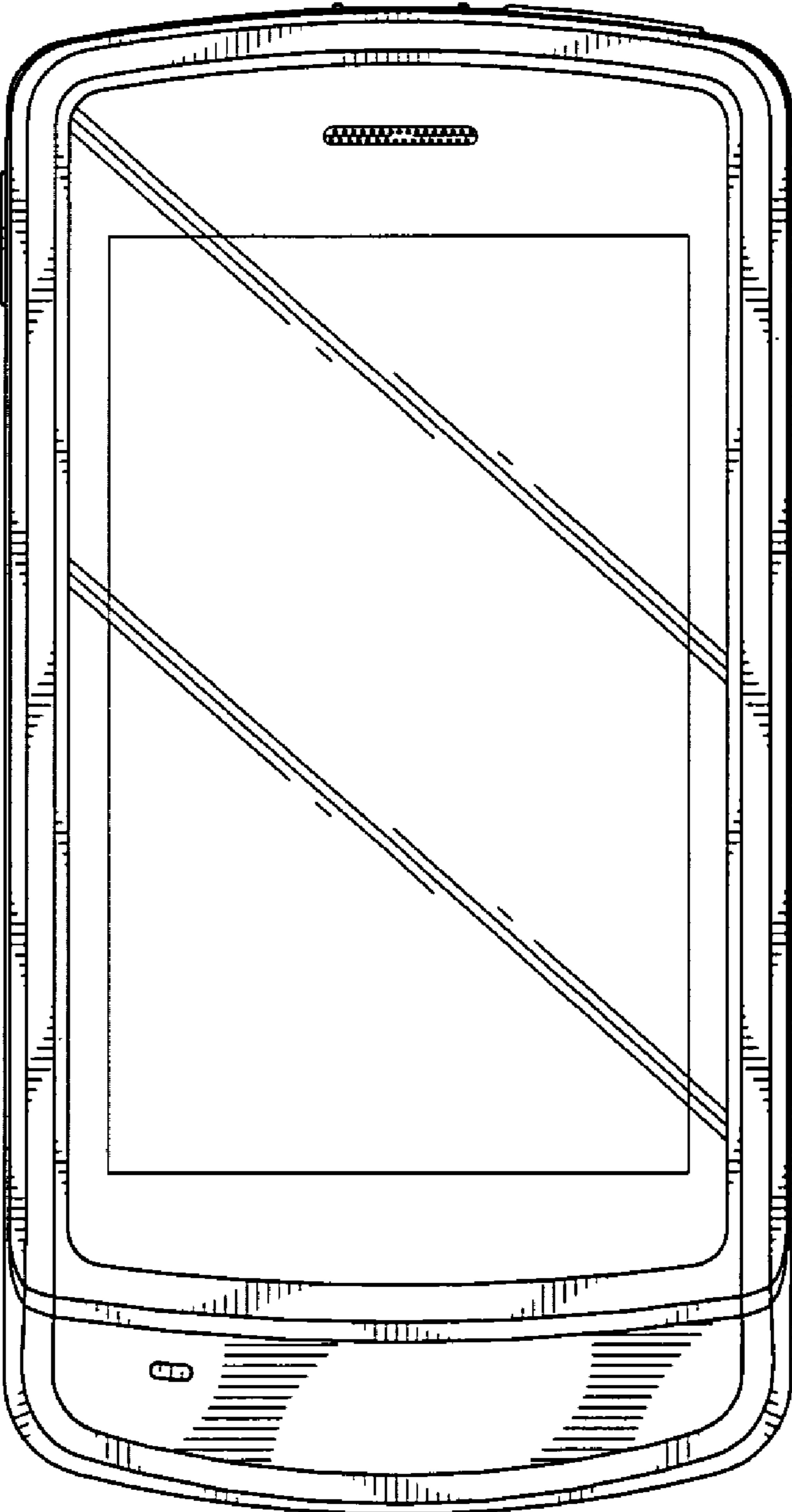

FIG. 3

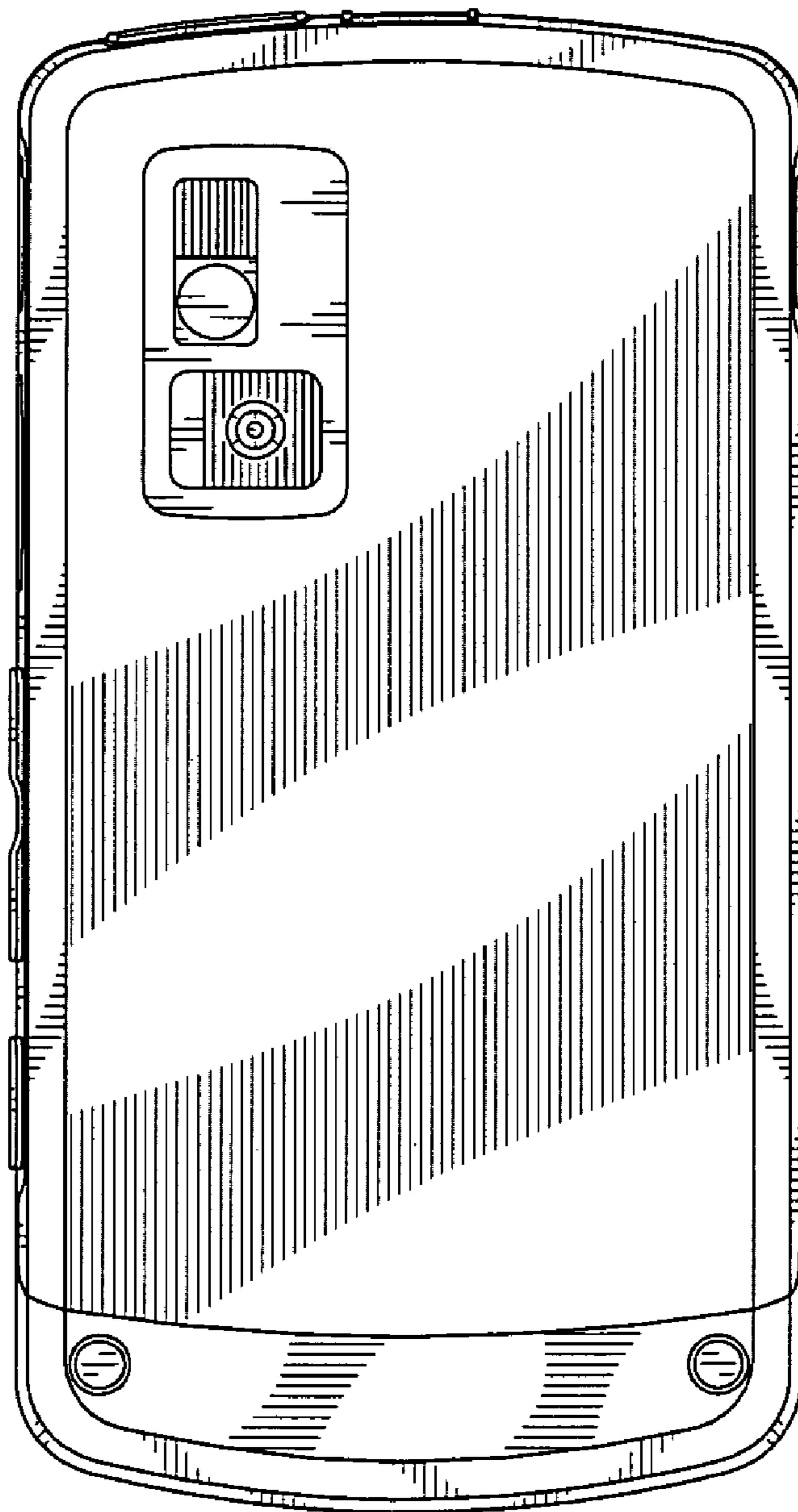

FIG. 4

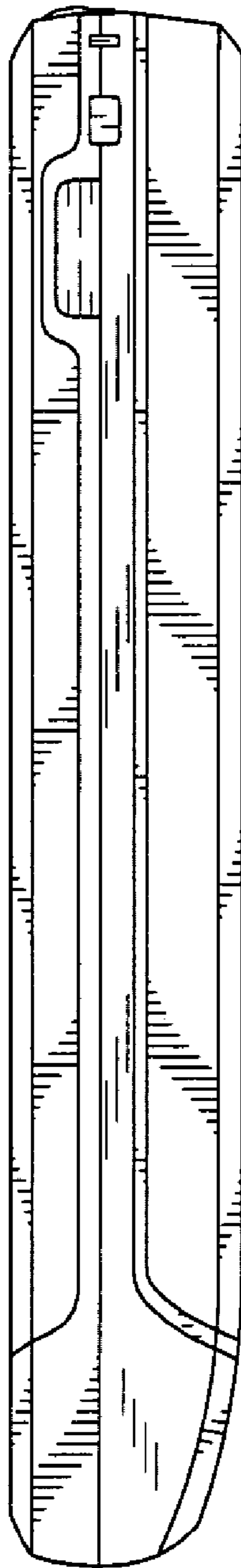

FIG. 5

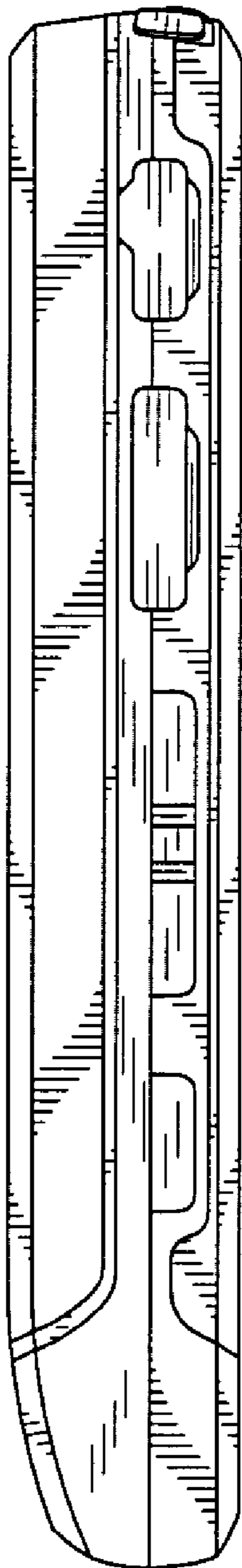

FIG. 6

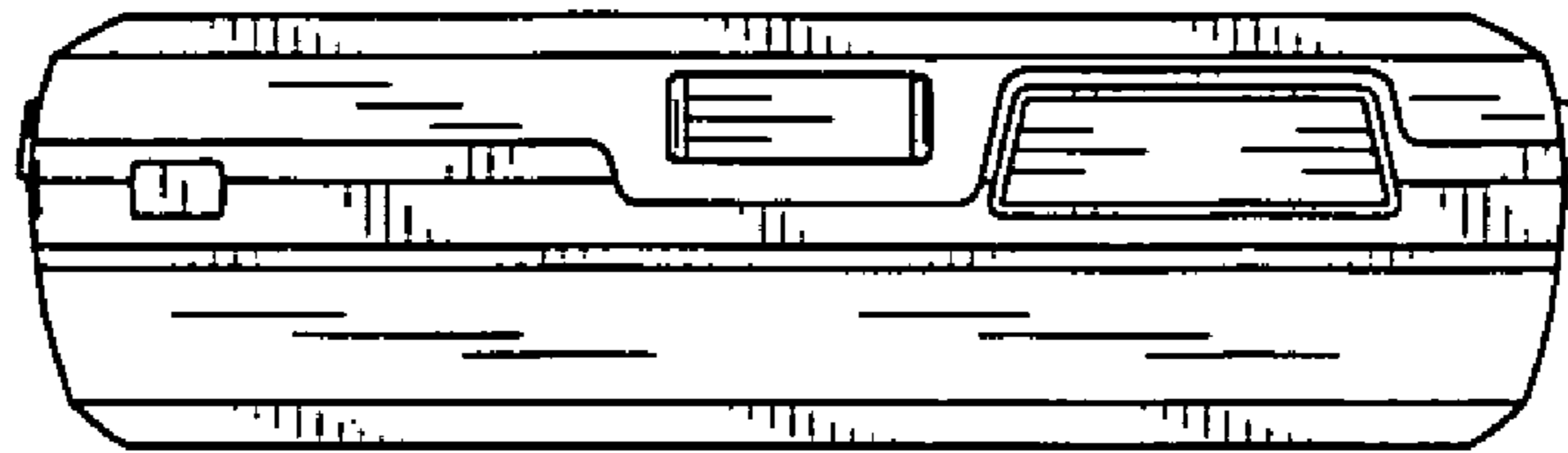

FIG. 7

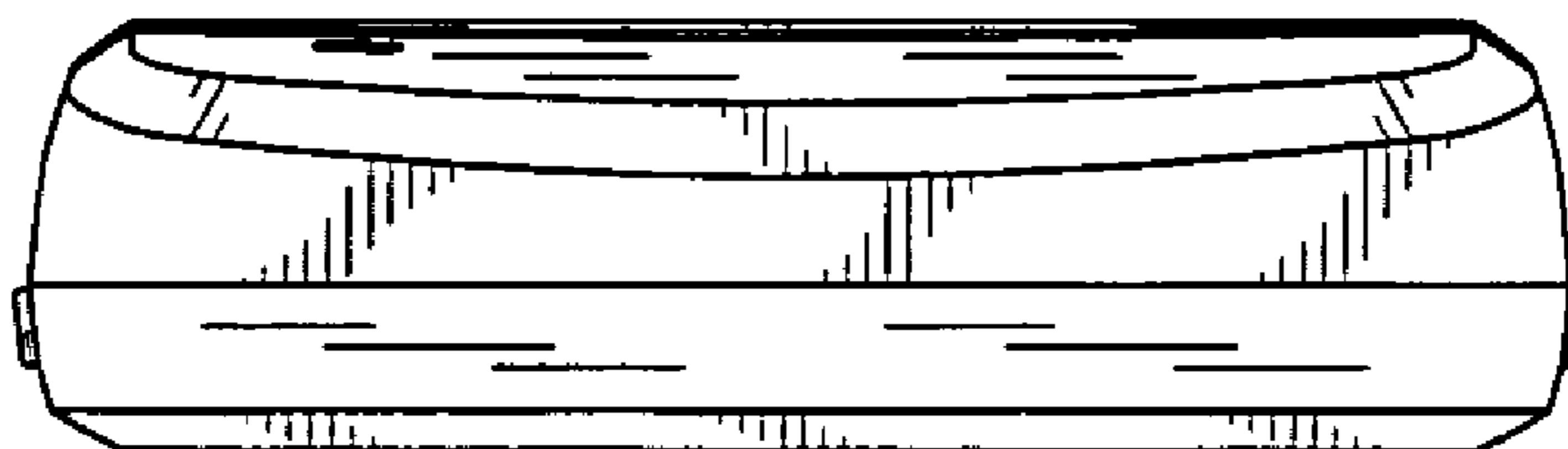

FIG. 8

