



US00D594320S

(12) **United States Design Patent**
Tanaka et al.

(10) **Patent No.:** **US D594,320 S**
(45) **Date of Patent:** **** Jun. 16, 2009**

(54) **PACKAGE**

(75) Inventors: **Richard Tanaka**, Astoria, NY (US);
David Lutness, Belle Mead, NJ (US);
Laszlo Moharita, Hoboken, NJ (US);
Steven J. Hecht, Wyckoff, NJ (US);
Karin Taylor, New York, NY (US);
Anthony Trumbauer, Portland, PA (US)

(73) Assignee: **McNeil - PPC, Inc.**, Skillman, NJ (US)

(**) Term: **14 Years**

(21) Appl. No.: **29/301,289**

(22) Filed: **Feb. 21, 2008**

(51) **LOC (9) Cl.** **09-03**

(52) **U.S. Cl.** **D9/420; D9/434**

(58) **Field of Classification Search** D9/414,
D9/420-424, 428, 434, 387; 206/265-268,
206/276, 457; D28/66; 220/834-843; 229/87.13,
229/160.1, 116.1

See application file for complete search history.

(56) **References Cited**

U.S. PATENT DOCUMENTS

D271,431 S *	11/1983	Seelig	D28/66
D317,407 S	6/1991	Gray et al.		
D404,644 S *	1/1999	Meeker	D9/415
D417,311 S	11/1999	Hester		
D438,459 S	3/2001	Holthaus		
D449,521 S *	10/2001	Pinkus et al.	D9/424
D462,613 S *	9/2002	Bried et al.	D9/428
D467,799 S *	12/2002	Persson	D9/420
D475,282 S	6/2003	Snaith et al.		
D493,257 S	7/2004	McCorkindale		
D493,576 S	7/2004	Ward		
D510,461 S	10/2005	Vu		
D513,584 S *	1/2006	Solowiejko et al.	D9/417
D523,743 S *	6/2006	Solowiejko et al.	D9/417
D544,150 S	6/2007	Aledo et al.		
D548,887 S	8/2007	Aledo et al.		
D553,795 S *	10/2007	Tran	D28/66

D554,986 S *	11/2007	Galesi	D9/424
D554,987 S *	11/2007	Terrasi	D9/424
D557,134 S *	12/2007	Wolpert et al.	D9/414
D559,705 S	1/2008	Sparks et al.		
D562,152 S	2/2008	Beam et al.		
D568,736 S *	5/2008	Born et al.	D9/424

OTHER PUBLICATIONS

Trident Gum Packaging Photos, Brazil, (at least as early as 2007).
Trademark Registration No. 2,993,471 Registered Sep. 6, 2005
(Hershey Chocolate & Confectionery Corp.).

* cited by examiner

Primary Examiner—Daniel D Bui

Assistant Examiner—Thomas J Johannes

(74) *Attorney, Agent, or Firm*—Karen G. Horowitz

(57) **CLAIM**

We claim the ornamental design for a package, as shown and described.

DESCRIPTION

FIG. 1 is a top, front and right side perspective view of a package showing our new design;

FIG. 2 is a front view thereof;

FIG. 3 is a back view thereof;

FIG. 4 is a left side view thereof; the right side view being a mirror image thereof;

FIG. 5 is a top view thereof;

FIG. 6 is a bottom view thereof; and,

FIG. 7 is a top, front and right side perspective view thereof in an open use position.

The broken lines in the drawings are for illustrative purposes only and form no part of the claimed design. The double-dash broken lines in the drawings delineate the boundaries of the claimed subject matter, wherein the claimed subject matter includes shading and the unclaimed subject matter does not include shading.

1 Claim, 5 Drawing Sheets

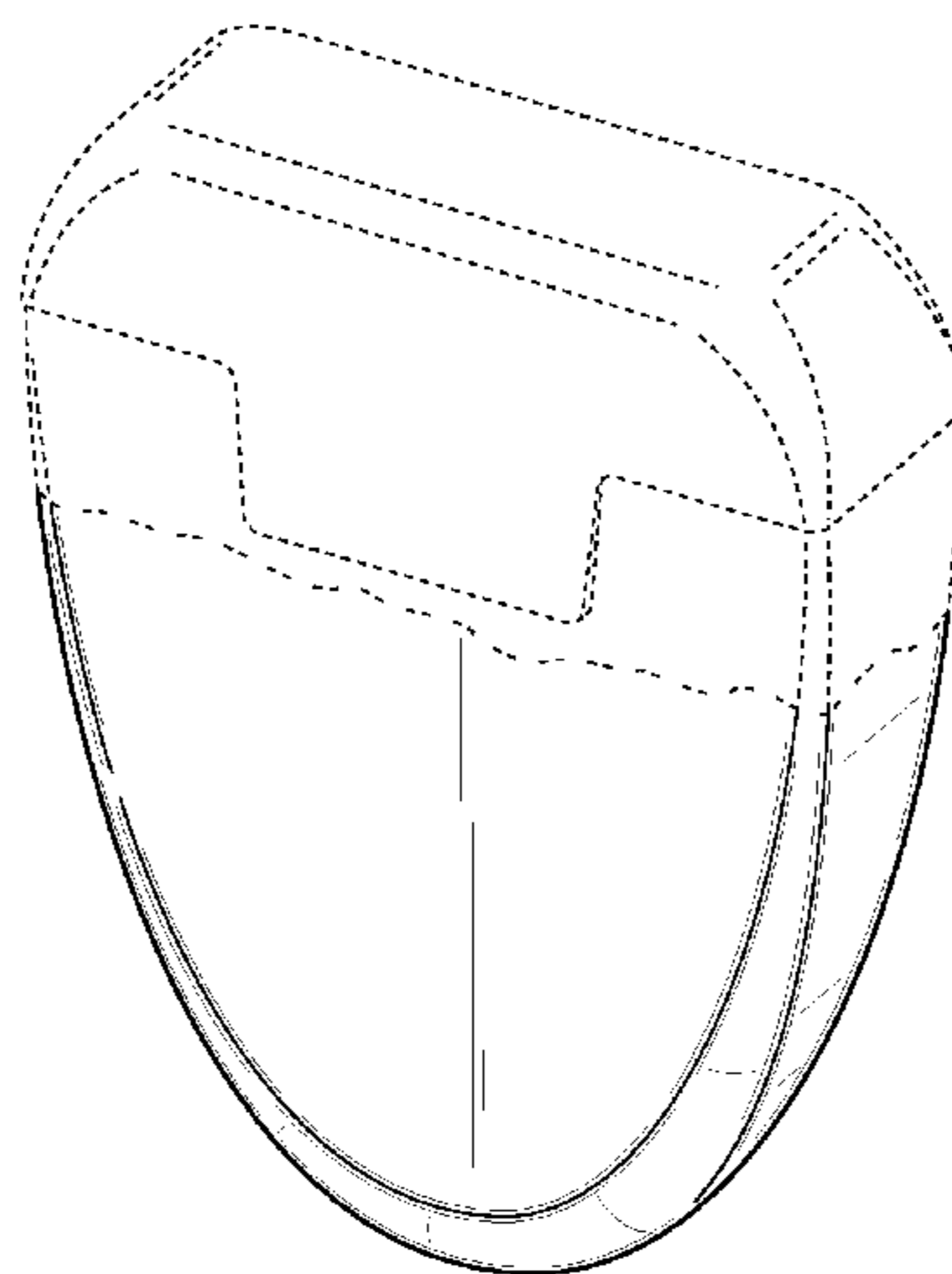

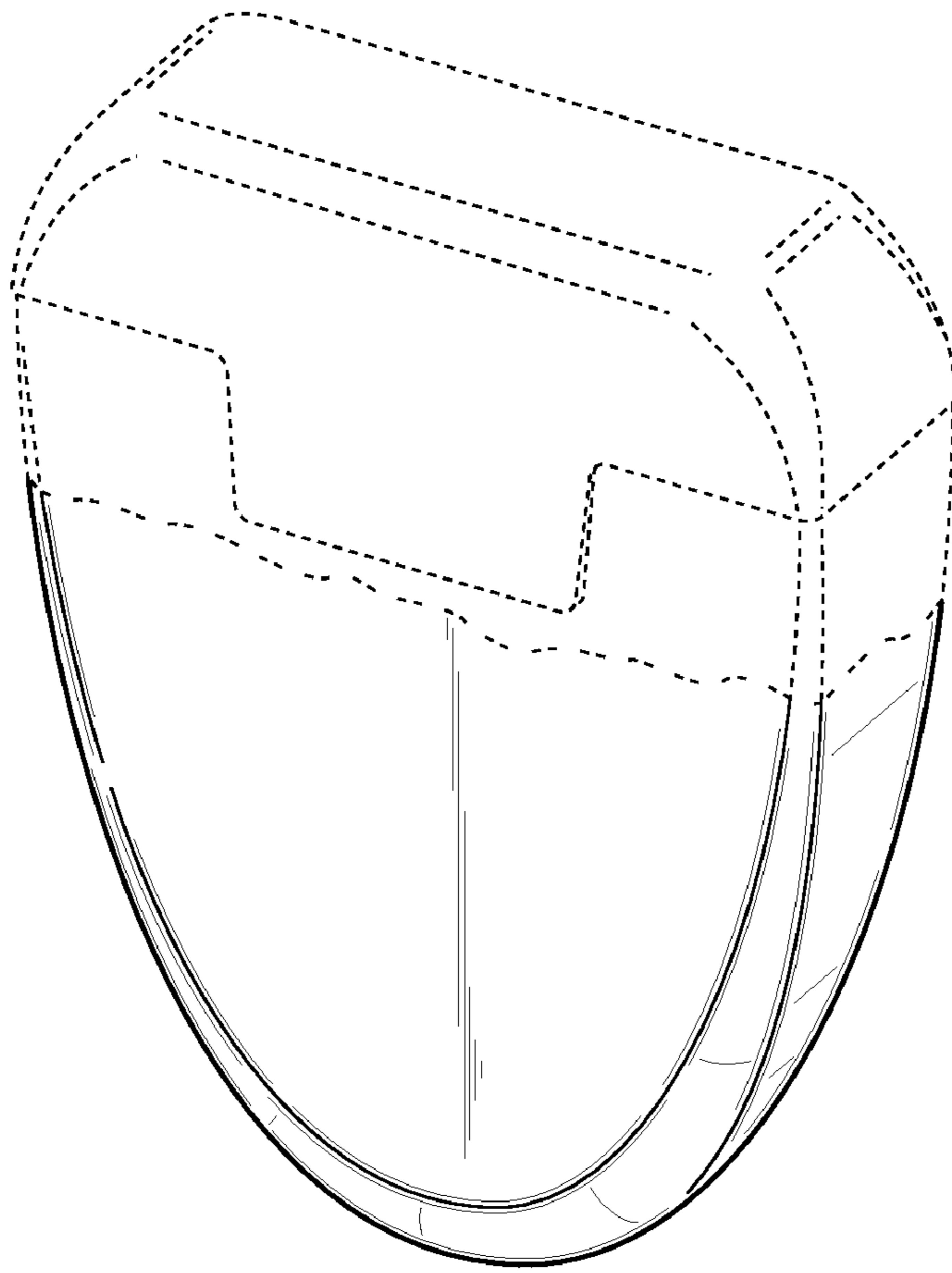

Fig. 1

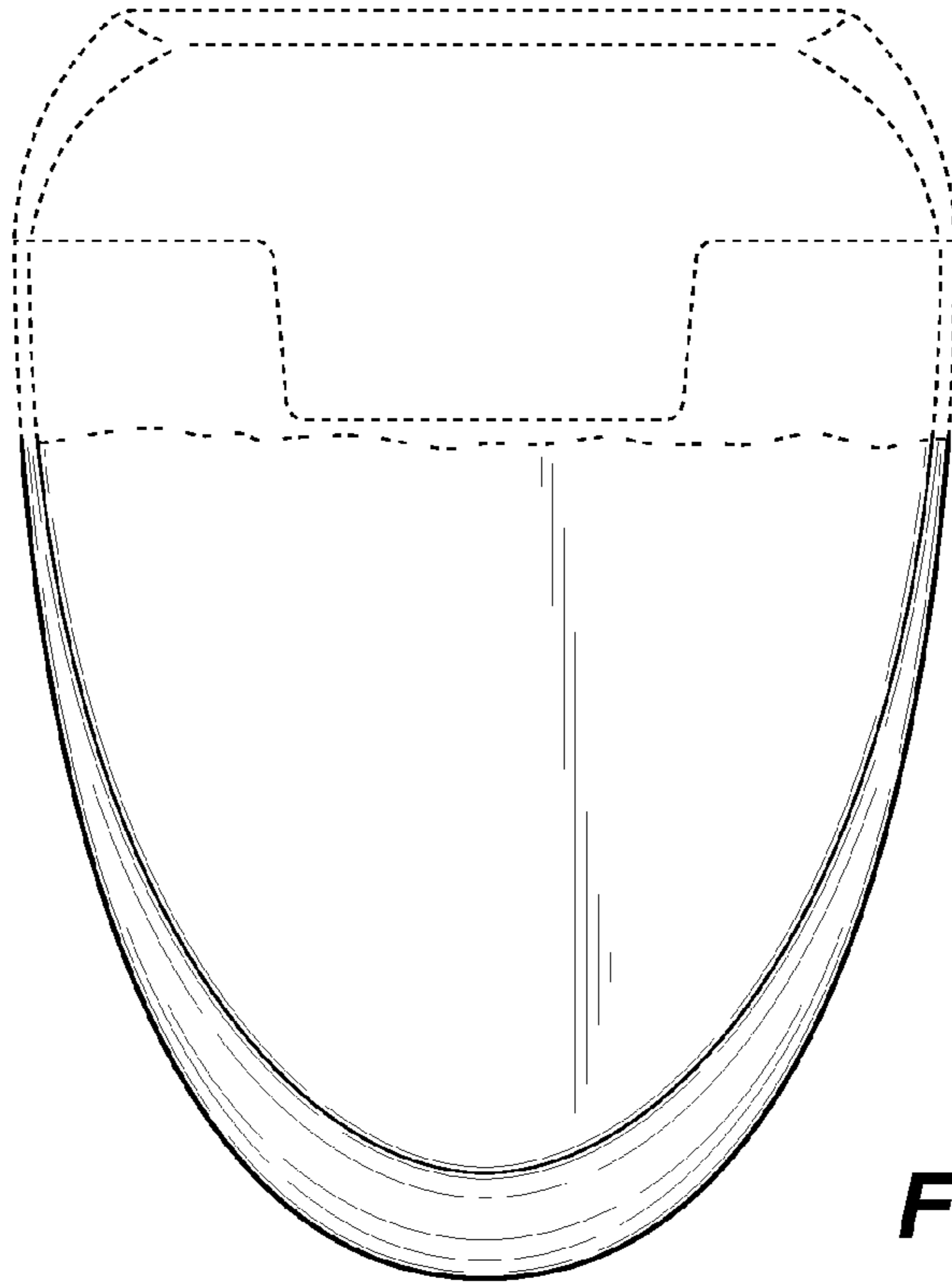

Fig. 2

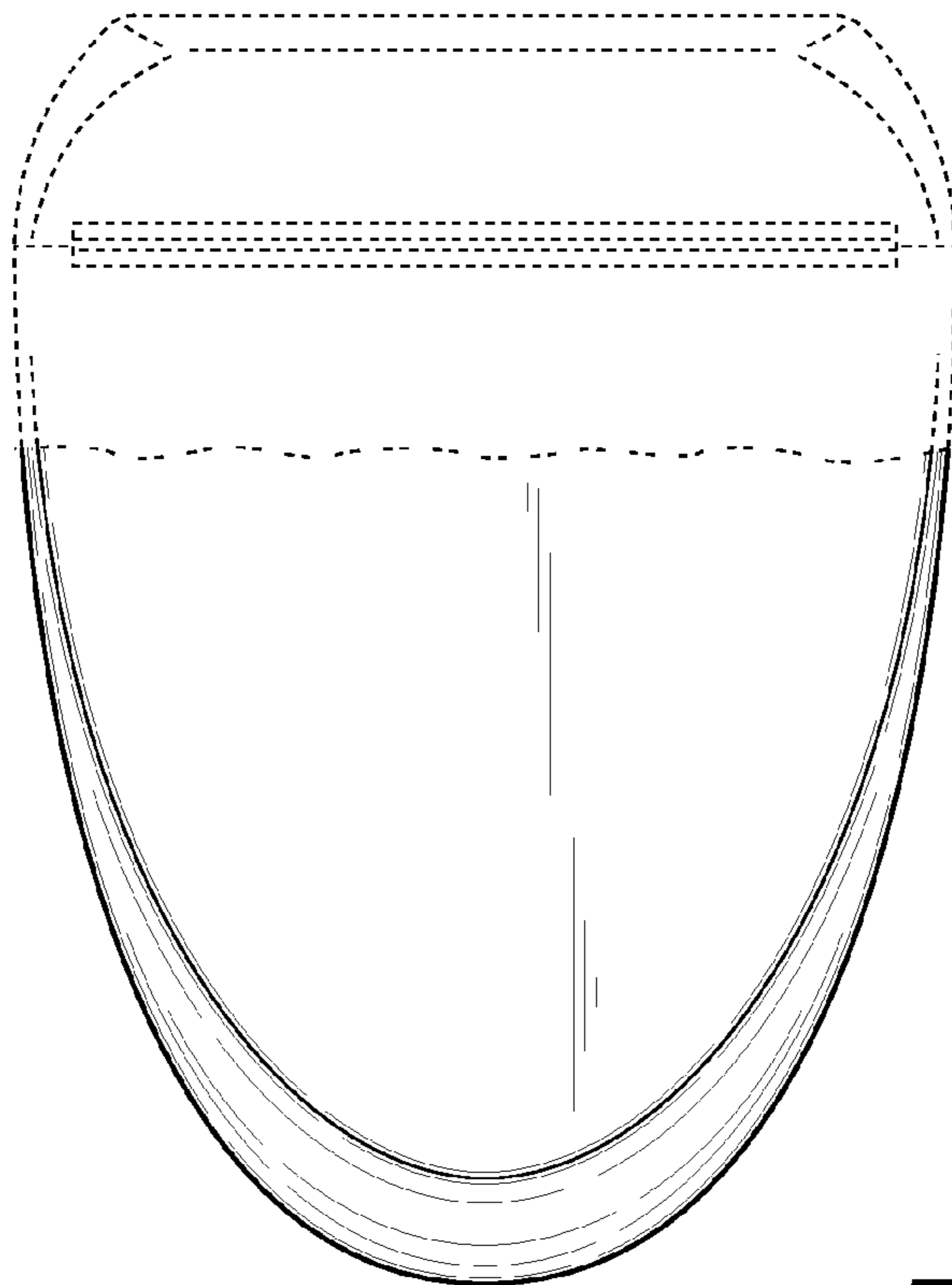

Fig. 3

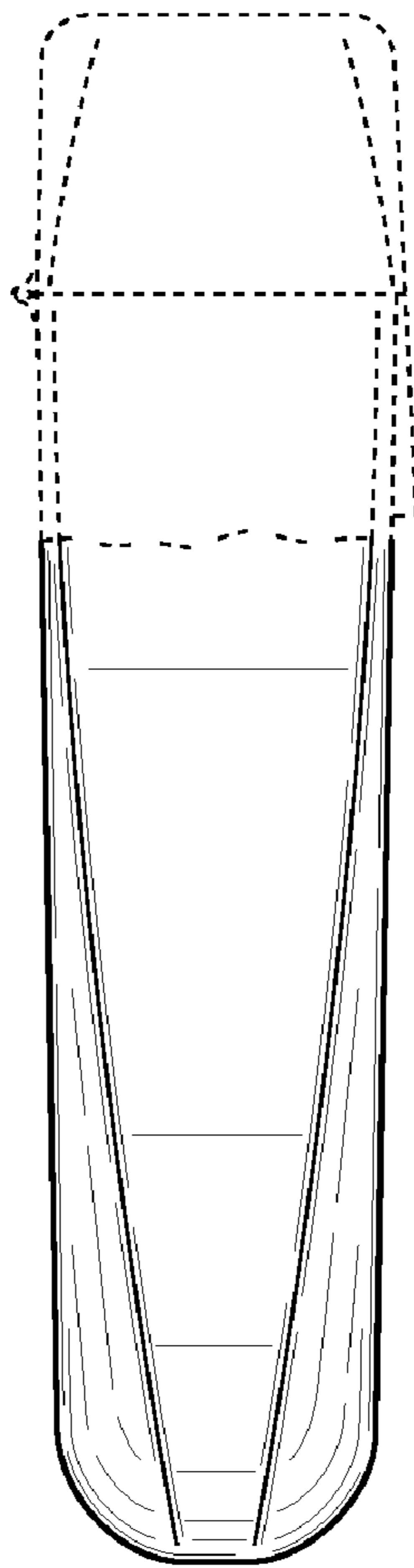

Fig. 4

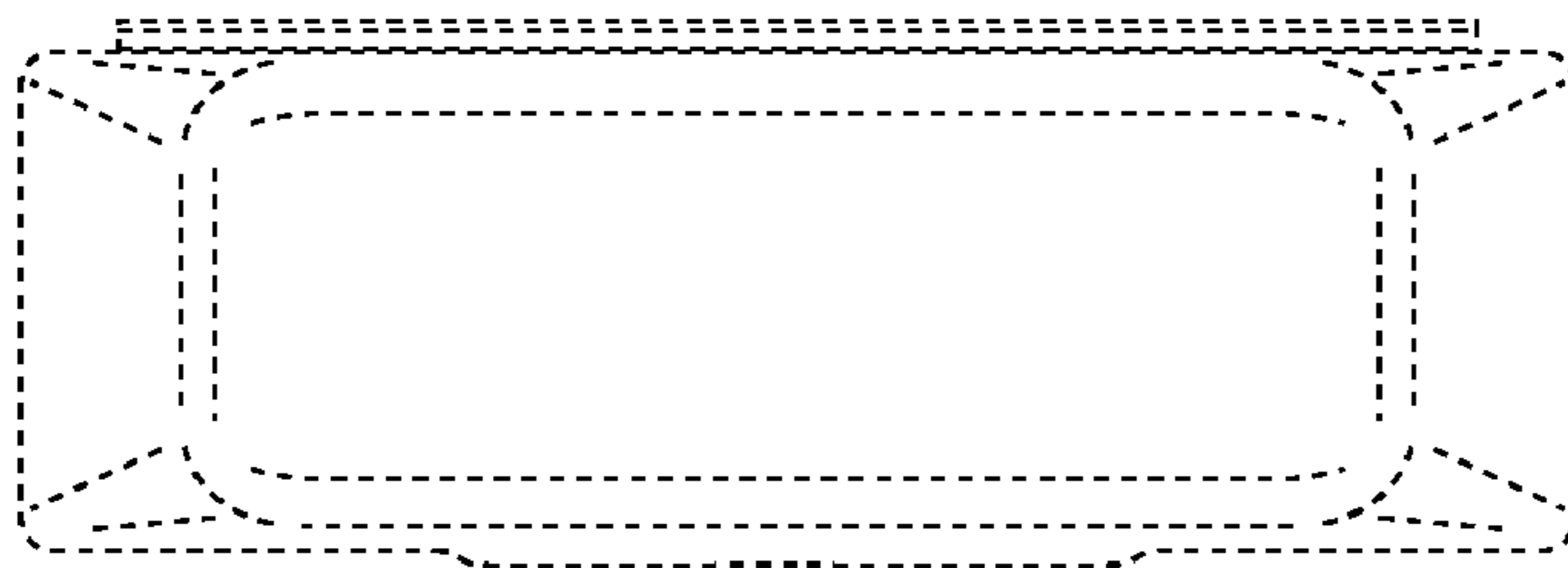

Fig. 5

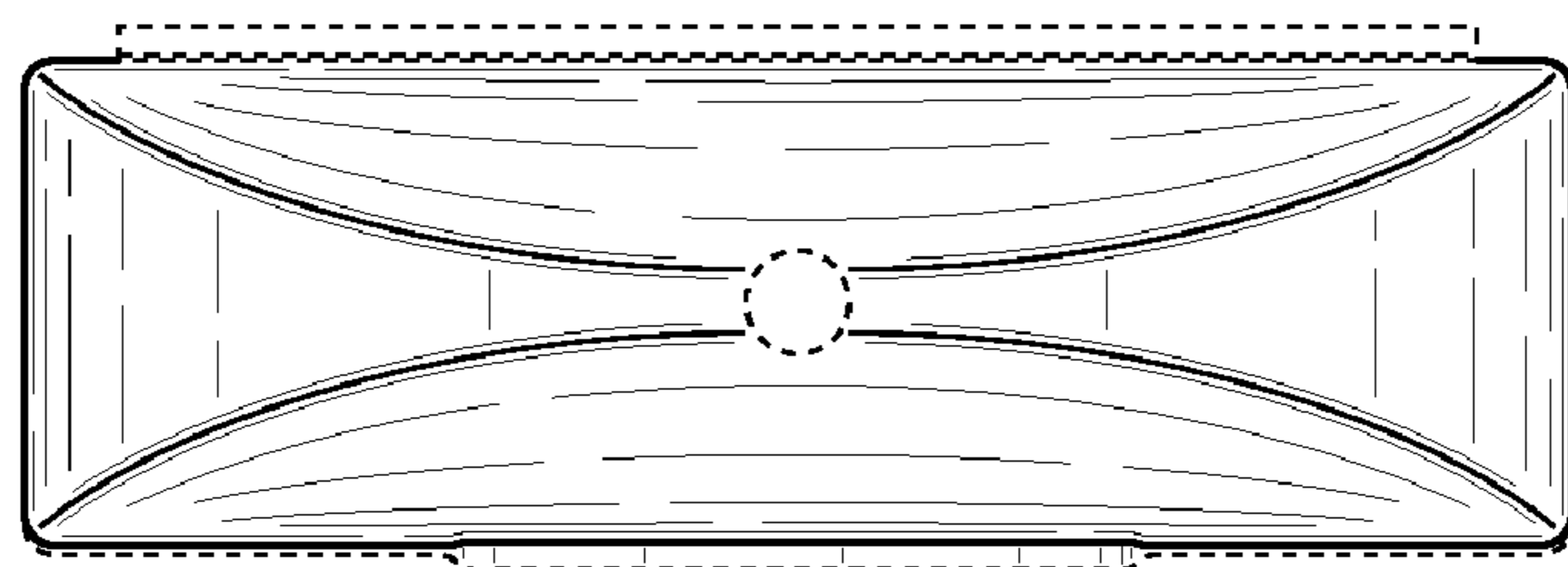

Fig. 6

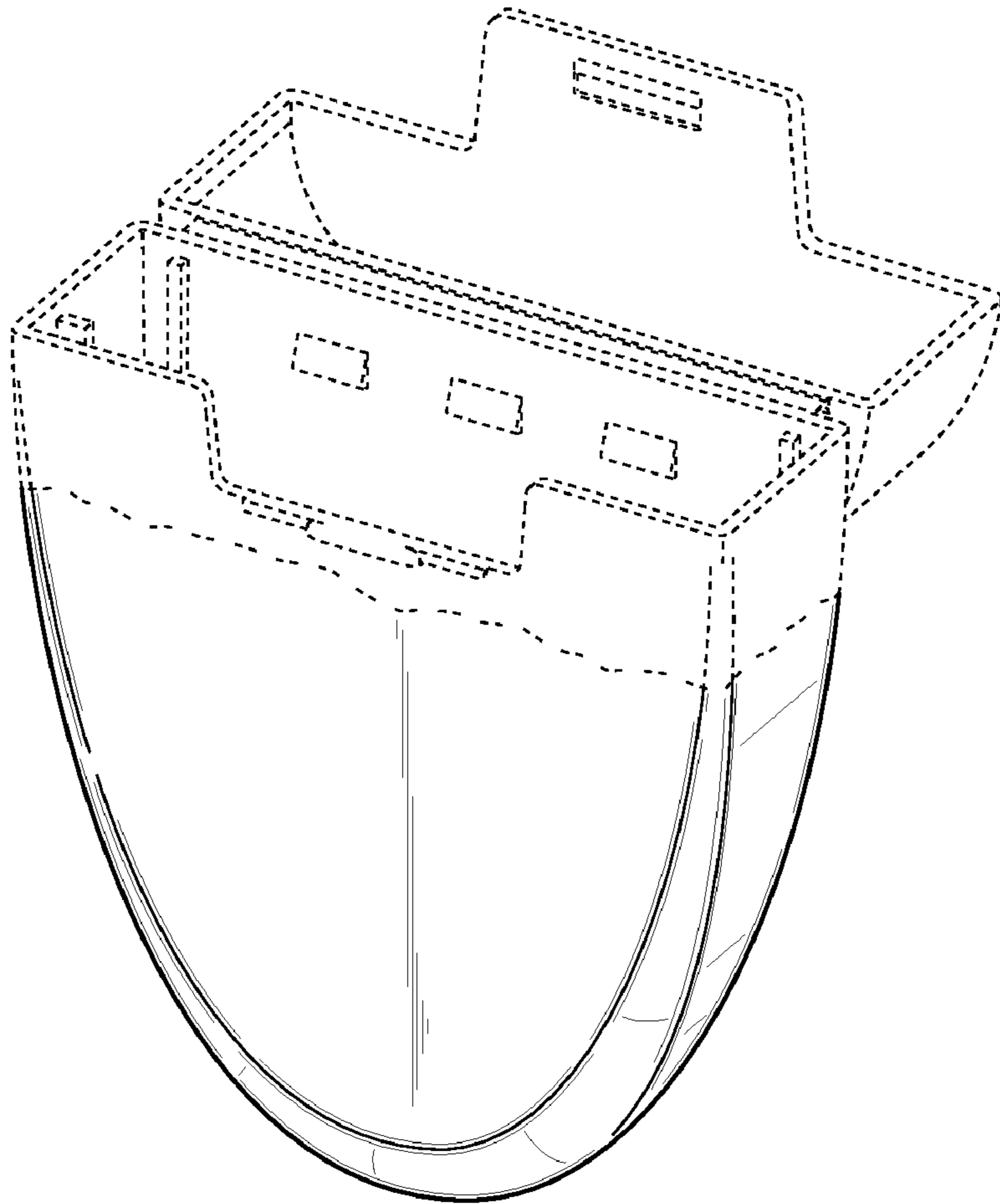

Fig. 7