



US00D594289S

(12) **United States Design Patent**
Krus

(10) **Patent No.:** **US D594,289 S**

(45) **Date of Patent:** **** Jun. 16, 2009**

(54) **GRATER**

(75) Inventor: **Matthew Krus**, Seattle, WA (US)

(73) Assignee: **Chef'n Corporation**, Seattle, WA (US)

(**) Term: **14 Years**

(21) Appl. No.: **29/322,735**

(22) Filed: **Aug. 11, 2008**

(51) **LOC (9) Cl.** **07-04**

(52) **U.S. Cl.** **D7/678**

(58) **Field of Classification Search** D7/612-615,
D7/628, 602, 606; D9/643, 644, 428, 429;
206/457; 241/93, 95, 273.1-273.4, 280-282,
241/168, 169, 169.1

See application file for complete search history.

(56) **References Cited**

U.S. PATENT DOCUMENTS

3,858,815 A * 1/1975 Black 241/168
3,912,176 A * 10/1975 Mantelet 241/93
6,464,156 B1 * 10/2002 Wexell 241/93
D476,864 S * 7/2003 Daldosso D7/678

6,766,972 B1 * 7/2004 Prommel et al. 241/93
7,137,581 B2 * 11/2006 Takayama et al. 241/169.1

* cited by examiner

Primary Examiner—Terry A Wallace

(74) *Attorney, Agent, or Firm*—Seed IP law Group PLLC

(57) **CLAIM**

The ornamental design for a grater, as shown and described.

DESCRIPTION

FIG. 1 is an isometric view of for a grater showing my new design.

FIG. 2 is a front elevation view thereof.

FIG. 3 is a rear elevation view thereof.

FIG. 4 is a top plan view thereof.

FIG. 5 is a bottom plan view thereof.

FIG. 6 is a left side elevation view thereof; and,

FIG. 7 is a right side elevation view thereof.

The broken lines in the figures are for illustrative purposes only and form no part of the claimed design.

1 Claim, 6 Drawing Sheets

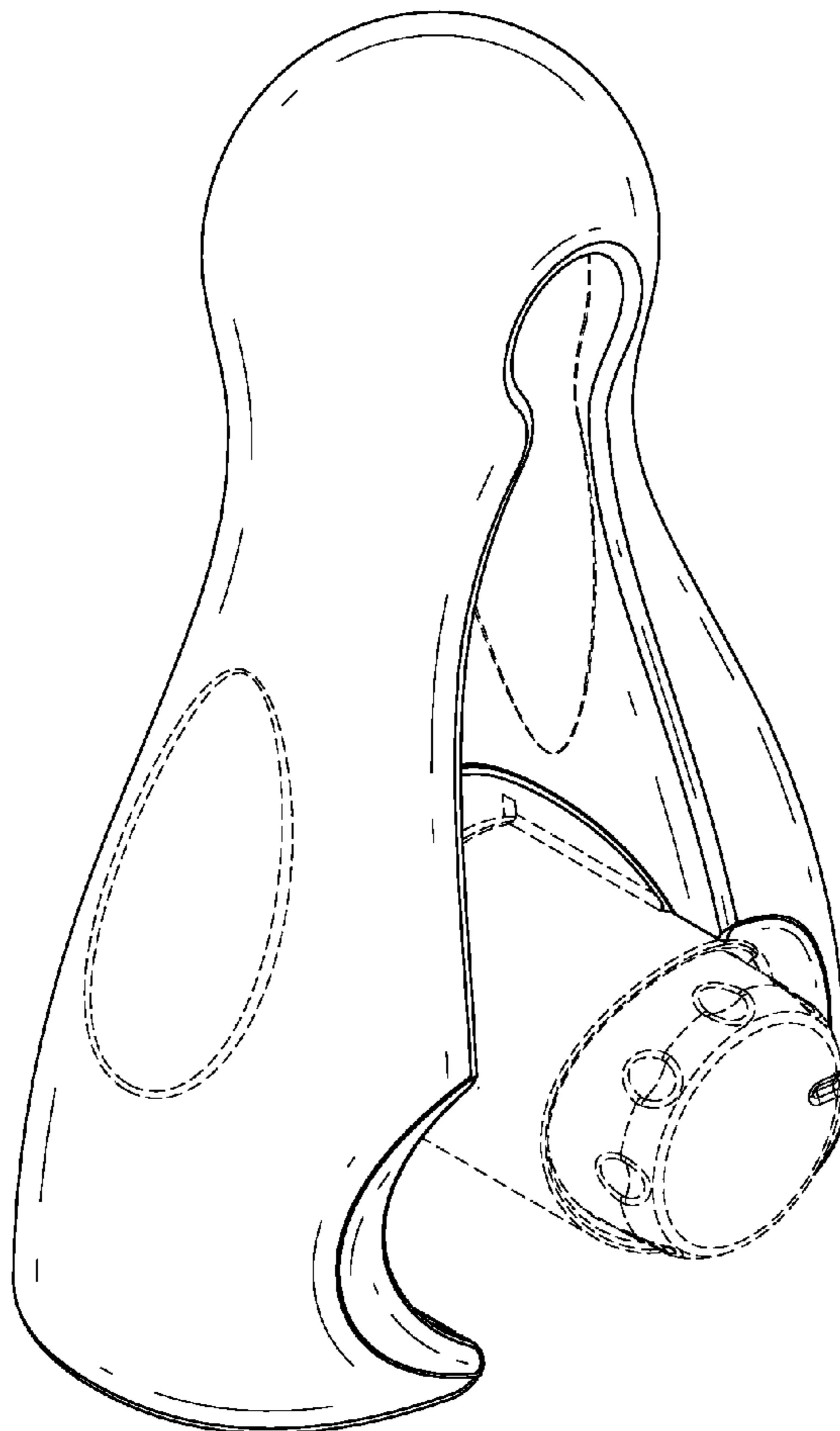

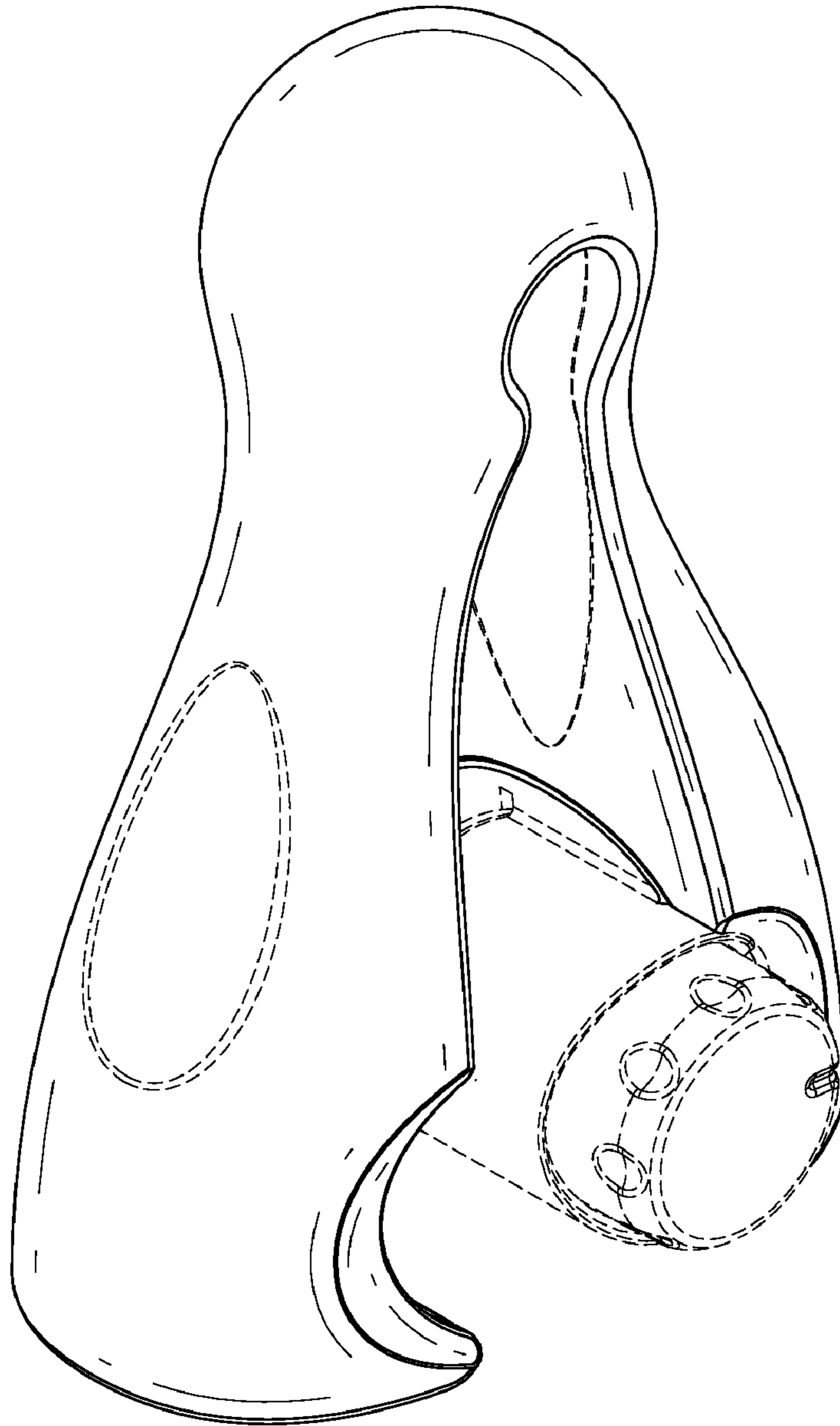

FIG. 1

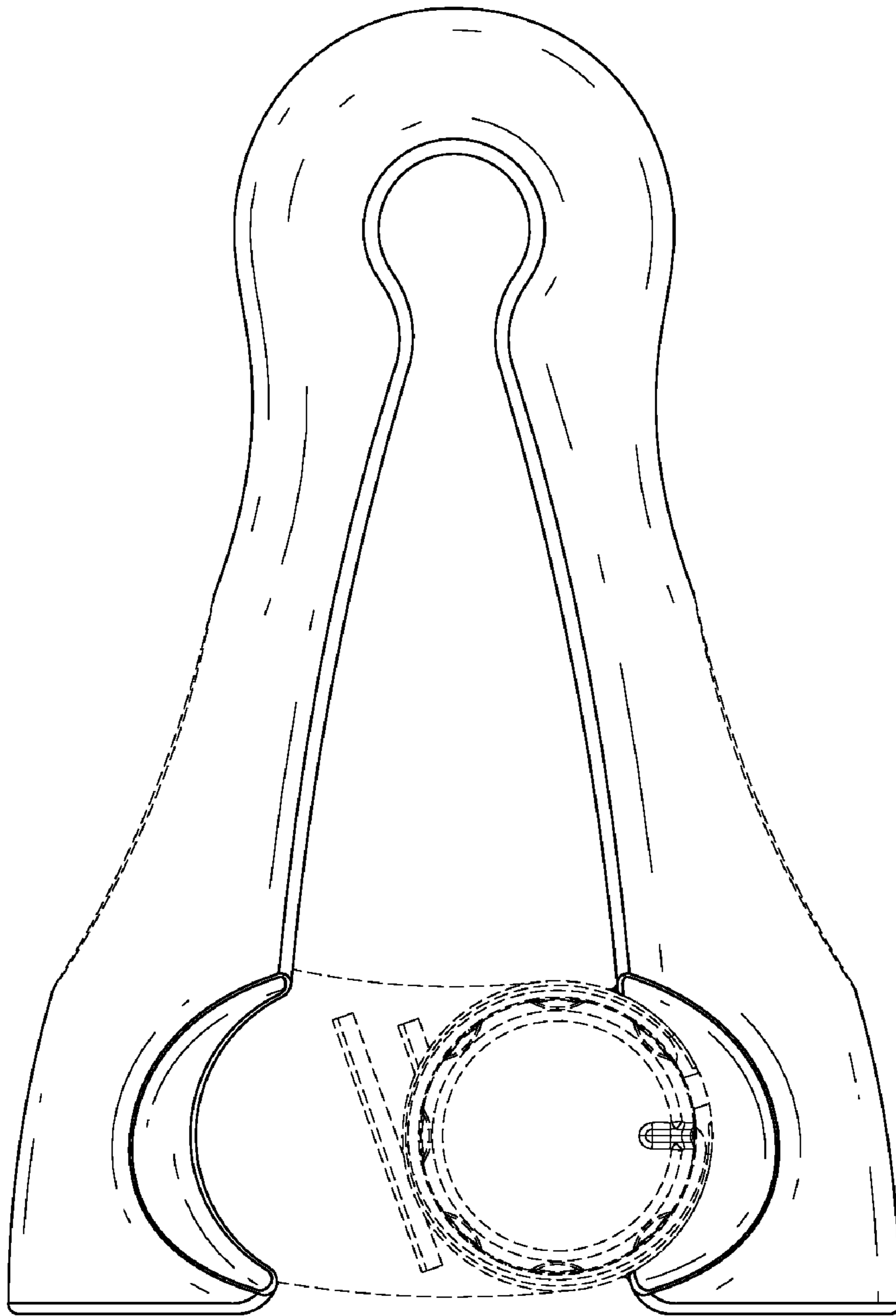

FIG. 2

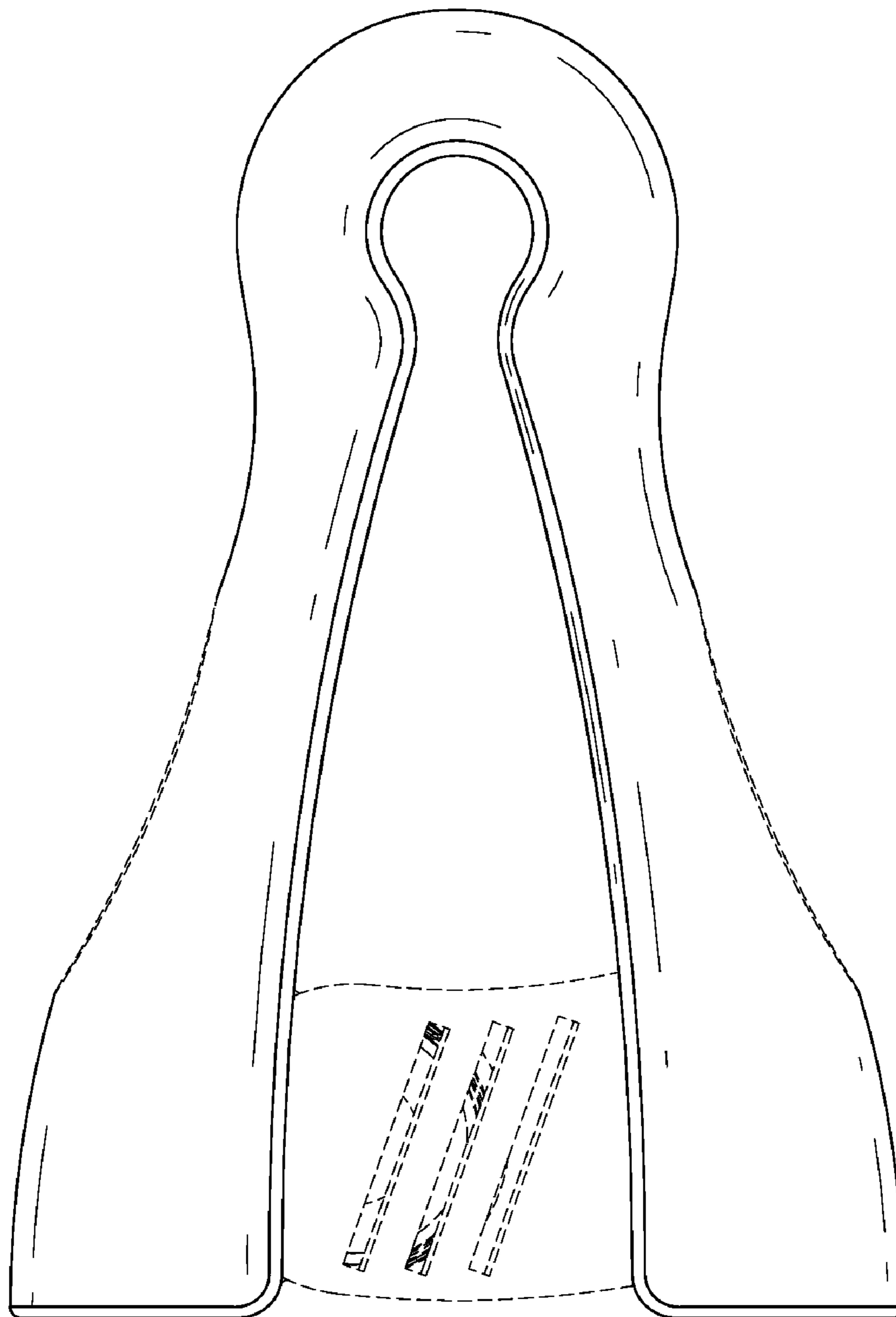

FIG. 3

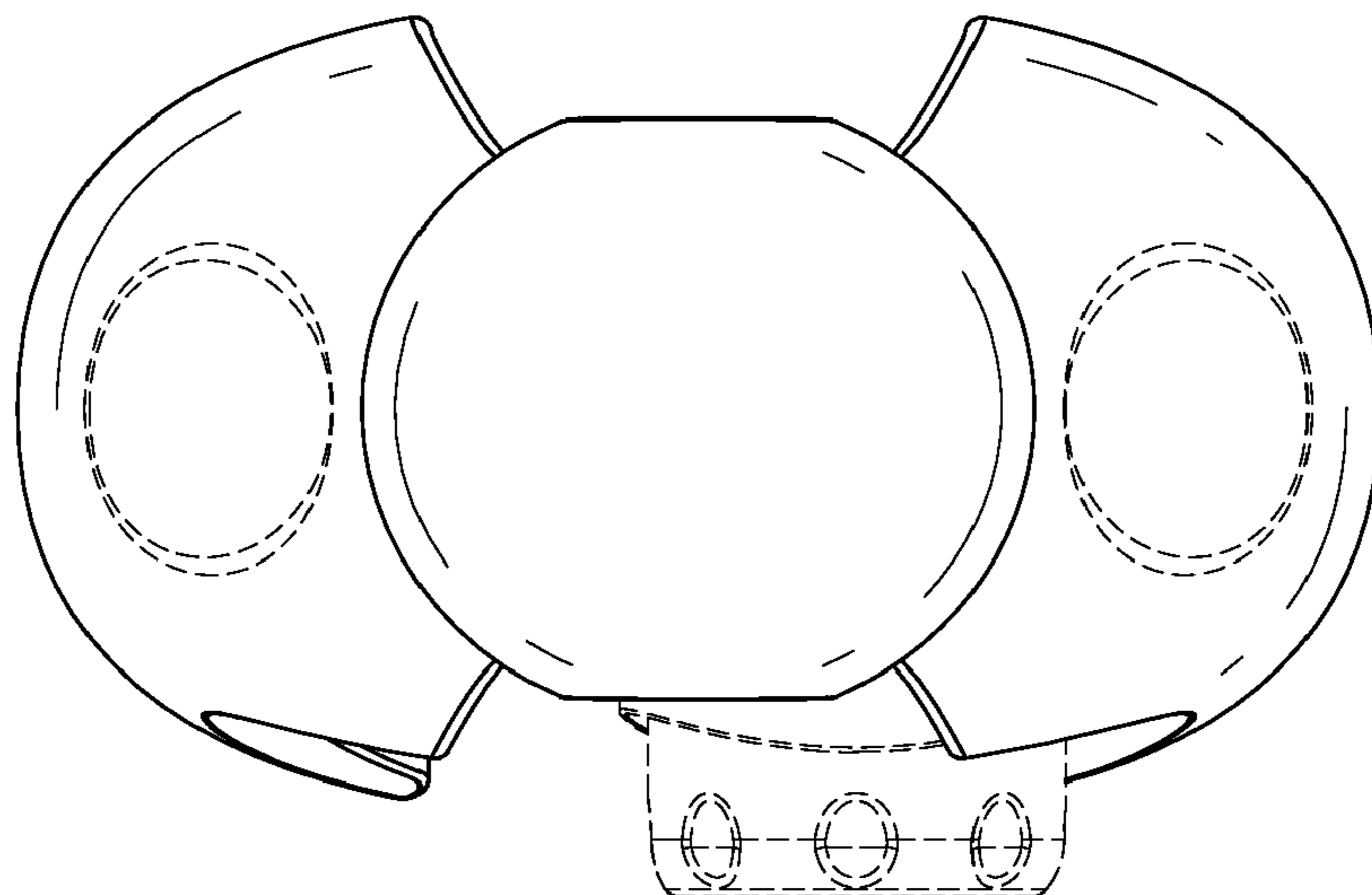

FIG. 4

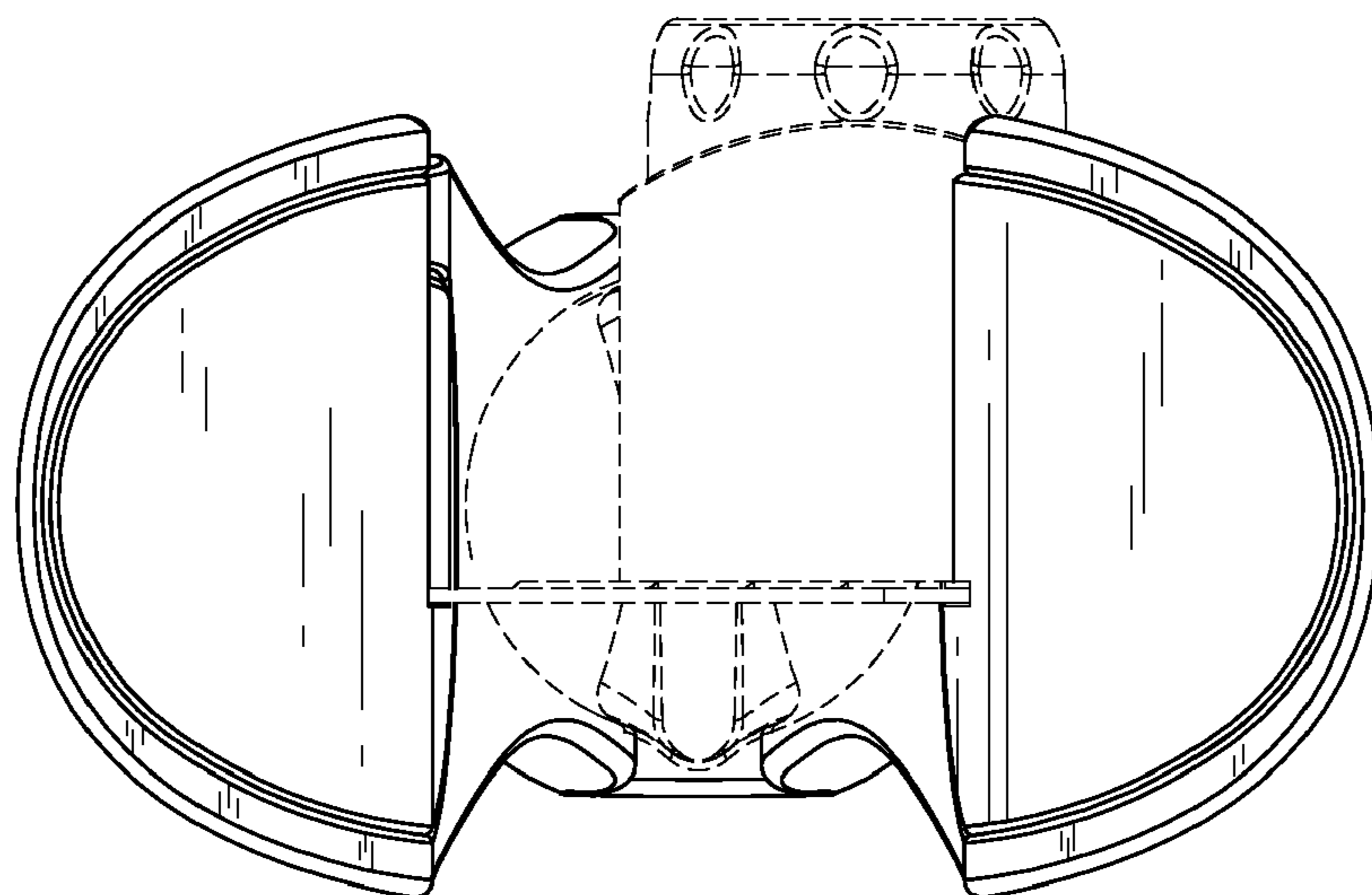

FIG. 5

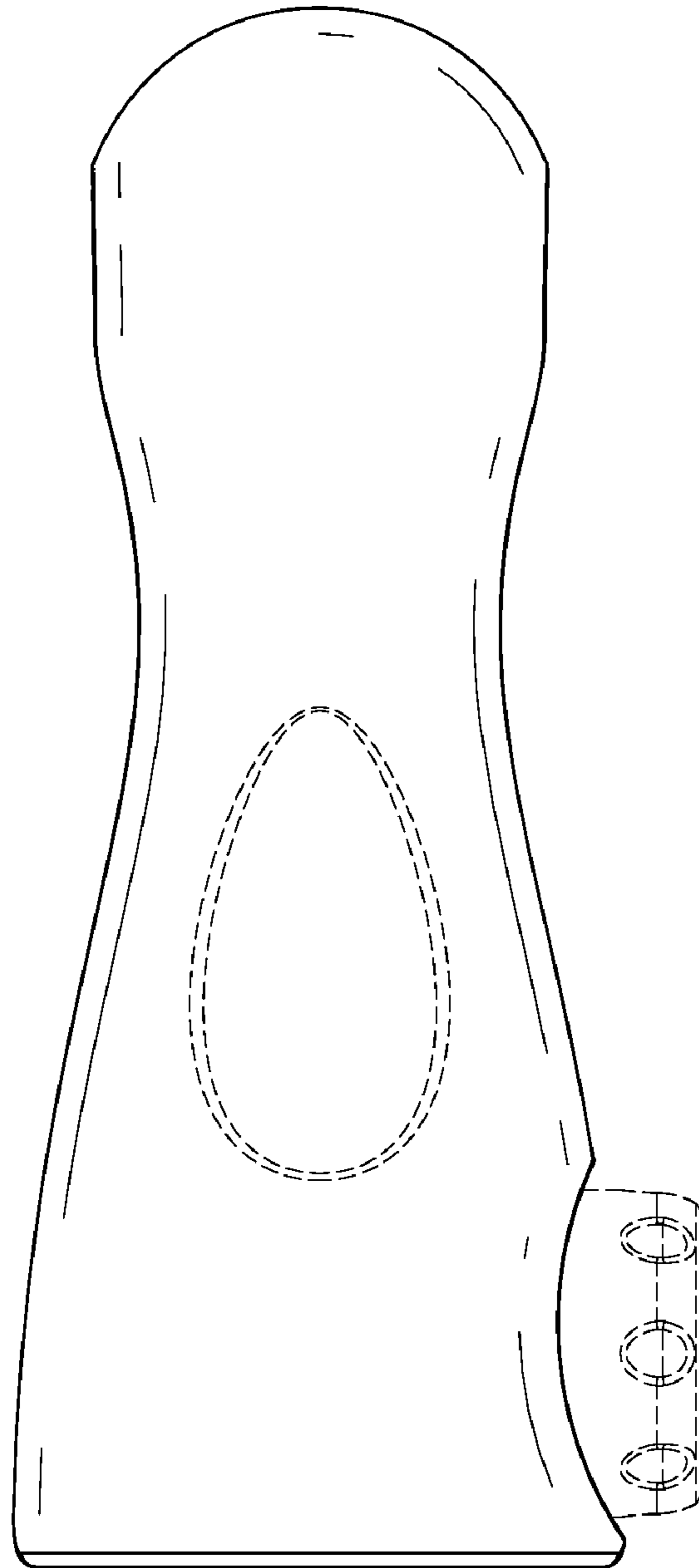

FIG. 6

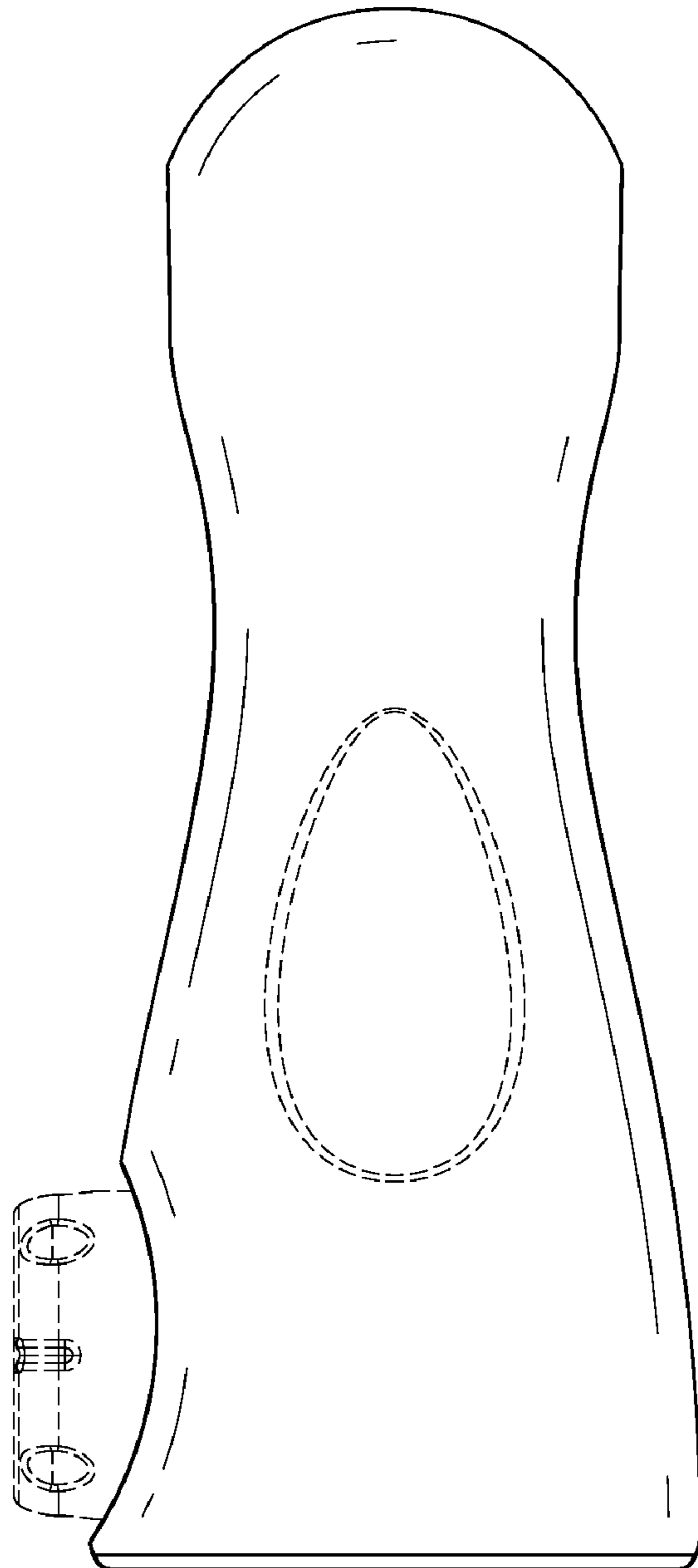

FIG. 7