



US00D594242S

(12) **United States Design Patent**
Sweeney

(10) **Patent No.:** **US D594,242 S**
(45) **Date of Patent:** **** Jun. 16, 2009**

- (54) **BARREL TYPE CHAIR**
 - (75) Inventor: **Shaun Sweeney**, Oak Forest, IL (US)
 - (73) Assignee: **Woodard--CM, LLC**, Chicago, IL (US)
 - (**) Term: **14 Years**
 - (21) Appl. No.: **29/279,407**
 - (22) Filed: **Apr. 30, 2007**
 - (51) **LOC (9) Cl.** **06-01**
 - (52) **U.S. Cl.** **D6/376**
 - (58) **Field of Classification Search** D6/364-369,
D6/334-336, 356, 358, 361, 370, 372-376,
D6/379, 380, 449, 491, 492, 495, 498, 500-502;
297/411.2, 411.27, 411.28, 411.36, 452.29,
297/284.4, 452.3
- See application file for complete search history.

- D557,031 S * 12/2007 Marin D6/376
- D585,658 S * 2/2009 Dauphin D6/380
- D586,142 S * 2/2009 Camp et al. D6/372

OTHER PUBLICATIONS

- Woodard Brochure—Windflower Mesh—1997.
- Woodard Brochure—Cantebury—1997.
- Woodard Brochure—Sheffield—1994.
- Woodard Brochure—Briarwood—1988.
- Woodard Brochure—Valencia—1987.

* cited by examiner

Primary Examiner—Caron Veynar
Assistant Examiner—Katrina A Kile

(74) *Attorney, Agent, or Firm*—Haynes and Boone, LLP

(57) **CLAIM**

The ornamental design for a barrel type chair, as shown and described.

DESCRIPTION

FIG. 1 is a top plan view of a barrel type chair showing the new design;

FIG. 2 is a front perspective view thereof;

FIG. 3 is a front view thereof;

FIG. 4 is a right side perspective view thereof;

FIG. 5 is a left side perspective view thereof;

FIG. 6 is a rear perspective view thereof;

FIG. 7 is a bottom plan view thereof; and,

FIG. 8 is a bottom perspective view thereof.

1 Claim, 8 Drawing Sheets

(56) **References Cited**

U.S. PATENT DOCUMENTS

- D269,747 S * 7/1983 Wallace D6/376
- D286,827 S * 11/1986 Arthur, Jr. D6/376
- D326,137 S * 5/1992 Ali D23/225
- D368,810 S 4/1996 Kemnitz
- D386,910 S 12/1997 Saiger
- D526,136 S * 8/2006 Kettler et al. D6/376
- D532,986 S * 12/2006 Kettler et al. D6/376
- D540,057 S * 4/2007 Doughty D6/370
- D540,559 S * 4/2007 Neil D6/379
- D547,963 S * 8/2007 Olano D6/379
- D549,480 S * 8/2007 Rech D6/375

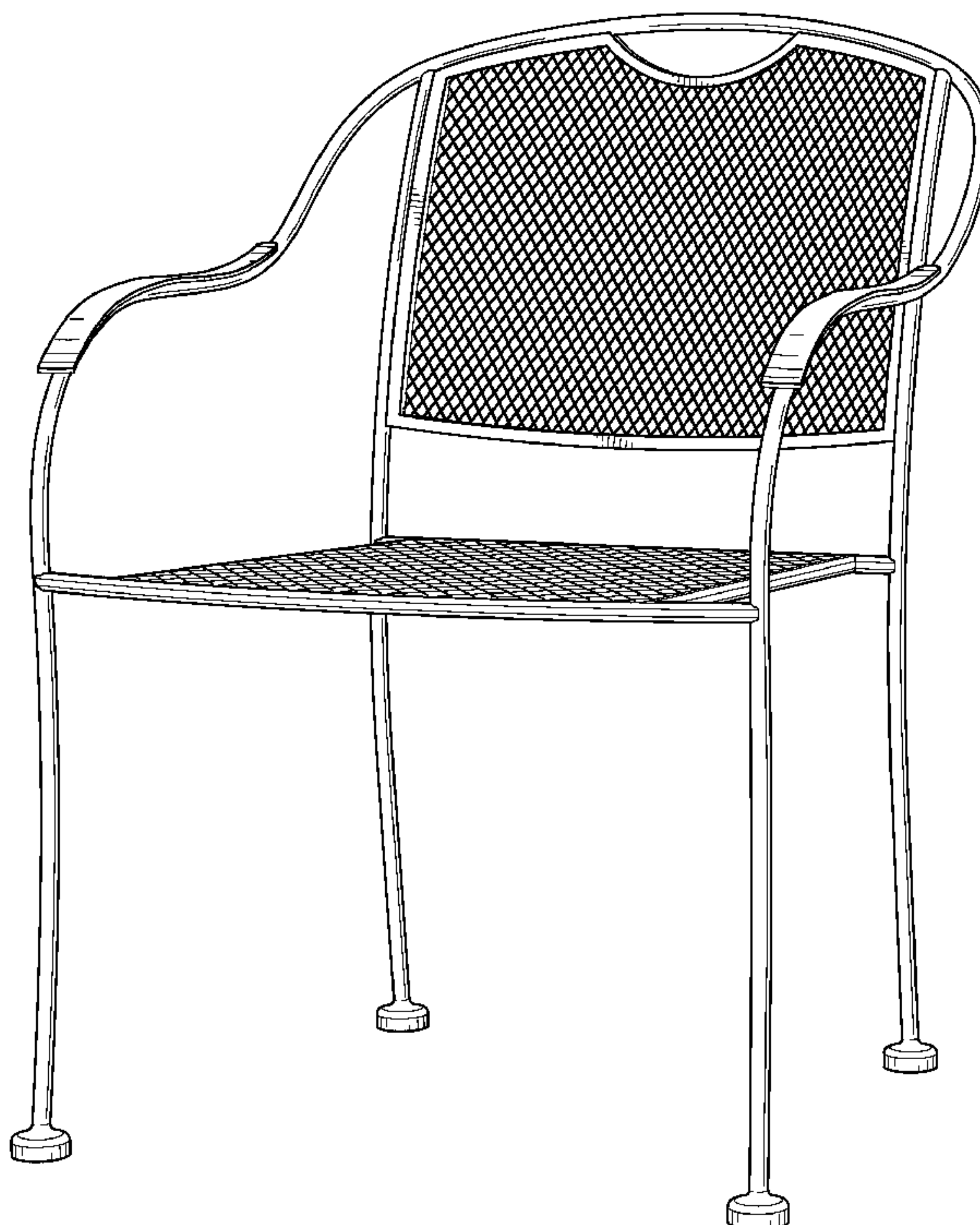

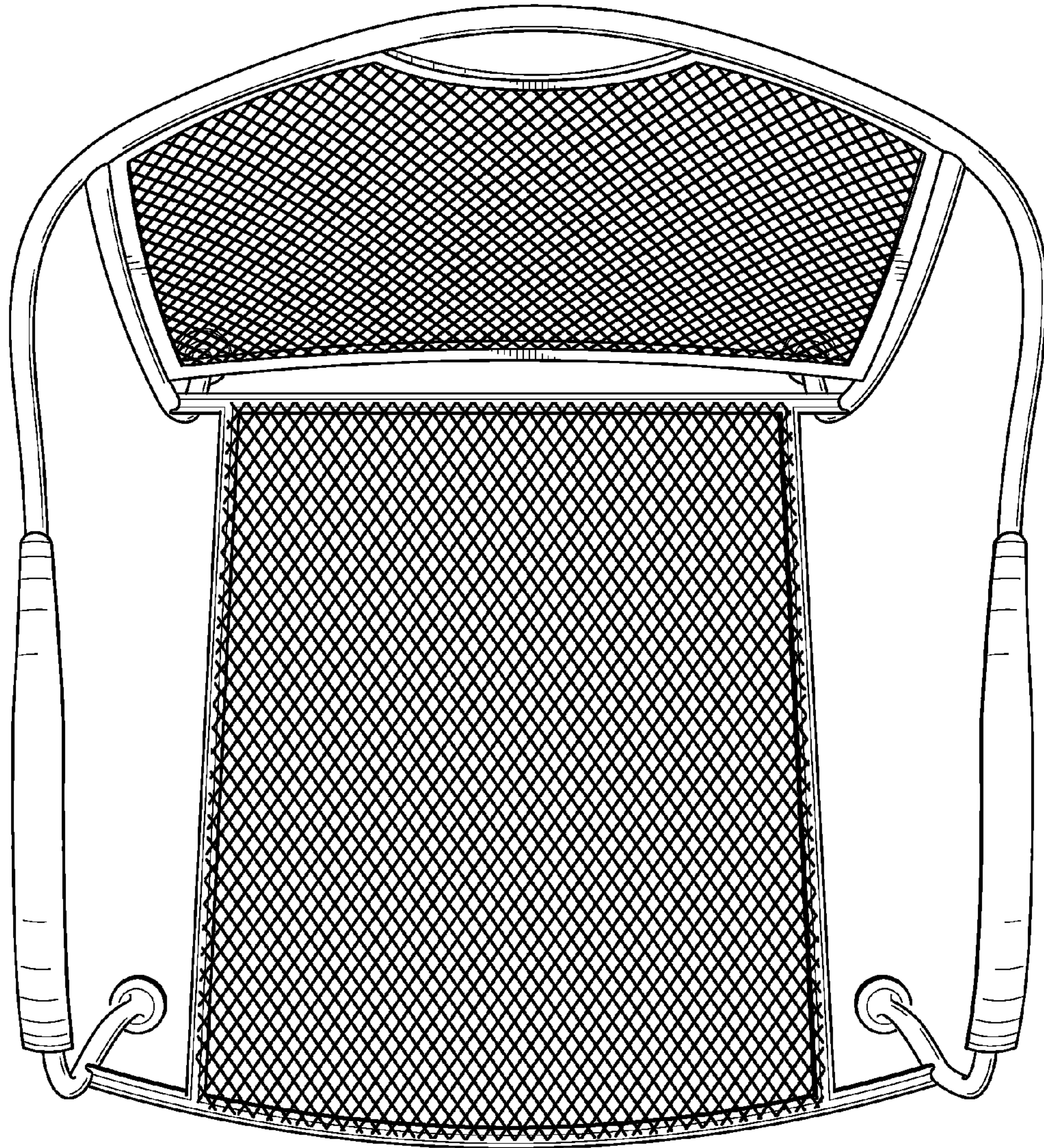

FIG. 1

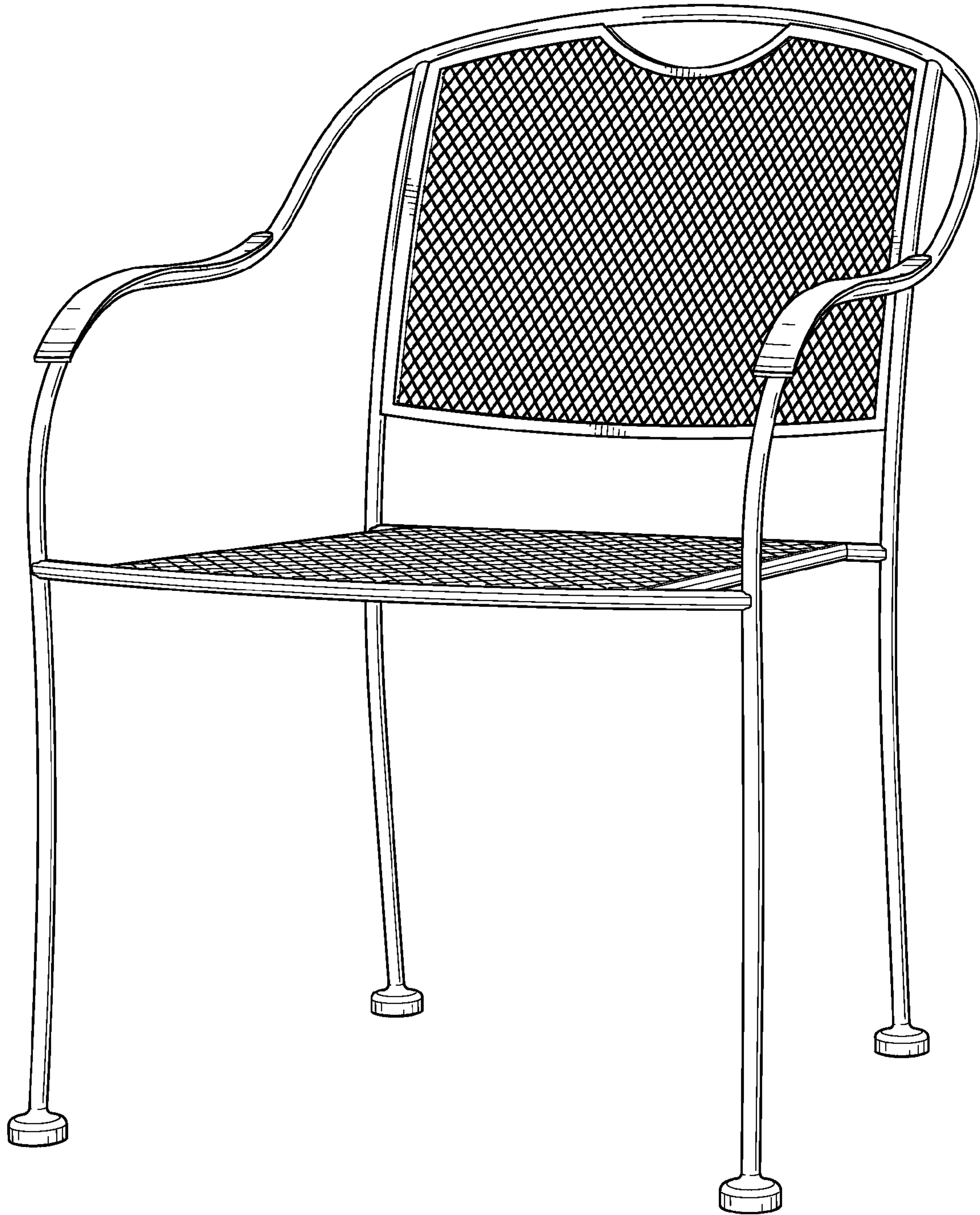

Fig. 2

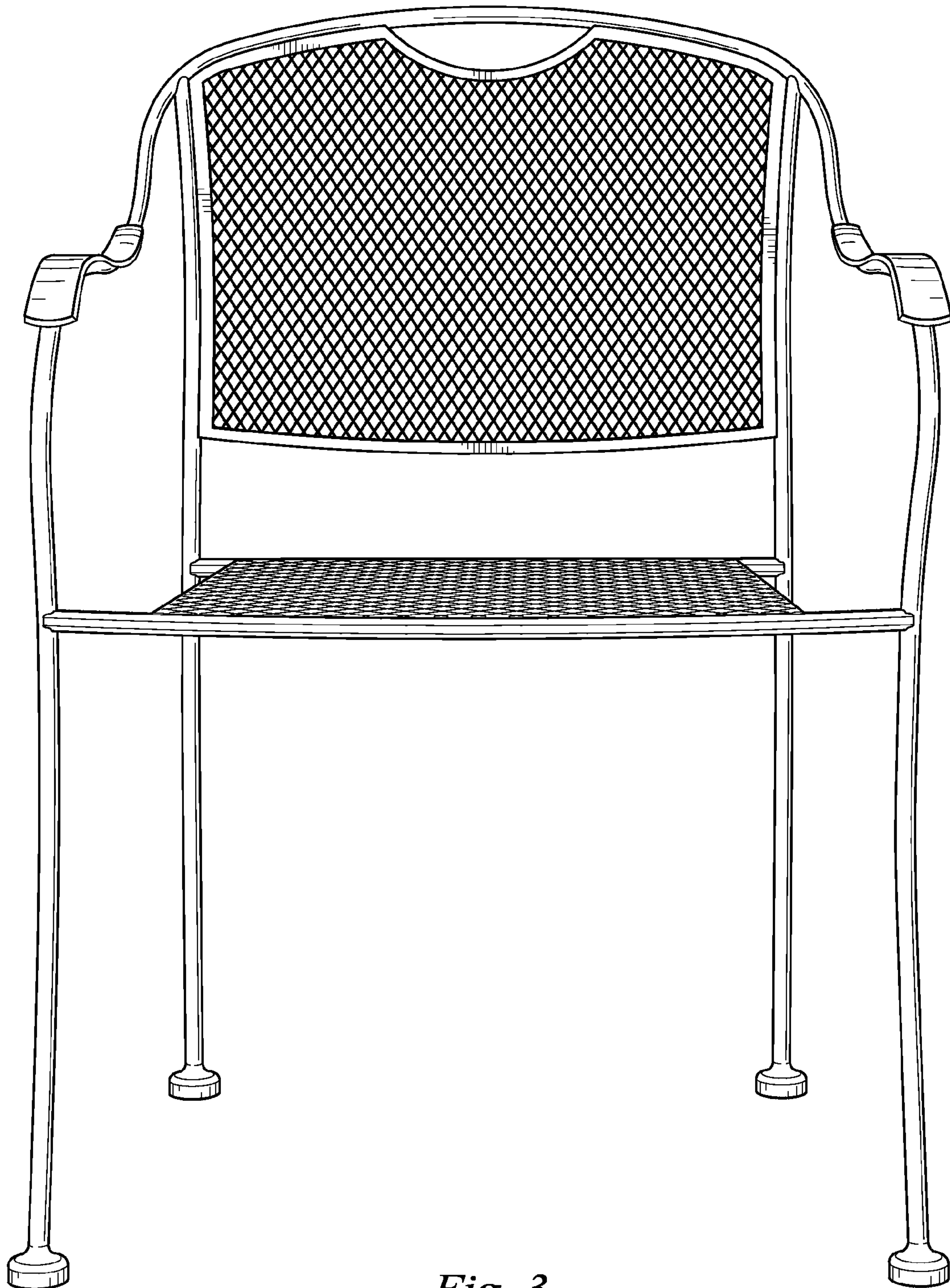

Fig. 3

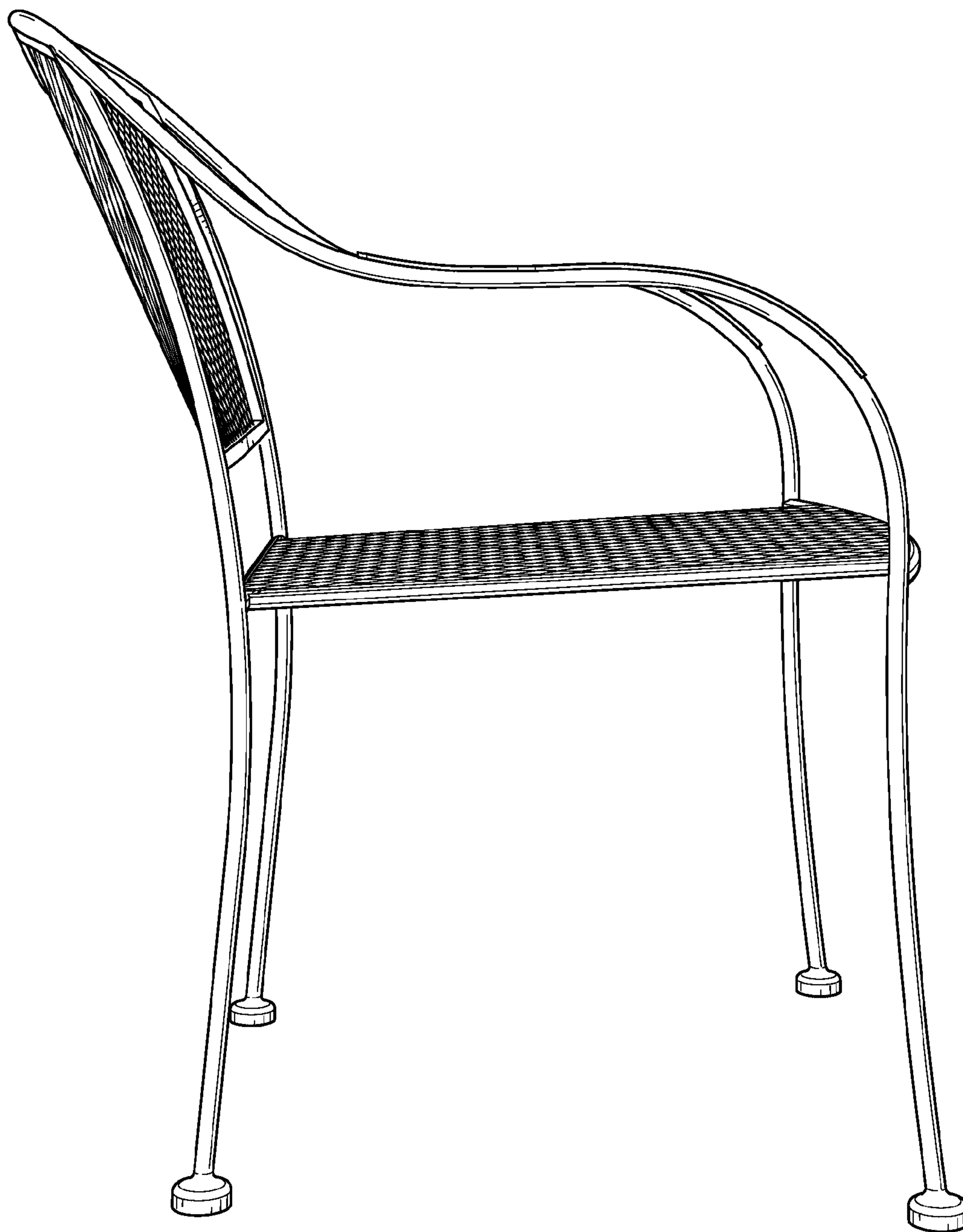

Fig. 4

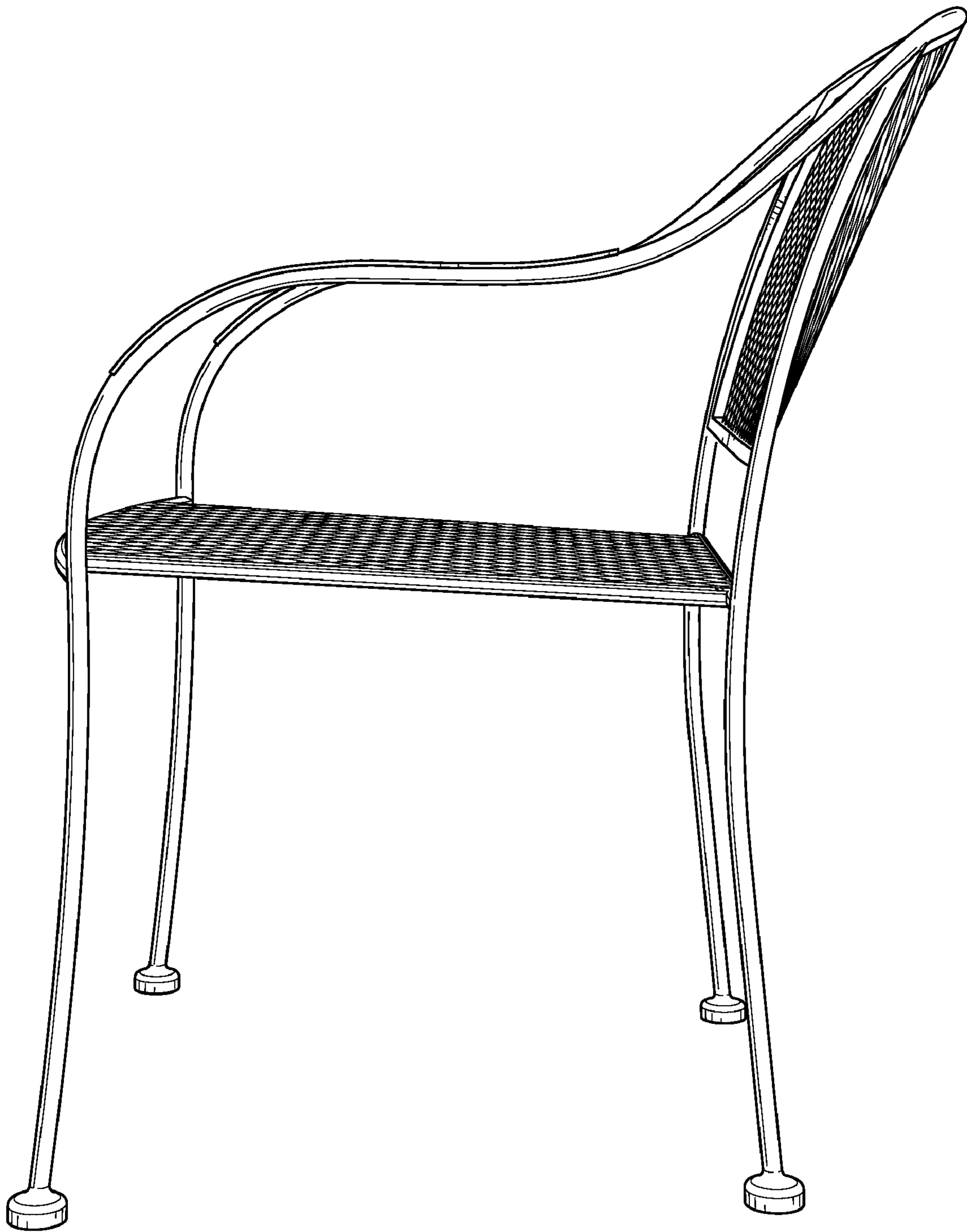

Fig. 5

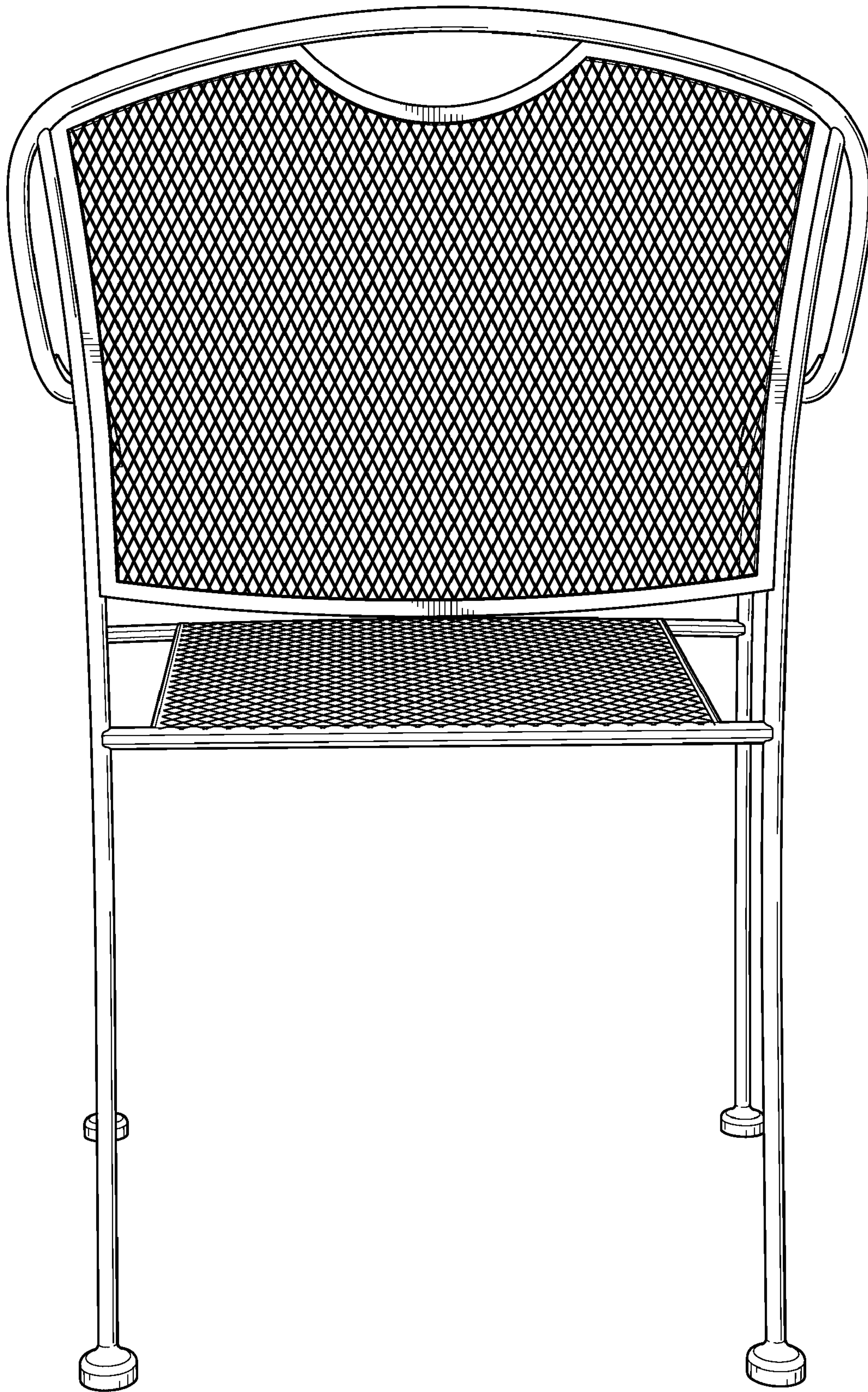

Fig. 6

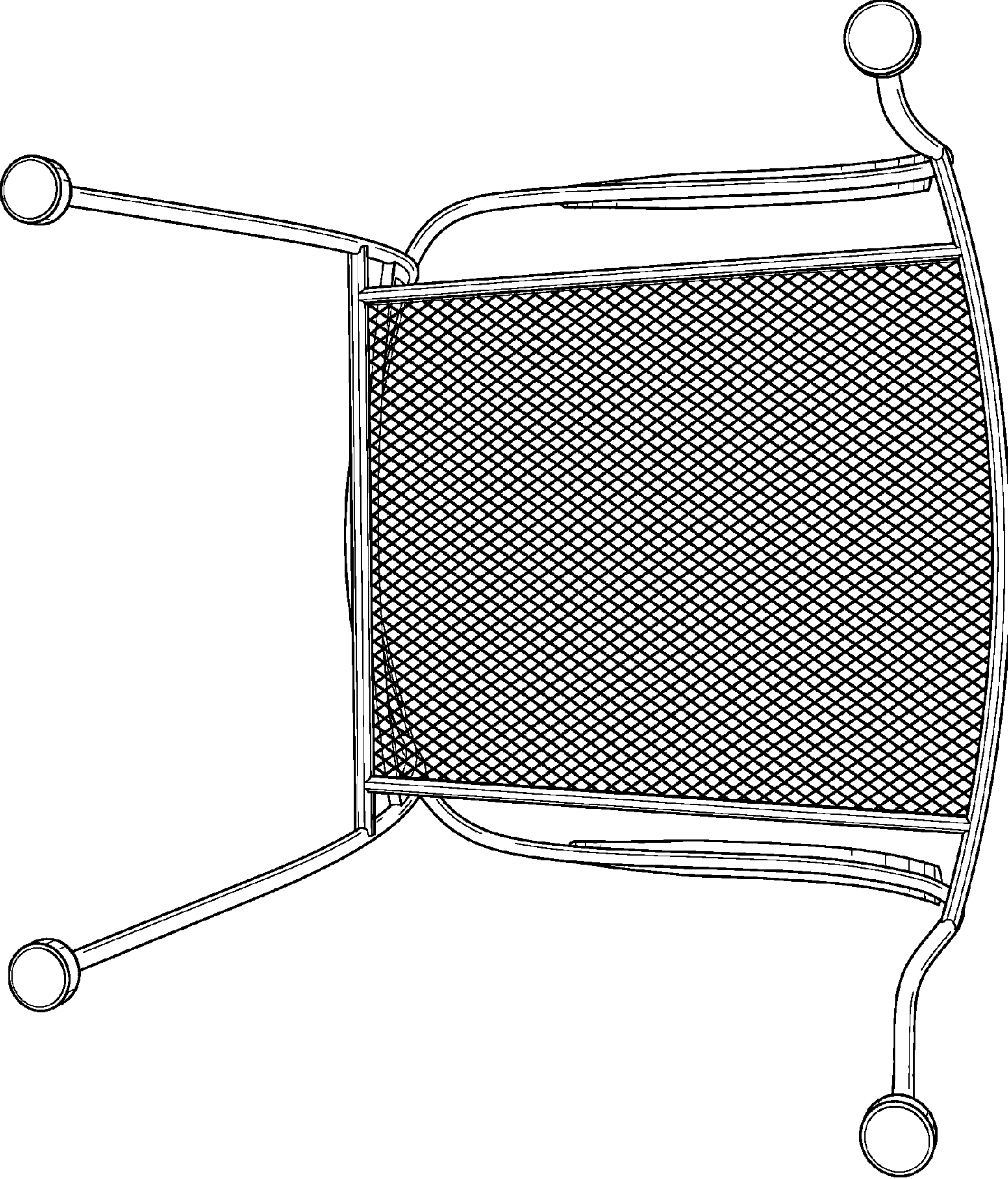

FIG. 7

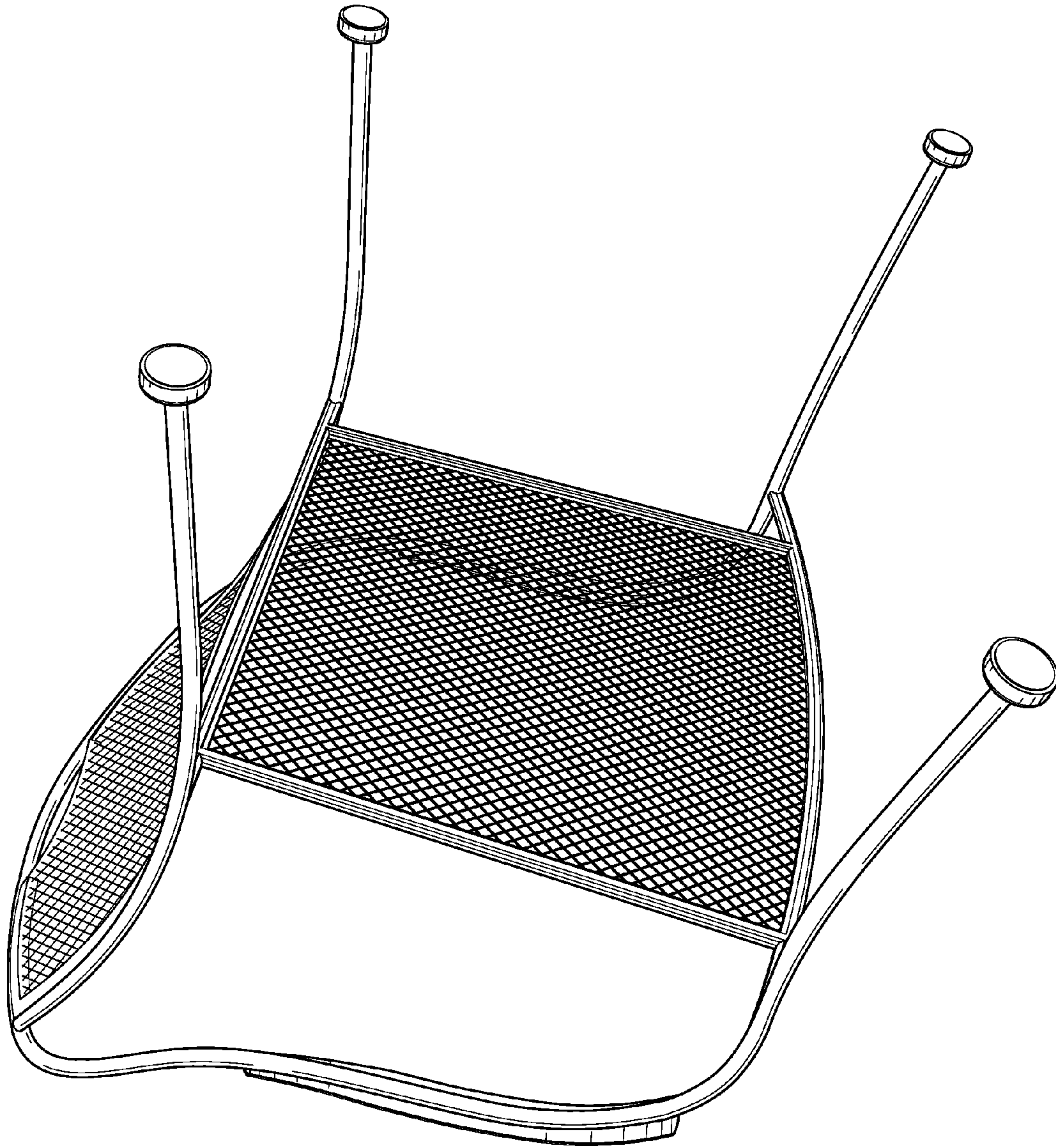

Fig. 8