

US00D594229S

(12) **United States Design Patent**
Barkdoll et al.

(10) **Patent No.:** **US D594,229 S**
(45) **Date of Patent:** **** Jun. 16, 2009**

(54) **BIN FOR OVER WIRE MOUNTING**

(75) Inventors: **Patrick J. Barkdoll**, Pecatonica, IL (US); **Thomas E. Valiulis**, Rockford, IL (US)

(73) Assignee: **Southern Imperial, Inc.**, Rockford, IL (US)

(**) Term: **14 Years**

(21) Appl. No.: **29/323,221**

(22) Filed: **Aug. 21, 2008**

(51) **LOC (9) Cl.** **03-01**

(52) **U.S. Cl.** **D3/304**

(58) **Field of Classification Search** D3/304-315;
D19/75, 78, 86, 90, 91, 99, 100; D6/566,
D6/567, 569, 512, 553; 211/10, 11, 13.1,
211/45, 50, 52, 55, 87.01, 90.03, 126.9, 126.13,
211/88.01; 220/456

See application file for complete search history.

(56) **References Cited**

U.S. PATENT DOCUMENTS

D281,477 S *	11/1985	Neff	D6/567
D356,461 S *	3/1995	May et al.	D6/567
5,727,696 A	3/1998	Valiulis		
5,738,260 A *	4/1998	Kirtland	224/515
D458,640 S *	6/2002	Hofman	D19/90
D475,411 S *	6/2003	Hardy et al.	D19/90
D486,022 S *	2/2004	Shamoon	D6/553
6,726,035 B2	4/2004	Zadak		
D538,529 S *	3/2007	Rosen et al.	D3/206
D548,282 S *	8/2007	Chen et al.	D19/90

OTHER PUBLICATIONS

U.S. Appl. No. 29/323,225, filed Aug. 21, 2008, Barkdoll et al.
U.S. Appl. No. 12/195,464, filed Aug. 21, 2008, Barkdoll et al.
Southern Imperial, Inc., Dump Bins RPDMP-127032 @ Southern Imperial, 2 pages, pages from a website, date last visited Jun. 17, 2008, http://shop.southernimperial.com/Dump_Bins_RPDMP-127032_P7765C77.cfm.

(Continued)

Primary Examiner—T. Chase Nelson
Assistant Examiner—Eric L Goodman
(74) *Attorney, Agent, or Firm*—Reinhart Boerner Van Deuren P.C.

(57) **CLAIM**

The ornamental design for a bin for over wire mounting, as shown and described.

DESCRIPTION

FIG. 1 is an isometric view of a first embodiment of a bin for over wire mounting showing our new design;

FIG. 2 is a top view of the bin shown in FIG. 1;

FIG. 3 is a front view of the bin shown in FIG. 1;

FIG. 4 is a right side view of the bin shown in FIG. 1;

FIG. 5 is a left side view of the bin shown in FIG. 1;

FIG. 6 is a back view of the bin shown in FIG. 1;

FIG. 7 is a bottom view of the bin shown in FIG. 1; and

FIG. 8 is an isometric view of second embodiment of a bin for over wire mounting, in which the design is the same as that of the first embodiment, excepting that in this embodiment the bin is shown to be opaque as opposed to translucent;

FIG. 9 is a top view of the bin shown in FIG. 8;

FIG. 10 is a front view of the bin shown in FIG. 8;

FIG. 11 is a right side view of the bin shown in FIG. 8;

FIG. 12 is a left side view of the bin shown in FIG. 8;

FIG. 13 is a back view of the bin shown in FIG. 8; and,

FIG. 14 is a bottom view of the bin shown in FIG. 8.

The broken line showing of openings formed in the bottom, and a partition wall divider is included for the purpose of illustrating portions of the article and forms no part of the claimed design. The broken line showing a potential operating environment of cross wires in FIG. 1 is included for the purpose of illustrating environmental structure and forms no part of the claimed design.

1 Claim, 8 Drawing Sheets

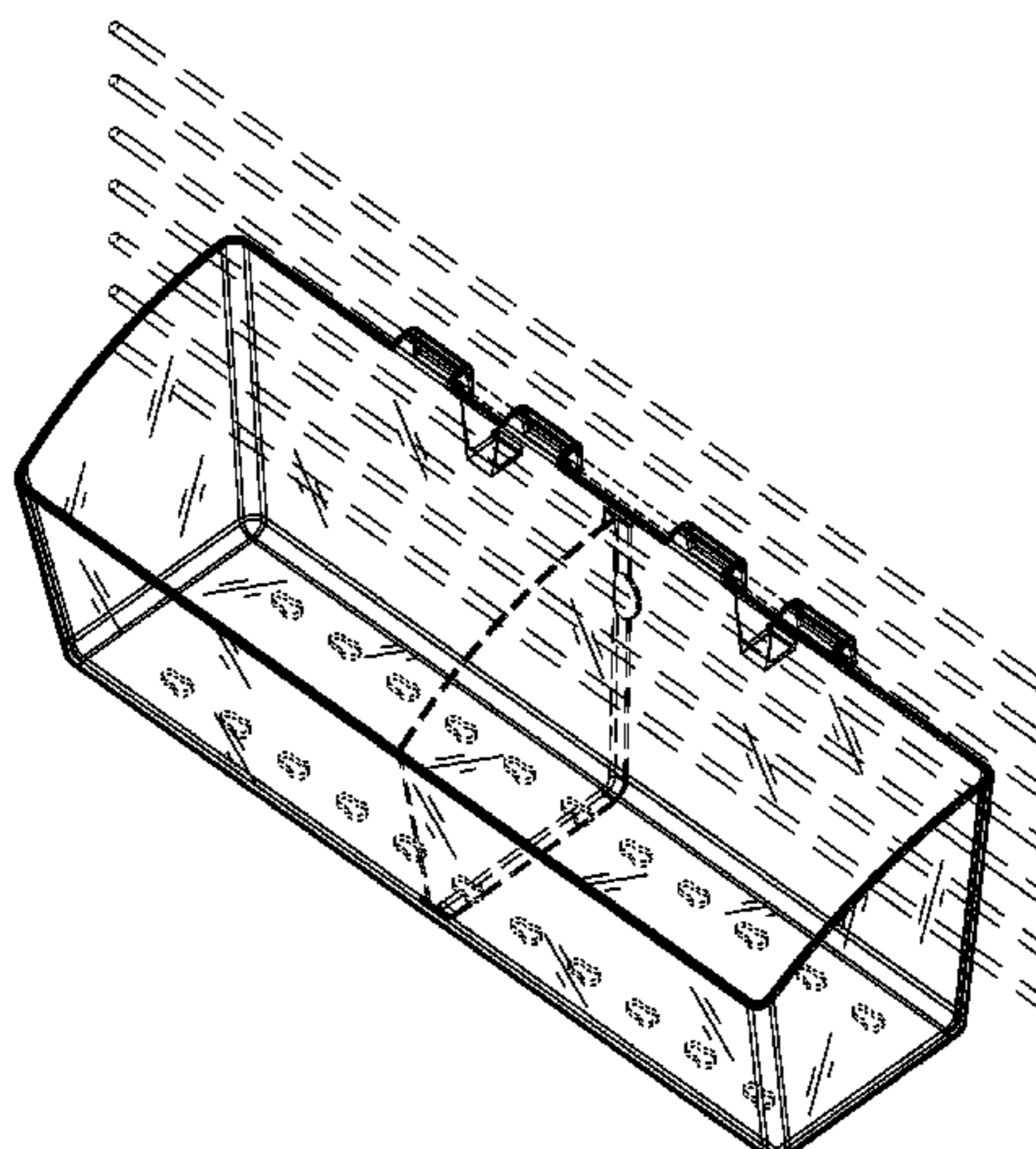

OTHER PUBLICATIONS

Southern Imperial, Inc., Dump Bins RPDMP-129555 @ Southern Imperial, 2 pages, pages from a website, date last visited Jun. 17, 2008, http://shop.southernimperial.com/Dump_Bins_RPDMP-129555_P7764C77.cfm.

Southern Imperial, Inc., Dump Bins RPDMP-65595 @ Southern Imperial, 2 pages, pages from a website, date last visited Jun. 17, 2008, http://shop.southernimperial.com/Dump_Bins_RPDMP-65595_P1934C77.cfm.

Southern Imperial, Inc., Baskets R40BSKE2410K @ Southern Imperial, 2 pages, pages from a website, date last visited Jun. 17, 2008, http://shop.southernimperial.com/Baskets_R40BSKE2410K_P1345C69.cfm.

Southern Imperial, Inc., Baskets R40-1728-A @ Southern Imperial, 2 pages, pages from a website, date last visited Jun. 17, 2008, http://shop.southernimperial.com/Baskets_R40-1728-A_P1343C69.cfm.

Southern Imperial, Inc., Wire Endcap Fastracks Displays R40-III-1BX @ Southern Imperial, 2 pages, pages from a website, date last

visited Jun. 17, 2008, http://shop.southernimperial.com/Wire_Endcap_Fastracks_Displays_P1632C70.cfm.

Southern Imperial, Inc., Endless Baskets R-9023045 @ Southern Imperial, 2 pages, pages printed from a website, date last visited Jun. 17, 2008, http://shop.southernimperial.com/Endless_Baskets_R-9023045_P1445C76.cfm.

Southern Imperial, Inc., Wire Endcap Fastracks Displays R40-Baskets @ Southern Imperial, 2 pages, pages printed from a website, date last visited Jun. 17, 2008, http://shopsouthernimperial.com/Wire_Endcap_Fastracks_Displays_P1614C70.cfm.

Southern Imperial, Inc., Wire Endcap Fastracks Displays R40-SHELF @ Southern Imperial, 2 pages, pages printed from a website, date last visited Jun. 17, 2008, http://shop.southernimperial.com/Wire_Endcap_Fastracks_Displays_P1623C70.cfm.

Southern Imperial, Inc., Wire Endcap Fastracks Displays R40-HC @ Southern Imperial, 2 pages, pages printed from a website, date last visited Jun. 17, 2008. http://shop/southernimperial.com/Wire_Endcap_Fastracks_Displays_P1645C70.cfm.

* cited by examiner

FIG. 1

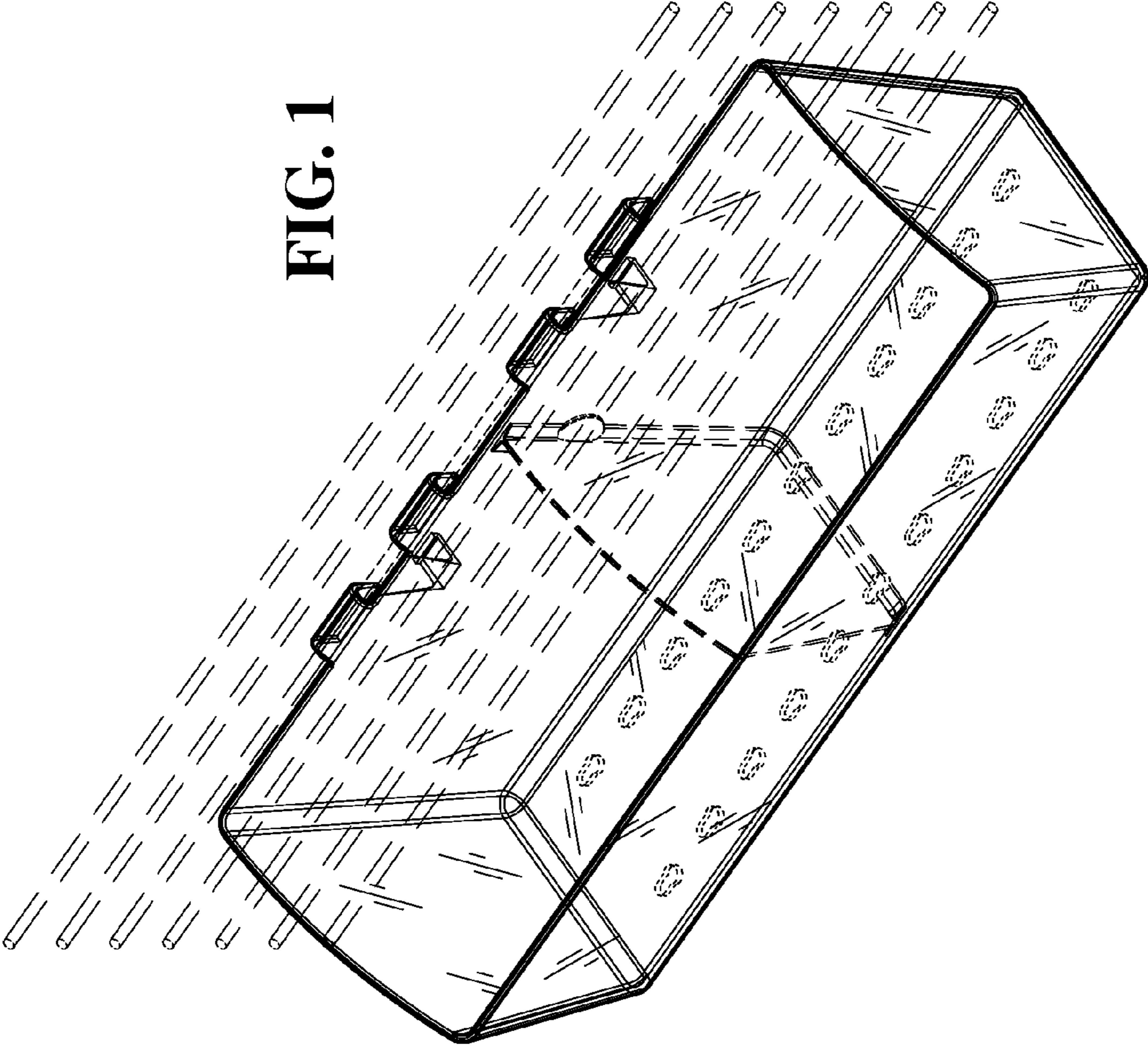

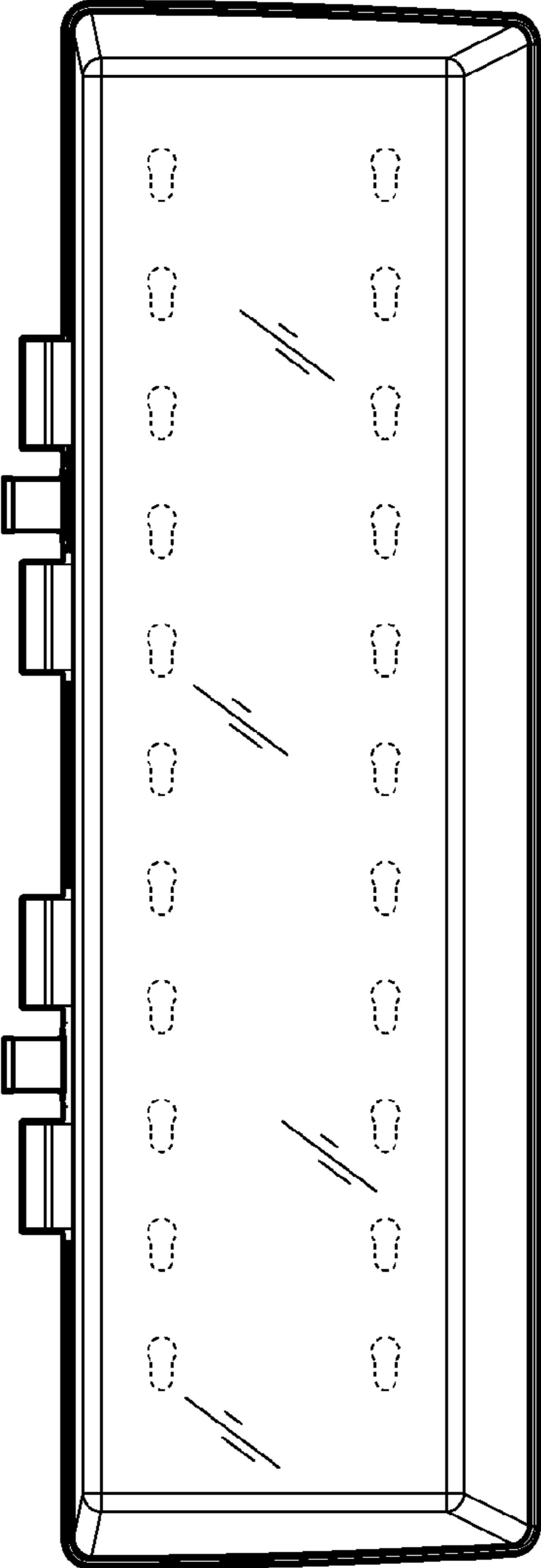

FIG. 2

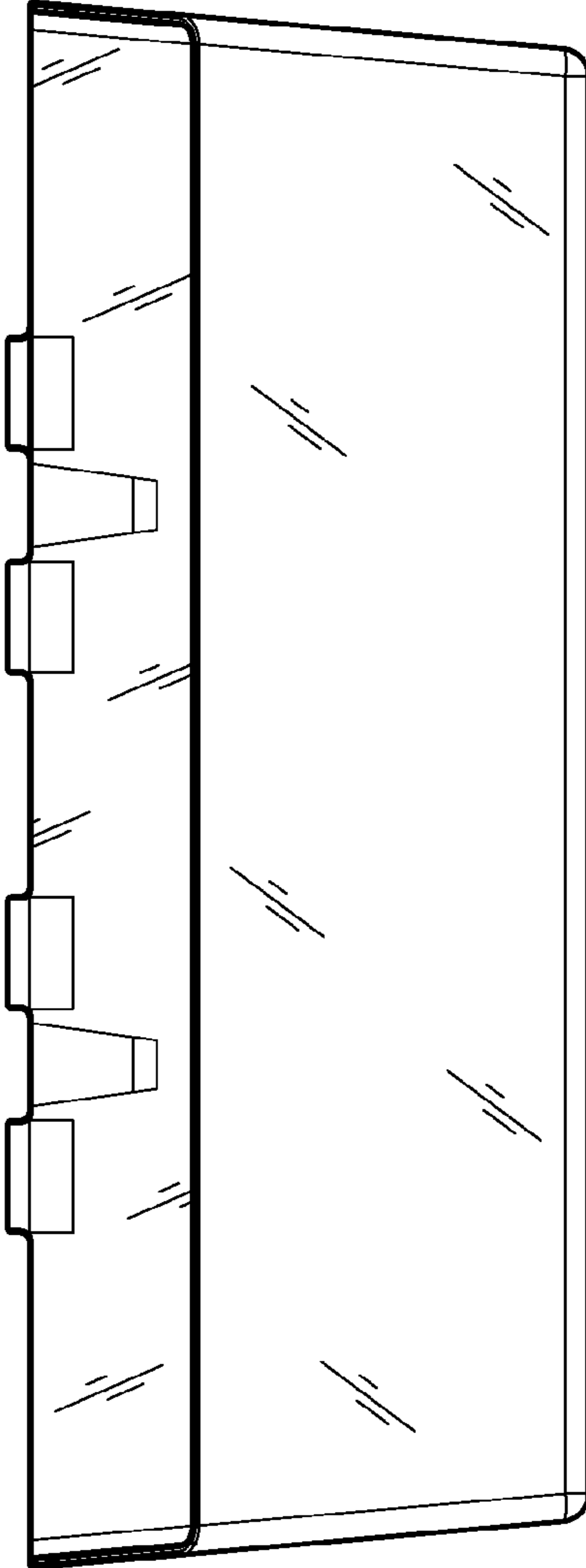

FIG. 3

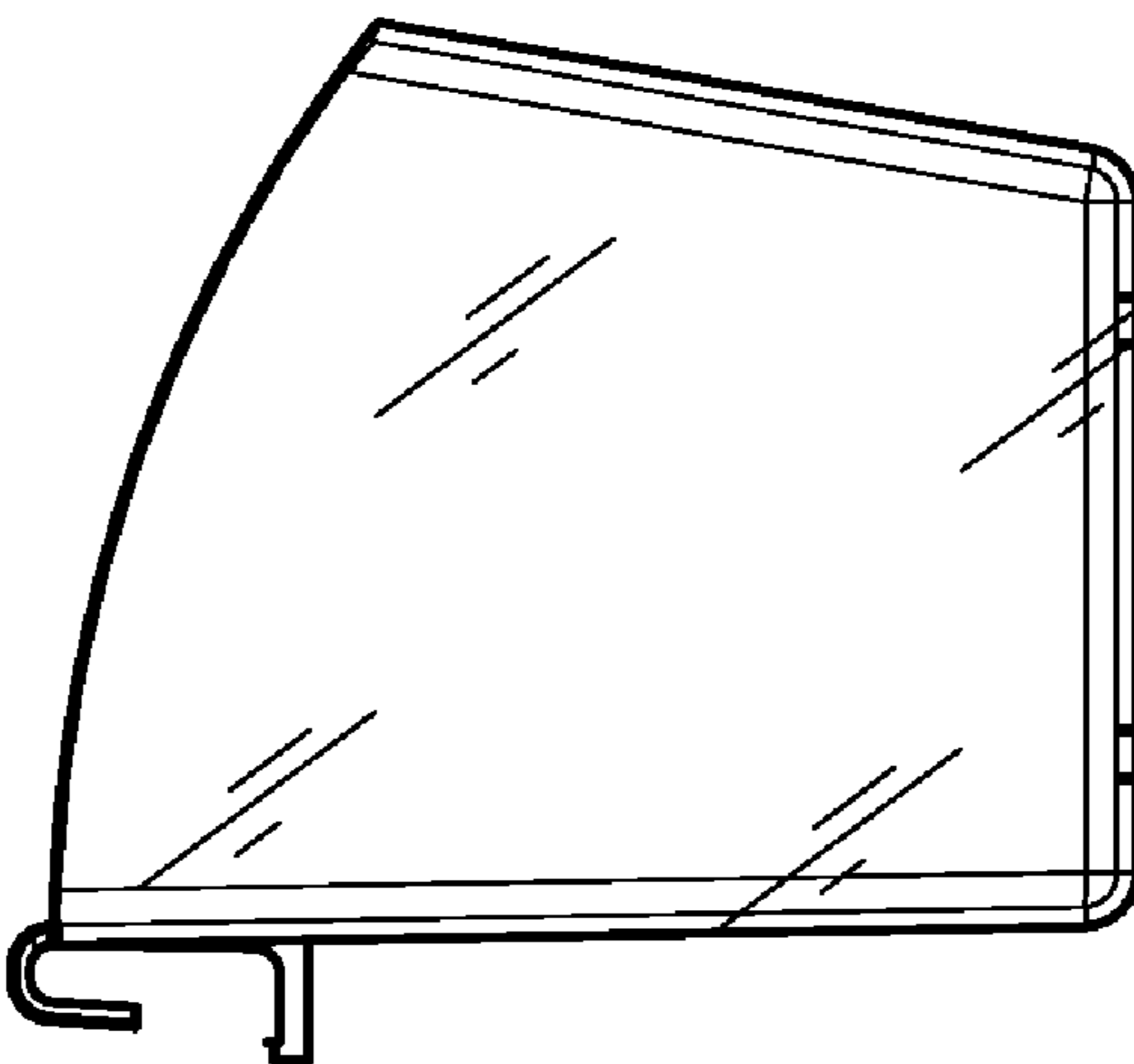

FIG. 5

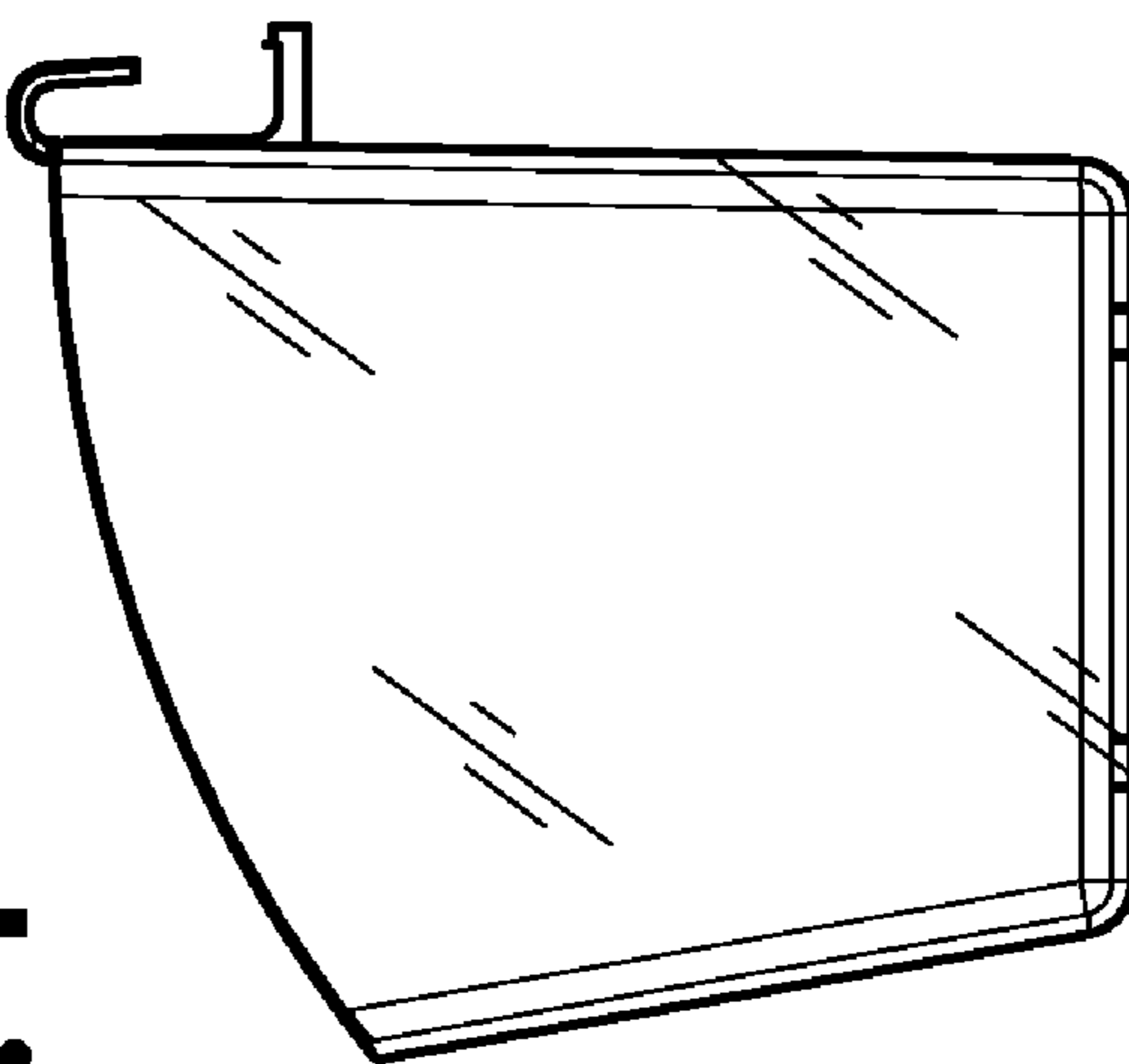

FIG. 4

FIG. 6

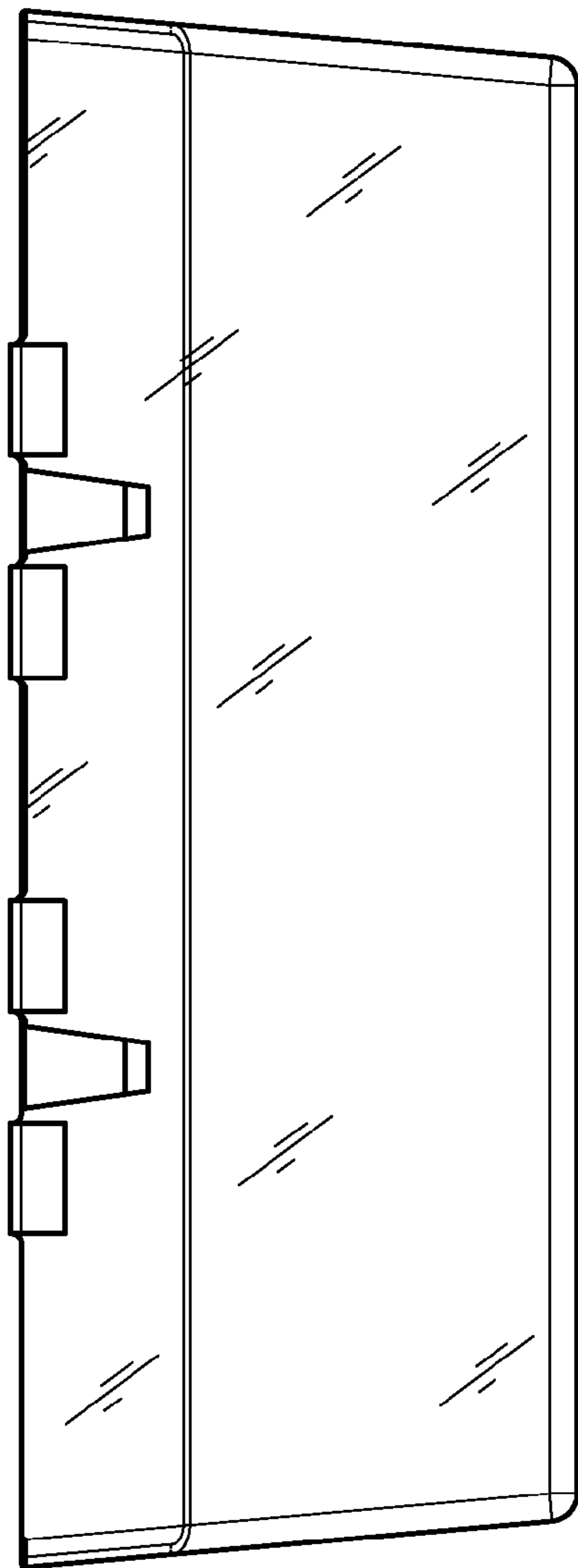

FIG. 7

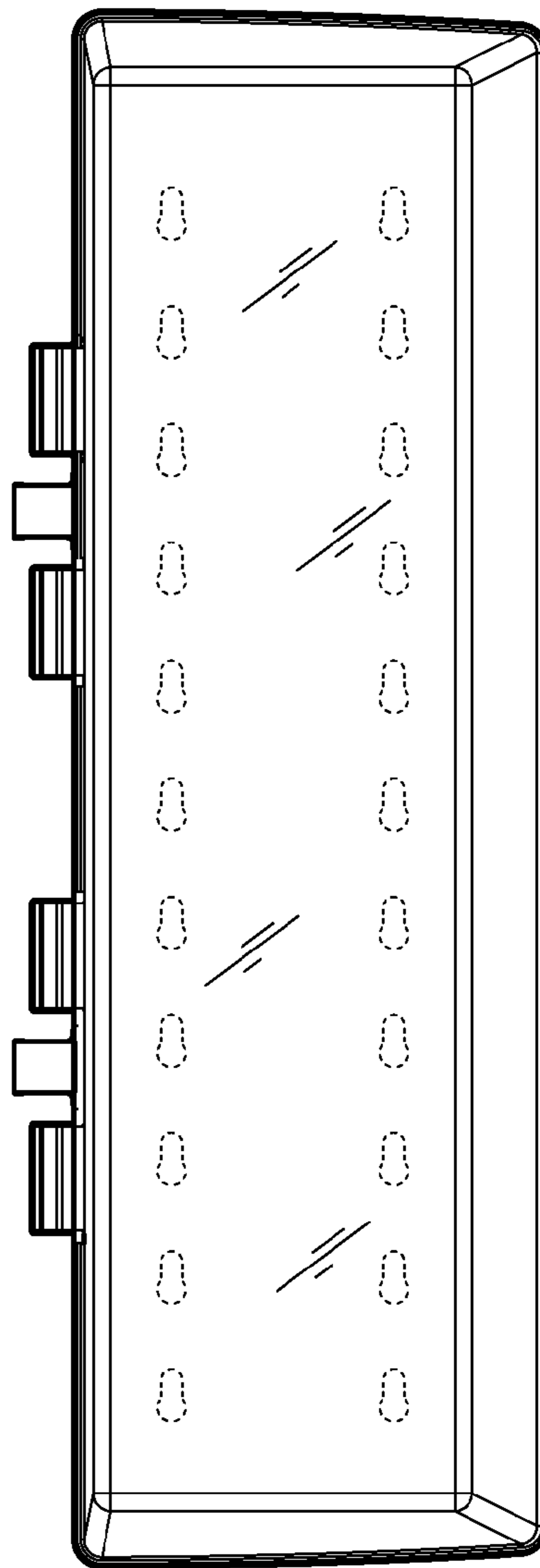
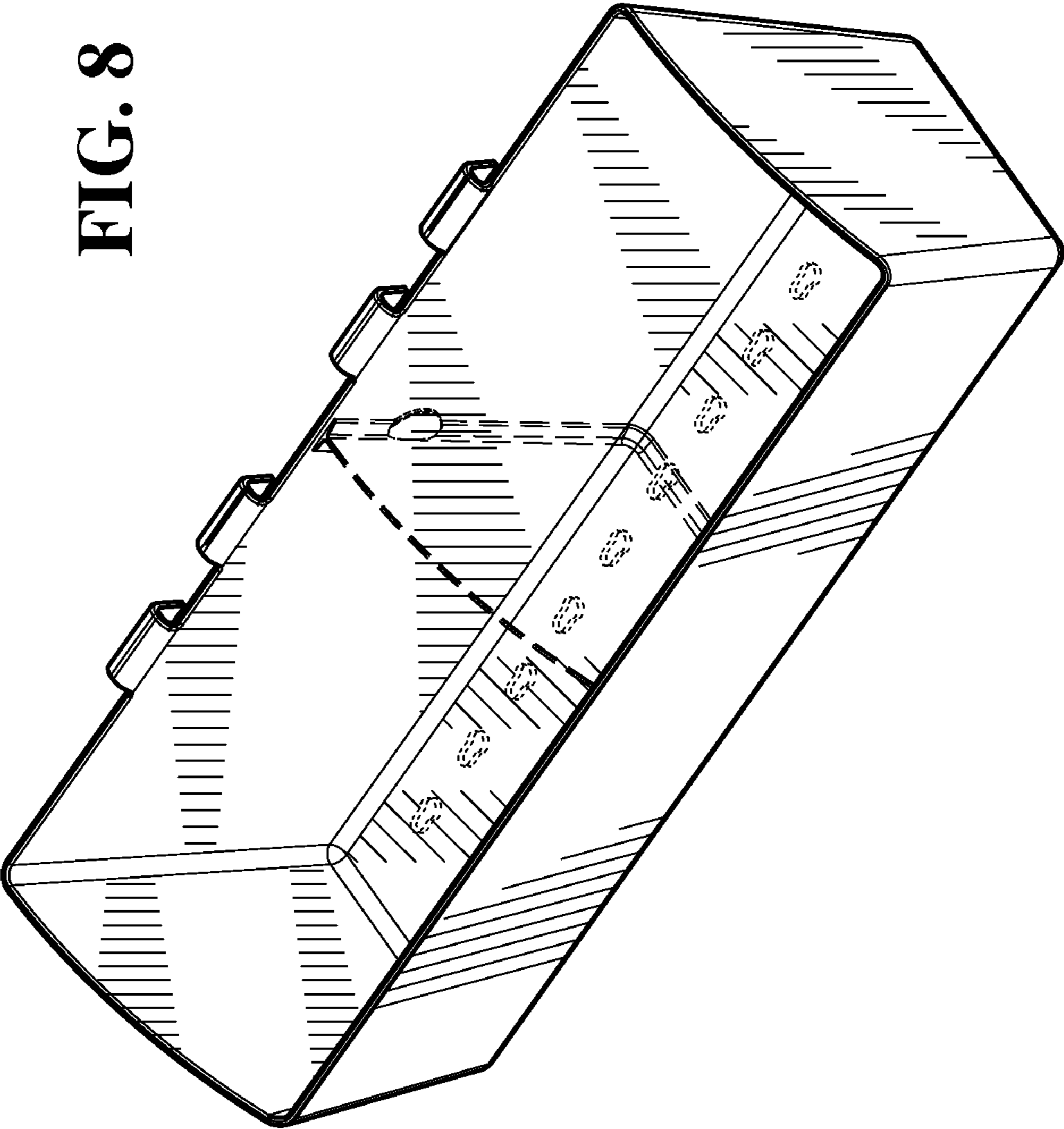

FIG. 8



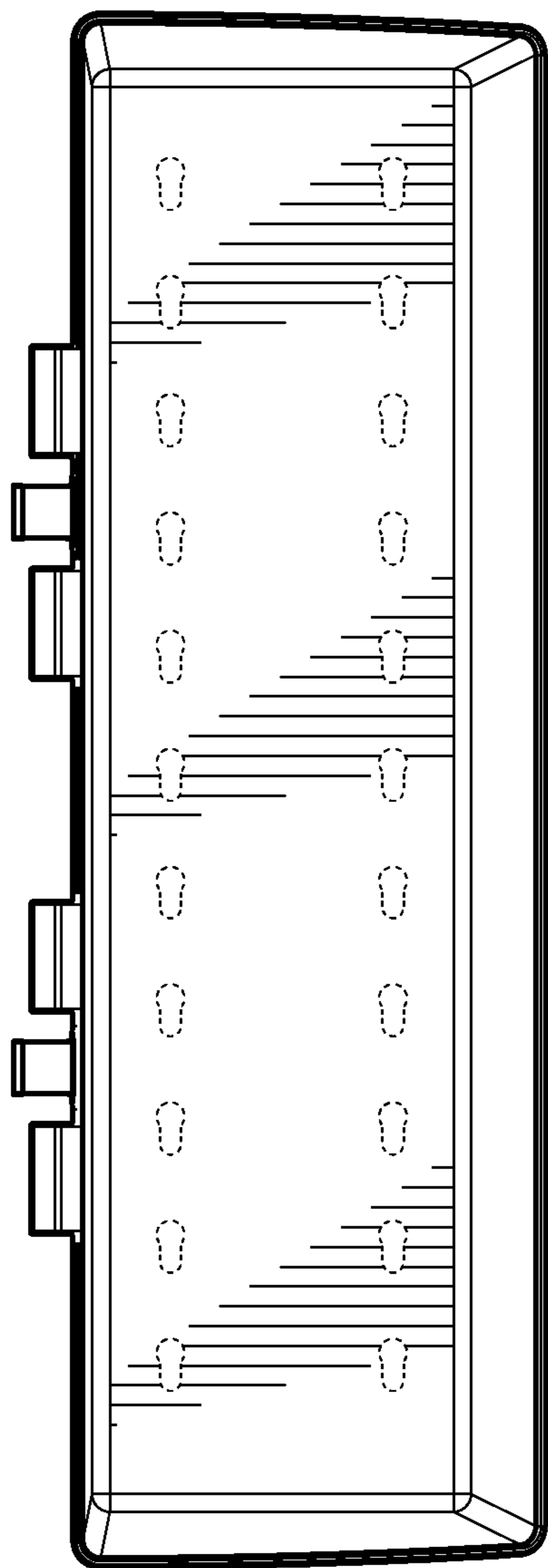

FIG. 9

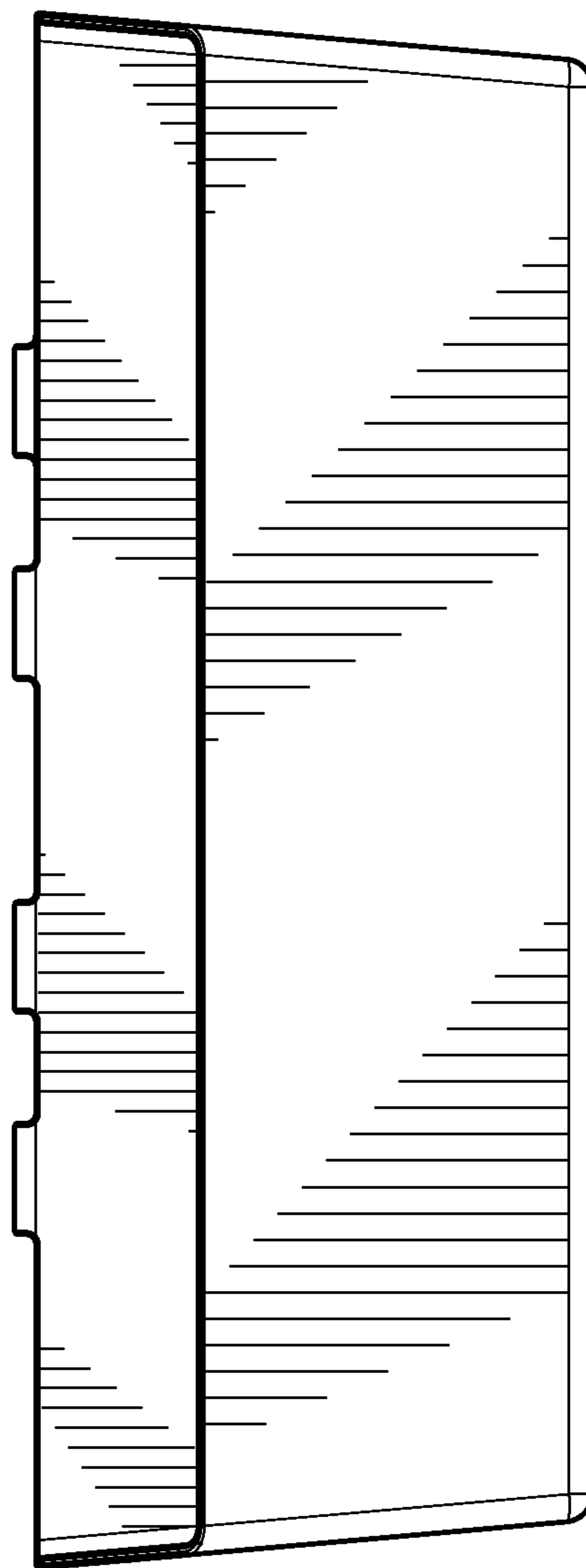

FIG. 10

FIG. 12

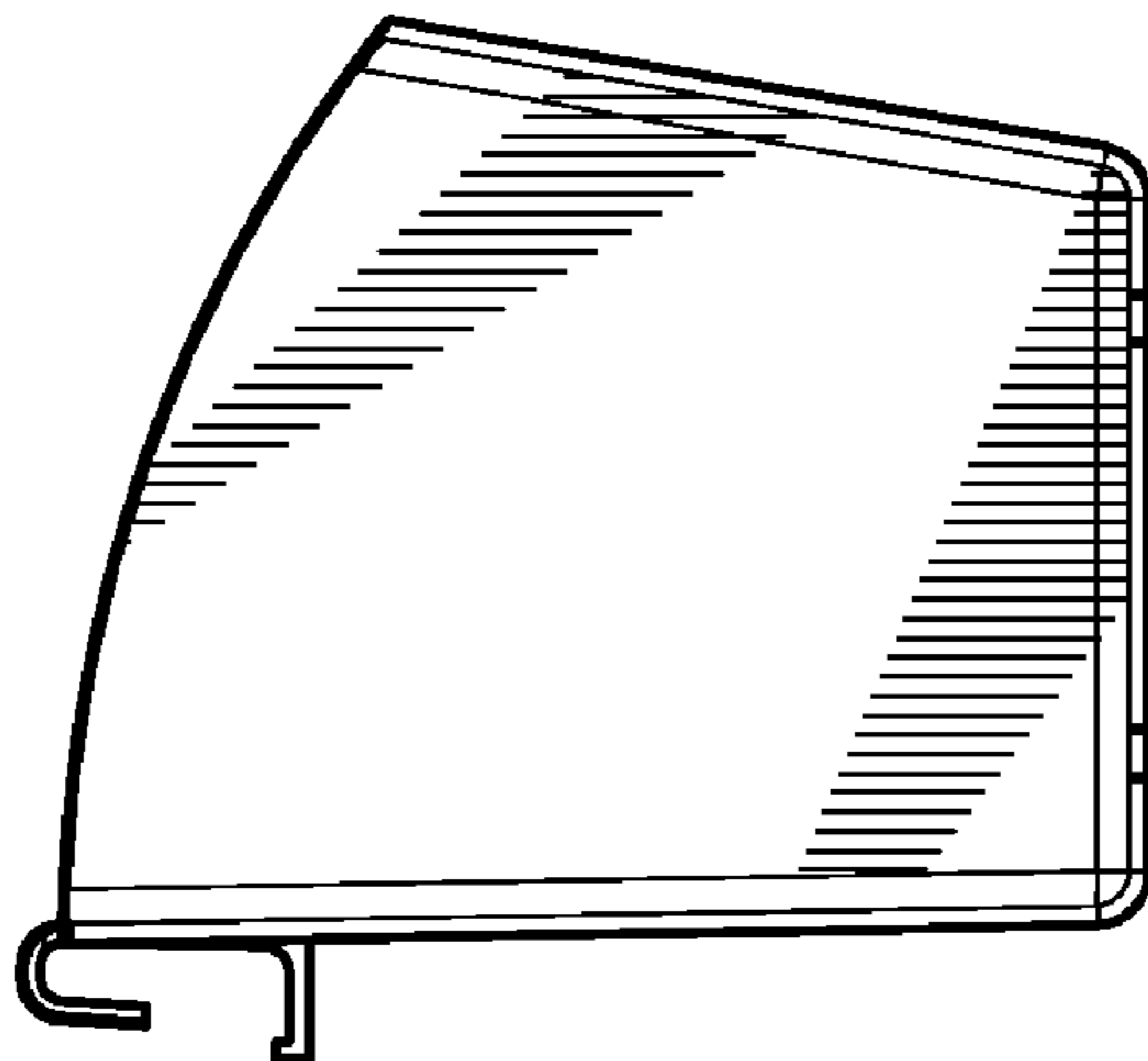

FIG. 11

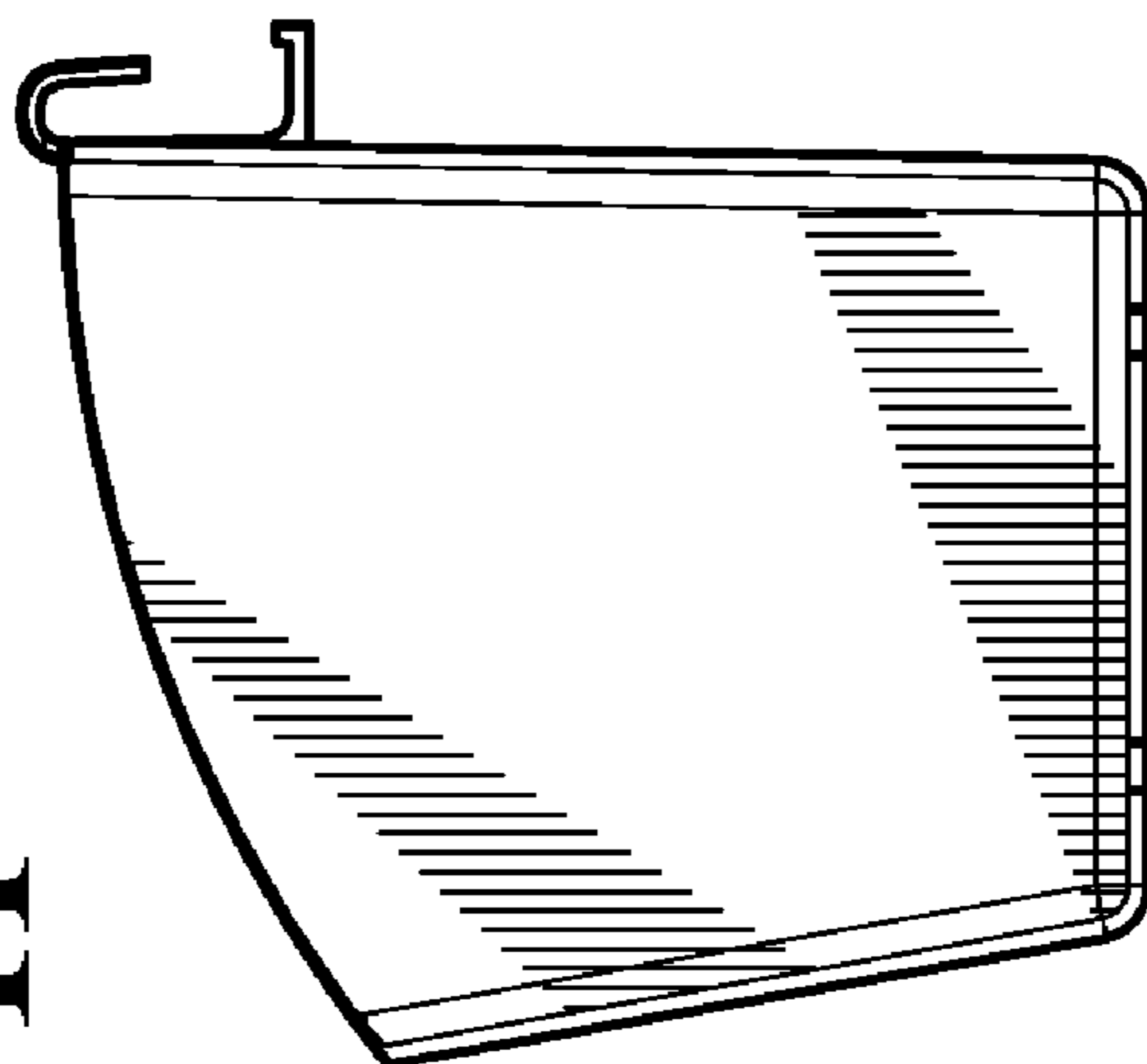

FIG. 13

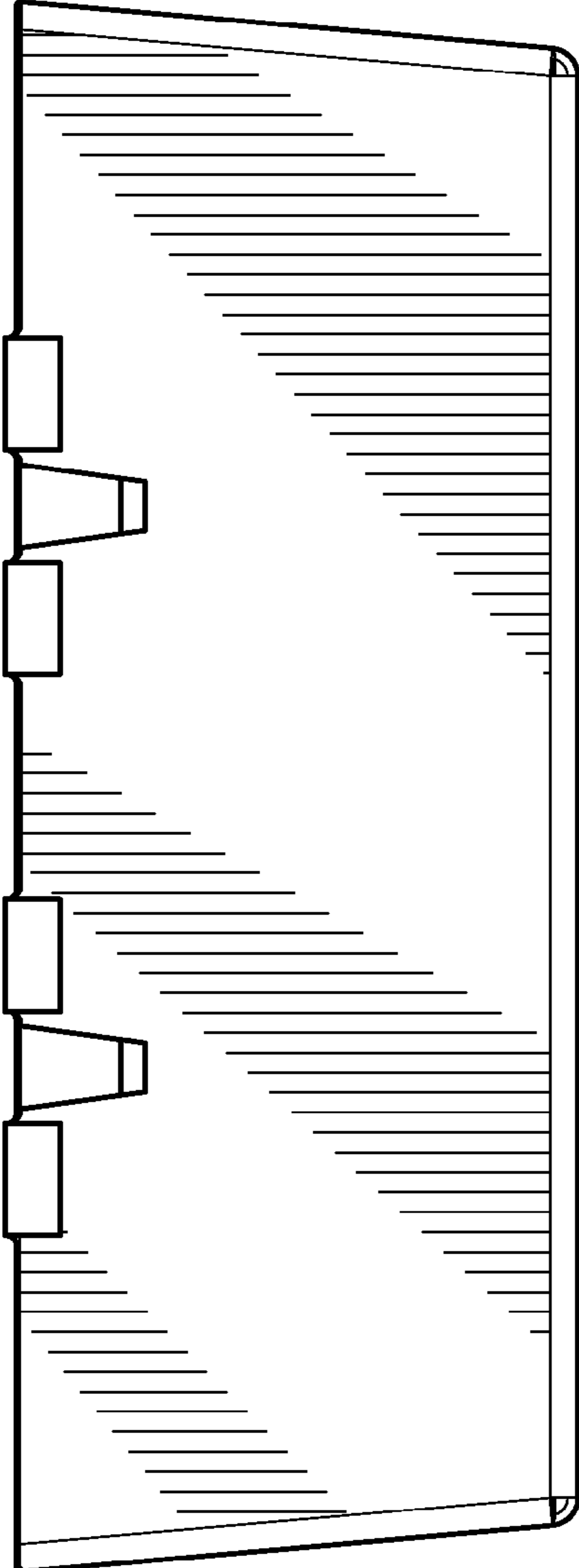

FIG. 14

