



US00D594223S

(12) **United States Design Patent**  
**Jackson**

(10) **Patent No.:** **US D594,223 S**  
(45) **Date of Patent:** **\*\* Jun. 16, 2009**

(54) **COMBINED SHOULDER HOLSTER AND INTERCHANGEABLE ATTACHMENT**

(76) Inventor: **Calvin Jackson**, 1506 St. Charles Rd., Maywood, IL (US) 60153

(\*\*) Term: **14 Years**

(21) Appl. No.: **29/285,694**

(22) Filed: **Apr. 6, 2007**

(51) **LOC (9) Cl.** ..... **03-01**

(52) **U.S. Cl.** ..... **D3/215**

(58) **Field of Classification Search** ..... D3/215,  
D3/218, 222-223; 224/192-193, 198, 245,  
224/911; D2/627

See application file for complete search history.

(56) **References Cited**

**U.S. PATENT DOCUMENTS**

D411,916 S *	7/1999	Jackson	.....	D3/218
6,016,797 A *	1/2000	Nowicke, Jr.	.....	126/25 R
D449,745 S *	10/2001	Slear	.....	D6/370
D467,417 S *	12/2002	Jackson	.....	D3/218
6,543,661 B1 *	4/2003	Lazur	.....	224/604
D547,942 S *	8/2007	Lavine	.....	D3/218
D561,464 S *	2/2008	Courtney	.....	D3/218
2002/0130150 A1 *	9/2002	Stanley	.....	224/600

\* cited by examiner

*Primary Examiner*—T. Chase Nelson

*Assistant Examiner*—Kathleen M Sims

(74) *Attorney, Agent, or Firm*—Husch Blackwell Sanders Welsh & Katz

(57) **CLAIM**

The ornamental design for a combined shoulder holster and interchangeable attachment, as shown and described.

**DESCRIPTION**

FIG. 1 is a front perspective view of a combined shoulder holster and interchangeable attachment with both attachments, showing my new design;

FIG. 2 is a rear perspective view thereof;

FIG. 3 is a top view thereof;

FIG. 4 is a front elevational view thereof;

FIG. 5 is a right side elevational view thereof;

FIG. 6 is a bottom view thereof;

FIG. 7 is a rear elevational view thereof;

FIG. 8 is a rear perspective view of a first attachment removed for ease of illustration and enlarged for clarity;

FIG. 9 is a front perspective view thereof;

FIG. 10 is a top view thereof;

FIG. 11 is a front elevational view thereof;

FIG. 12 is a right side elevational view thereof;

FIG. 13 is a rear elevational view thereof;

FIG. 14 is a left side elevational view thereof;

FIG. 15 is a bottom view thereof;

FIG. 16 is a front perspective view of a second attachment removed for ease of illustration and enlarged for clarity;

FIG. 17 is a rear perspective view thereof;

FIG. 18 is a top view thereof;

FIG. 19 is a front elevational view thereof;

FIG. 20 is a left side elevational view thereof;

FIG. 21 is a rear elevational view thereof;

FIG. 22 is a right side elevational view thereof; and,

FIG. 23 is a bottom view thereof.

The dashed lines shown in FIGS. 8-9, 11, 13, 16-17, 19, and 21 represent conventional stitching. The broken line showing of a shirt in FIGS. 1 and 2 is included for the purpose of showing the environment of the combined shoulder holster and interchangeable attachment and forms no part of the claimed design.

**1 Claim, 11 Drawing Sheets**

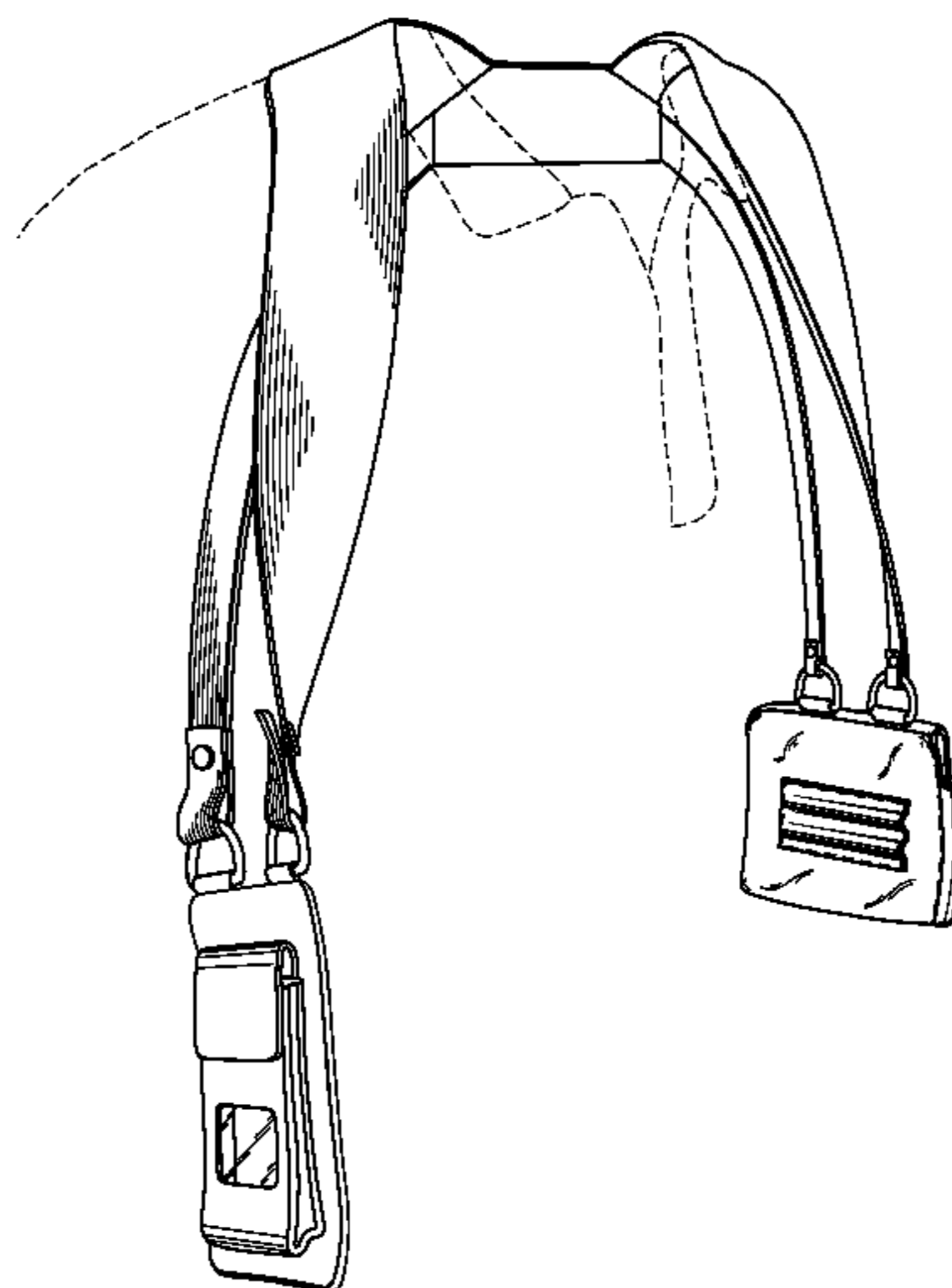

Fig. 1

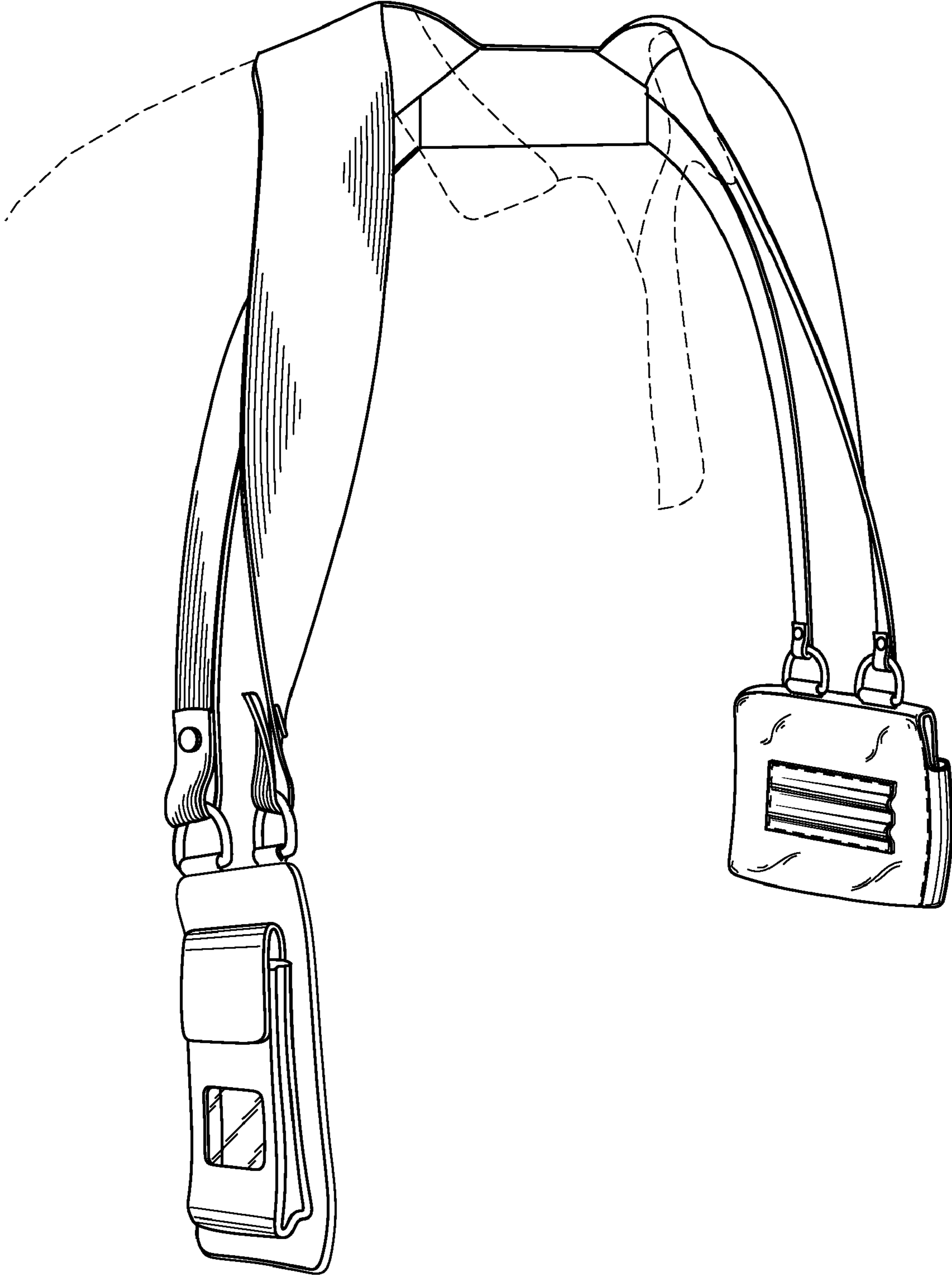

Fig. 2

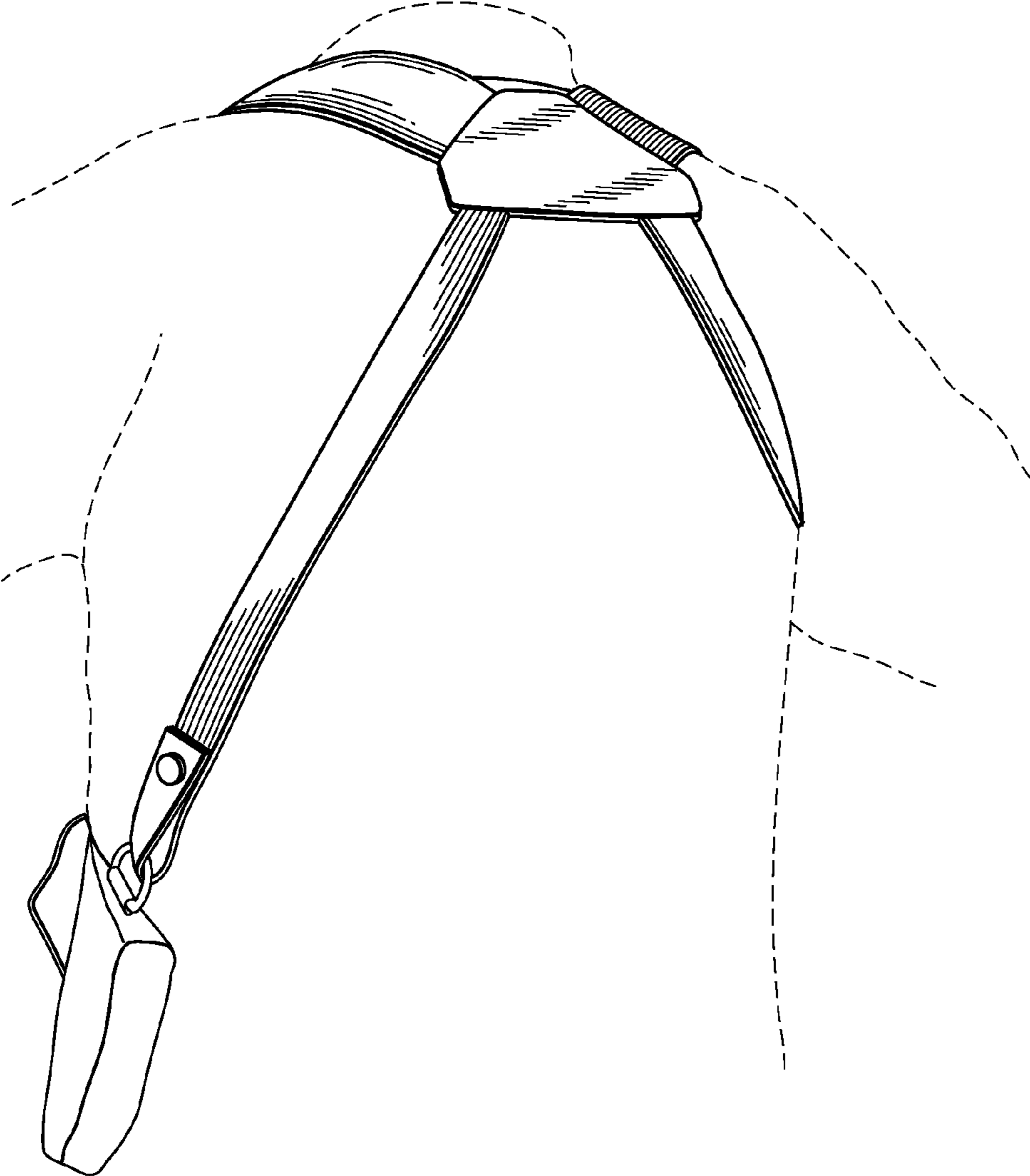

Fig. 3

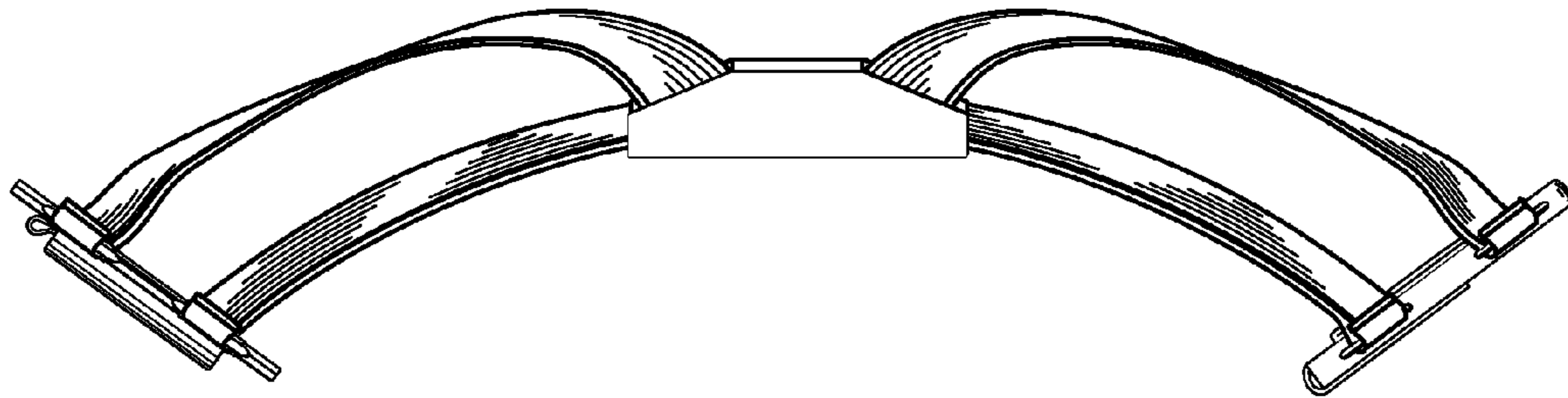

Fig. 4

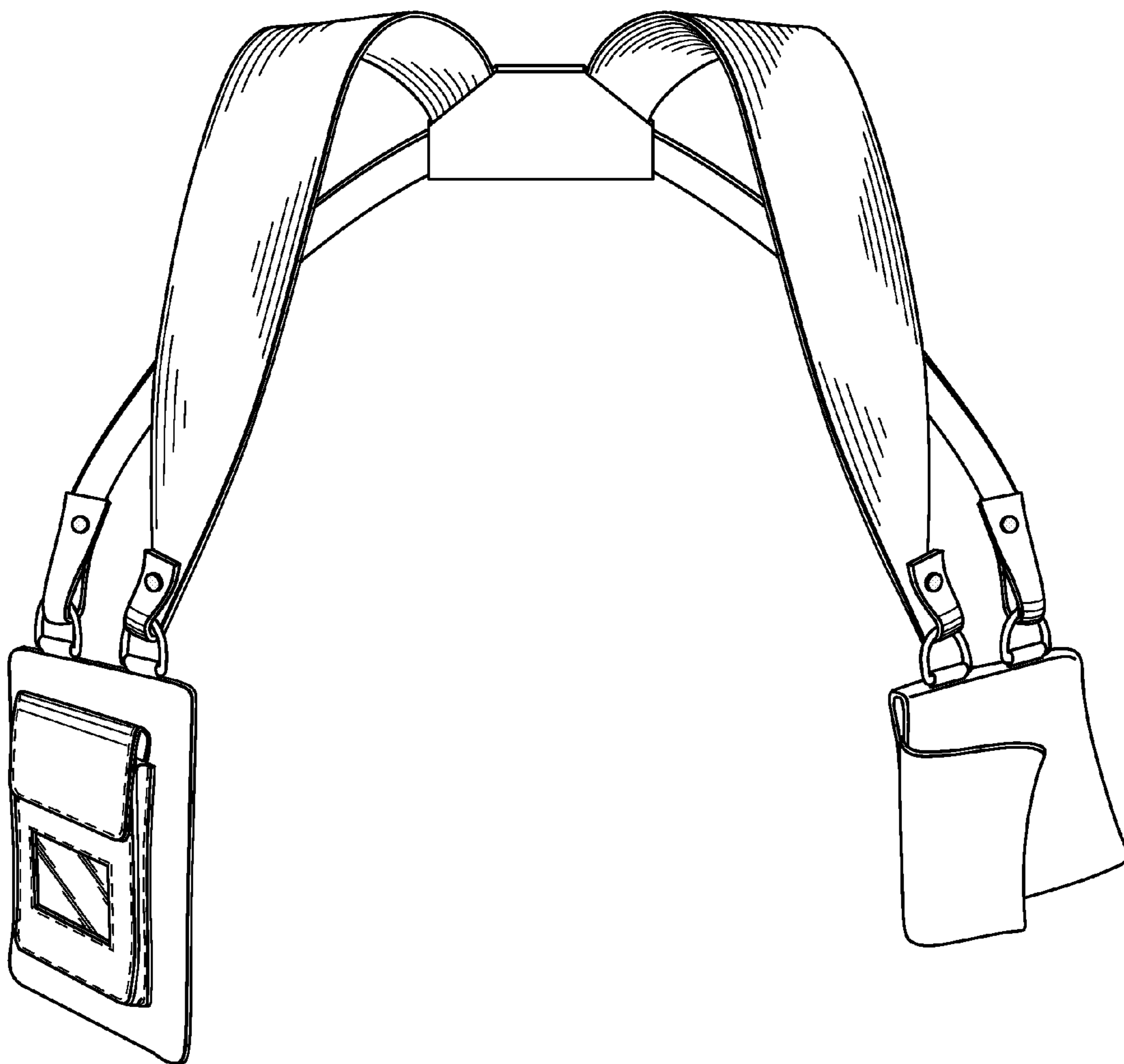

Fig. 5

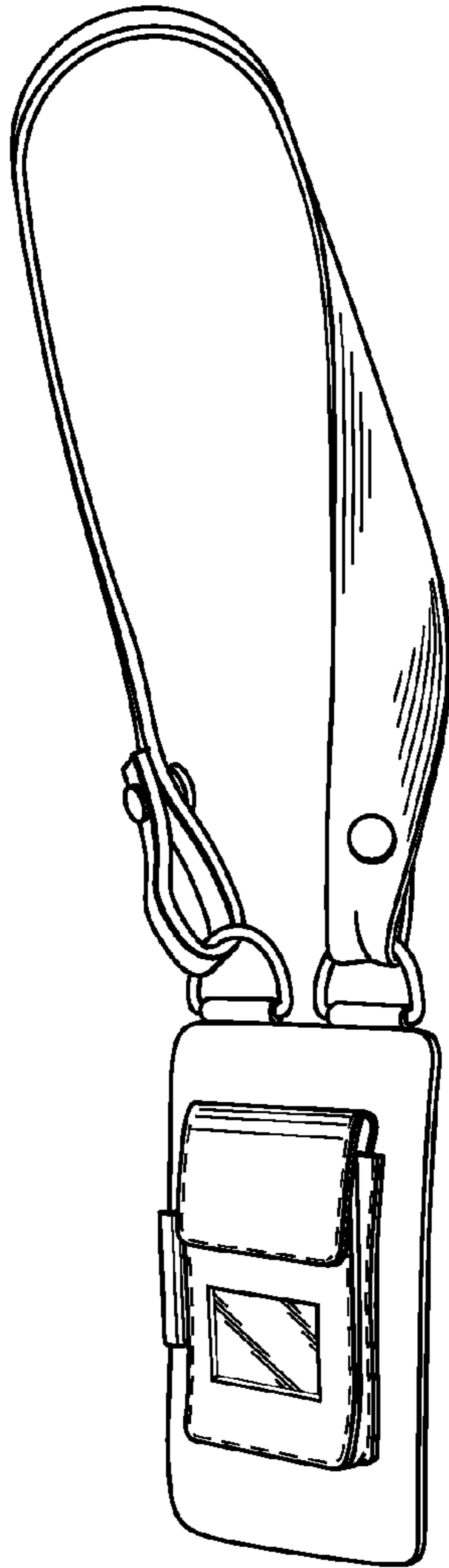

Fig. 6

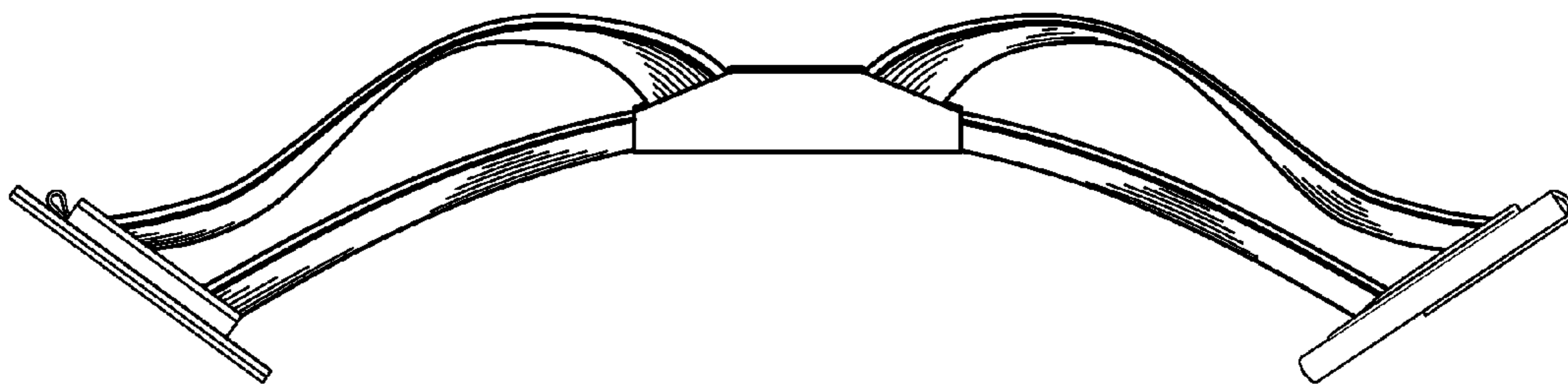
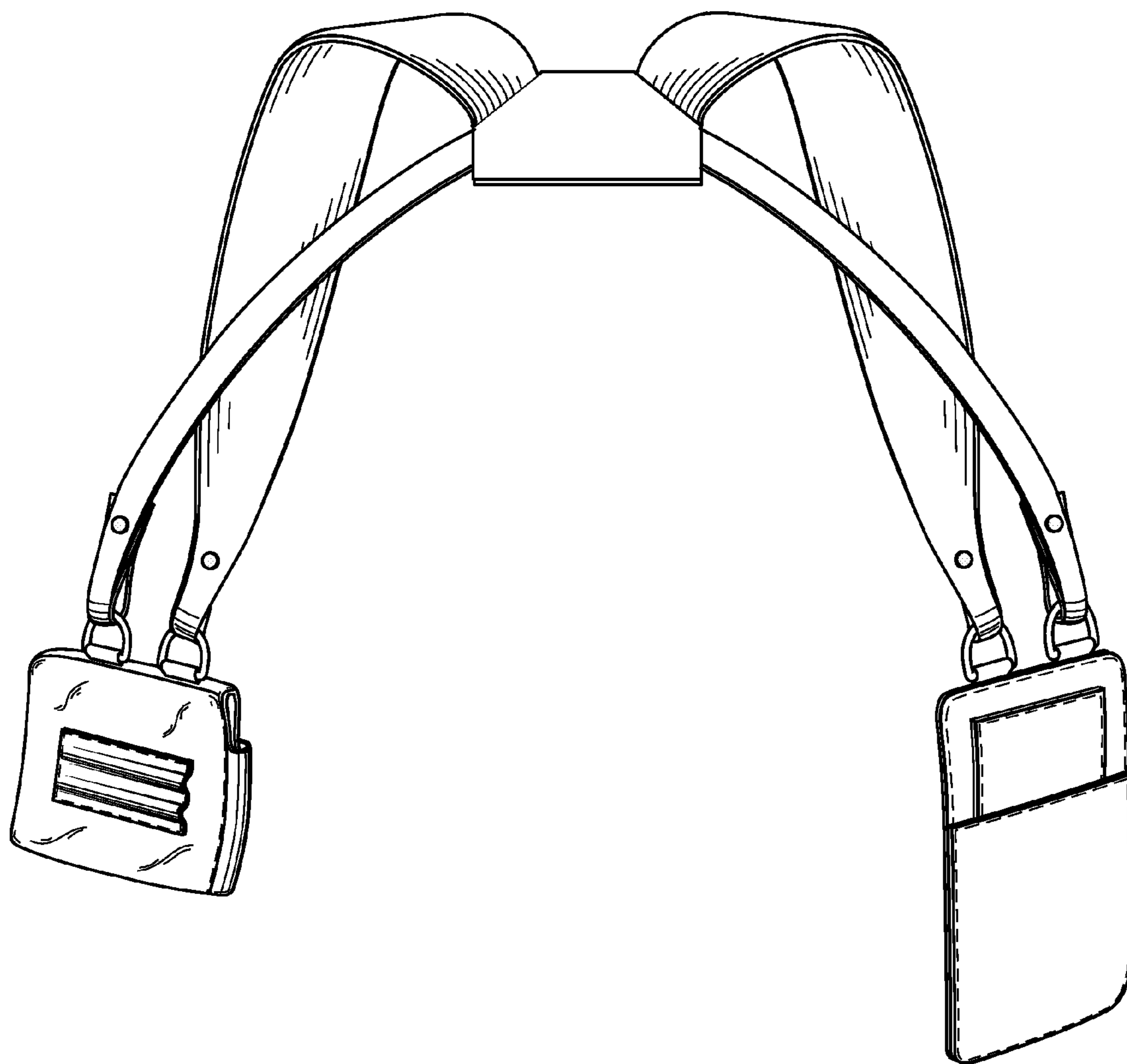
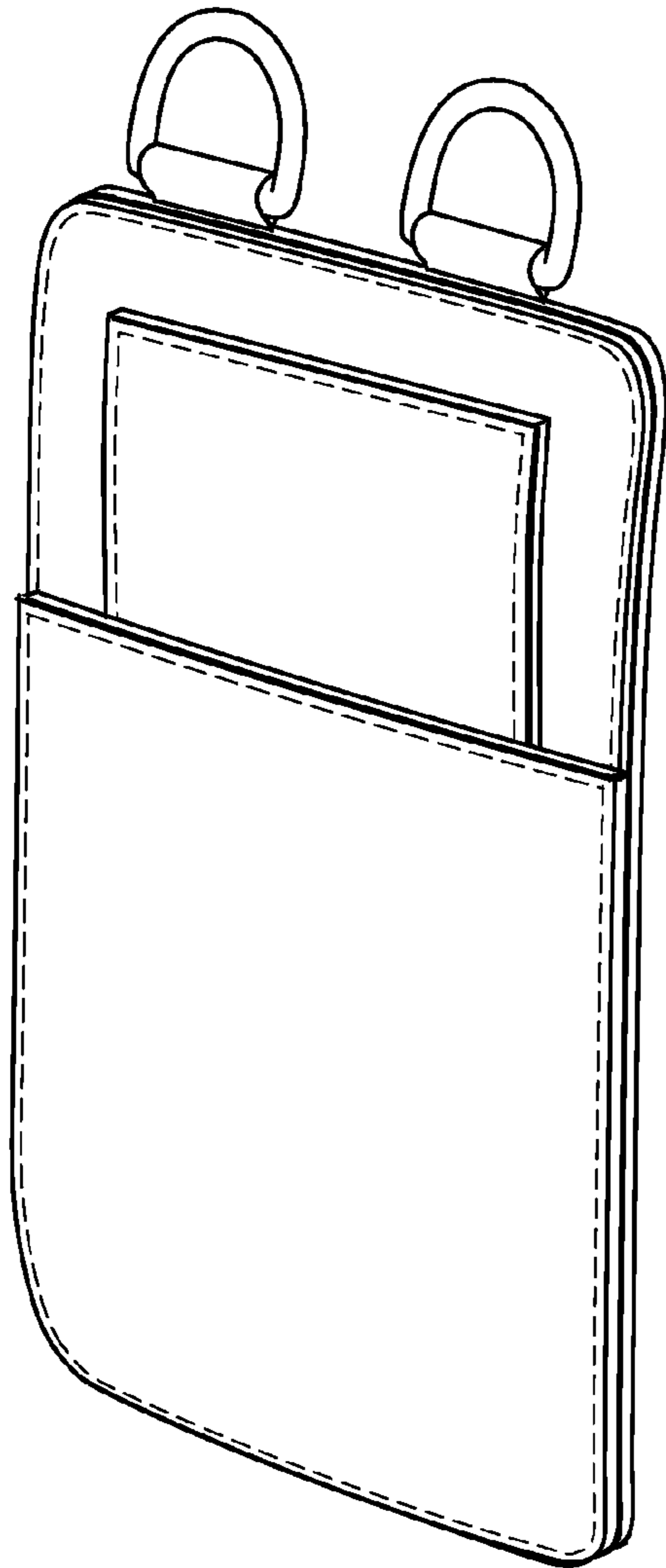



Fig. 7



**Fig. 8**



**Fig. 9**

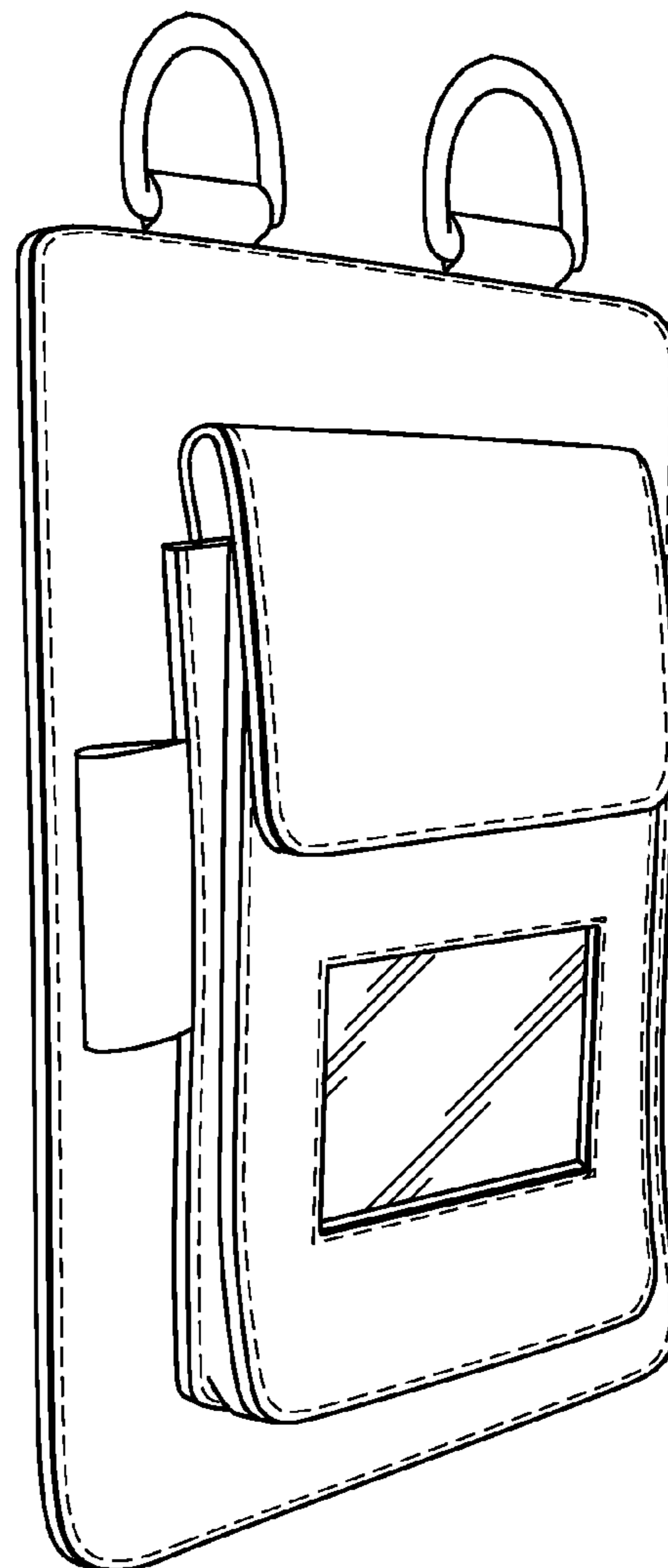

Fig. 10

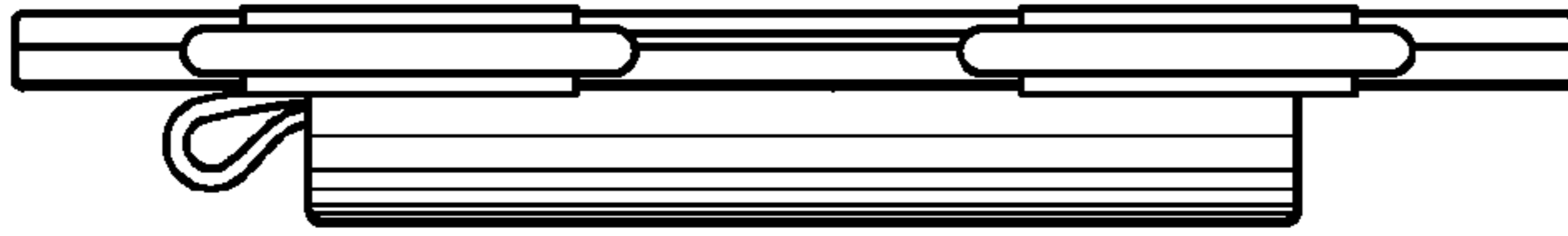

Fig. 11

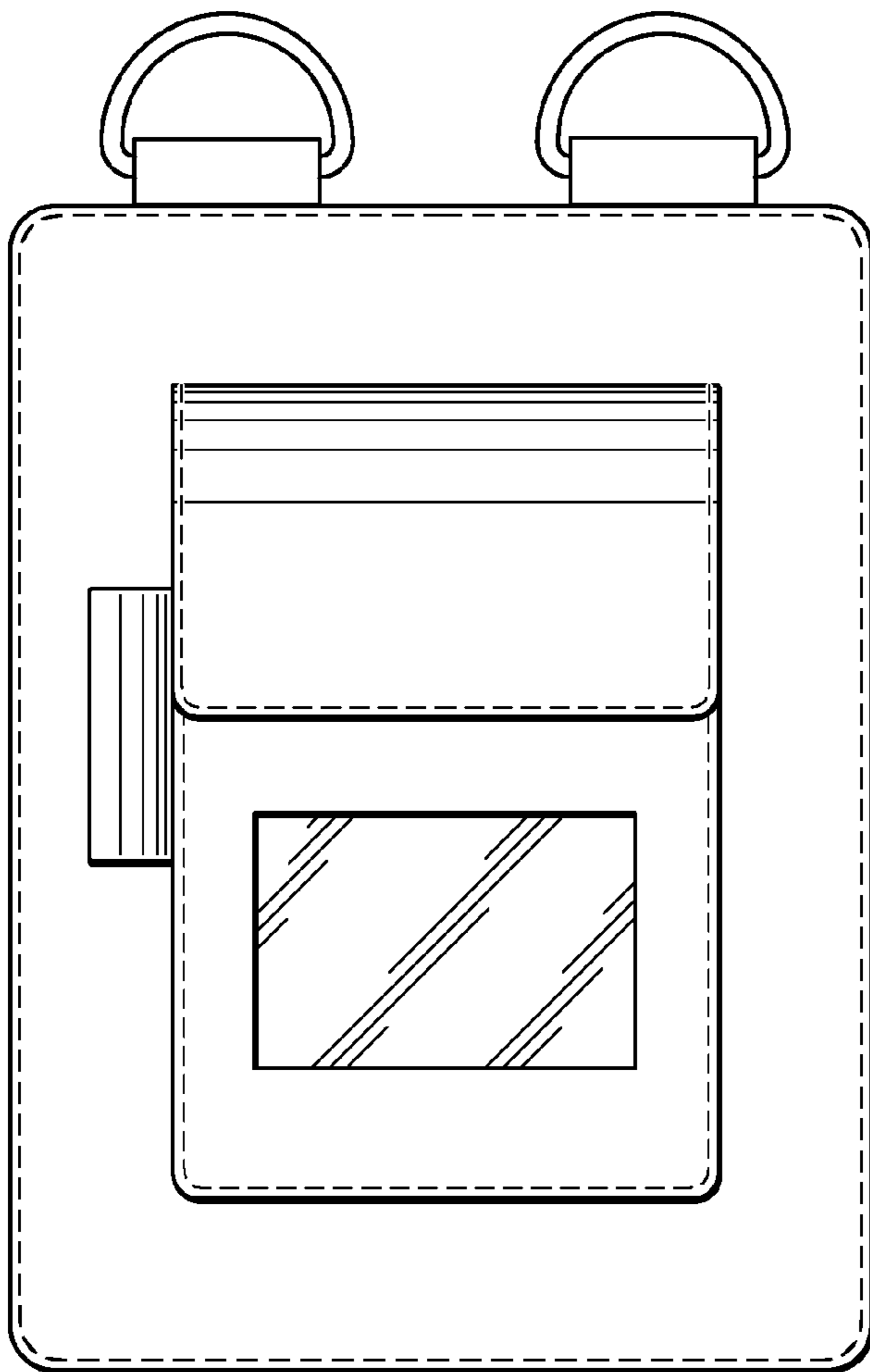

Fig. 12

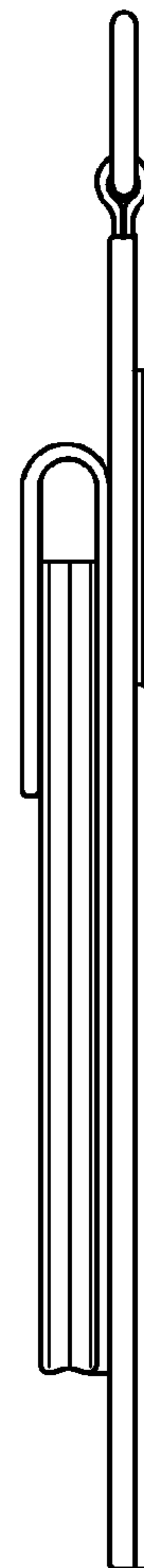



Fig. 13

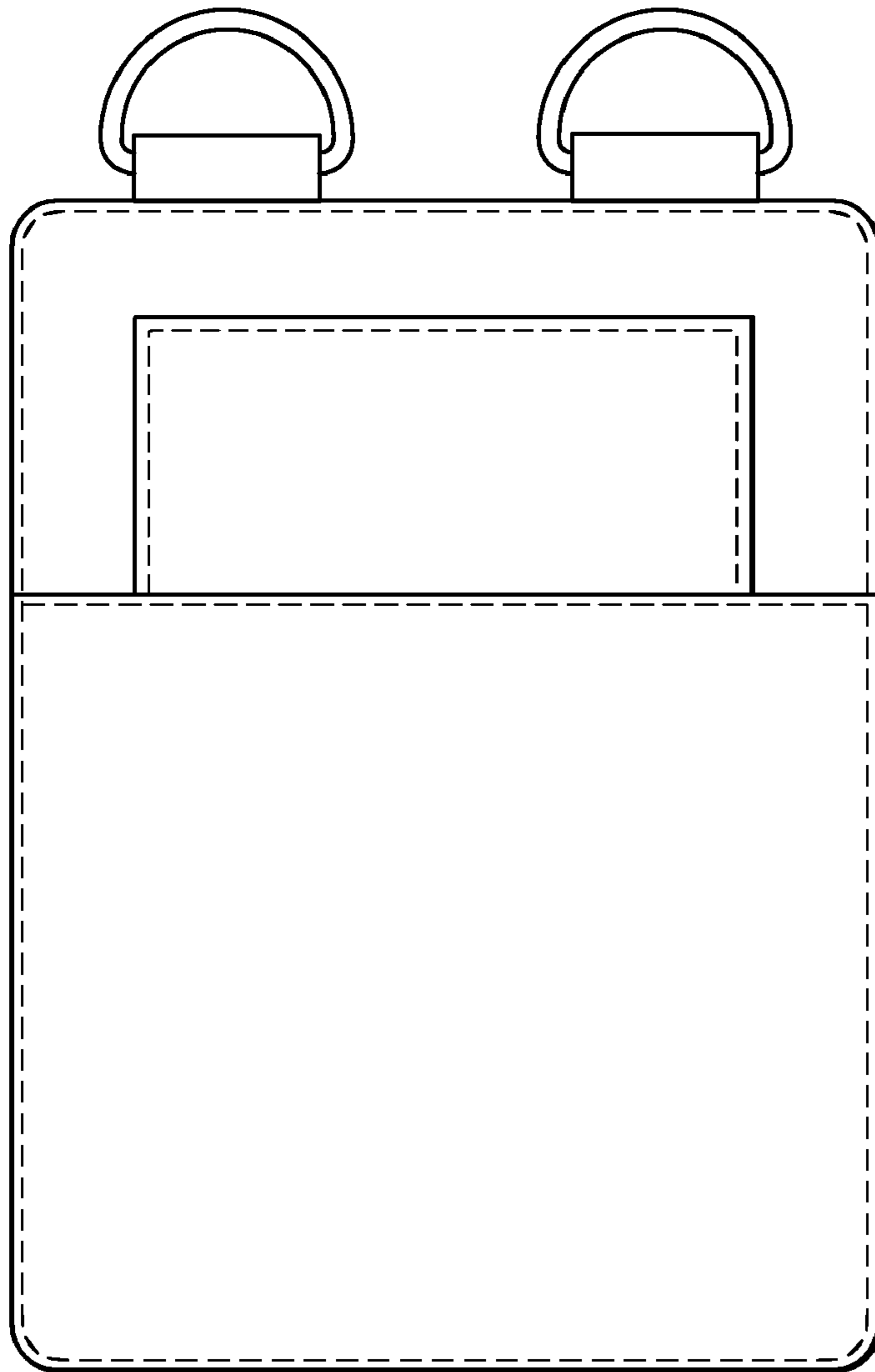

Fig. 14

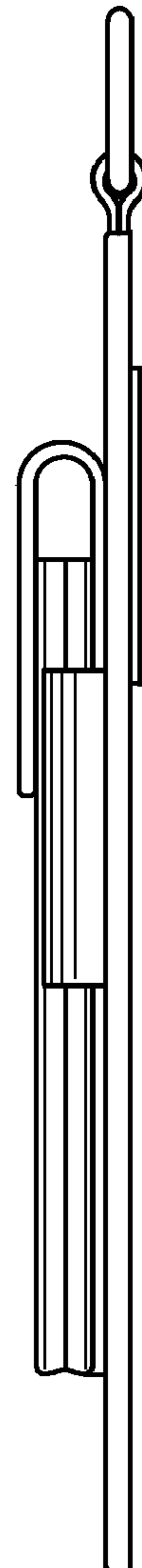
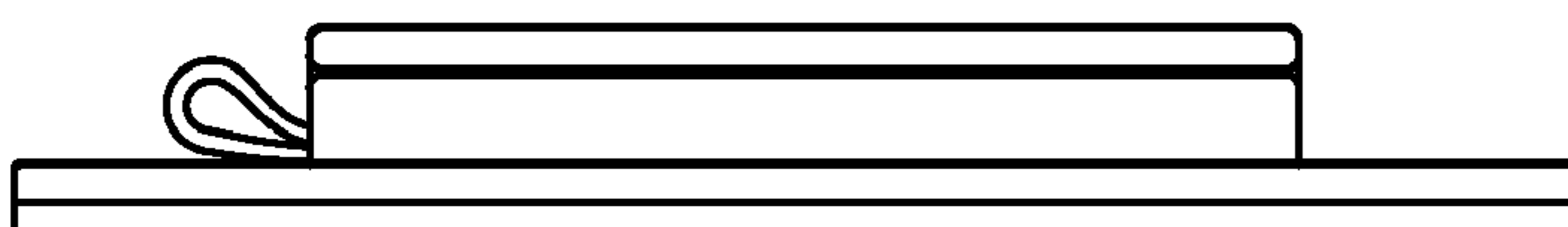
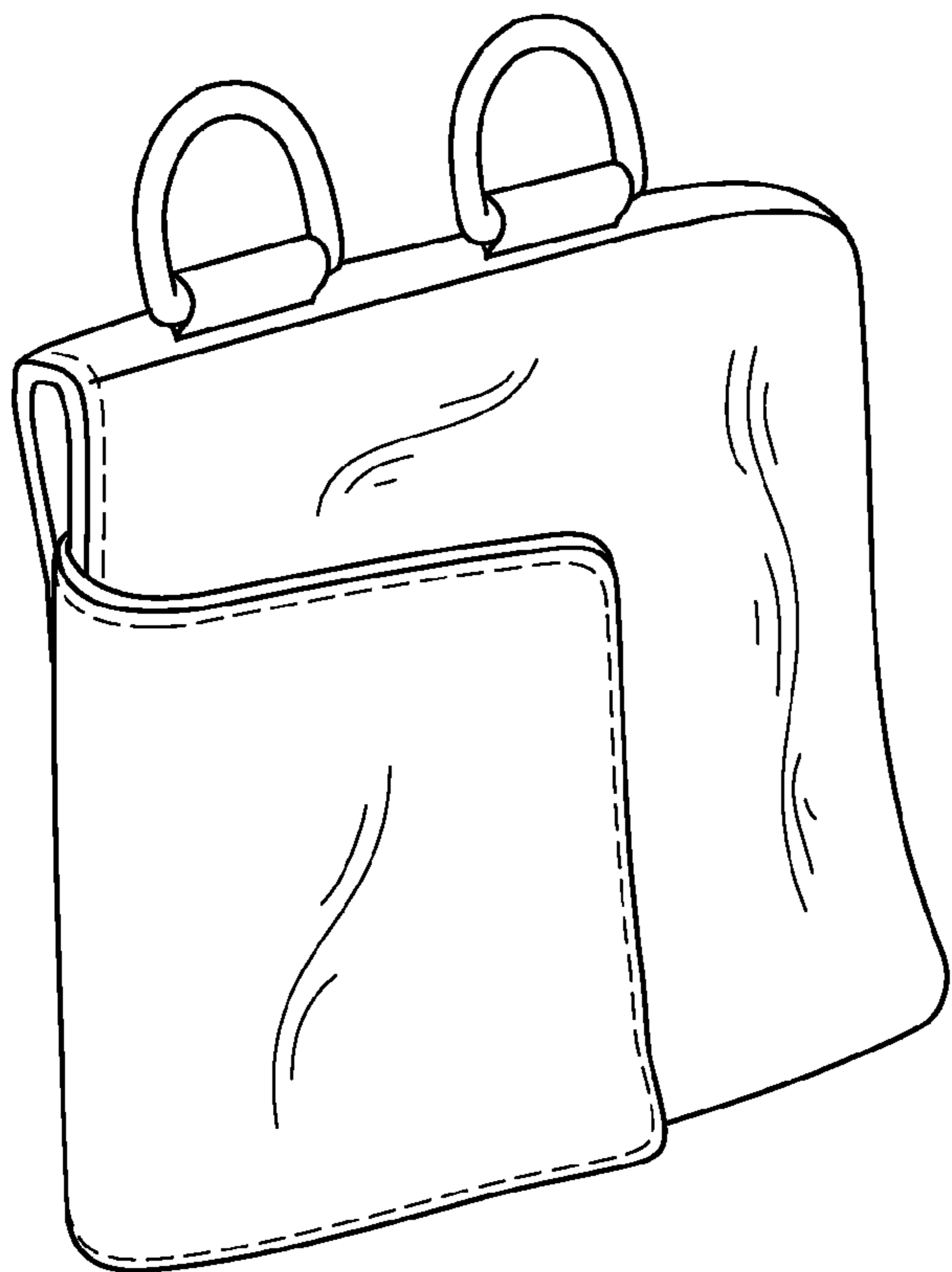

Fig. 15



**Fig. 16**



**Fig. 17**

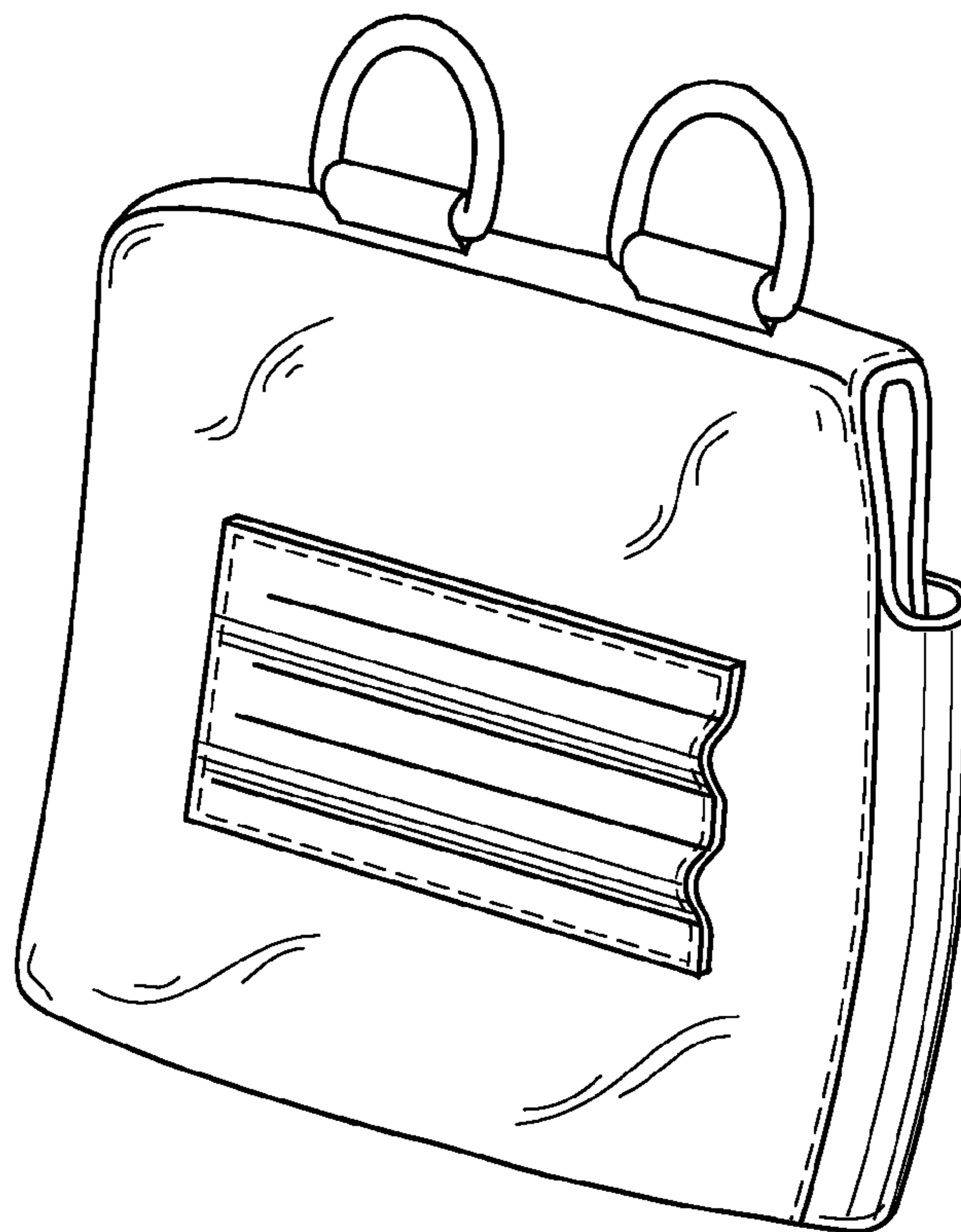

Fig. 18



Fig. 19

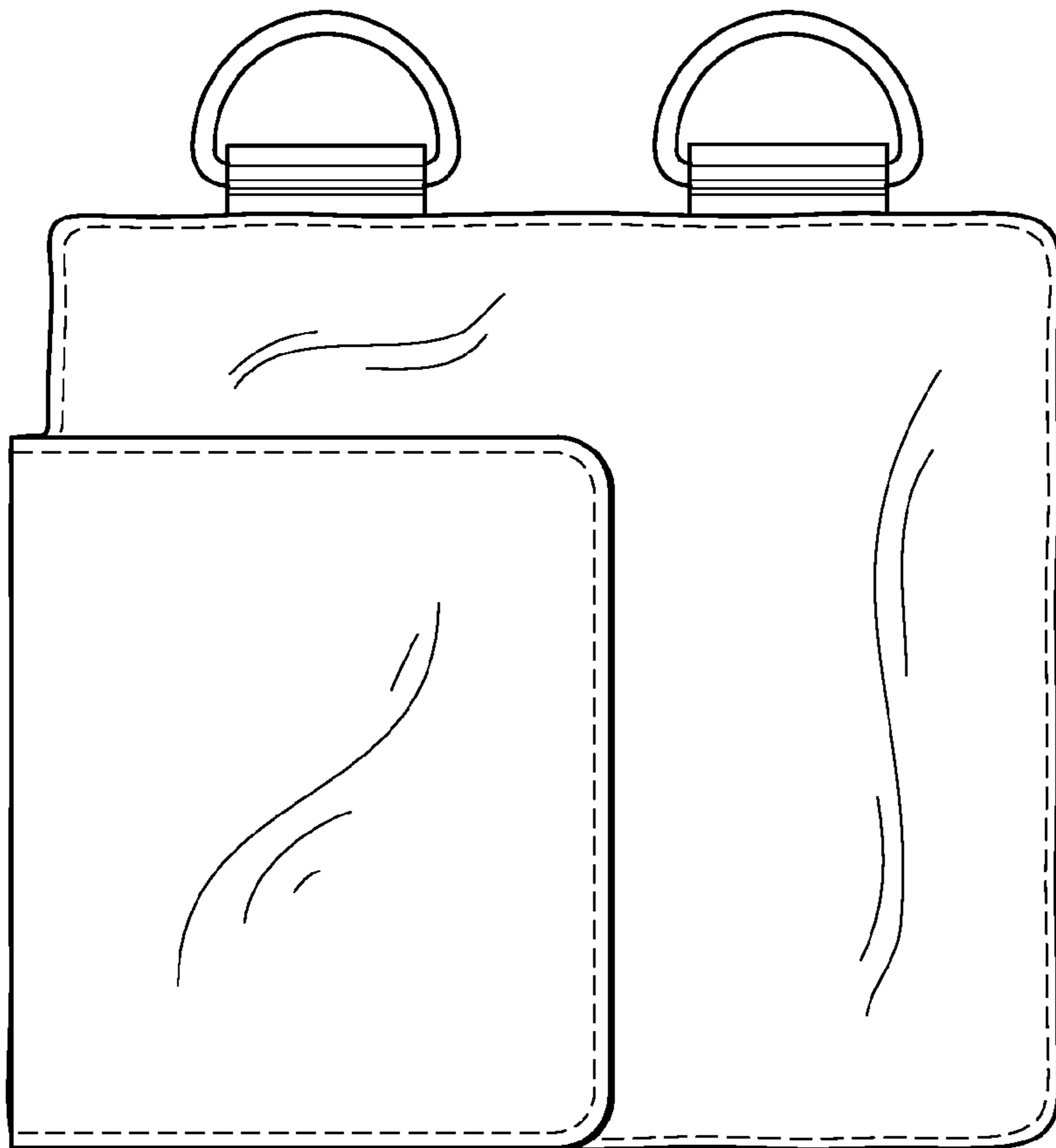

Fig. 20



Fig. 21

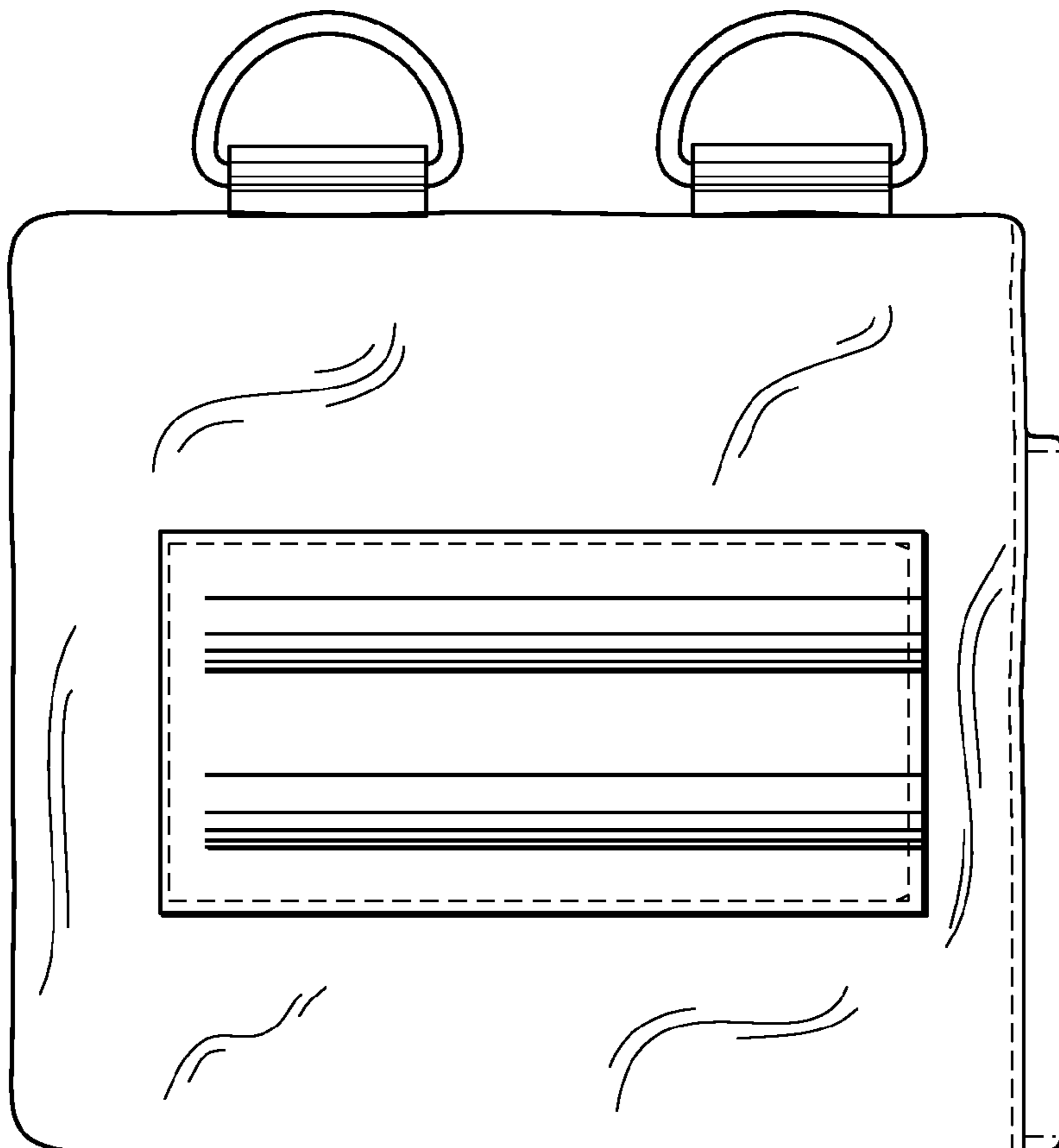

Fig. 22

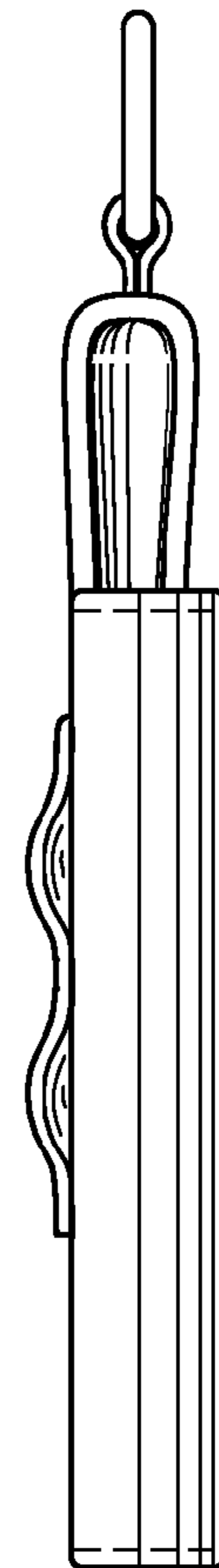

Fig. 23

