



US00D594071S

(12) **United States Design Patent**  
**Jinno et al.**

(10) **Patent No.:** **US D594,071 S**  
(45) **Date of Patent:** **\*\* Jun. 9, 2009**

(54) **RADIO REMOTE CONTROL UNIT**

(75) Inventors: **Eiji Jinno**, Chiba (JP); **Noriaki Morita**, Chiba (JP)

(73) Assignee: **Futaba Corporation**, Mobarashi, Chiba-ken (JP)

(\*\*) Term: **14 Years**

(21) Appl. No.: **29/322,403**

(22) Filed: **Aug. 4, 2008**

(51) **LOC (9) Cl.** ..... **21-01**

(52) **U.S. Cl.** ..... **D21/566**

(58) **Field of Classification Search** ..... D21/324,  
D21/329, 333, 566; D14/400, 401, 454,  
D14/217, 218, 358, 155; D13/168; 446/454-456;  
463/6, 7, 37, 38, 39, 46, 47  
See application file for complete search history.

(56) **References Cited**

**U.S. PATENT DOCUMENTS**

D322,103 S	12/1991	Kohno	
D322,297 S	12/1991	Kohno	
D342,297 S	12/1993	Kouno	
D344,553 S	2/1994	Arai	
D374,694 S	10/1996	Arai	
D395,472 S	6/1998	Kanetsuna et al.	
D397,169 S	8/1998	Kanetsuna et al.	
D447,778 S *	9/2001	Bao	..... D21/566
D471,603 S	3/2003	Morita et al.	

D514,172 S	1/2006	Jinno et al.	
D517,129 S	3/2006	Yamamoto et al.	
D521,573 S	5/2006	Jinno et al.	
D546,905 S	7/2007	Arai et al.	
7,250,844 B2	7/2007	Arai et al.	
D568,420 S *	5/2008	Hamasaki	..... D21/566
D570,924 S *	6/2008	Wai	..... D21/566
D573,204 S	7/2008	Arai et al.	

\* cited by examiner

*Primary Examiner*—Holly H Baynham

*Assistant Examiner*—Cynthia M Chin

(74) *Attorney, Agent, or Firm*—Quarles & Brady LLP

(57) **CLAIM**

We claim the ornamental design for a radio remote control unit, as shown and described.

**DESCRIPTION**

FIG. 1 is a front side perspective view of a radio remote control unit showing our new design;

FIG. 2 is a rear side perspective view thereof;

FIG. 3 is a front elevational view thereof;

FIG. 4 is a rear elevational view thereof;

FIG. 5 is a right side elevational view thereof;

FIG. 6 is a left side elevational view thereof;

FIG. 7 is a top plan view thereof; and,

FIG. 8 is a bottom plan view thereof.

**1 Claim, 8 Drawing Sheets**

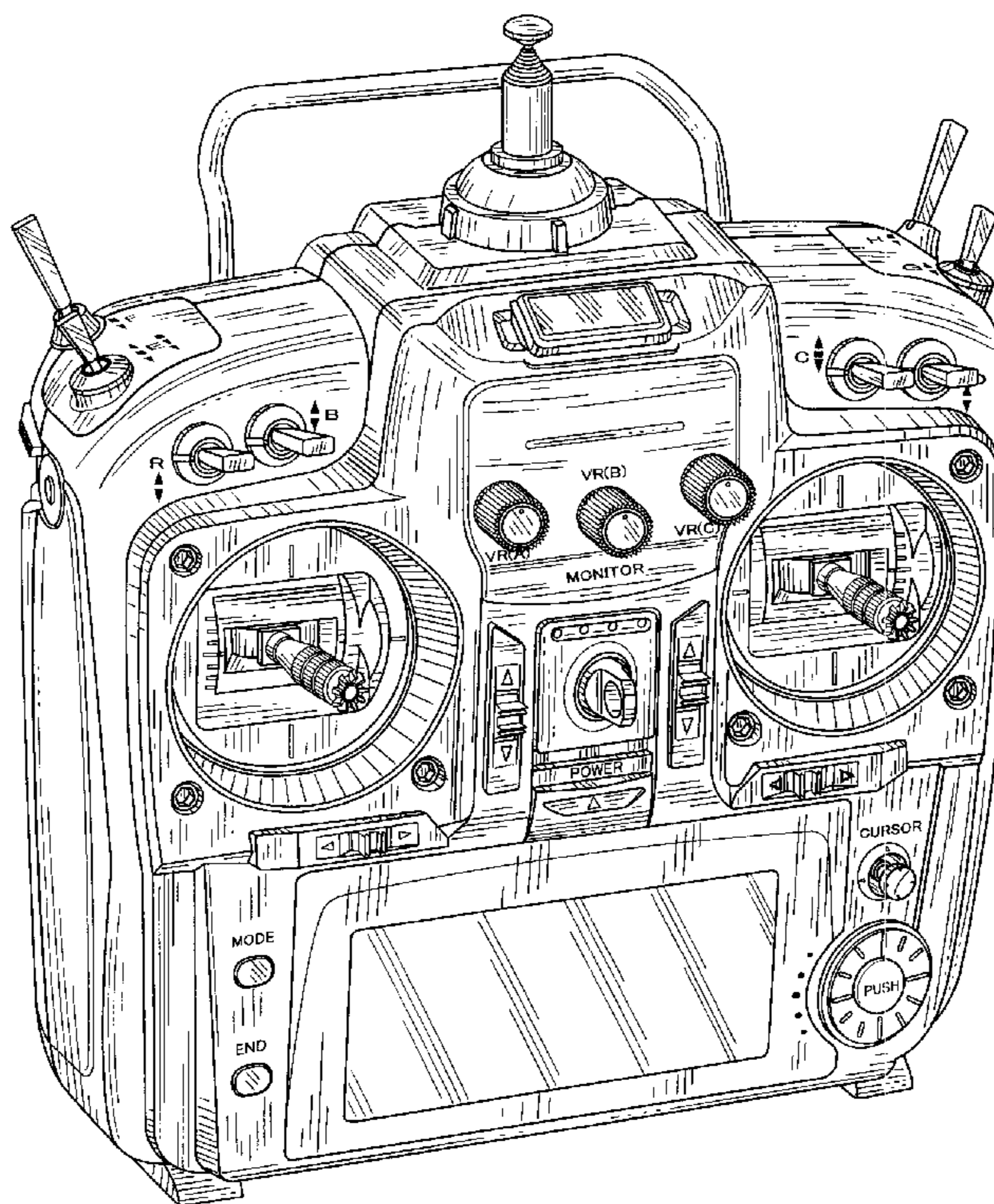
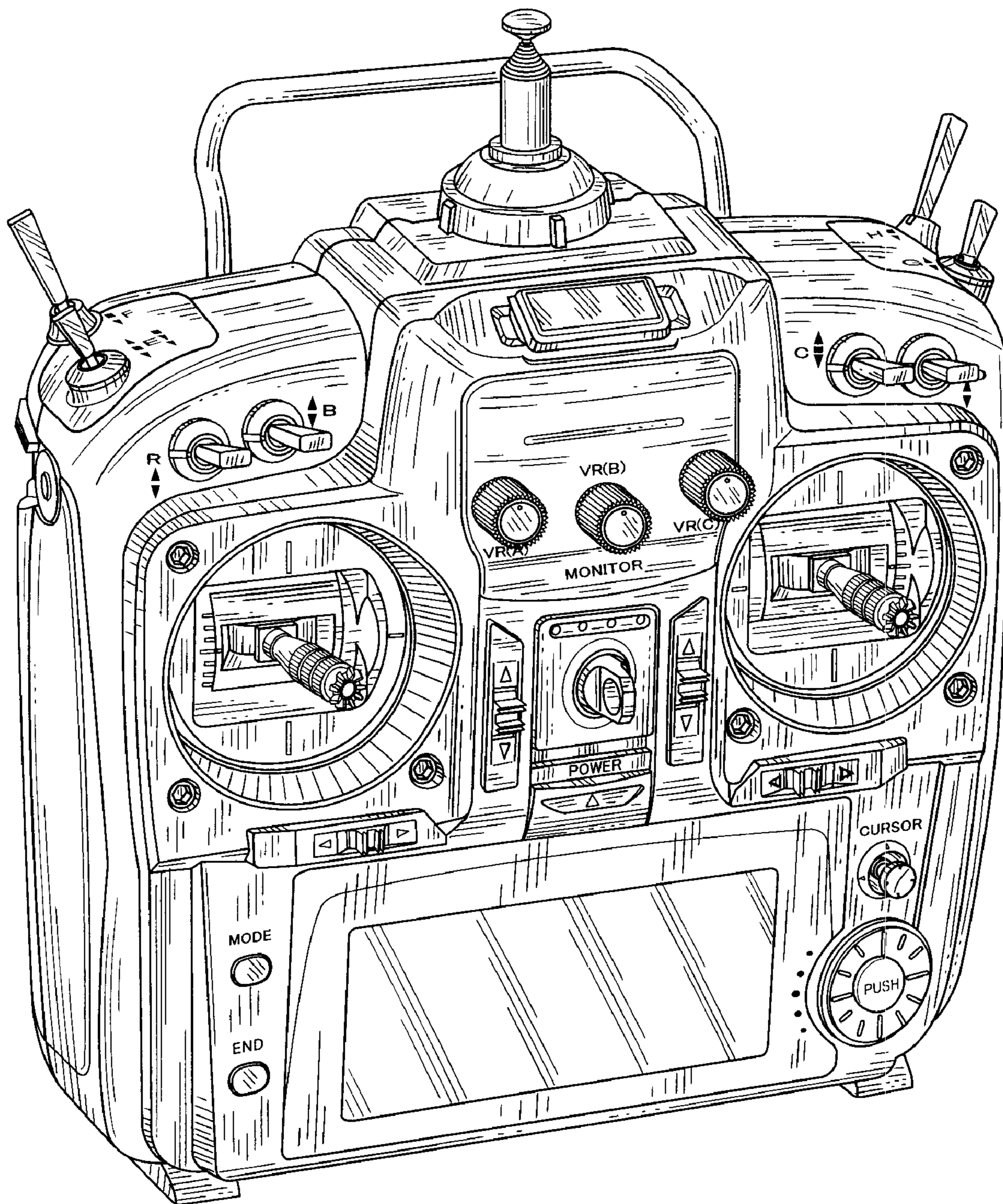

FIG. 1





**FIG.2**

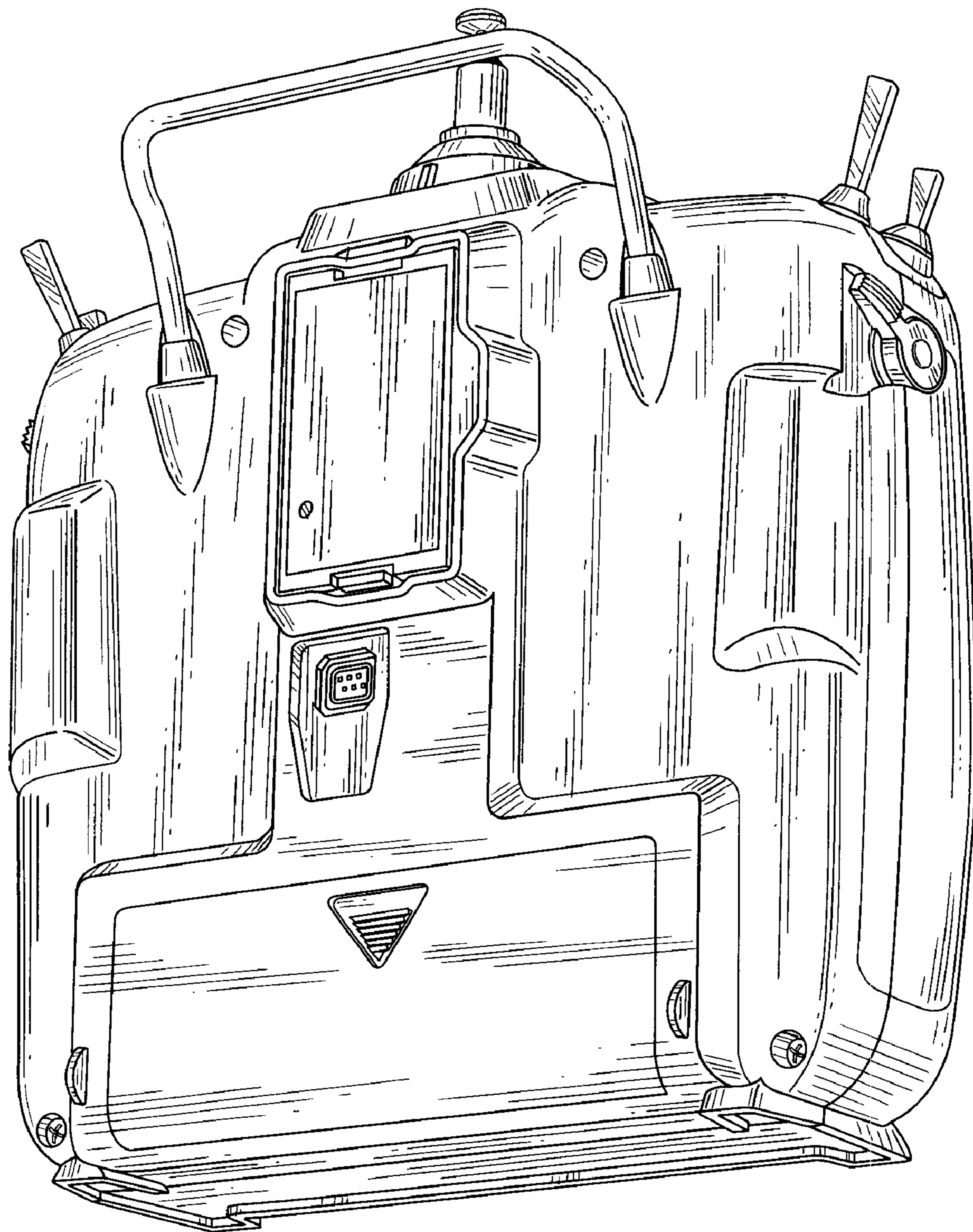

FIG.3

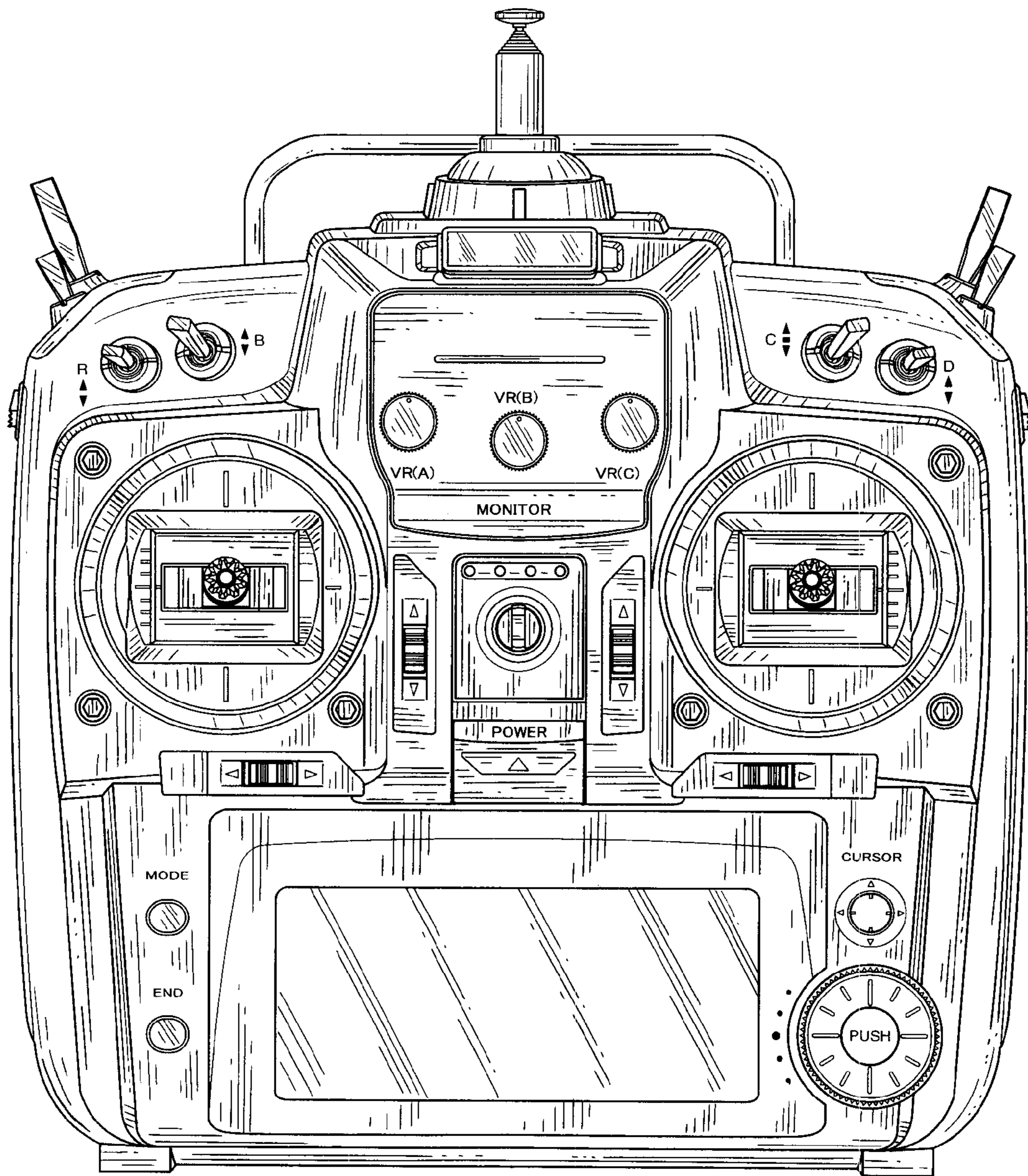

FIG.4

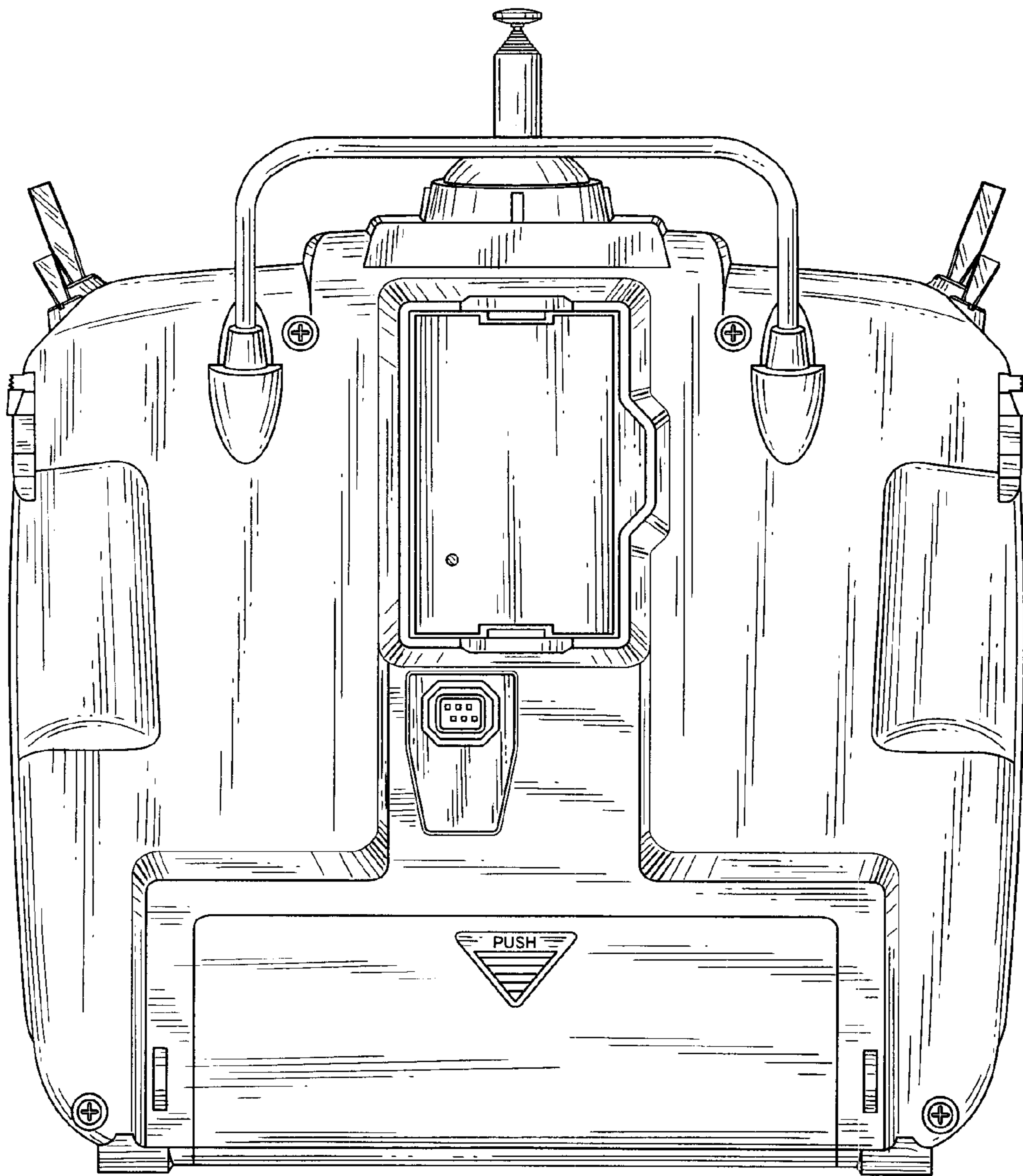
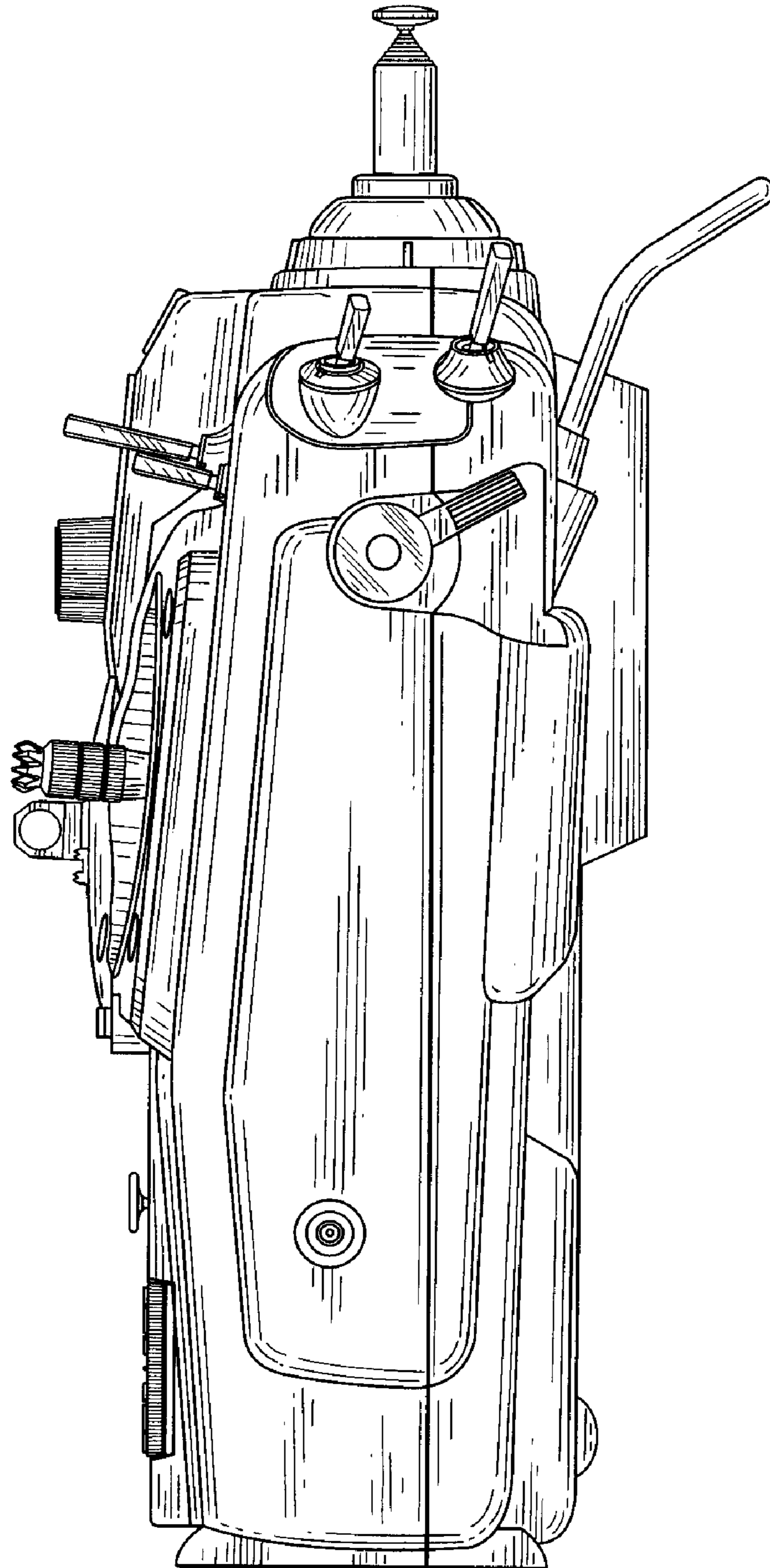

FIG.5





**FIG.6**

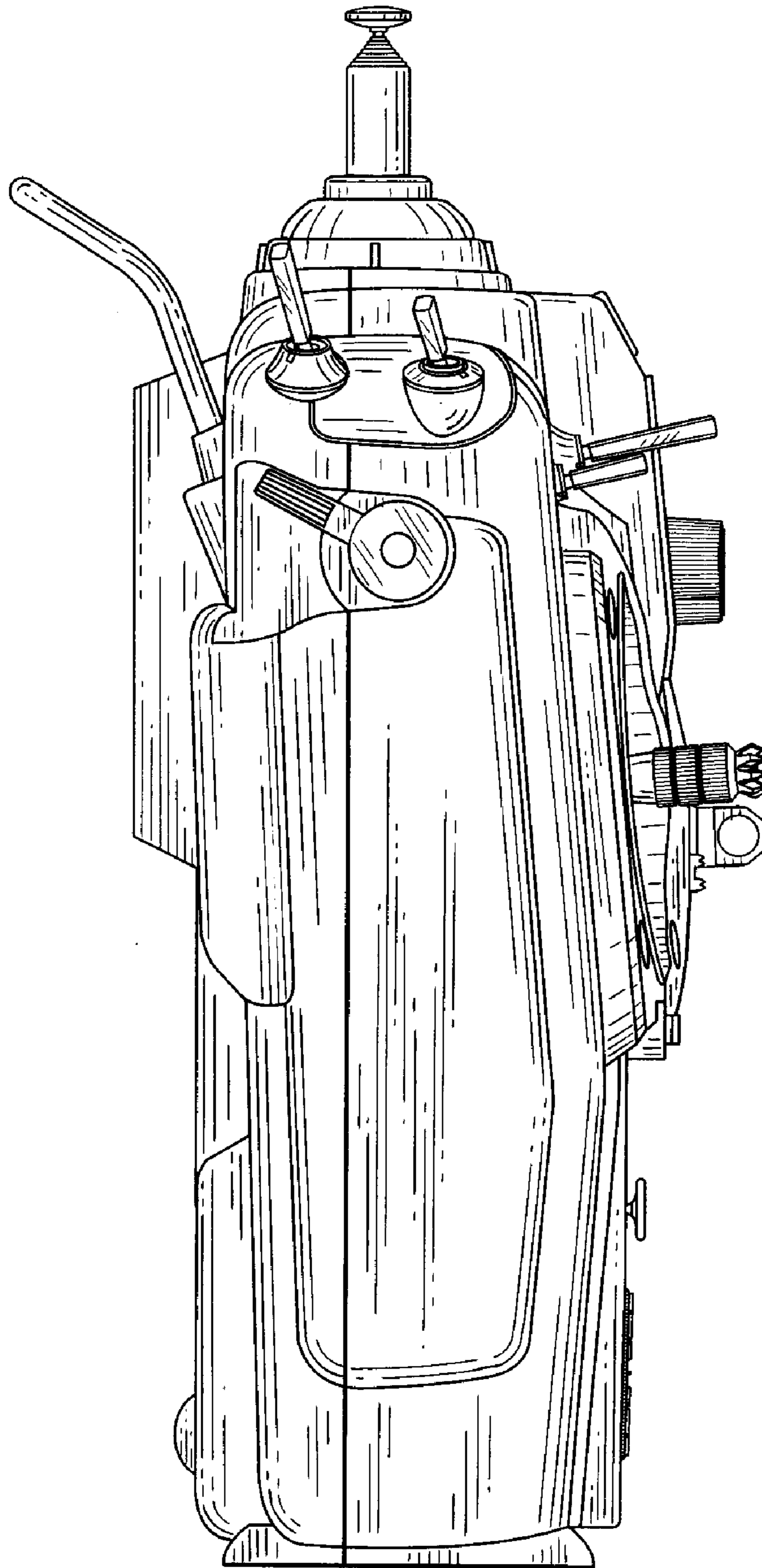
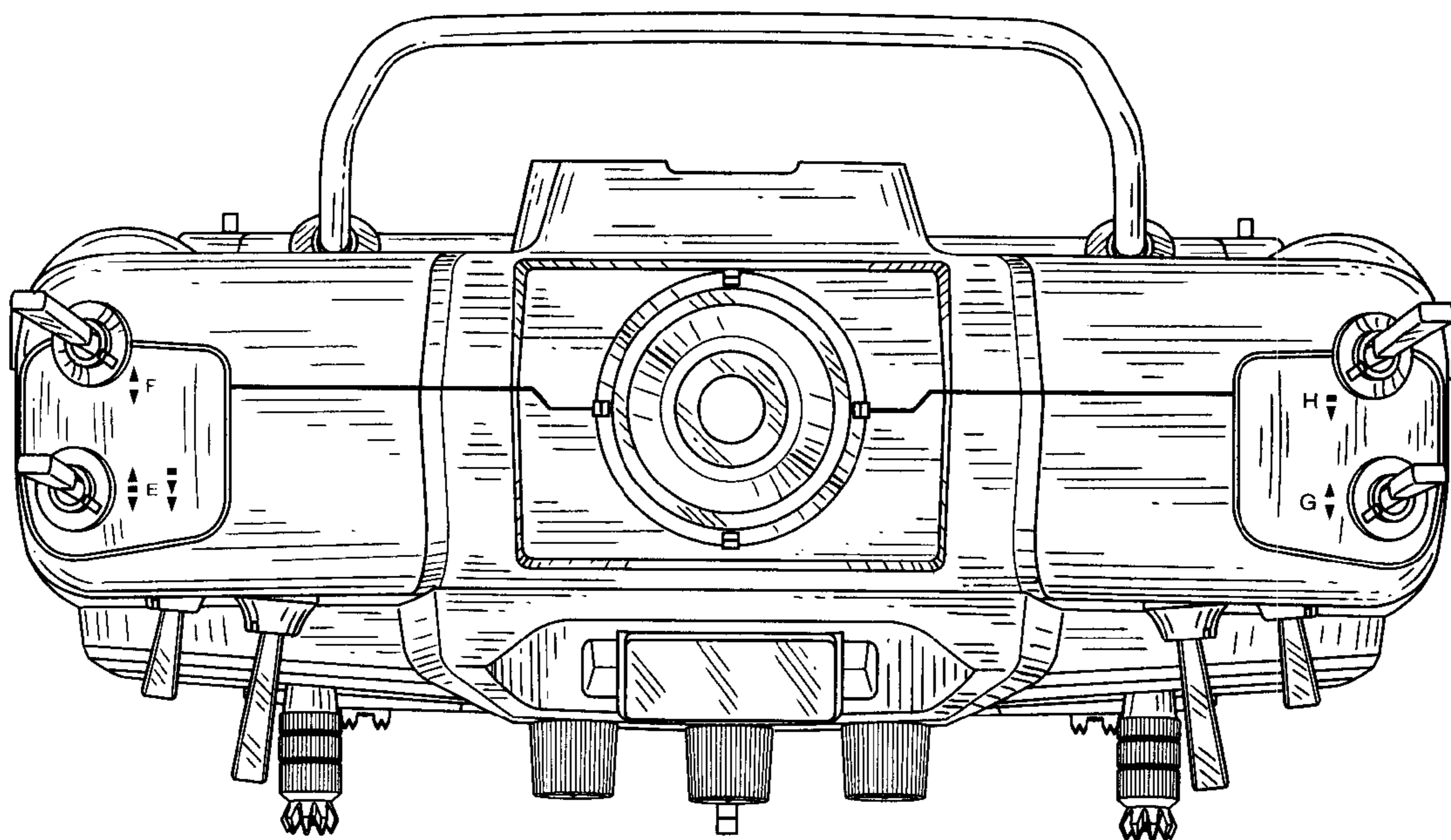

FIG.7





**FIG.8**

