



US00D594034S

(12) **United States Design Patent**
Bernloehr et al.

(10) **Patent No.:** **US D594,034 S**
(45) **Date of Patent:** **** Jun. 9, 2009**

(54) **TROLLING MOTOR MOUNT**

(75) Inventors: **Darrel A. Bernloehr**, Mankato, MN (US); **Craig E. Turek**, St. Peter, MN (US)

(73) Assignee: **Johnson Outdoors Inc.**, Racine, WI (US)

(**) Term: **14 Years**

(21) Appl. No.: **29/291,731**

(22) Filed: **Sep. 12, 2007**

(51) **LOC (9) Cl.** **15-01**

(52) **U.S. Cl.** **D15/5**

(58) **Field of Classification Search** D15/4-5;
440/61 R, 61 F, 61 T, 62-63, 53; 248/640,
248/642

See application file for complete search history.

(56) **References Cited**

U.S. PATENT DOCUMENTS

3,870,258	A	3/1975	Shimanckas et al.	
3,930,461	A	1/1976	Brock et al.	
3,954,080	A	5/1976	Weaver	
3,999,500	A	12/1976	Friedel et al.	
4,008,680	A	2/1977	Alexander, Jr.	
4,129,088	A	12/1978	Foley, Jr.	
4,154,417	A	5/1979	Foley, Jr.	
4,268,258	A *	5/1981	Beem	440/63
4,410,161	A	10/1983	Booty	
4,634,390	A	1/1987	Baird	
4,708,670	A *	11/1987	Peters	440/6
4,729,745	A	3/1988	Edwards	
4,733,848	A	3/1988	Slattery	
4,819,905	A	4/1989	McCain	
4,966,566	A	10/1990	Baird	
5,112,258	A	5/1992	Folsom	
5,405,274	A	4/1995	Cook, III	
5,669,794	A *	9/1997	Knight et al.	440/63
6,224,437	B1	5/2001	Griffith, Sr. et al.	
6,394,408	B1	5/2002	Henderson et al.	
6,524,144	B2	2/2003	Pasley	

6,808,431	B1	10/2004	Neely	
7,004,804	B2	2/2006	Bernloehr et al.	
7,160,163	B2 *	1/2007	Gai	440/61 S
7,195,526	B2	3/2007	Bernloehr et al.	
7,285,029	B1 *	10/2007	Janitz	440/6
7,407,419	B2 *	8/2008	Douglas	440/53
2008/0029683	A1 *	2/2008	Draghici	248/640

* cited by examiner

Primary Examiner—Ian Simmons

Assistant Examiner—Wan Laymon

(74) *Attorney, Agent, or Firm*—Reinhart Boerner Van Deuren P.C.

(57) **CLAIM**

The ornamental design for a trolling motor mount, as shown and described.

DESCRIPTION

FIG. 1 is a perspective view in an open position;

FIG. 2 is a right side view in an open position;

FIG. 3 is a left side view in an open position;

FIG. 4 is a front view in an open position;

FIG. 5 is a rear view in an open position;

FIG. 6 is a top view in an open position;

FIG. 7 is a bottom plan view in an open position;

FIG. 8 is a perspective view in a closed position;

FIG. 9 is a right side view in a closed position;

FIG. 10 is a left side view in a closed position;

FIG. 11 is a front view in a closed position;

FIG. 12 is a rear view in a closed position;

FIG. 13 is a top view in a closed position; and,

FIG. 14 is a bottom view in a closed position.

The broken lines illustrate environmental structure of the trolling motor mount, which forms no part of the claimed design.

1 Claim, 8 Drawing Sheets

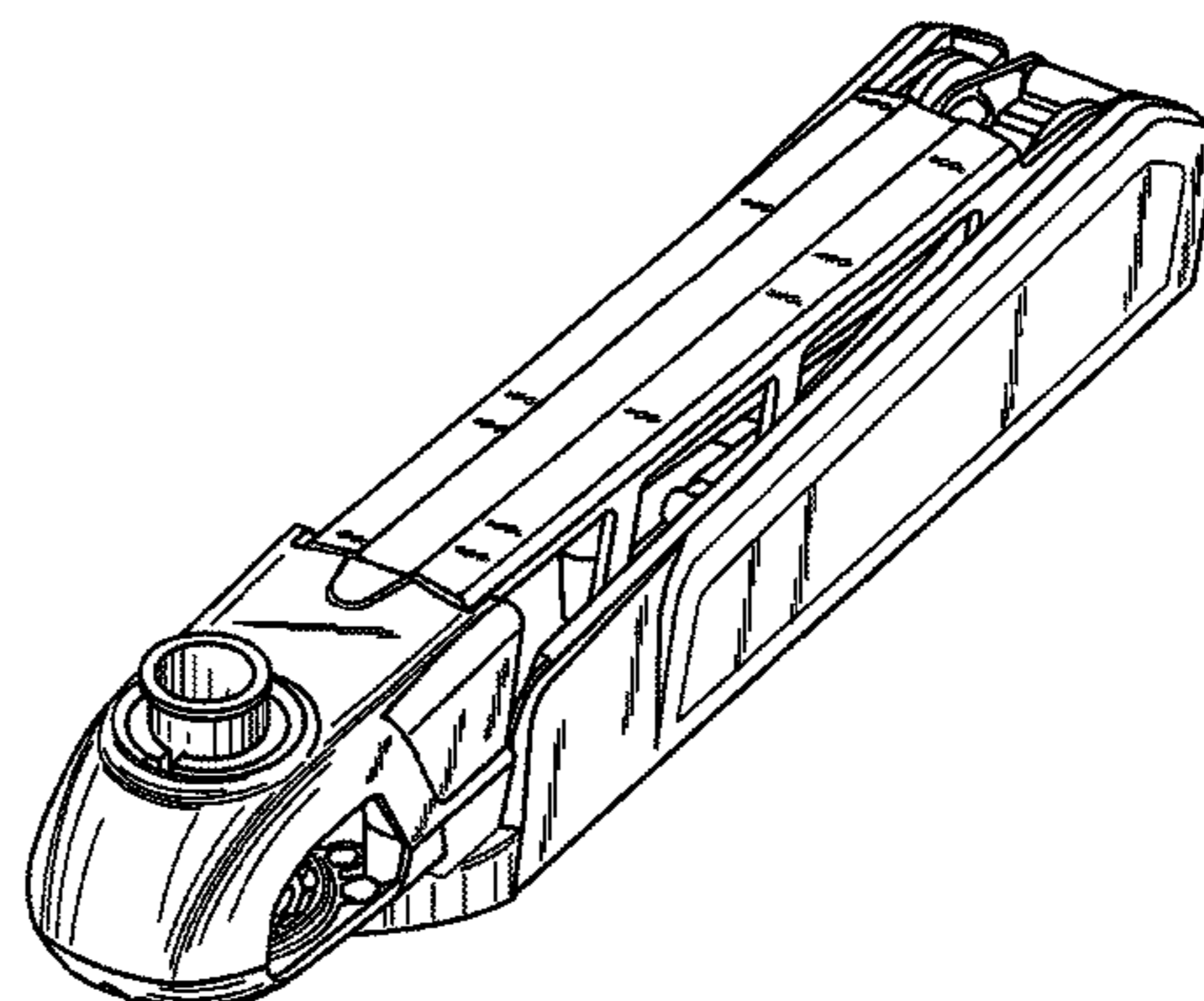
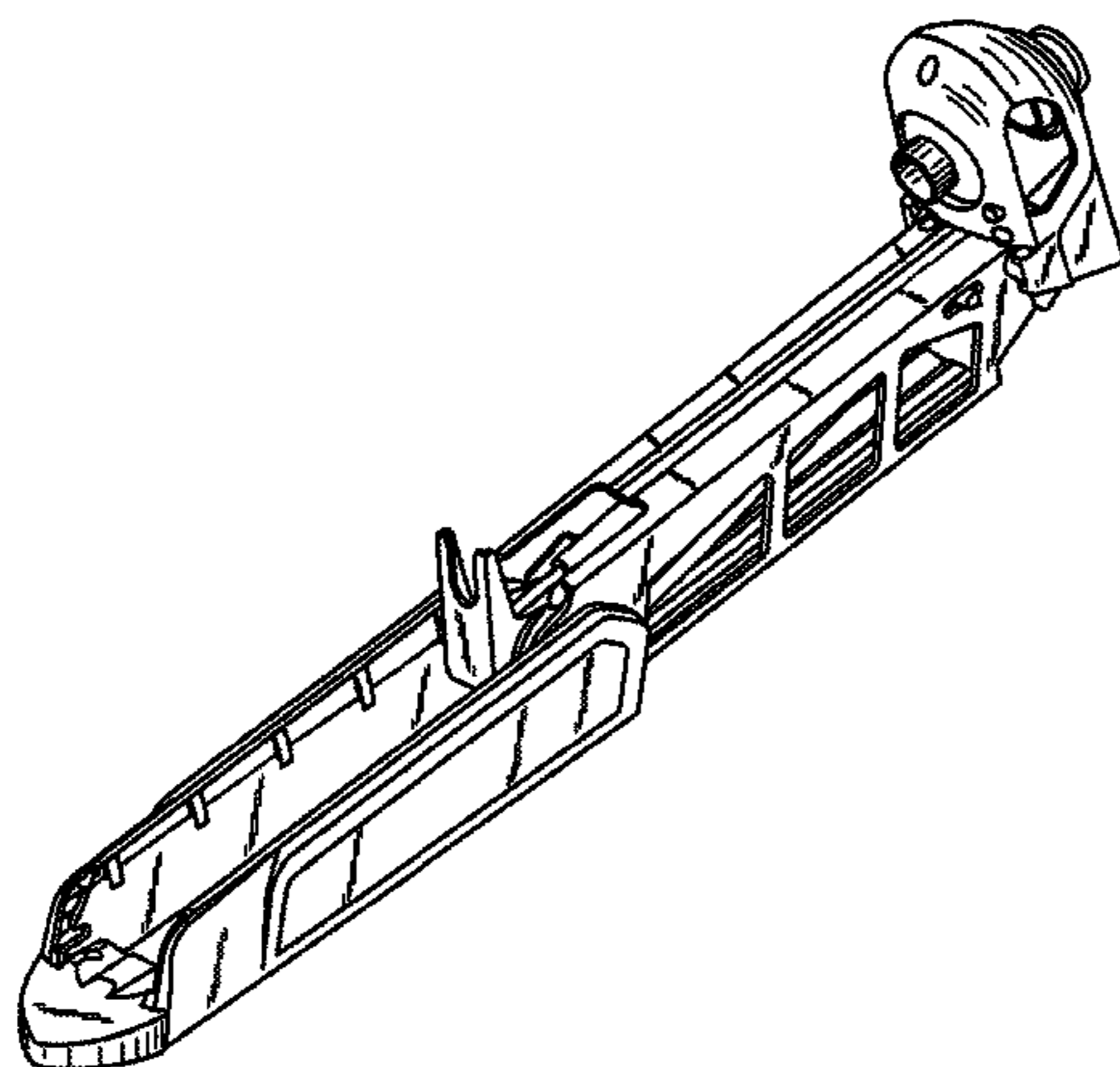

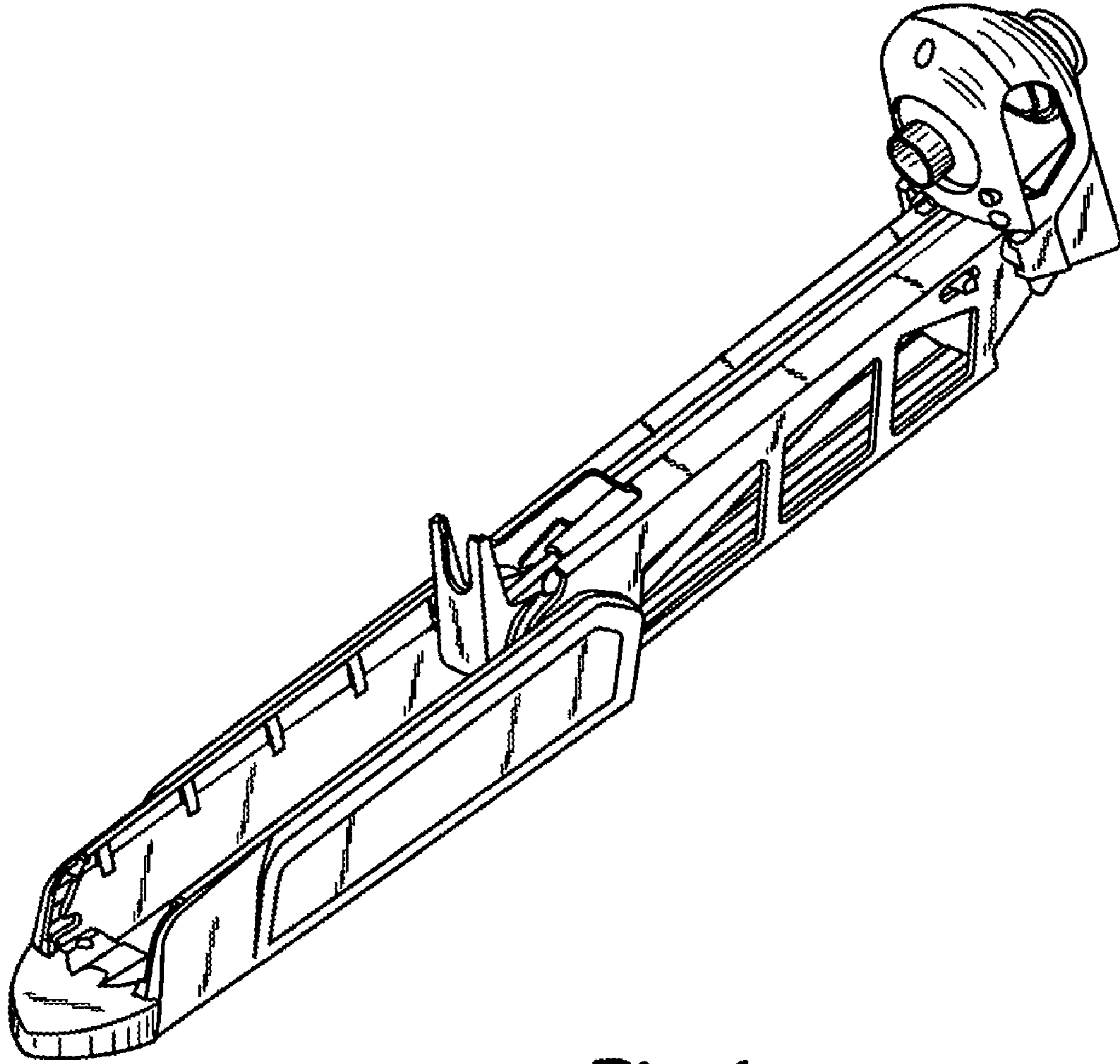

Fig. 1

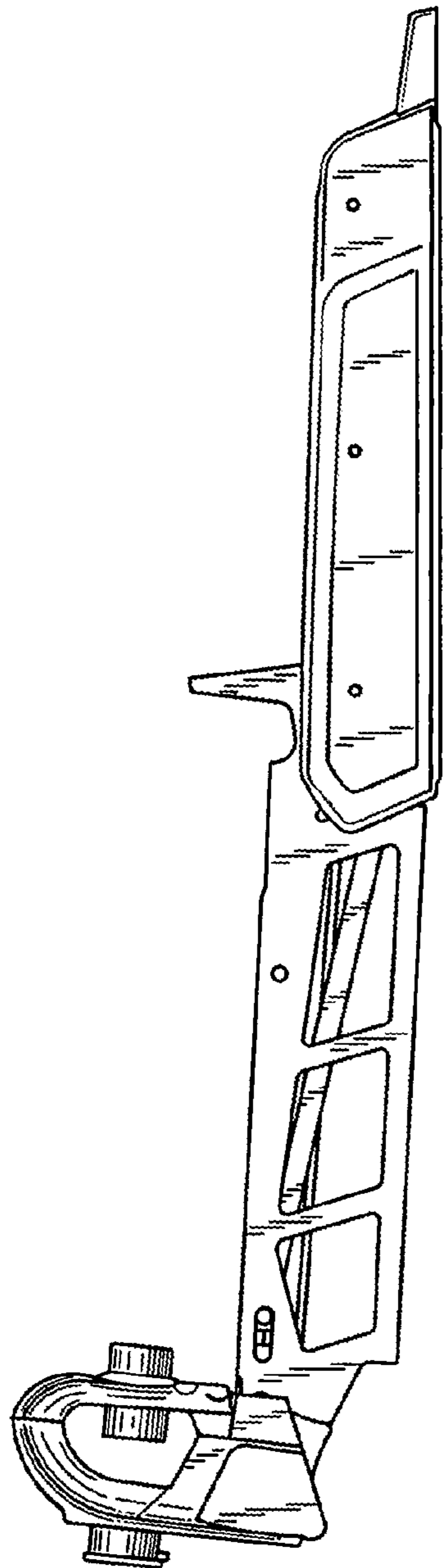

Fig. 2

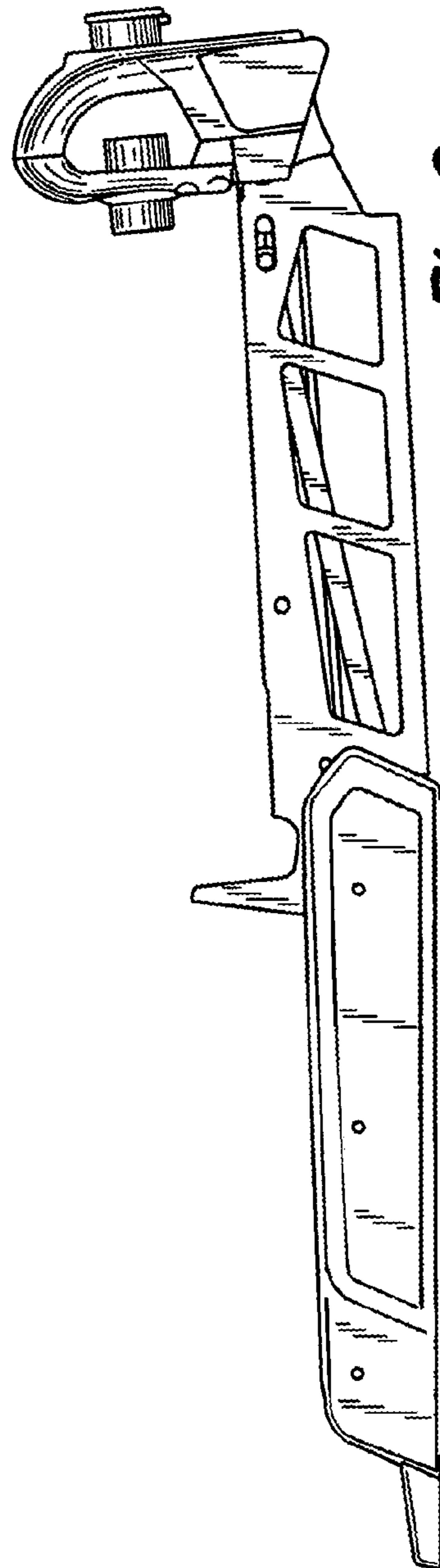

Fig. 3

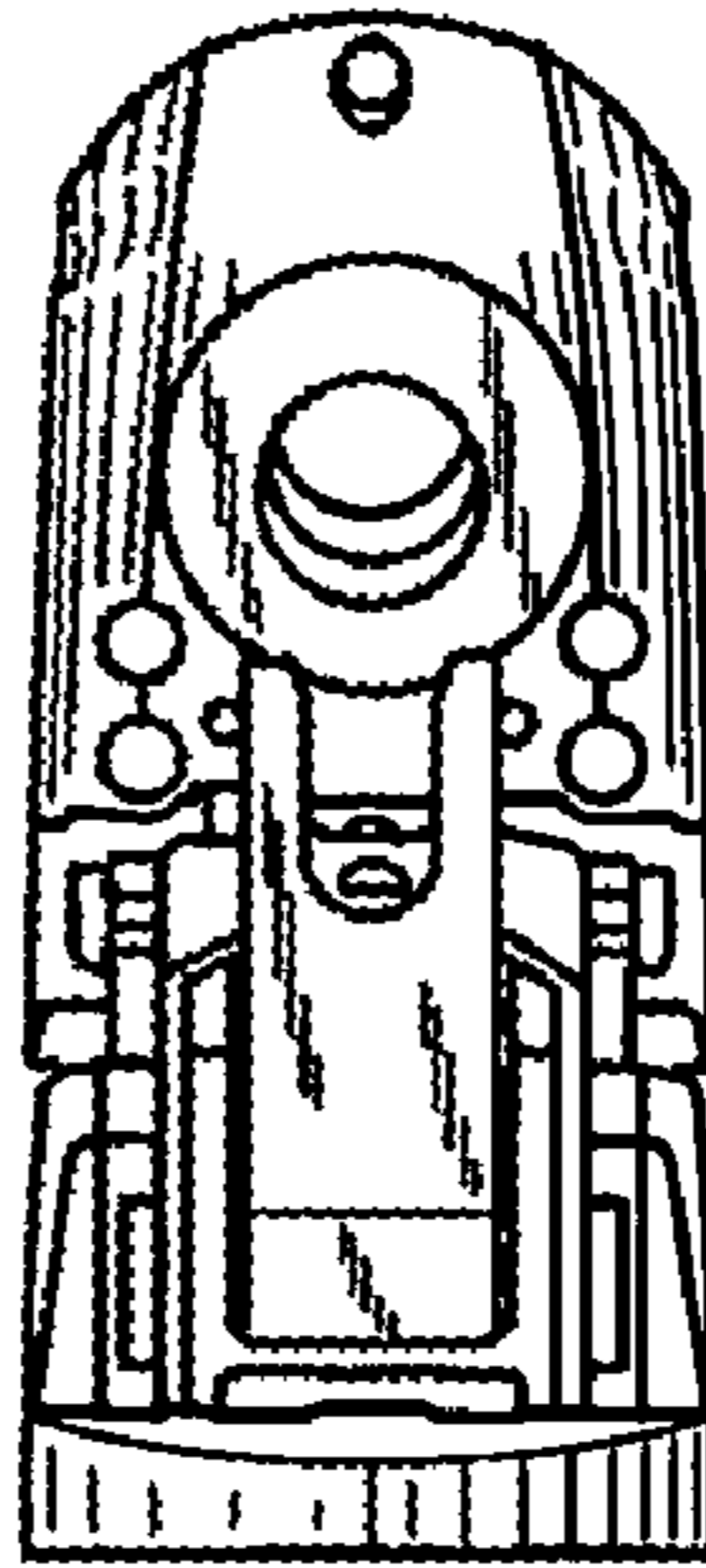

Fig. 4

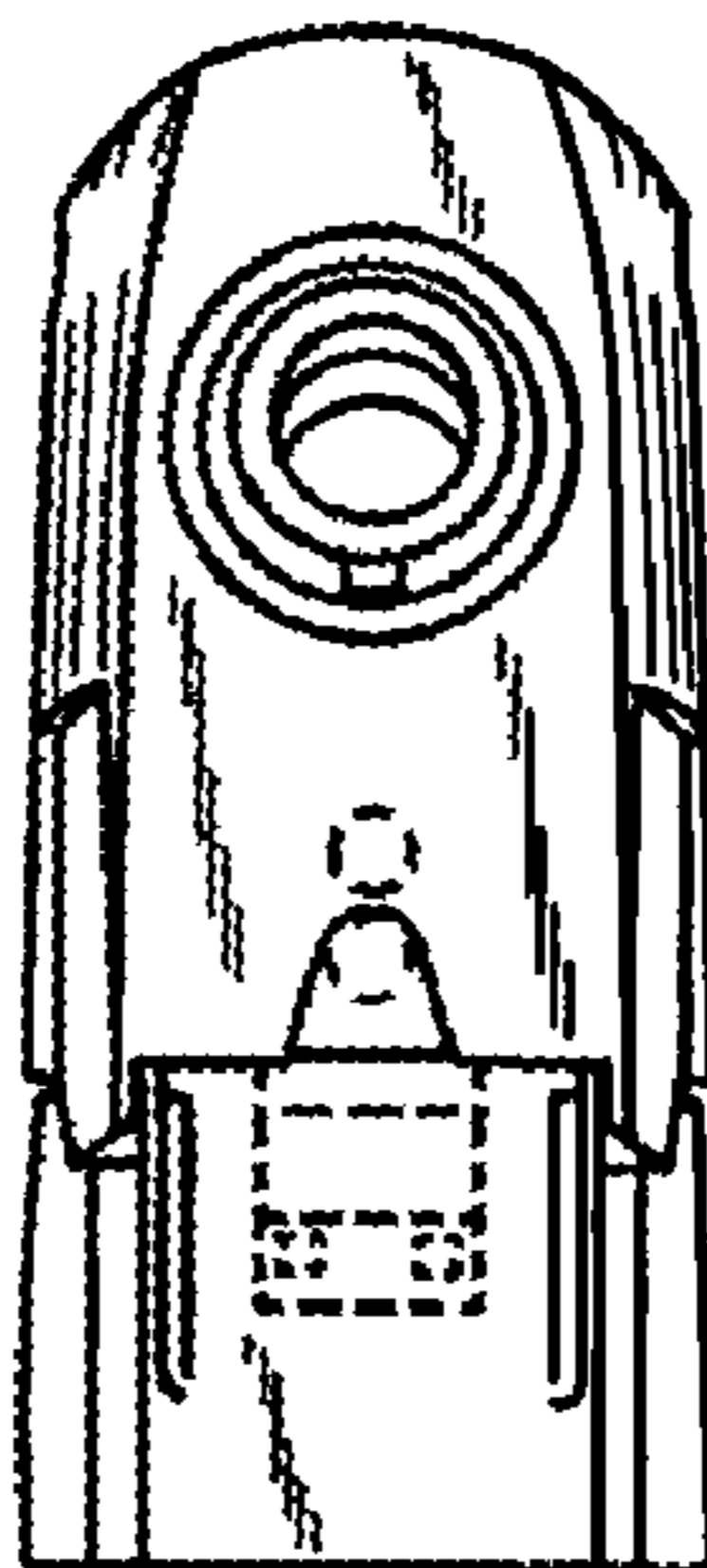

Fig. 5

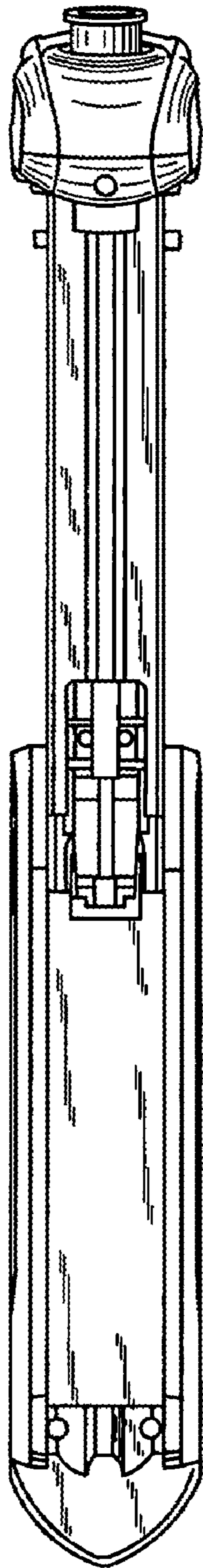

Fig. 6

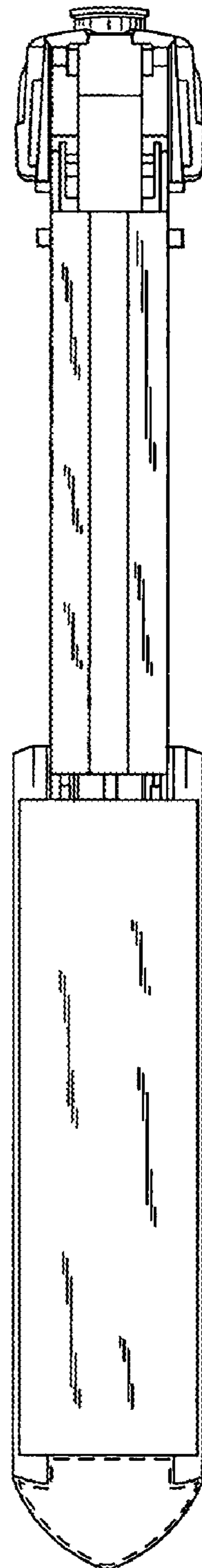

Fig. 7

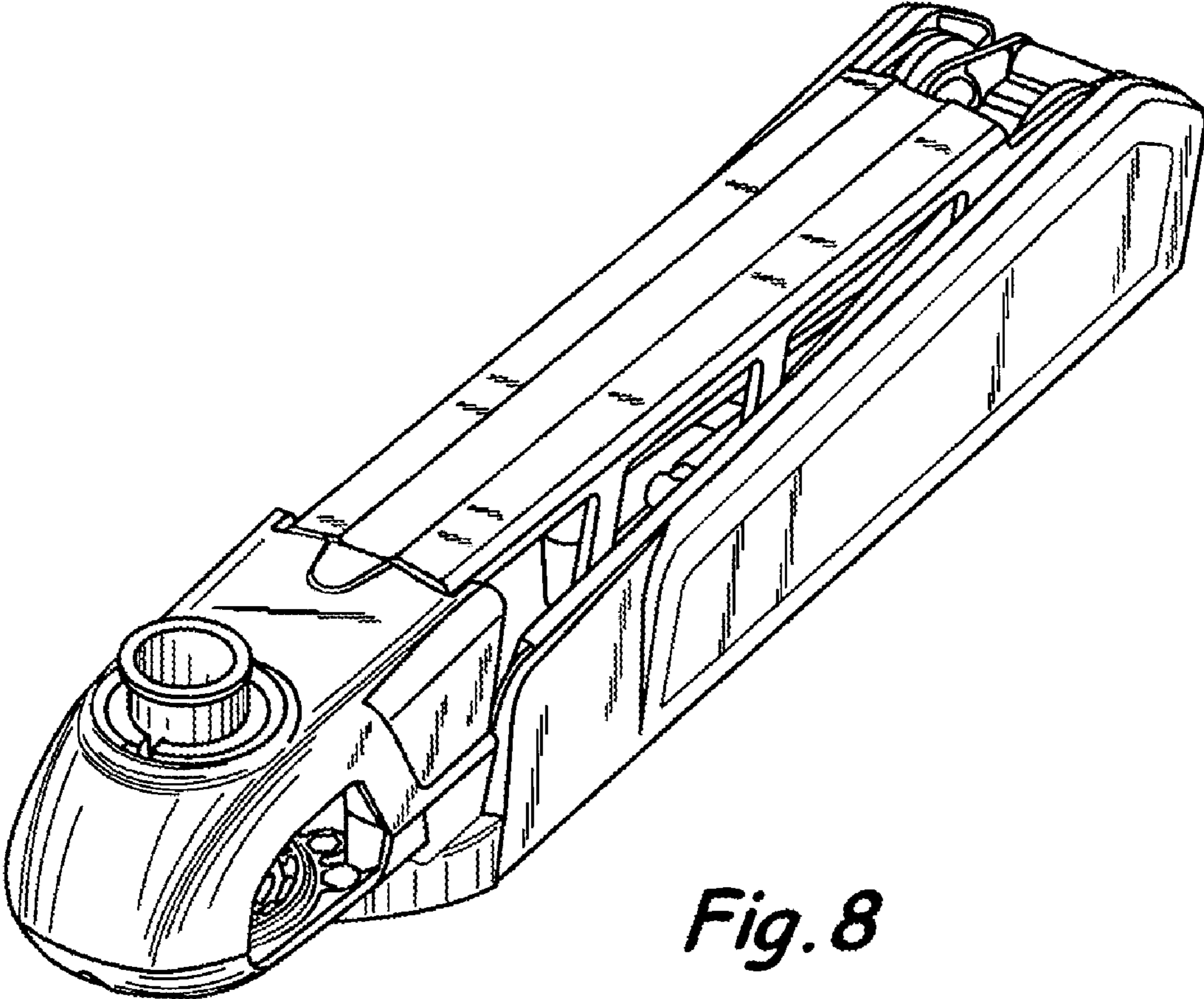

Fig. 8

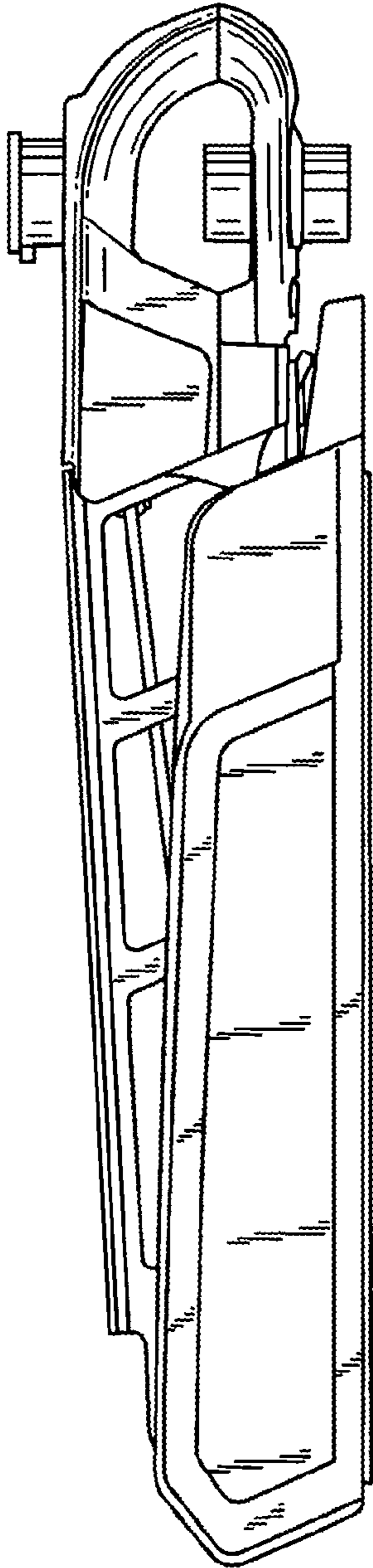

Fig. 9

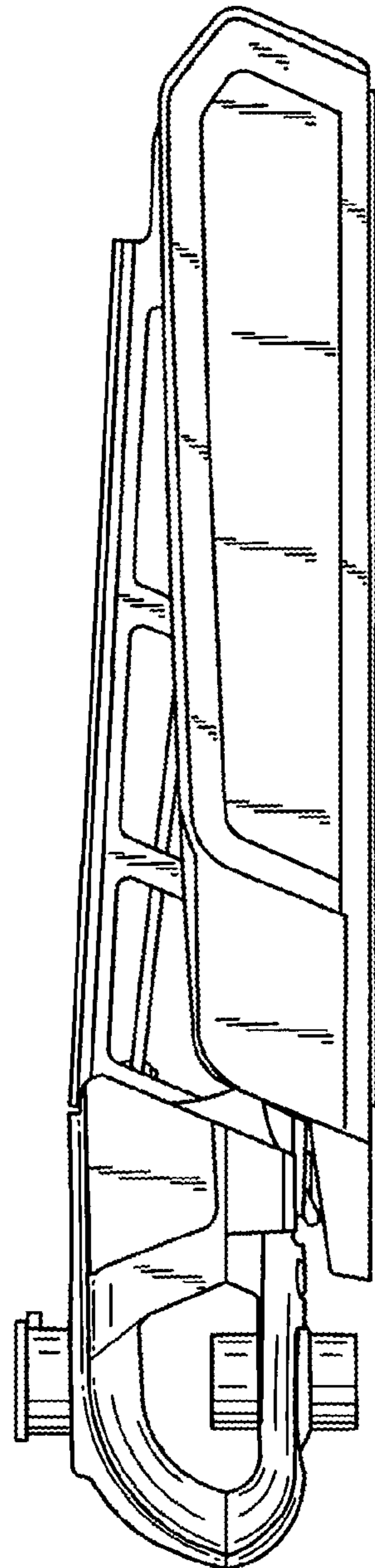

Fig. 10

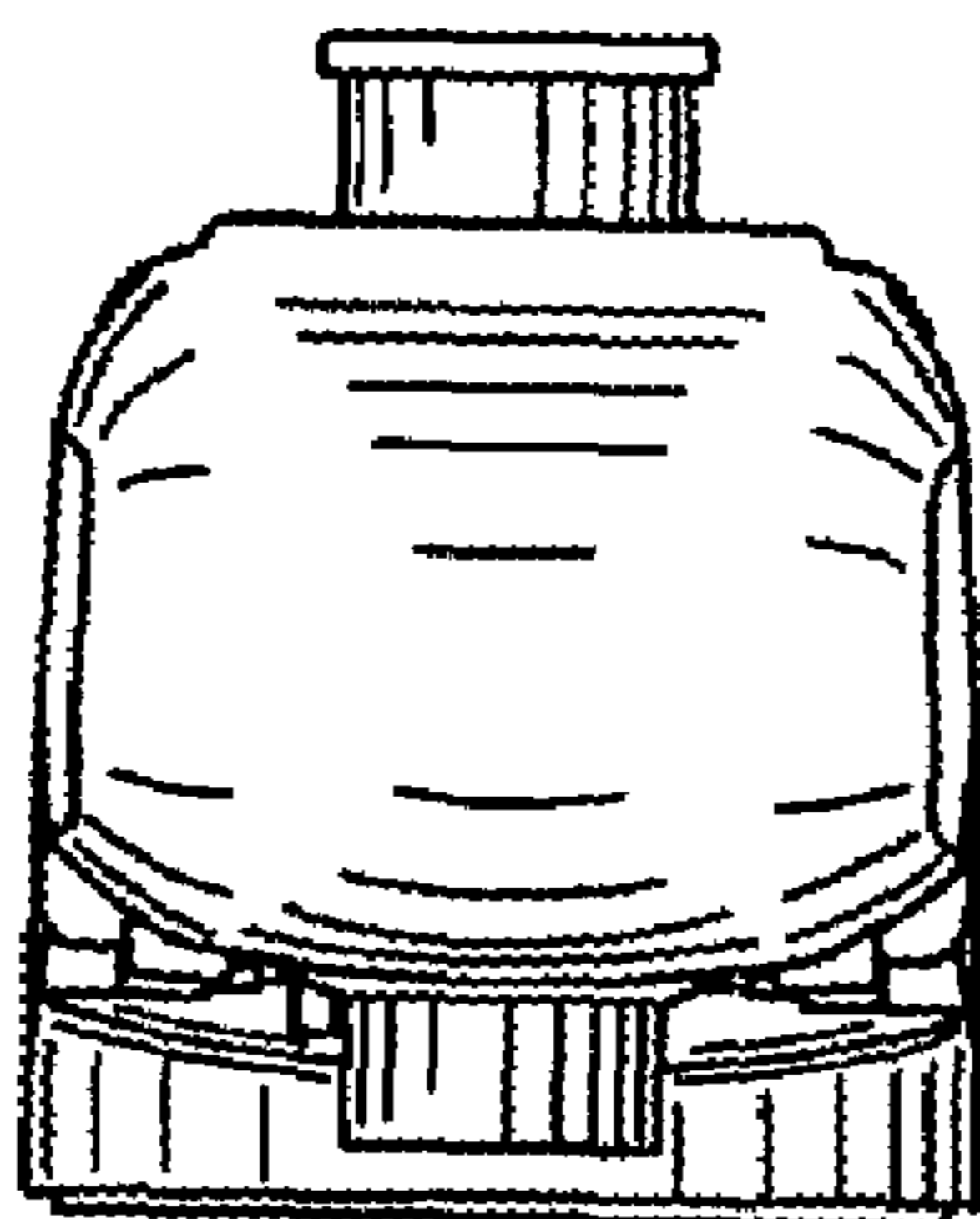

Fig. 11

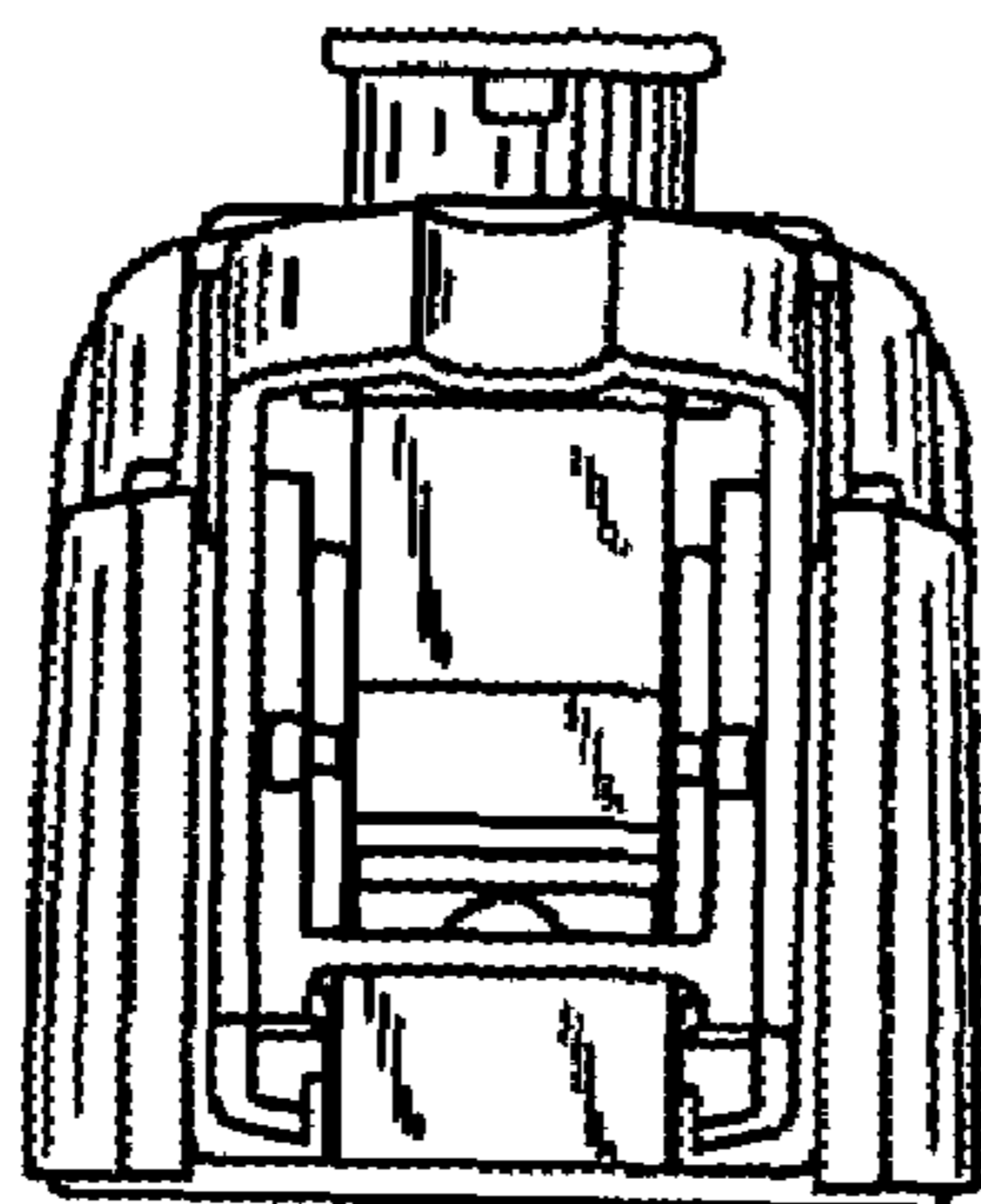

Fig. 12

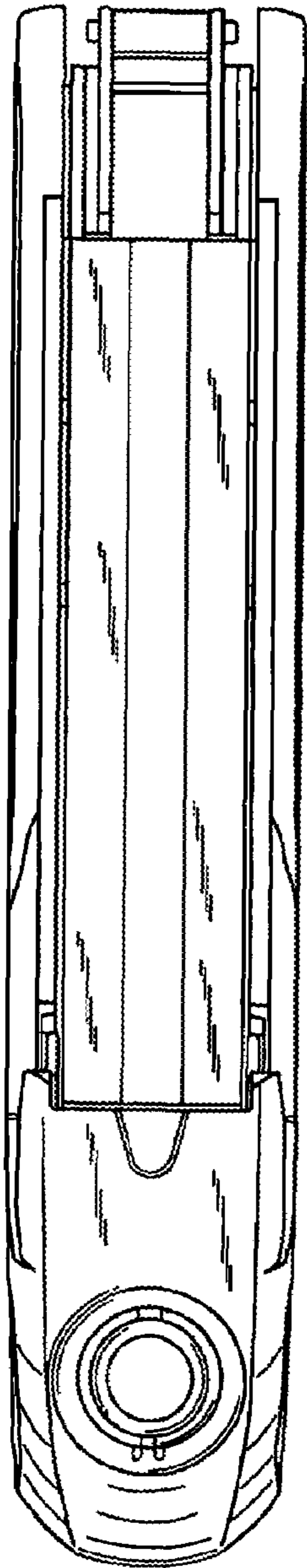

Fig. 13

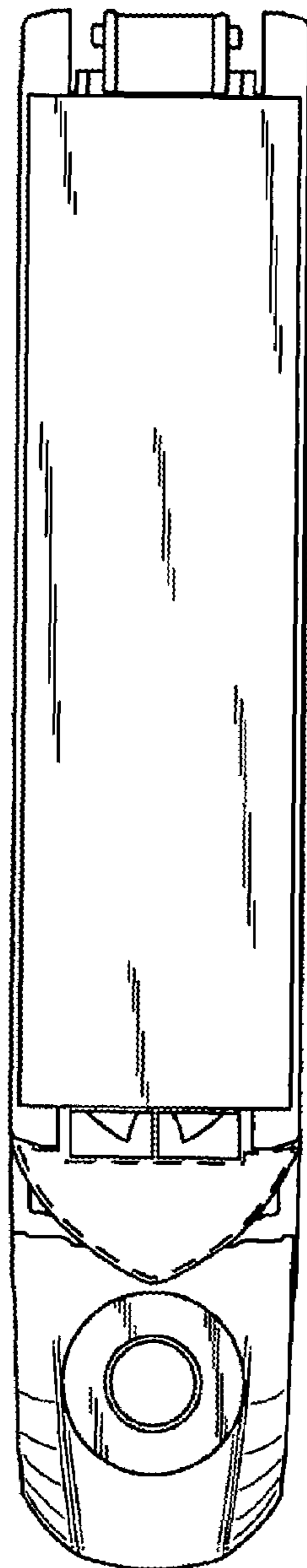

Fig. 14