



US00D593803S

(12) **United States Design Patent**
Olsson

(10) **Patent No.:** **US D593,803 S**
(45) **Date of Patent:** **** Jun. 9, 2009**

- (54) **TRAY**
- (75) Inventor: **Hakan Olsson**, Kullavik (SE)
- (73) Assignee: **Nobel Biocare Services AG**,
Zurich-Flughafen (CH)
- (**) Term: **14 Years**
- (21) Appl. No.: **29/269,635**
- (22) Filed: **Dec. 4, 2006**

- (30) **Foreign Application Priority Data**
Jun. 4, 2006 (EM) 000538921-0001/0007
- (51) **LOC (9) Cl.** **07-01**
- (52) **U.S. Cl.** **D7/550.1; D7/554.3; D7/558;**
D7/538
- (58) **Field of Classification Search** **D7/500,**
D7/552.2, 553.2, 550.1, 554.3, 629; D19/35;
D23/286; D24/177, 176, 229, 230, 277
See application file for complete search history.

- (56) **References Cited**
U.S. PATENT DOCUMENTS
3,563,370 A * 2/1971 Nozette et al. 220/788
D238,148 S * 12/1975 Dilot D7/629
D242,545 S * 11/1976 Perfect D24/230
D271,239 S * 11/1983 Lemieux et al. D24/230
D273,987 S * 5/1984 Holen et al. D24/223
D282,577 S * 2/1986 Neumeister D24/226
D288,484 S * 2/1987 Mitchell D24/230
D323,400 S * 1/1992 Frenkel et al. D24/230
D332,204 S * 1/1993 Carlson D7/629
D466,219 S * 11/2002 Wynschenk et al. D24/227
D509,411 S * 9/2005 Laib et al. D7/629

2008/0005923 A1* 1/2008 Zwingenberger et al. 34/411
* cited by examiner

Primary Examiner—Philip S Hyder
Assistant Examiner—Cynthia Underwood
(74) *Attorney, Agent, or Firm*—Knobbe, Martens, Olson & Bear, LLP

(57) **CLAIM**

The ornamental design for a tray, as shown and described herein.

DESCRIPTION

FIG. 1 is a top plan view of a tray embodying a new design; FIG. 2 is a right side elevational view thereof; FIG. 3 is a front elevational view thereof; FIG. 4 is a front, top, and left side perspective view thereof; FIG. 5 is a bottom plan view thereof; FIG. 6 is a rear, top, and right side perspective view thereof; FIG. 7 is a rear, bottom, and left side perspective view thereof; FIG. 8 is a left side elevational view of the tray in FIGS. 1–7 supported in a tilted configuration; FIG. 9 is a rear, bottom, and left side perspective view thereof; FIG. 10 is a front, bottom, and right side perspective view thereof; FIG. 11 is a front, top, and left side perspective view thereof; FIG. 12 is a rear, top, and right side perspective view thereof; and, FIG. 13 is a front, top, and left side perspective view of the tray of FIGS. 1–12 with a top cover in an open position. The broken lines which define the bounds of the claimed design form no part thereof.

1 Claim, 13 Drawing Sheets

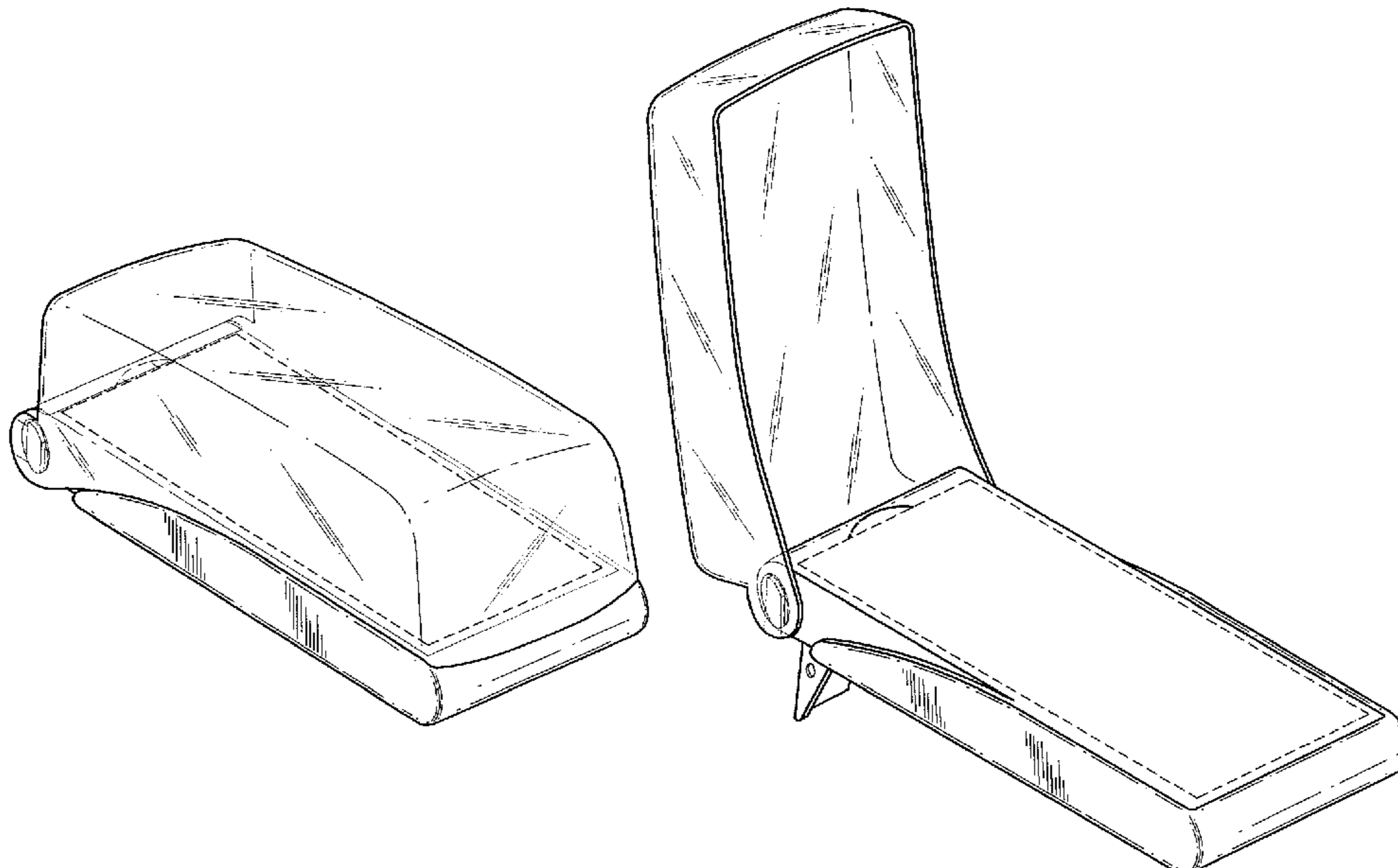

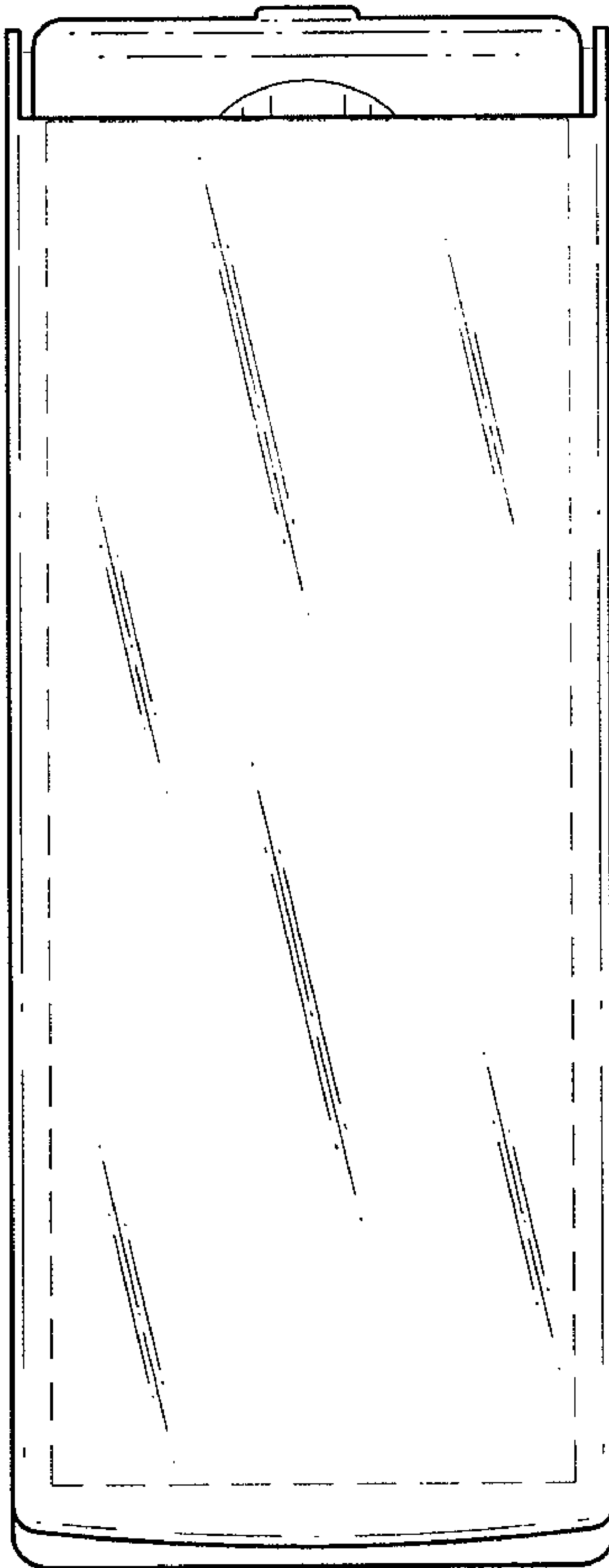

FIG. 1

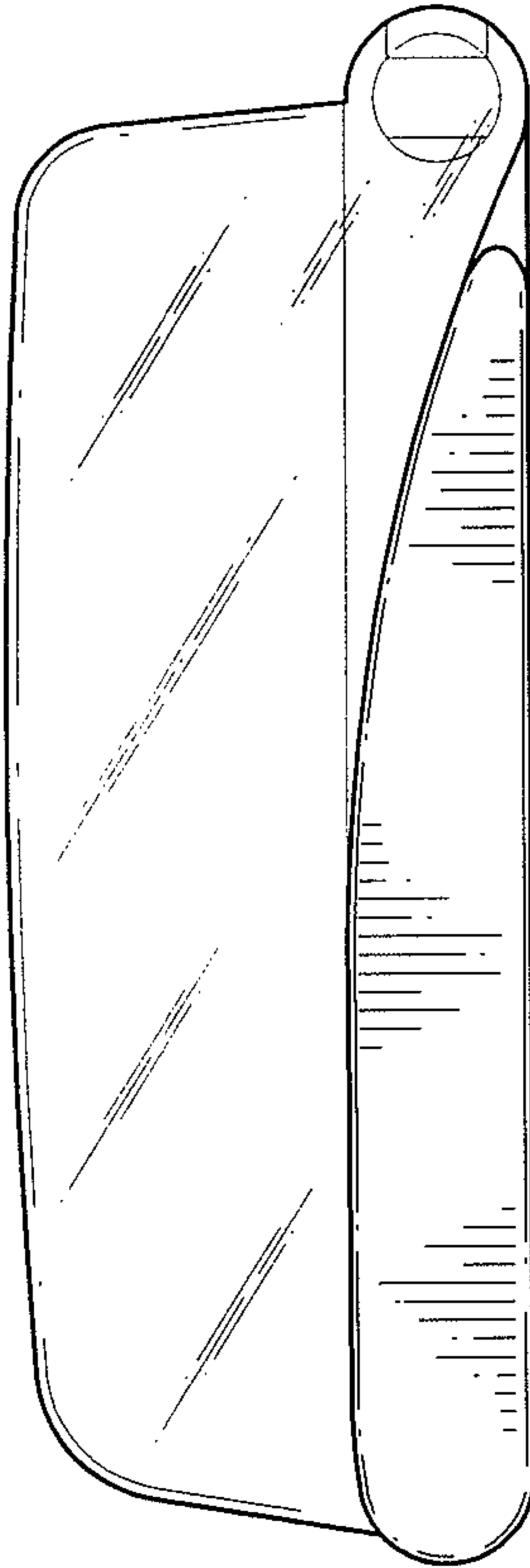

FIG. 2

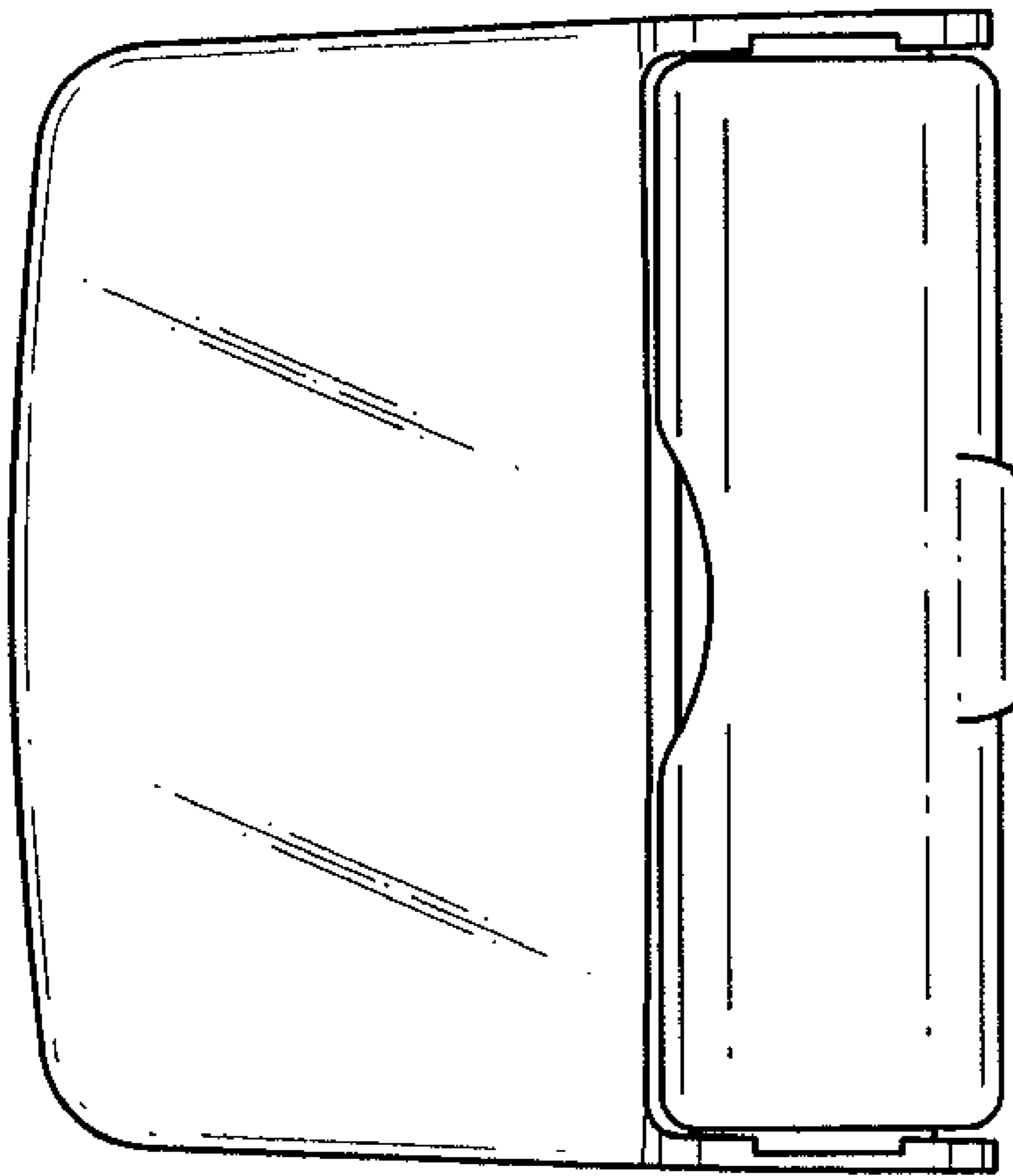

FIG. 3

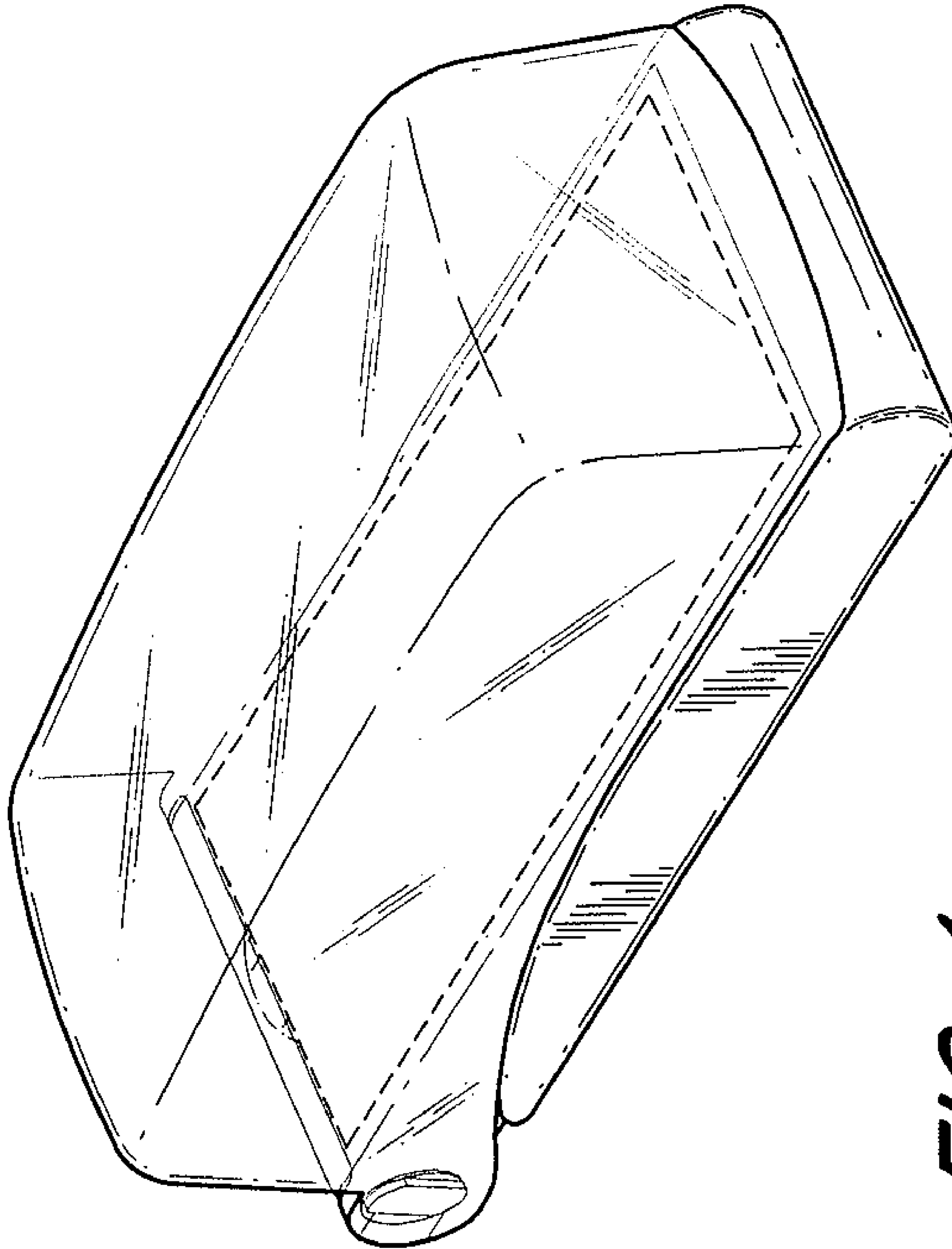

FIG. 4

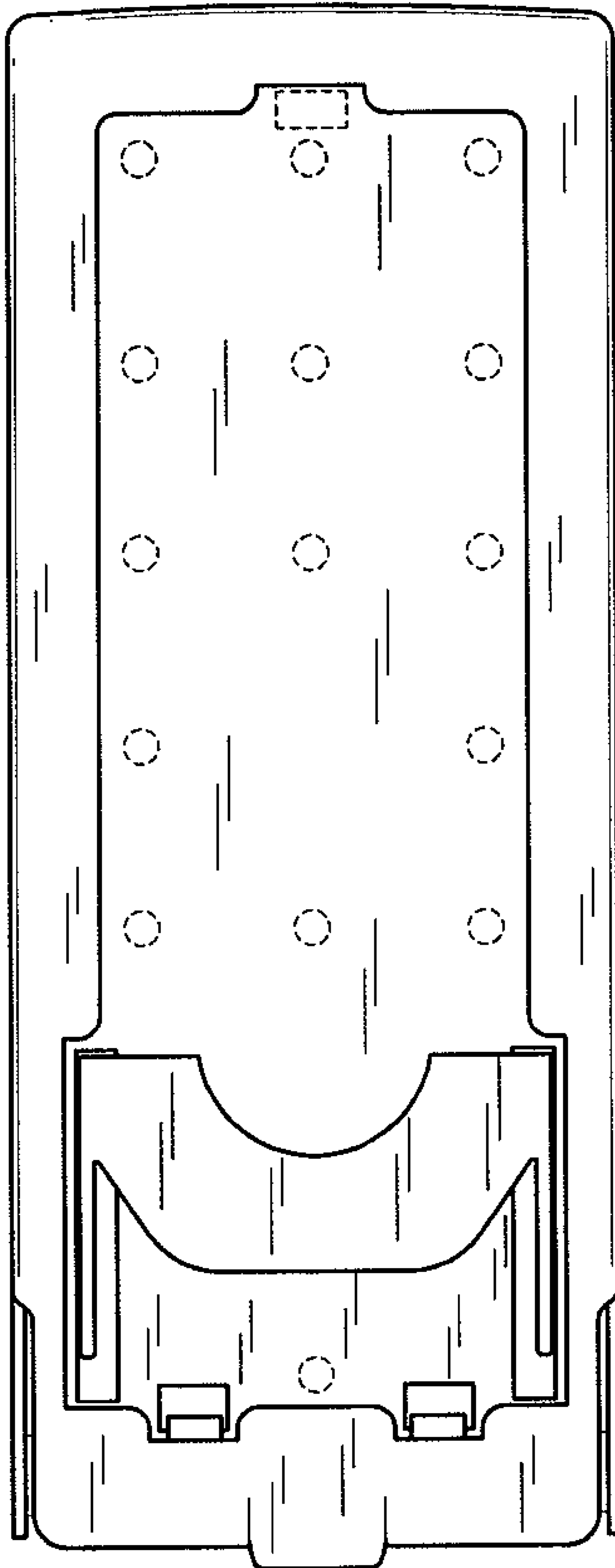

FIG. 5

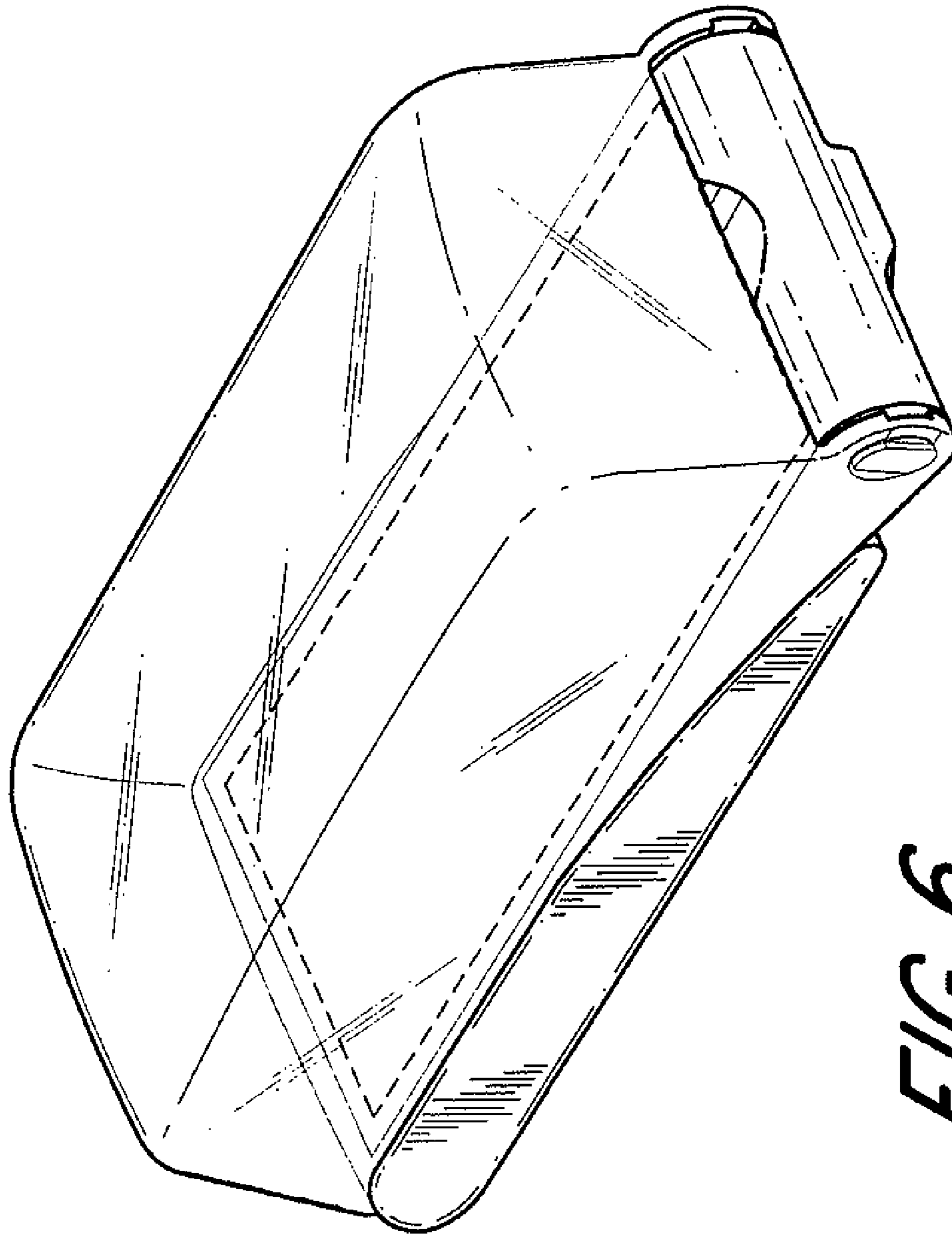

FIG. 6

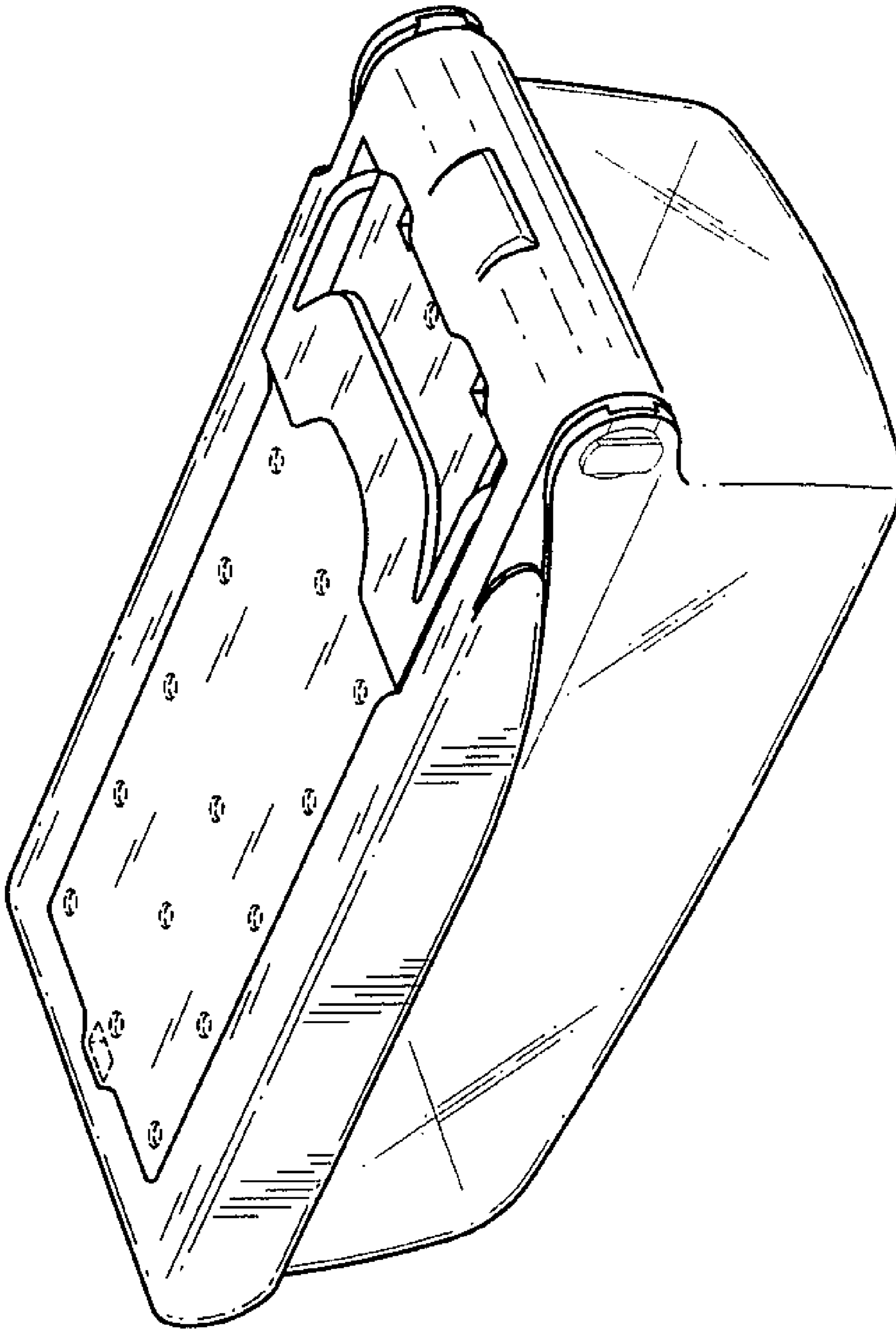

FIG. 7

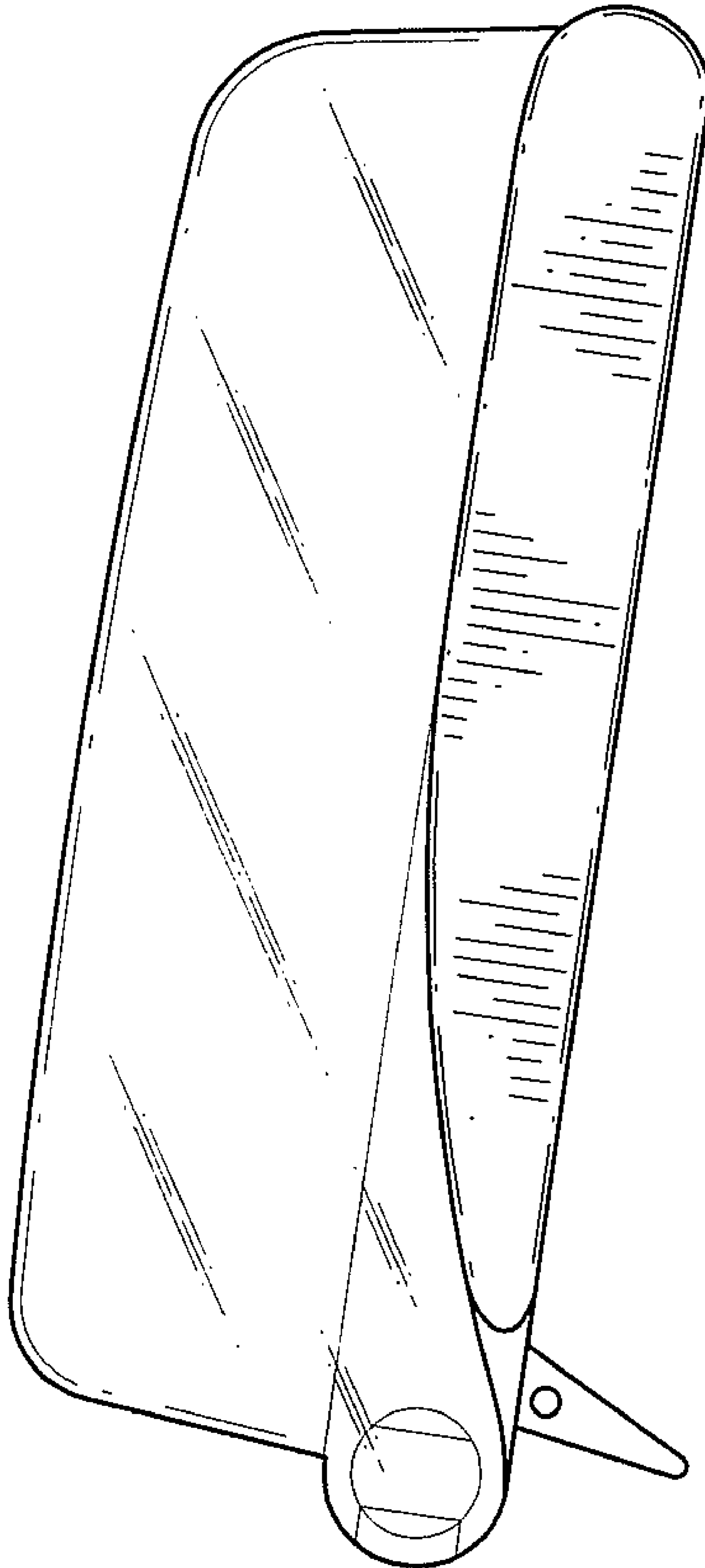

FIG. 8

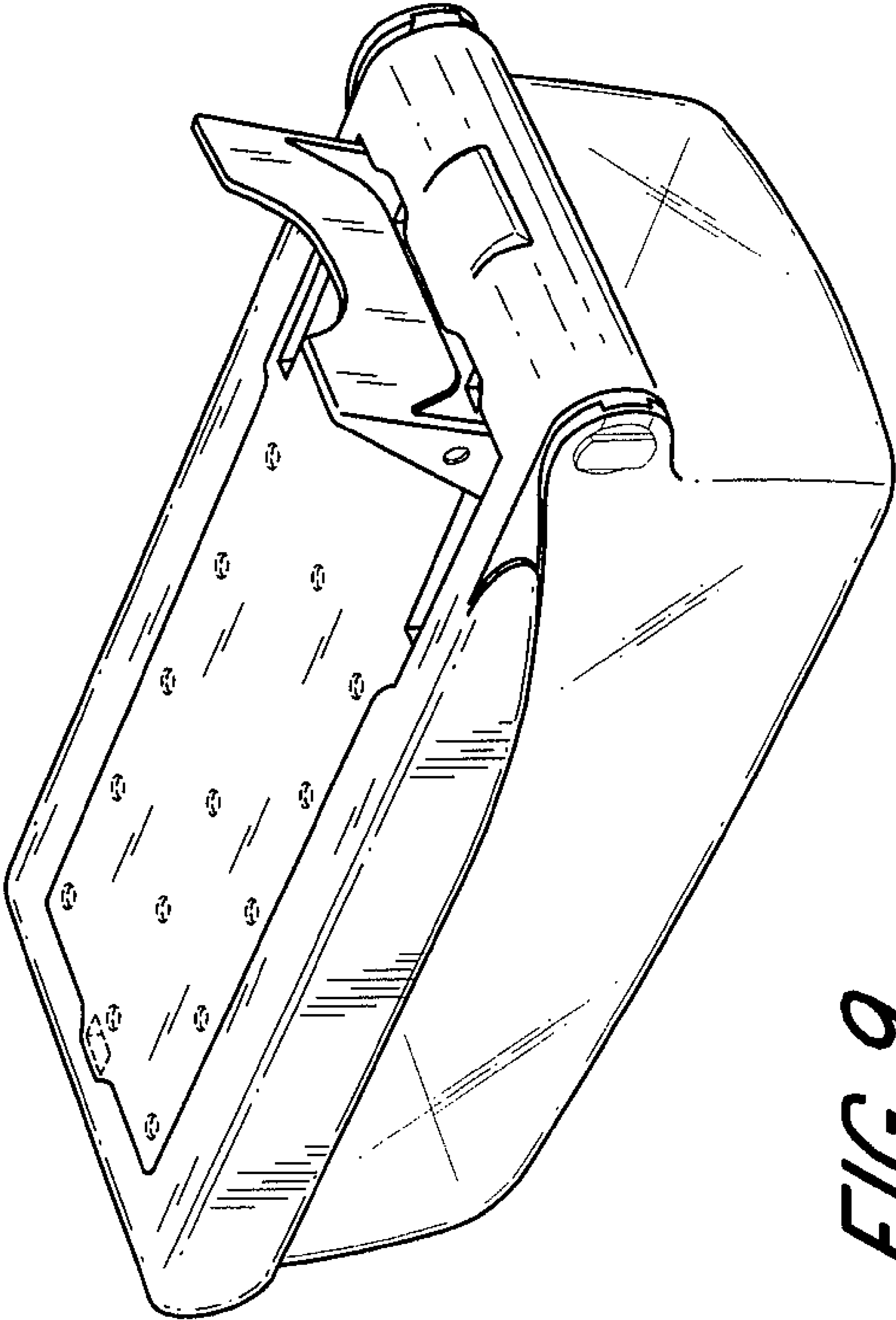

FIG. 9

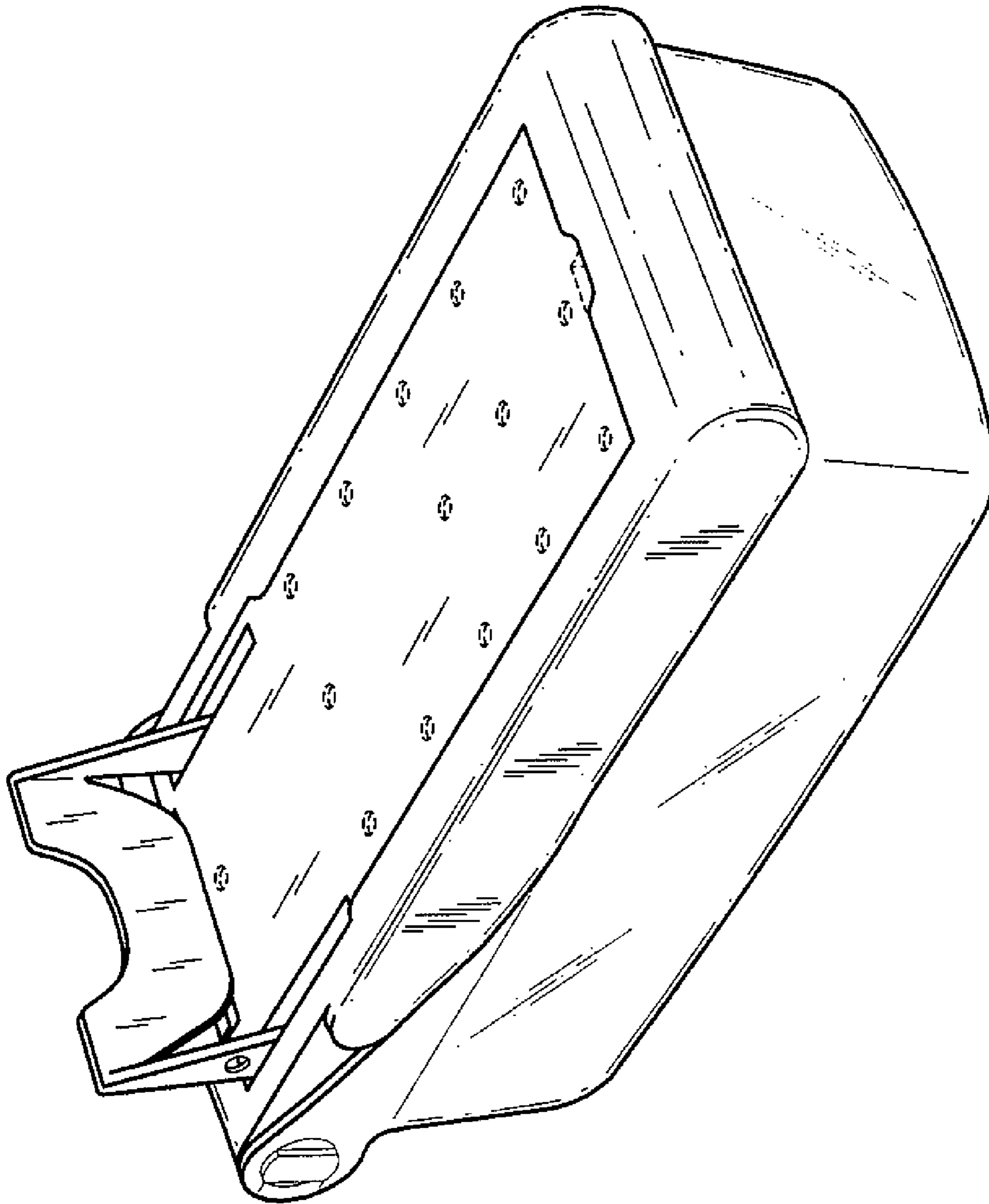

FIG. 10

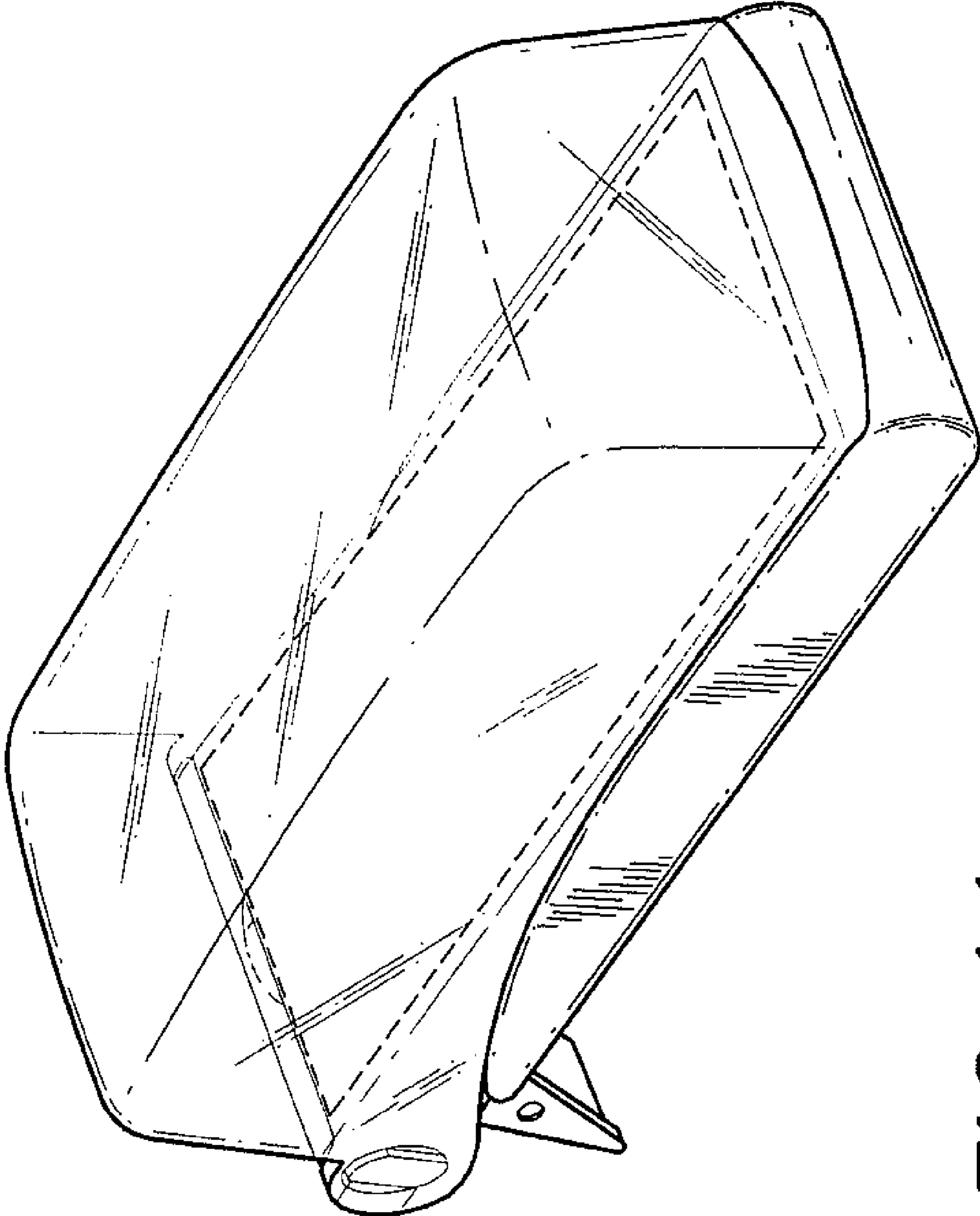

FIG. 11

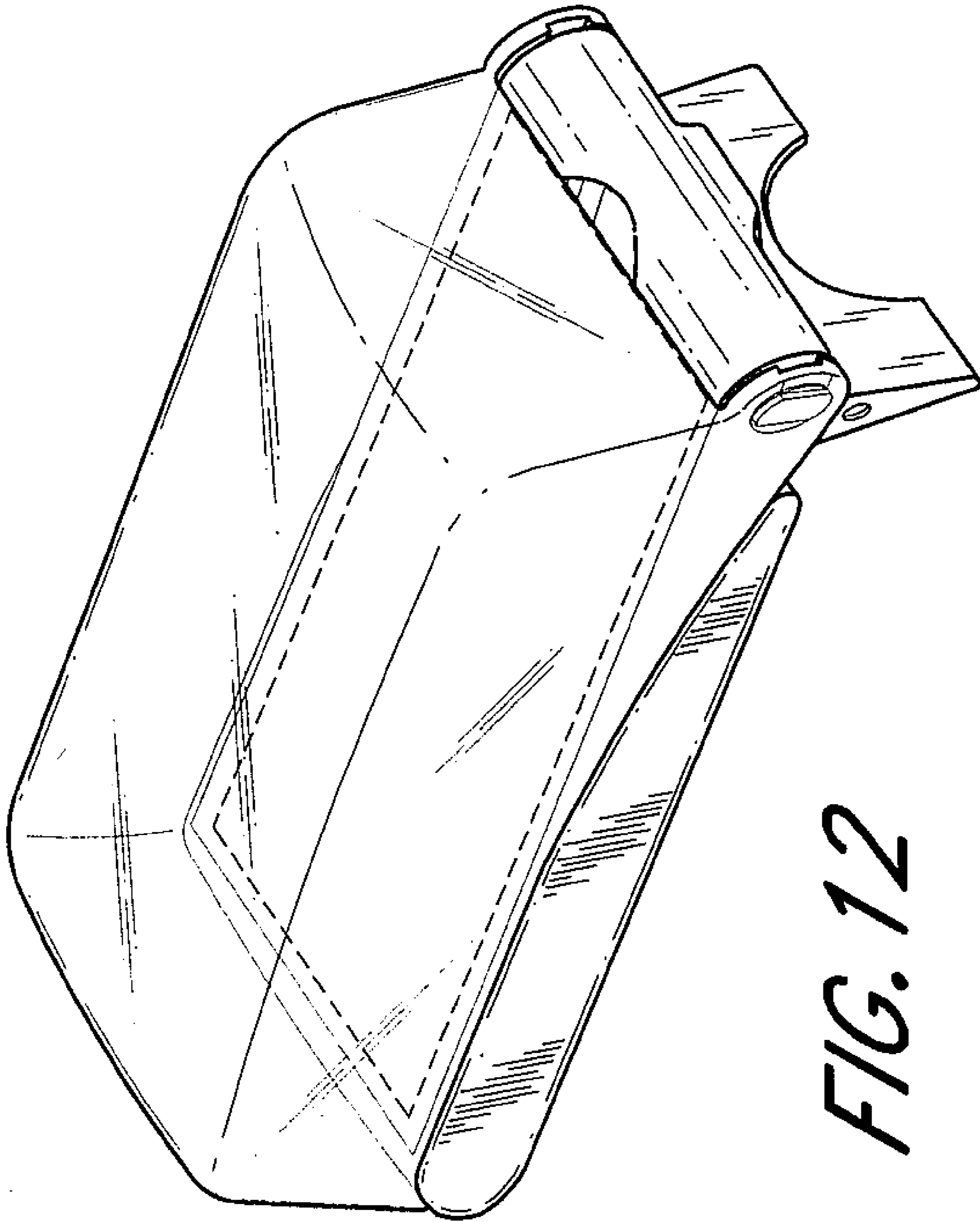

FIG. 13

