



US00D593796S

(12) **United States Design Patent**
Kevan

(10) **Patent No.:** **US D593,796 S**
(45) **Date of Patent:** **** Jun. 9, 2009**

(54) **CONTAINER FOR HOLDING A FLEXIBLE COFFEE BAG**

2007/0187558 A1 8/2007 Blodgett et al.

FOREIGN PATENT DOCUMENTS

(75) Inventor: **Sherrene Kevan**, Cambridge (CA)

JP 5294368 11/1993

(73) Assignee: **Enviroquest, Ltd.** (CA)

* cited by examiner

(**) Term: **14 Years**

Primary Examiner—Robert M. Spear
Assistant Examiner—Cynthia Underwood

(21) Appl. No.: **29/321,558**

(74) *Attorney, Agent, or Firm*—Dinsmore & Shohl LLP

(22) Filed: **Jul. 18, 2008**

(57) **CLAIM**

(51) **LOC (9) Cl.** **07-01**

The ornamental design for a container for holding a flexible coffee bag, as shown and described.

(52) **U.S. Cl.** **D7/400; D34/1**

(58) **Field of Classification Search** D7/400,
D7/399, 397, 387, 647, 667, 602, 653, 523,
D7/509, 619.1, 601; D9/455, 428, 502, 500;
D23/209; D6/476, 468; D34/1; 99/501–513,
99/495, 403, 426; 100/113, 116, 213; 210/464–478,
210/498, 499, 800, 497.01, 497.3, 348, 232;
220/676, 62, 675, DIG. 1; 229/400

See application file for complete search history.

DESCRIPTION

(56) **References Cited**

U.S. PATENT DOCUMENTS

1,760,131 A	5/1930	Gibson	
2,040,241 A *	5/1936	Cortilet	206/756
2,979,225 A *	4/1961	Noffsinger	220/742
3,280,698 A	10/1966	Craine	
D251,352 S	3/1979	Menius	
4,495,404 A	1/1985	Carmichael	
D304,872 S *	11/1989	Jebb	D34/1
4,962,973 A *	10/1990	Allmon	312/325
D329,154 S *	9/1992	Waterston	D6/476
5,325,978 A	7/1994	Rabig	
6,015,063 A *	1/2000	Poliquin	220/495.04
D421,168 S *	2/2000	France	D34/1
D447,417 S	9/2001	Filho	
D470,912 S *	2/2003	Daws et al.	D23/209
D493,590 S *	7/2004	Chen	D34/1
D562,557 S *	2/2008	Lewis	D3/313
D568,102 S *	5/2008	Ruiz de Az a	D7/505
D578,355 S *	10/2008	Arney	D7/601

FIG. 1 is a perspective view of a container for holding a flexible coffee bag illustrating my new design;

FIG. 2 is a front elevational view of the design of FIG. 1;

FIG. 3 is a back elevational view of the design of FIG. 1;

FIG. 4 is a left side elevational view of the design of FIG. 1;

FIG. 5 is a right side elevational view of the design of FIG. 1;

FIG. 6 is a top plan view of the design of FIG. 1;

FIG. 7 is a bottom plan view of the design of FIG. 1;

FIG. 8 is a perspective view of an alternative embodiment of a container for holding a flexible coffee bag illustrating my new design;

FIG. 9 is a front elevational view of the design of FIG. 8;

FIG. 10 is a back elevational view of the design of FIG. 8;

FIG. 11 is a left side elevational view of the design of FIG. 8;

FIG. 12 is a right side elevational view of the design of FIG. 8;

FIG. 13 is a top plan view of the design of FIG. 8; and,

FIG. 14 is a bottom plan view of the design of FIG. 8.

The broken lines represent portions of the structure that form no part of the claim.

1 Claim, 12 Drawing Sheets

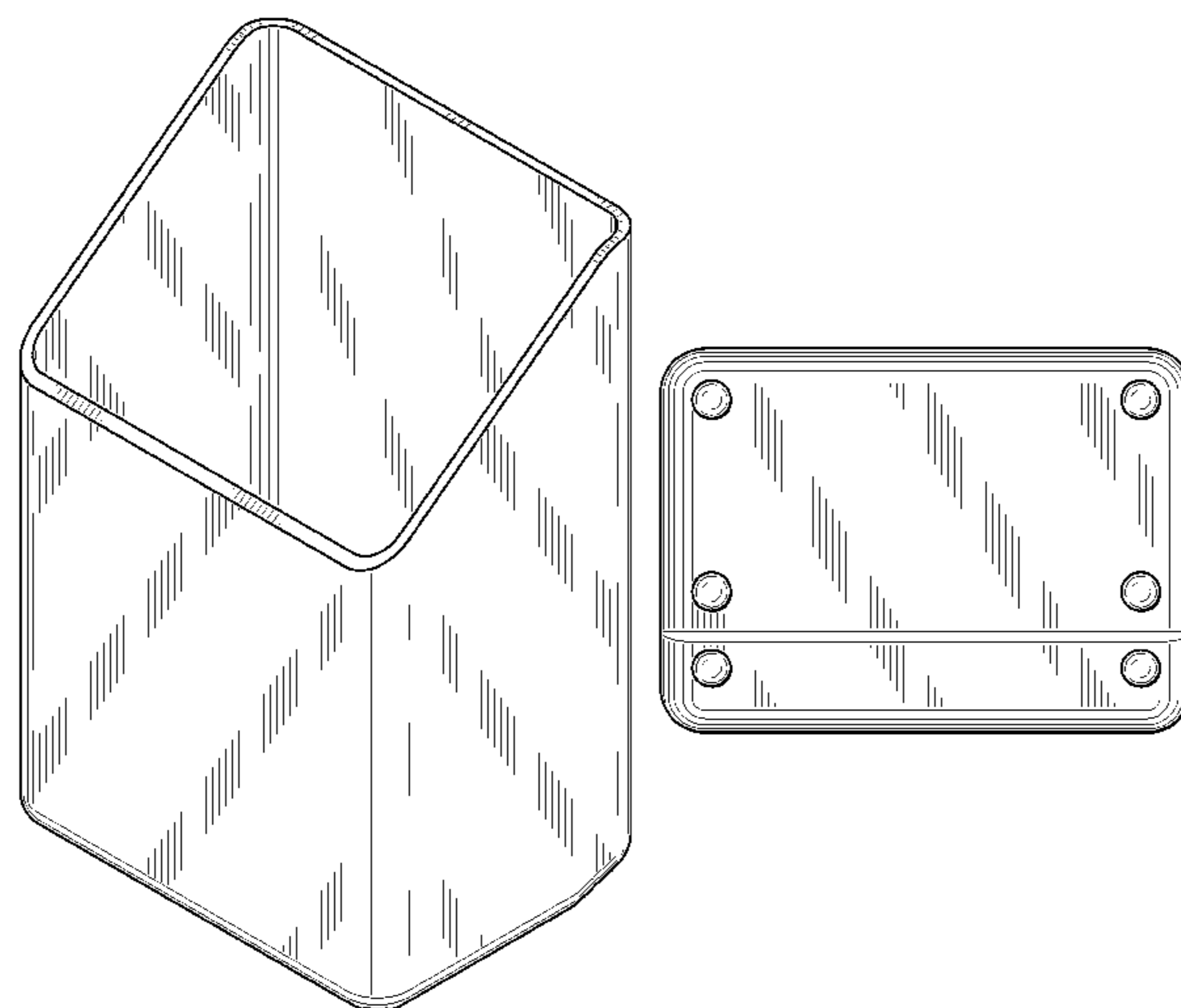

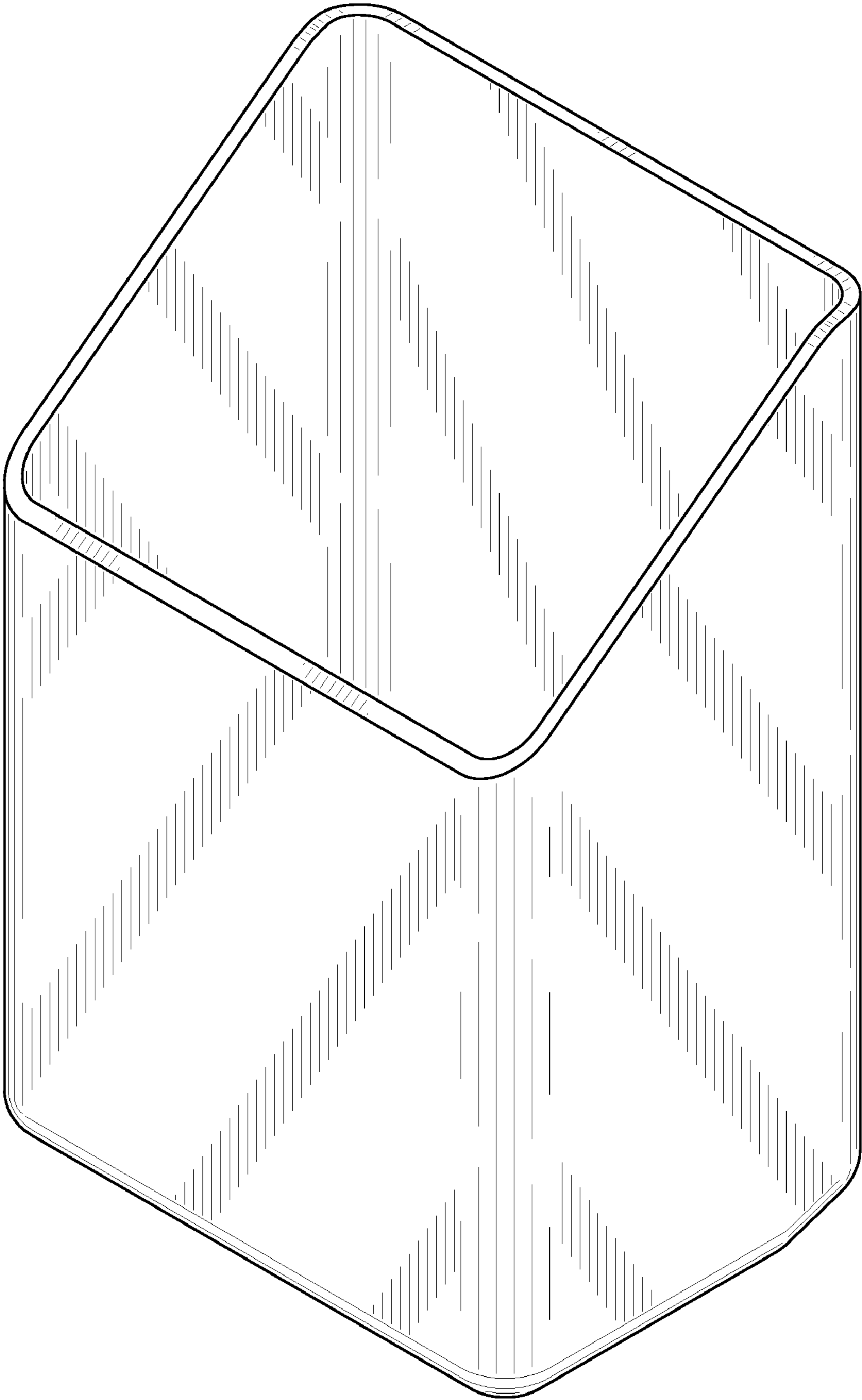

FIG. 1

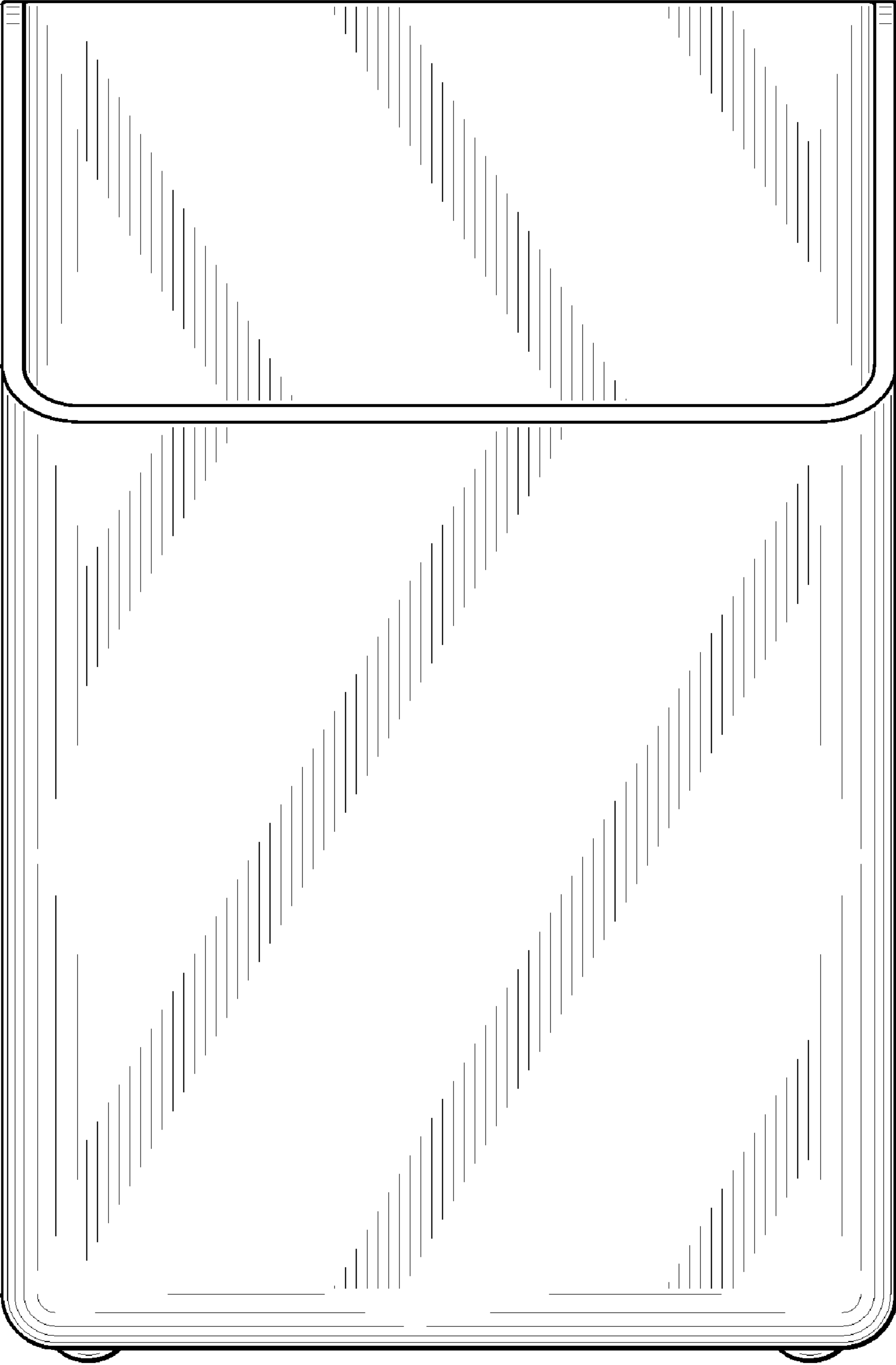

FIG. 2

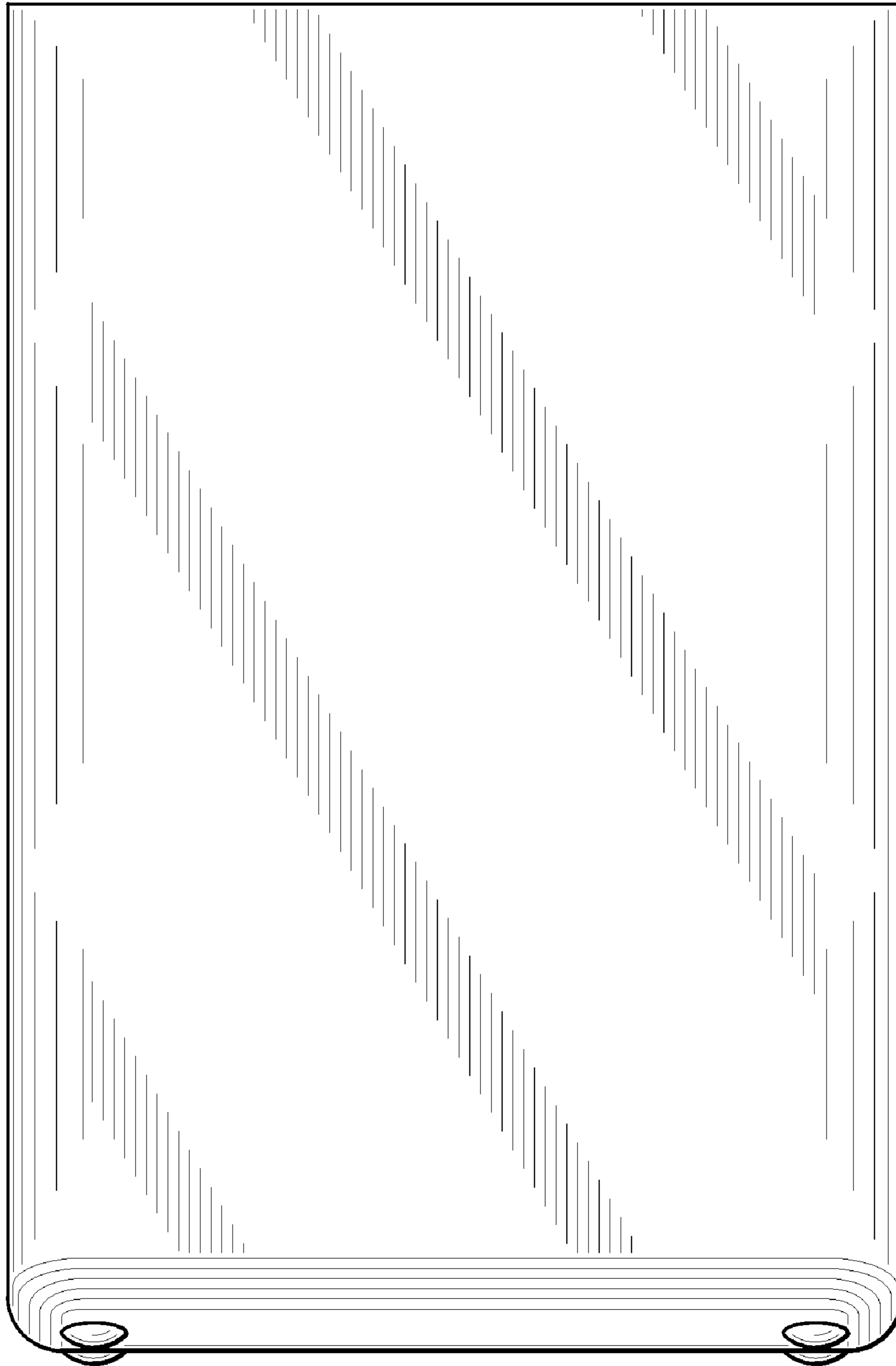

FIG. 3

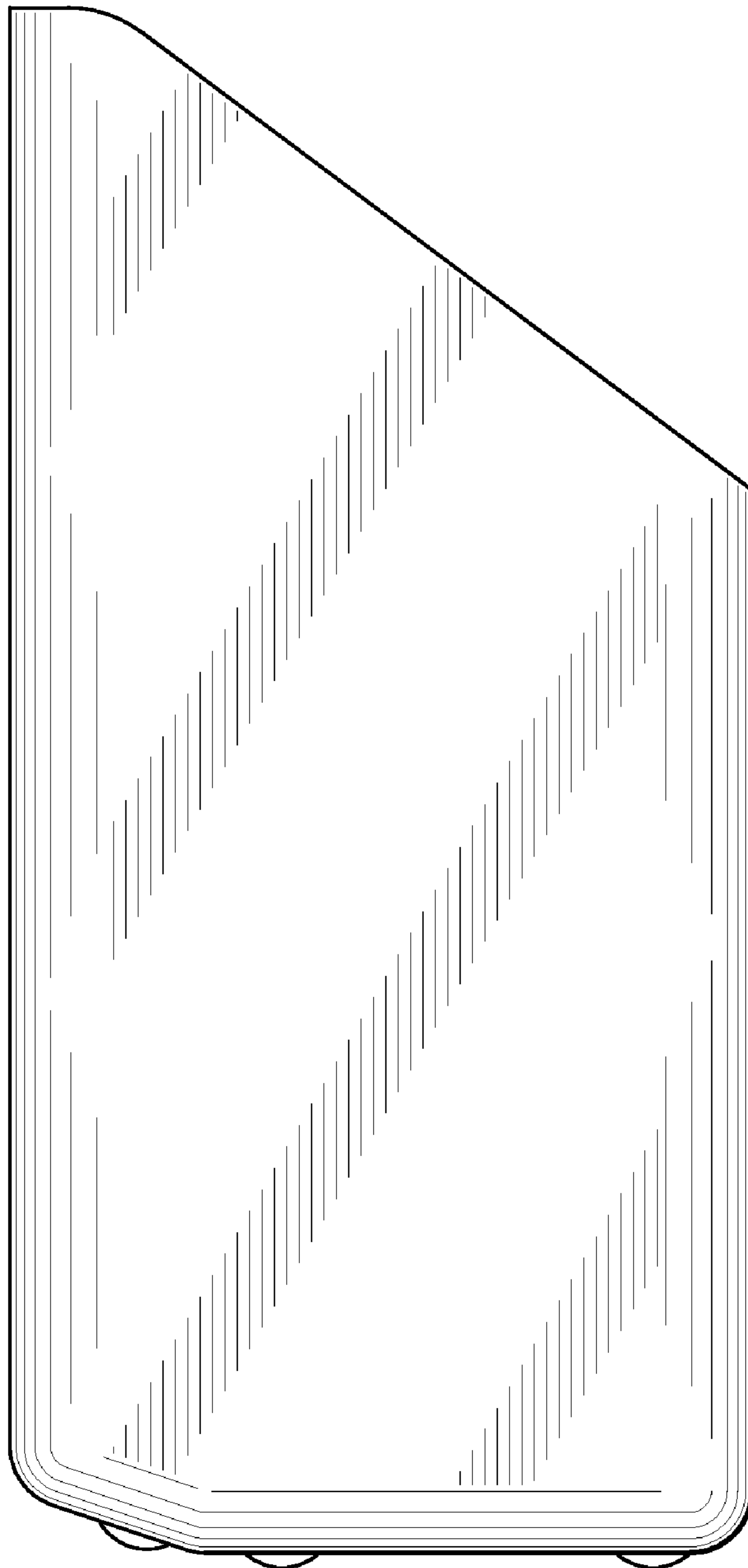

FIG. 4

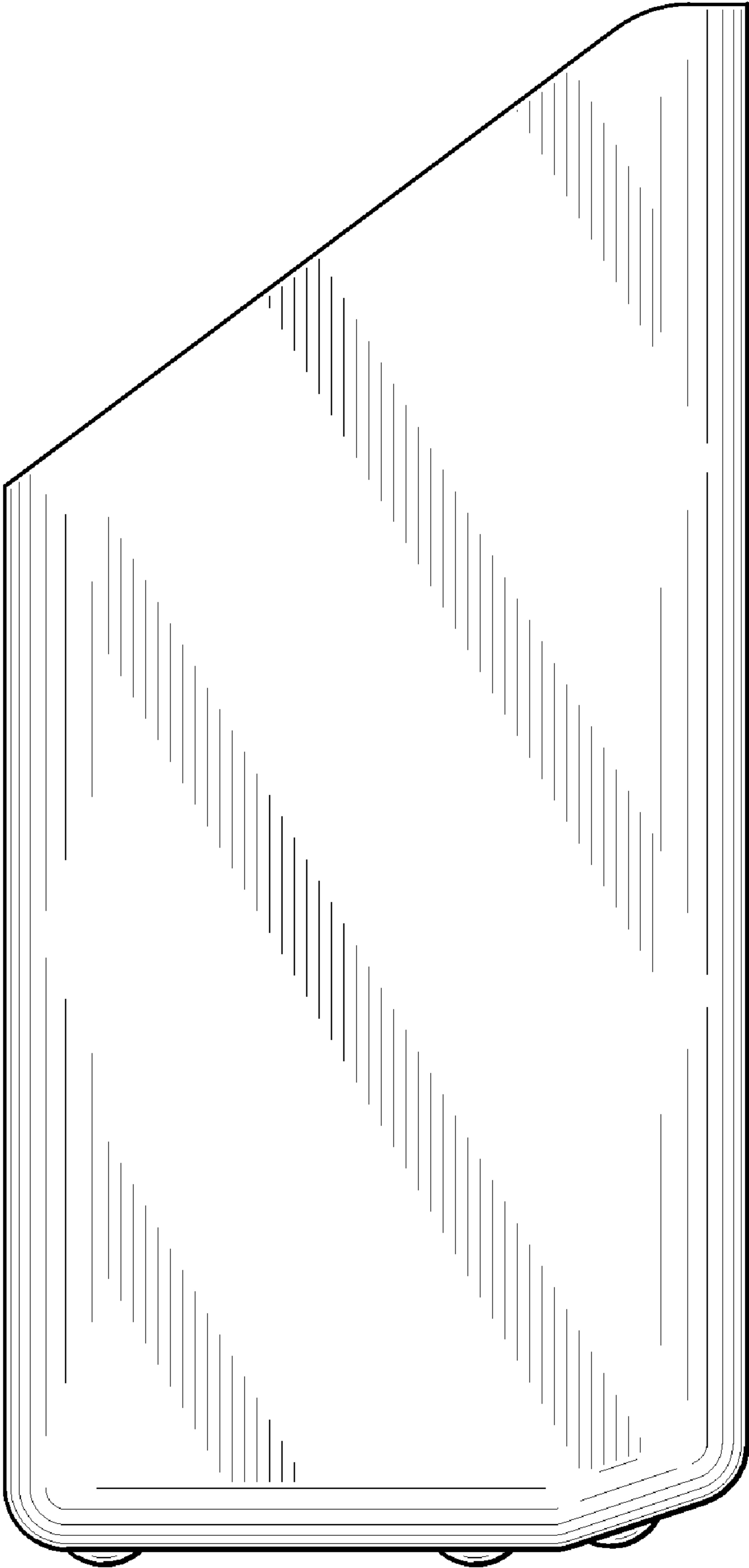

FIG. 5

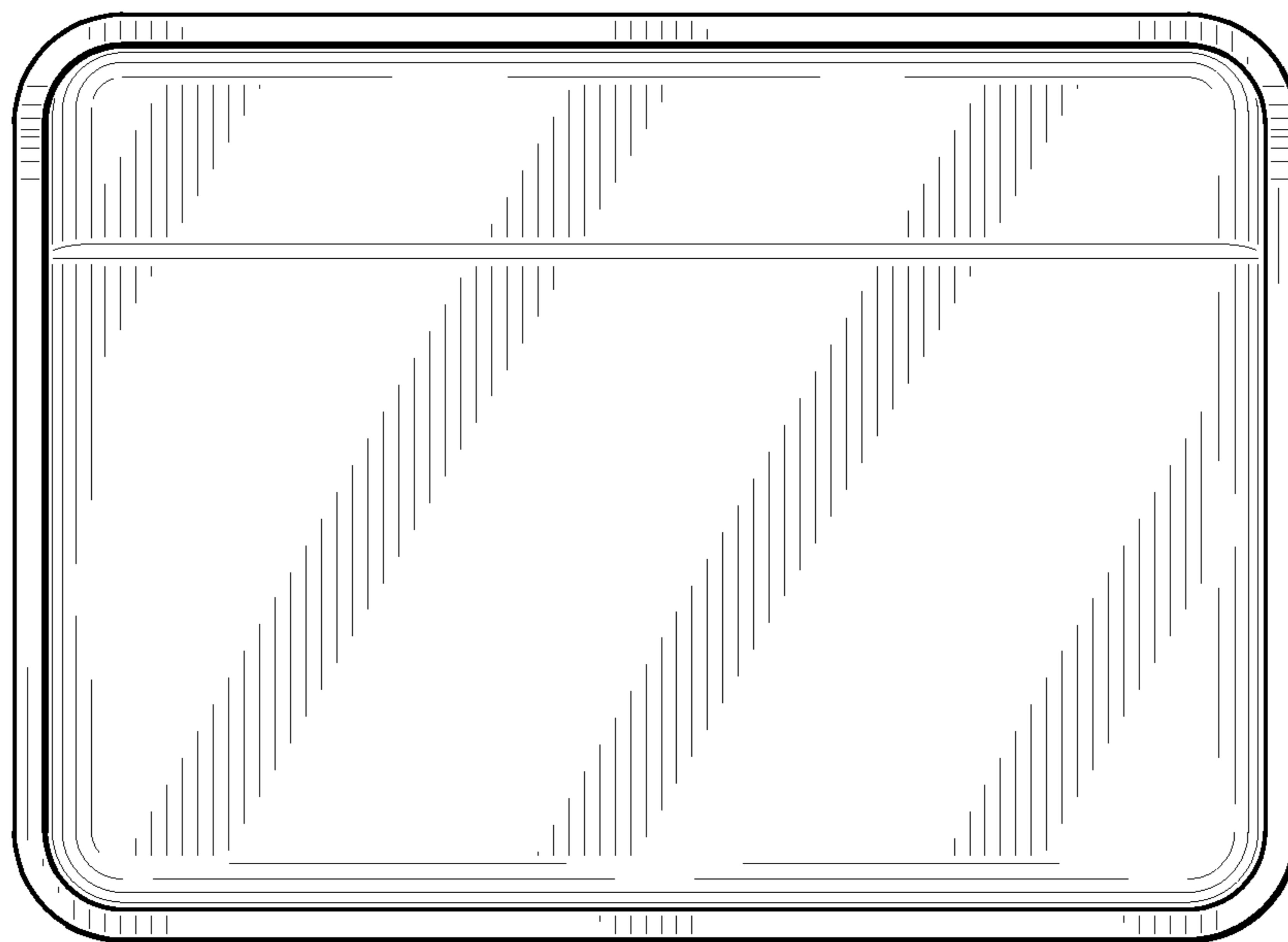

FIG. 6

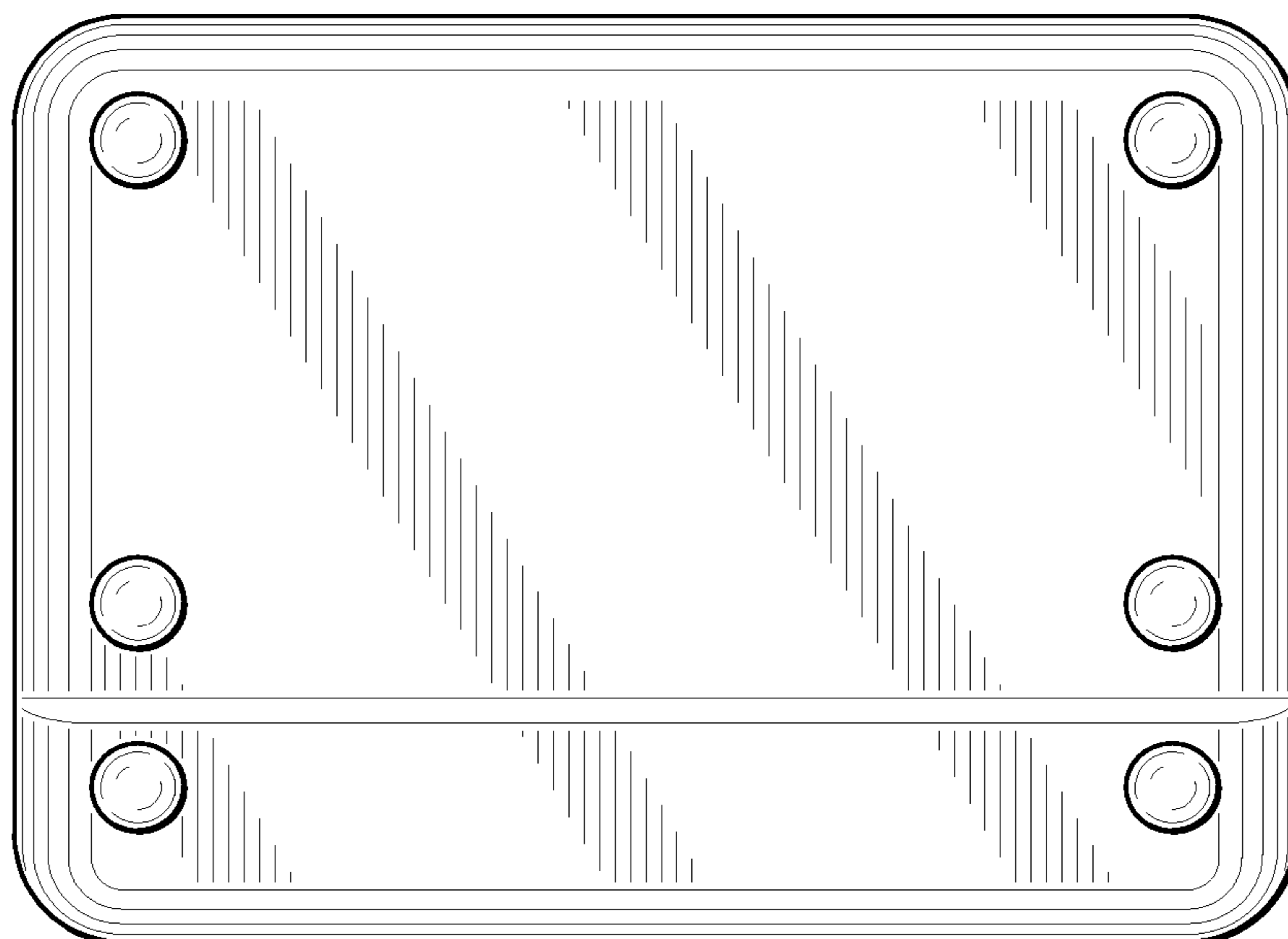

FIG. 7

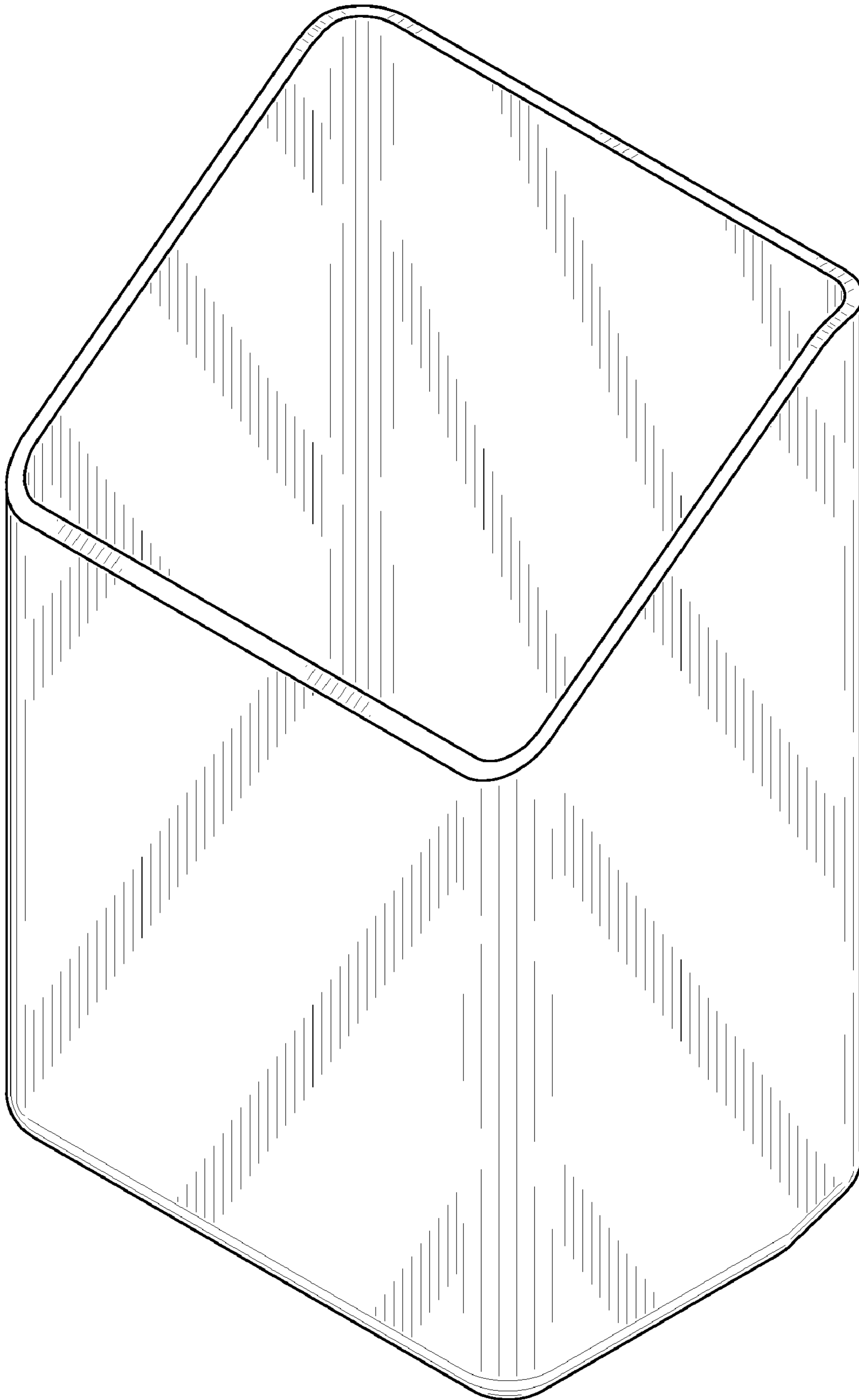

FIG. 8

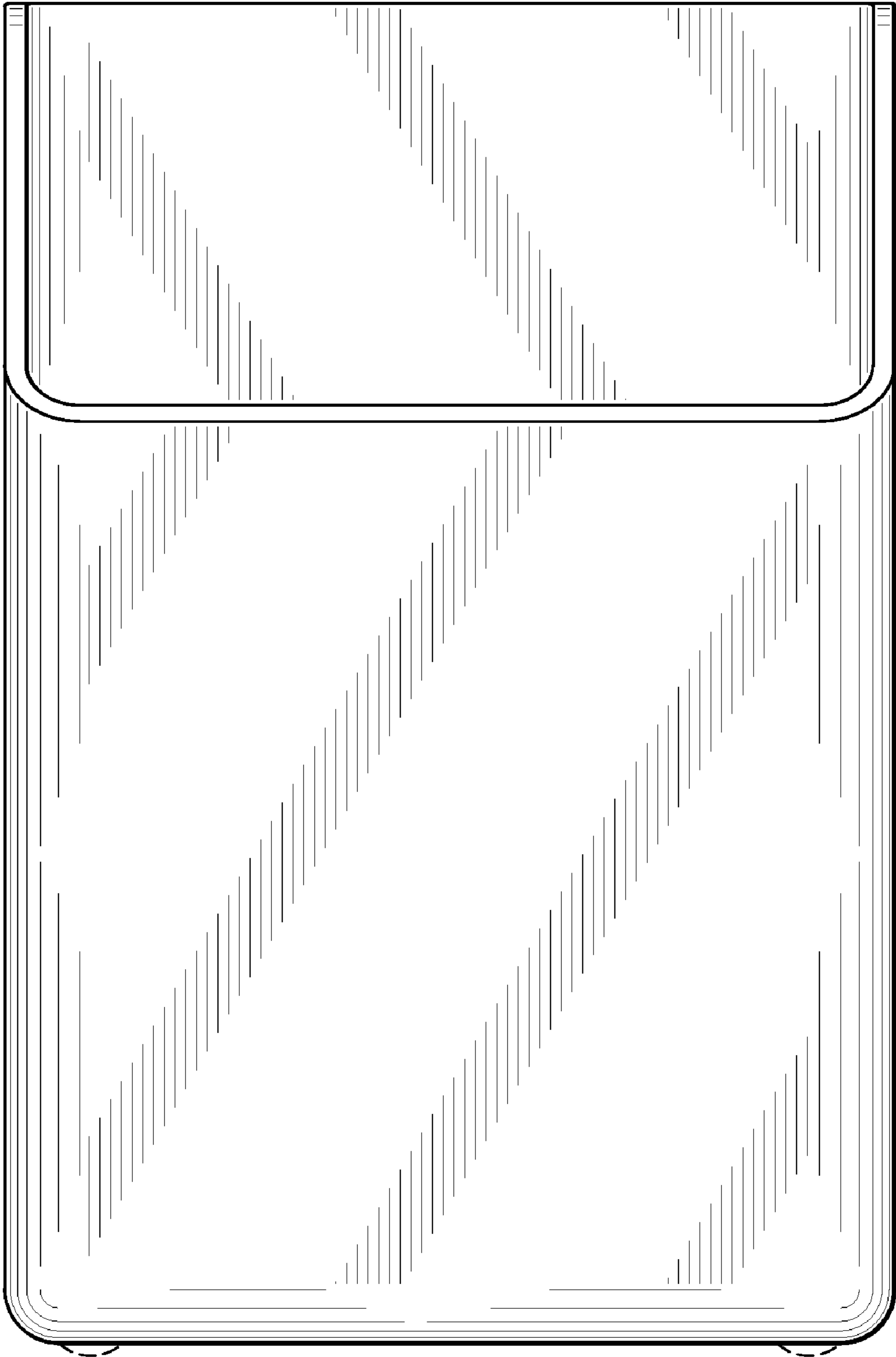

FIG. 9

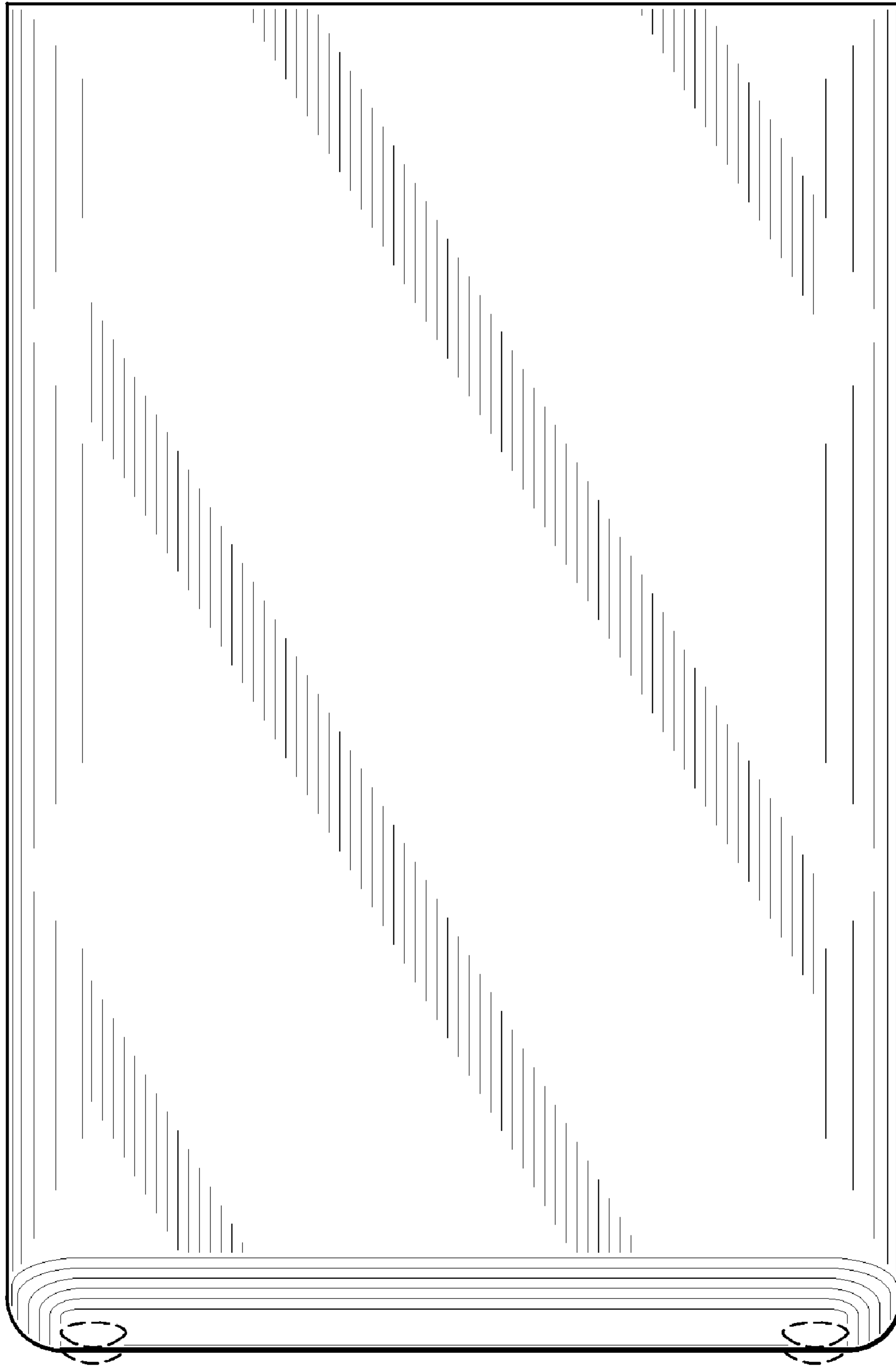

FIG. 10

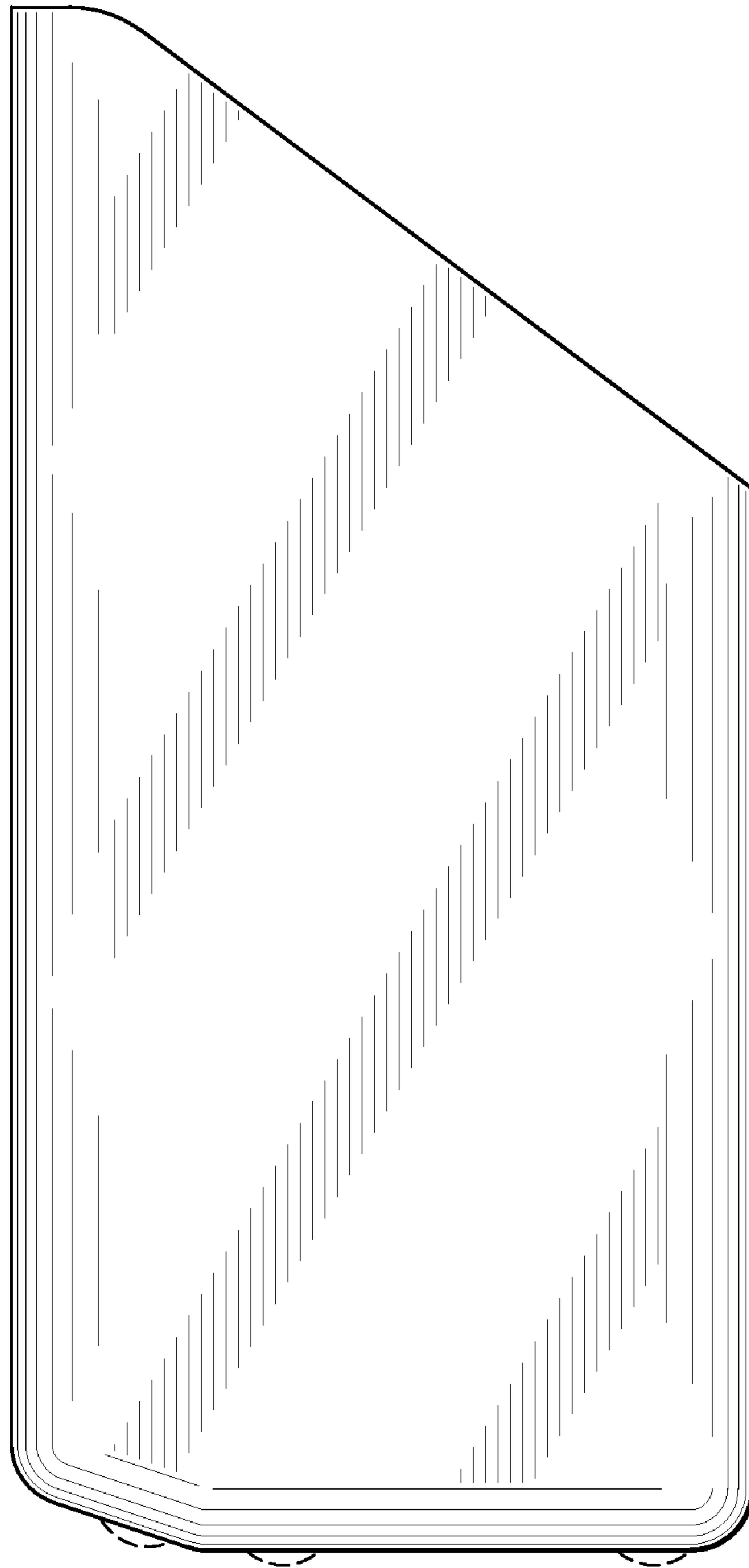

FIG. 11

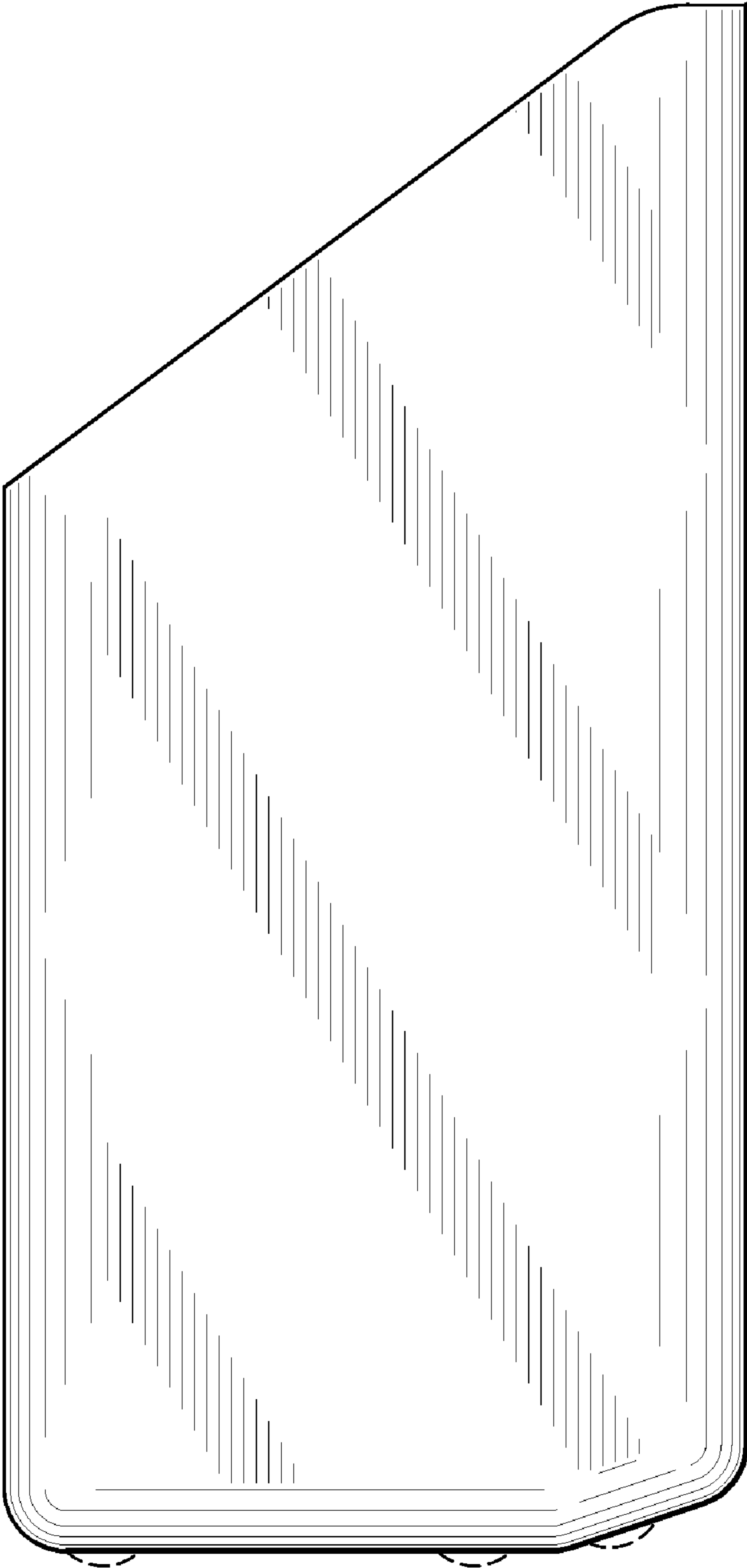

FIG. 12

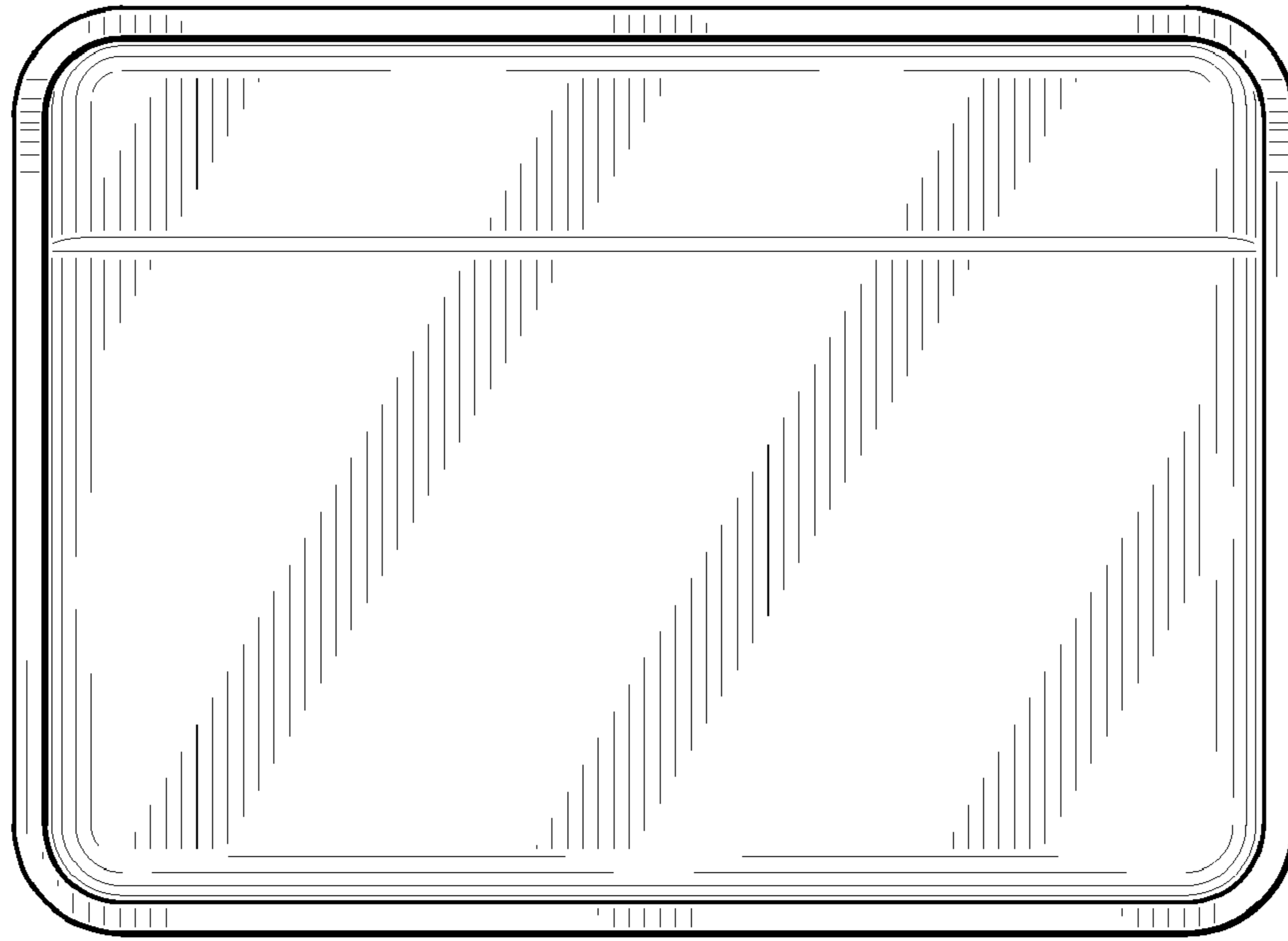

FIG. 13

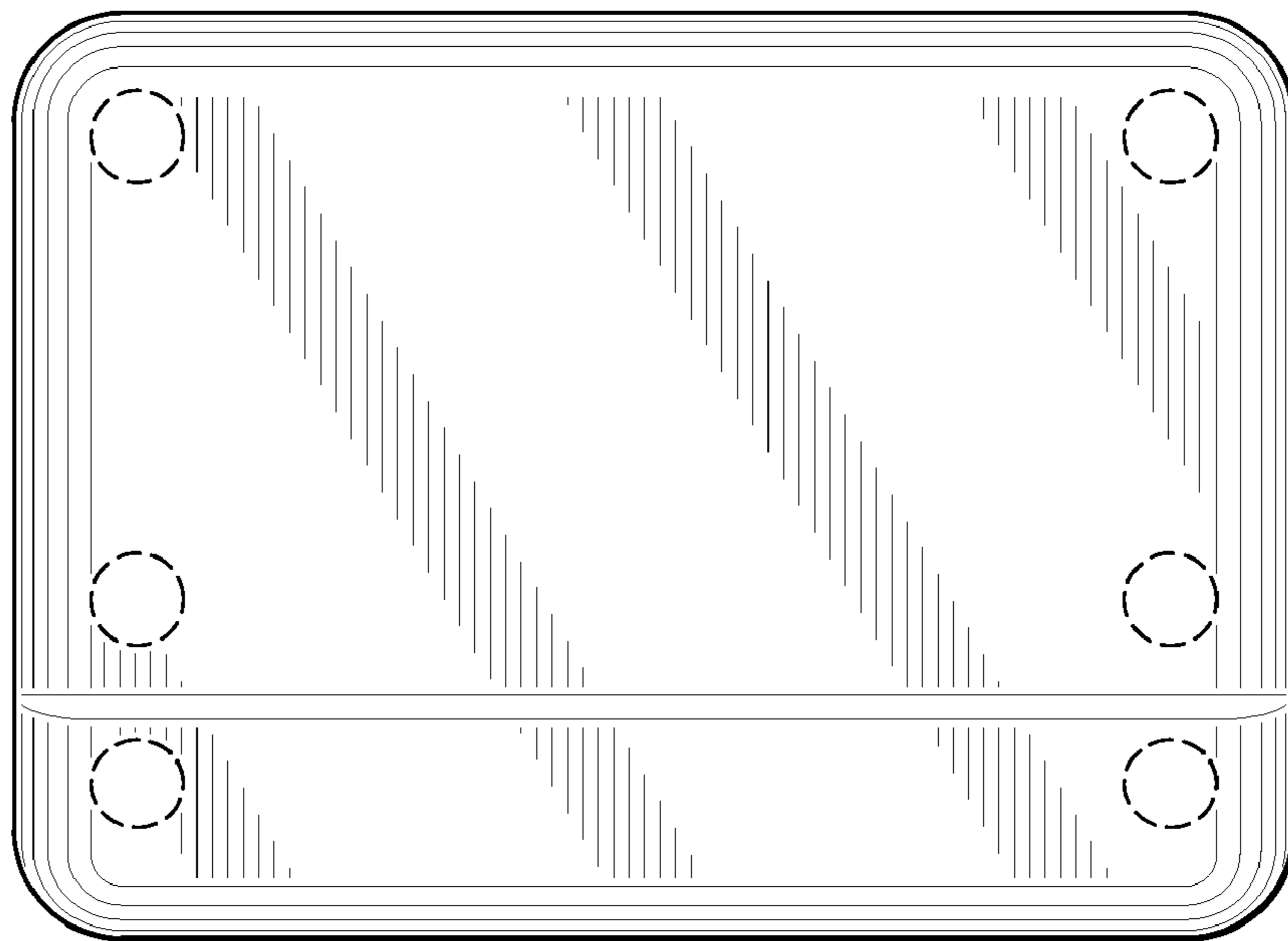

FIG. 14