



(12) **United States Design Patent**
Dearborn et al.

(10) **Patent No.:** **US D593,565 S**
(45) **Date of Patent:** **** Jun. 2, 2009**

(54) **INFORMATION HANDLING SYSTEM BEZEL**

D564,525 S * 3/2008 Chen et al. D14/442
D576,167 S * 9/2008 Dearborn et al. D14/444
7,420,800 B1 * 9/2008 Knapp et al. 361/679.55

(75) Inventors: **Timothy C. Dearborn**, Lakeway, TX (US); **Scott Lauffer**, Austin, TX (US); **Bryan K. Hunter**, Round Rock, TX (US); **Mark Gilson**, Austin, TX (US)

* cited by examiner

(73) Assignee: **Dell Products L.P.**, Round Rock, TX (US)

Primary Examiner—Freda S Nunn
(74) *Attorney, Agent, or Firm*—Stephen A. Terrile; Hamilton & Terrile, LLP

(**) Term: **14 Years**

(57) **CLAIM**

(21) Appl. No.: **29/326,524**

The ornamental design for information handling system bezel, as shown and described.

(22) Filed: **Oct. 20, 2008**

DESCRIPTION

Related U.S. Application Data

(63) Continuation-in-part of application No. 29/325,855, filed on Oct. 7, 2008.

FIG. 1 is a front perspective view of the information handling system bezel comprising the present invention;

(51) **LOC (9) Cl.** **14-02**

FIG. 2 is a front view thereof;

(52) **U.S. Cl.** **D14/445; D14/313**

FIG. 3 is a right side view thereof;

(58) **Field of Classification Search** D14/441-446, D14/356, 313, 360-368; D13/162, 184, D13/199; 312/223.2; 361/686, 690-696, 361/679.55; 369/34.01, 36.01; D6/300
See application file for complete search history.

FIG. 4 is a left side view thereof;

FIG. 5 is a back view thereof;

FIG. 6 is a top view thereof; and,

FIG. 7 is a bottom view thereof.

Broken lines shown in the drawings illustrate portions of the information handling system bezel, and form no part of the claimed design.

(56) **References Cited**

U.S. PATENT DOCUMENTS

D564,523 S * 3/2008 Chen et al. D14/442

1 Claim, 3 Drawing Sheets

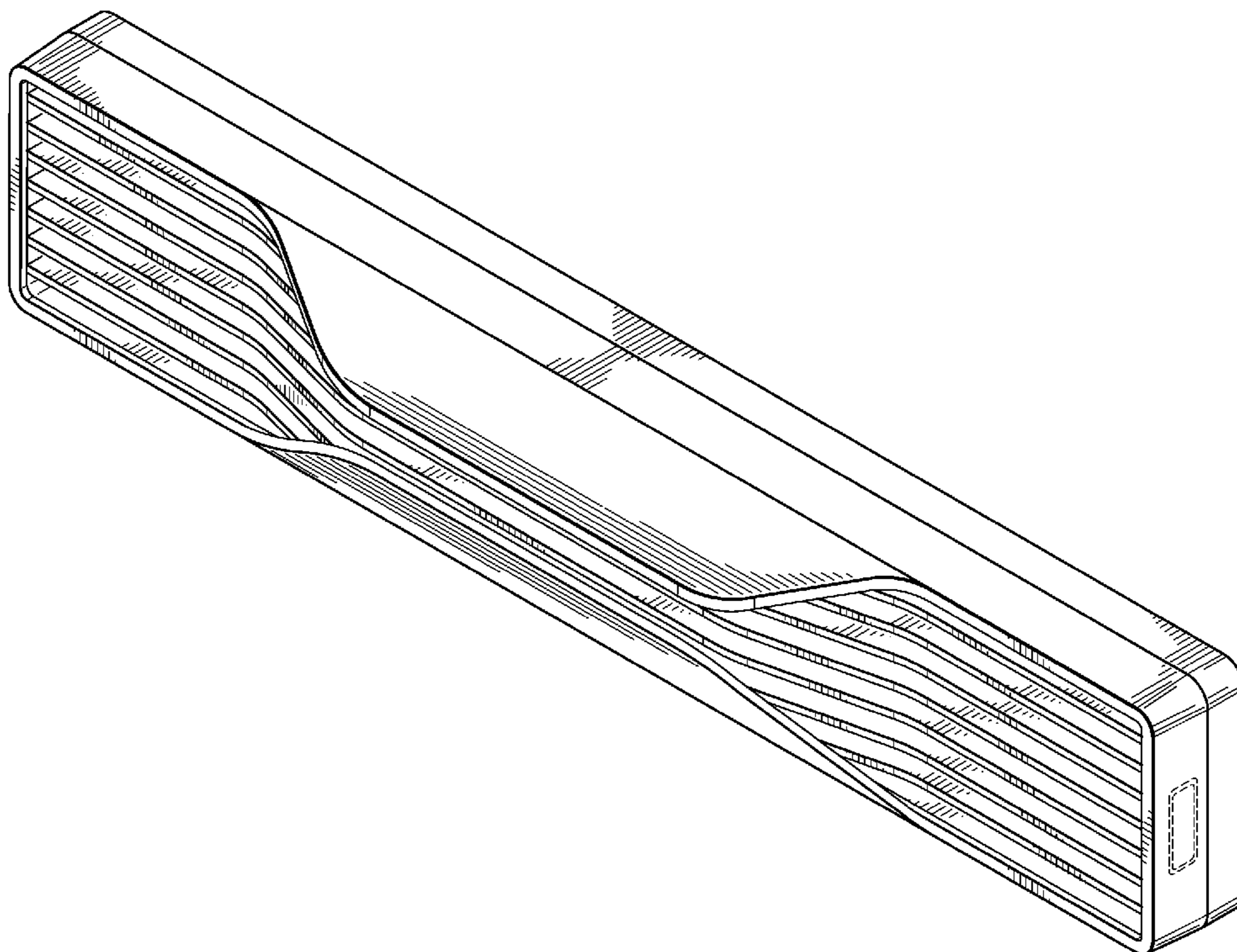

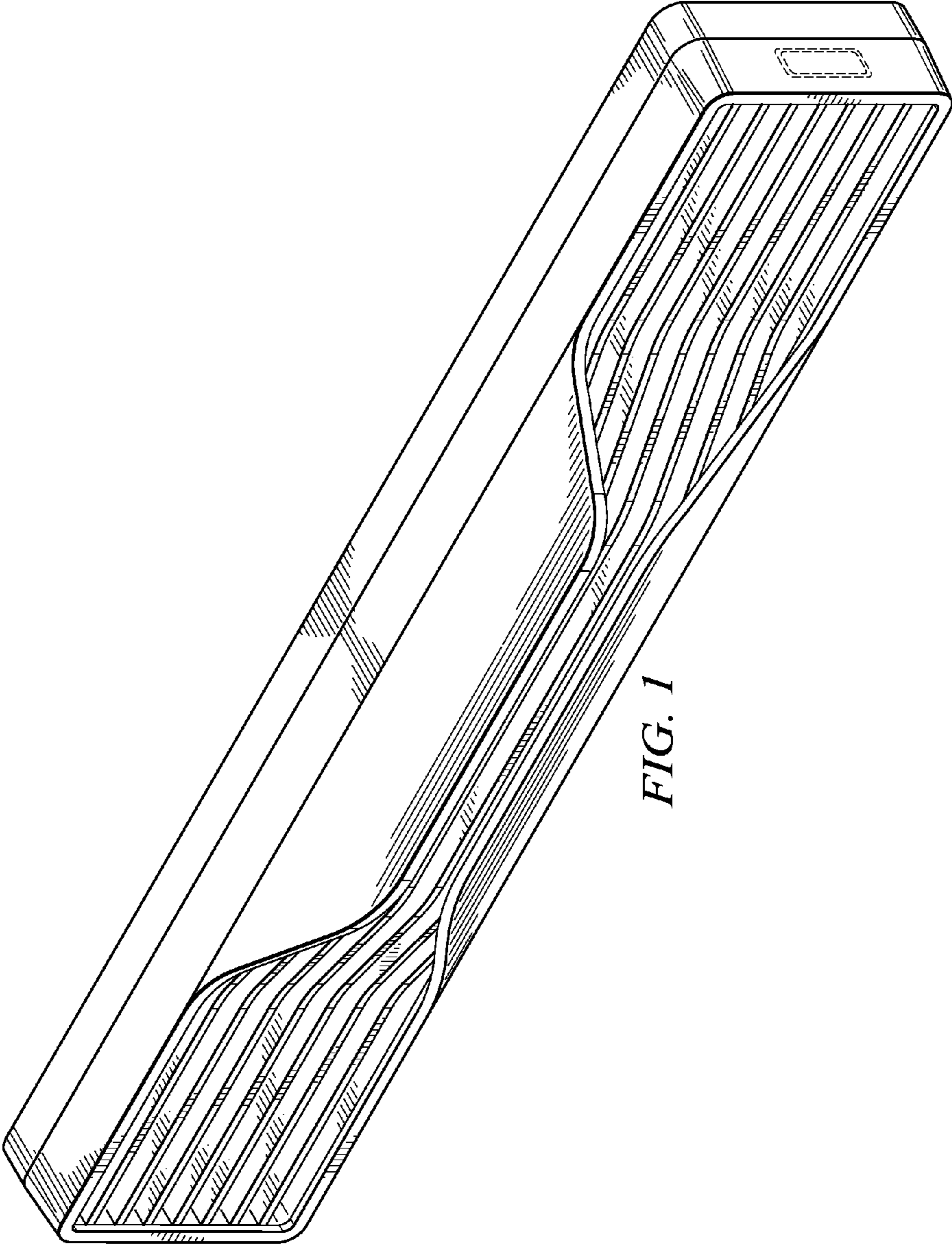

FIG. 1

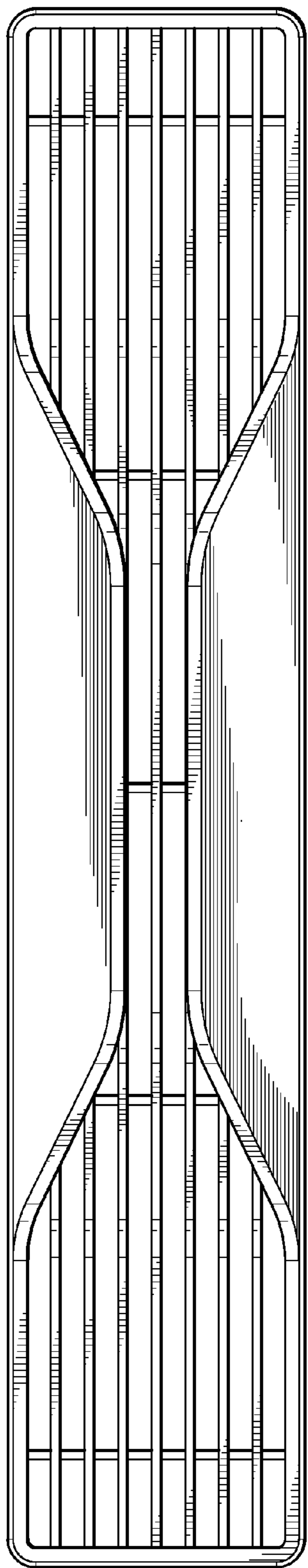

FIG. 2

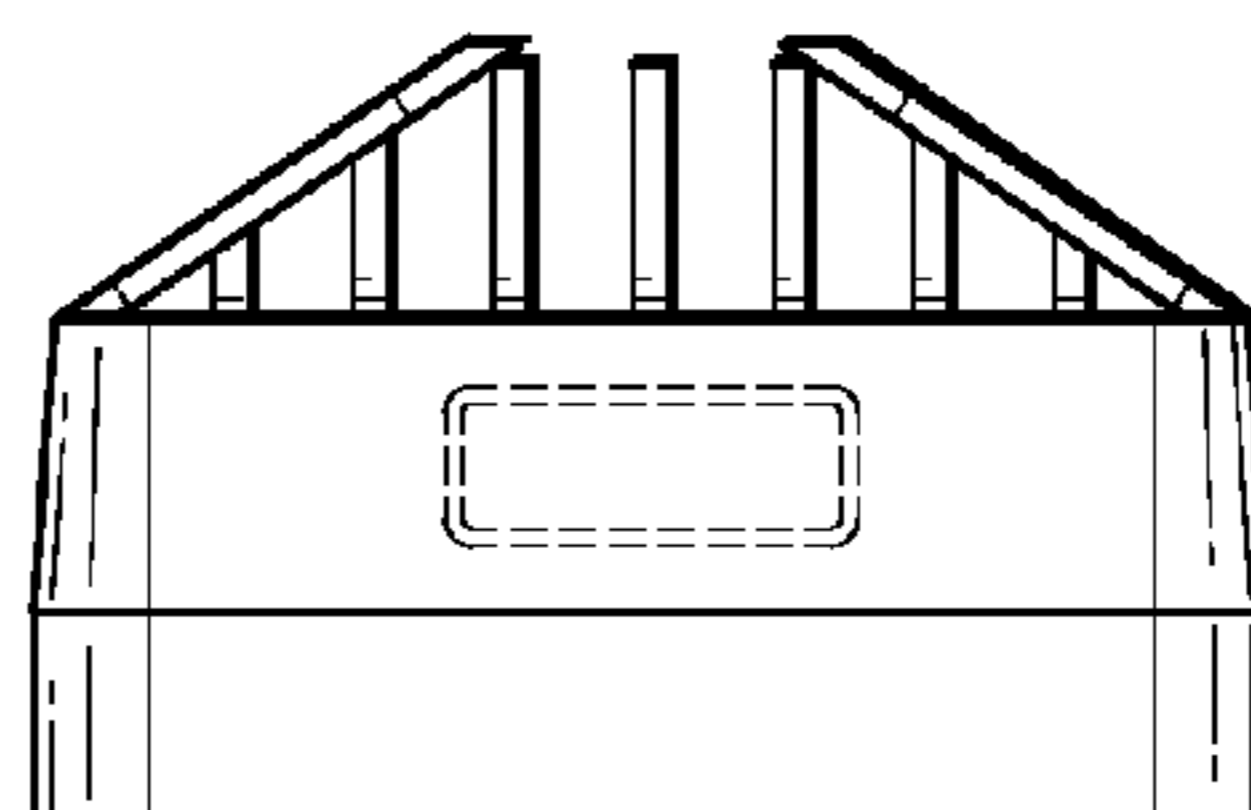

FIG. 4

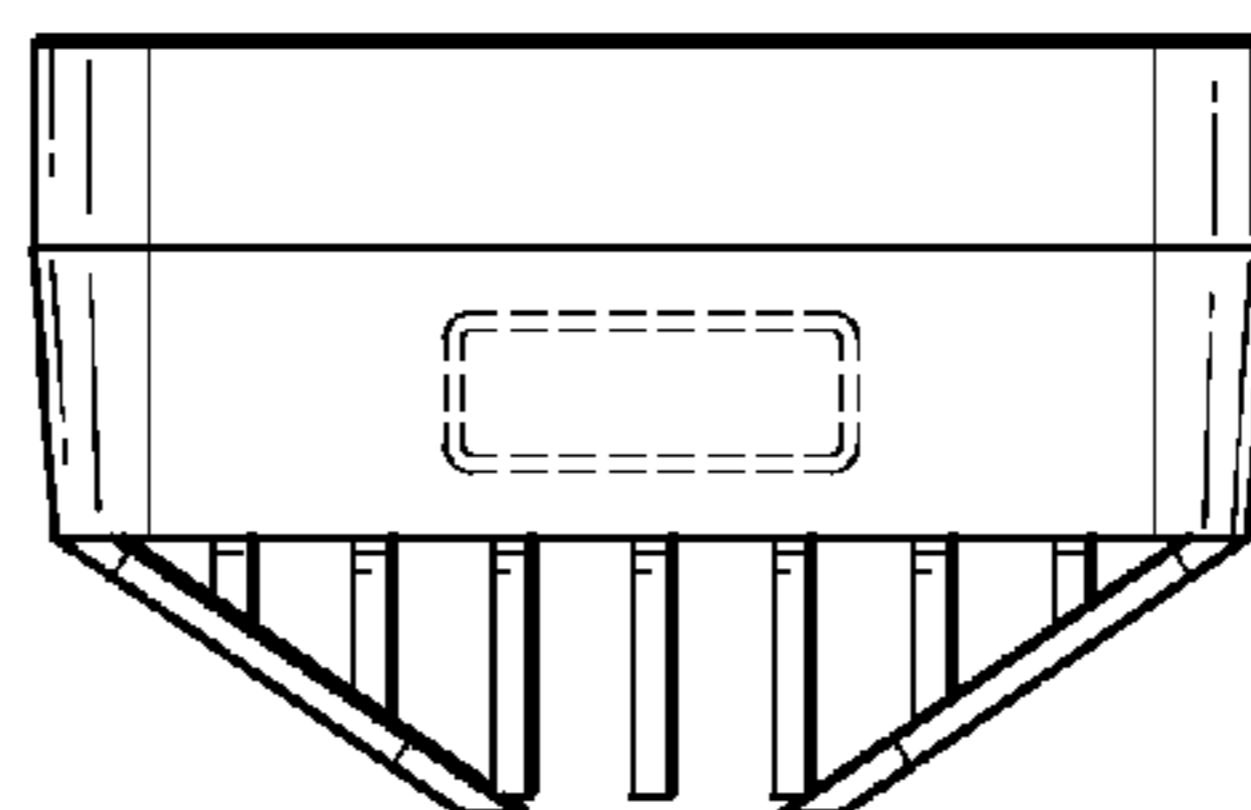

FIG. 3

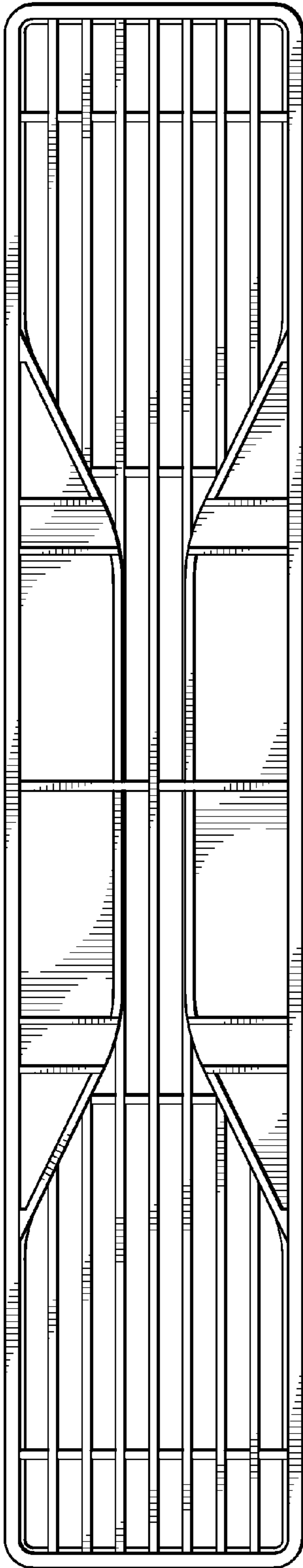

FIG. 5

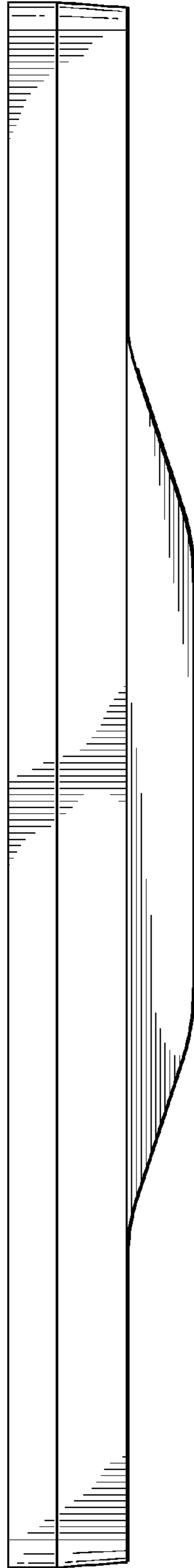

FIG. 6

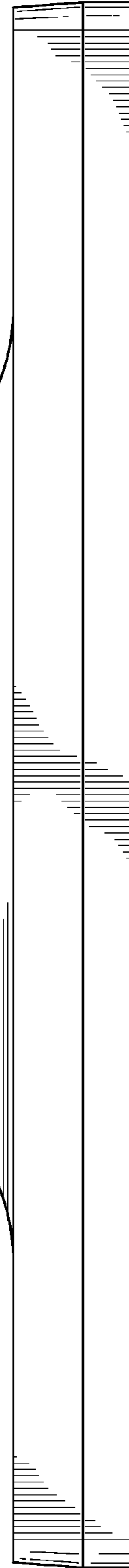

FIG. 7