



US00D593520S

(12) **United States Design Patent**
Misawa

(10) **Patent No.:** **US D593,520 S**
(45) **Date of Patent:** **** Jun. 2, 2009**

(54) **MOBILE-PHONE**

(75) Inventor: **Atsushi Misawa**, Saitama (JP)

(73) Assignee: **Fujifilm Corporation**, Tokyo (JP)

(**) Term: **14 Years**

(21) Appl. No.: **29/295,948**

(22) Filed: **Oct. 11, 2007**

(30) **Foreign Application Priority Data**

Apr. 11, 2007 (JP) 2007-009706

(51) **LOC (9) Cl.** **14-03**

(52) **U.S. Cl.** **D14/138 AB**

(58) **Field of Classification Search** D14/138 AB,
D14/138 AA, 496, 341-347, 247, 455-456,
D14/218; 455/575.3, 575.1

See application file for complete search history.

(56) **References Cited**

U.S. PATENT DOCUMENTS

D505,407 S * 5/2005 Itano D14/138 AC

(Continued)

OTHER PUBLICATIONS

Motorola U9 telephone, announced Oct. 2007, [online], [site visited Nov. 4, 2008]. Available from Internet, <URL: <http://www.gsmarena.com>>.*

Sony Ericsson Z250 telephone, announced Jun. 2007, [online], [site visited Nov. 4, 2008]. Available from Internet, <URL: <http://www.gsmarena.com>>.*

Alcatel OT-S319 telephone, announced Feb. 2007, [online], [site visited Nov. 4, 2008]. Available from Internet, <URL: <http://www.gsmarena.com>>.*

(Continued)

Primary Examiner—Jeffrey D Asch

(74) *Attorney, Agent, or Firm*—Young & Thompson

(57) **CLAIM**

The ornamental design for a mobile-phone, as shown and described.

DESCRIPTION

FIG. 1 is a front elevational view, in a folded position with the top portion slightly rotated to the right, of a mobile-phone showing my new design;

FIG. 2 is a rear elevational view thereof;

FIG. 3 is a top plan view thereof;

FIG. 4 is a bottom plan view thereof;

FIG. 5 is a left side elevational view thereof;

FIG. 6 is a right side elevational view thereof;

FIG. 7 is a top, front, and right side perspective view thereof in an unfolded position;

FIG. 8 is a front elevational view thereof;

FIG. 9 is a rear elevational view thereof;

FIG. 10 is a top plan view thereof;

FIG. 11 is a bottom plan view thereof;

FIG. 12 is a left side elevational view thereof;

FIG. 13 is a top, front, and right side perspective view thereof in a folded position with the top and rear portions in alignment;

FIG. 14 is a front elevational view thereof;

FIG. 15 is a rear elevational view thereof;

FIG. 16 is a top plan view thereof;

FIG. 17 is a bottom plan view thereof; and,

FIG. 18 is a left side elevational view thereof.

The broken lines throughout the views, which are immediately adjacent to the shaded areas and define unshaded regions, represent the bounds of the claimed design, while all other broken lines are directed to environment and are for illustrative purposes only; the broken lines form no part of the claimed design.

1 Claim, 9 Drawing Sheets

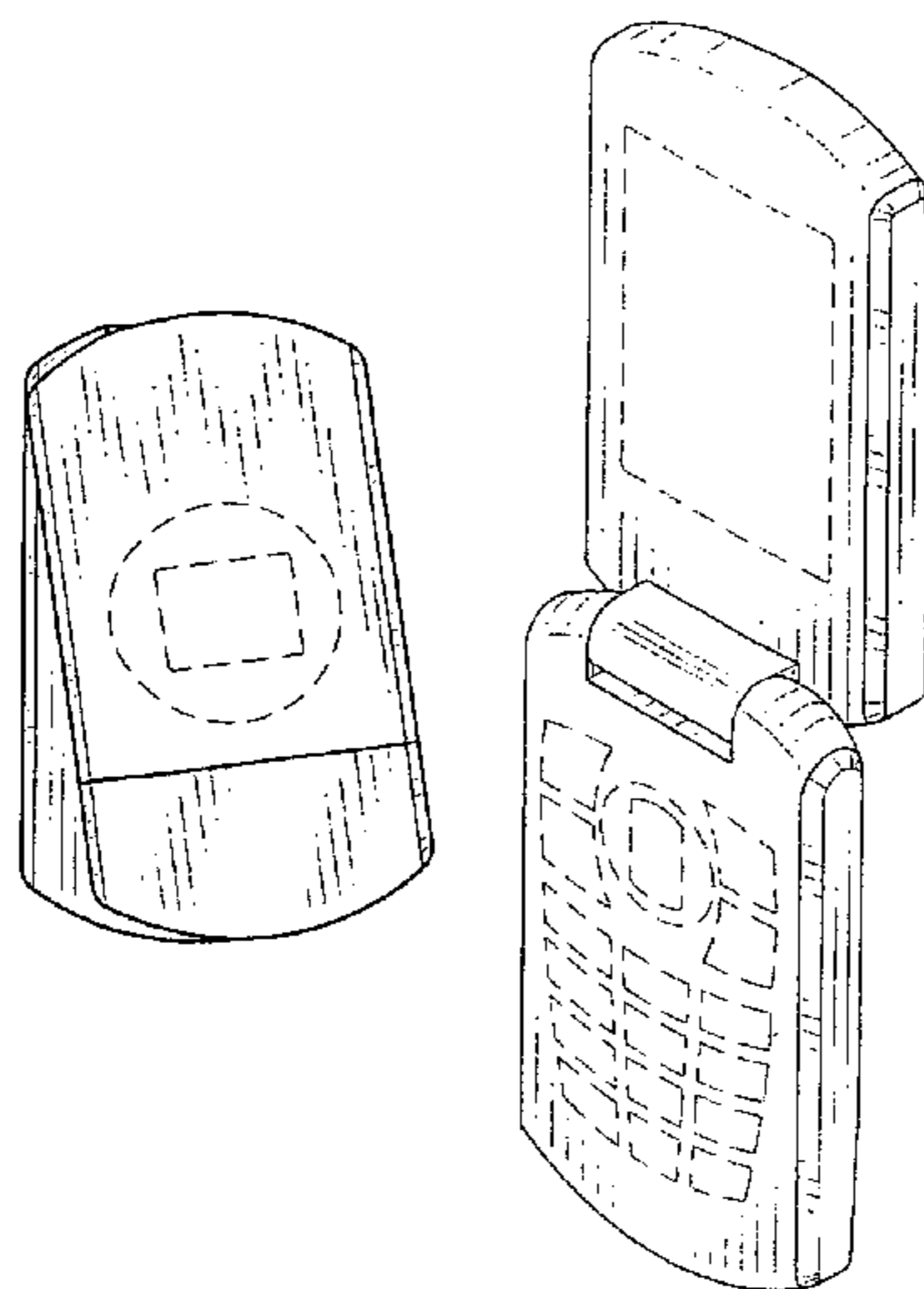

U.S. PATENT DOCUMENTS

D519,478 S * 4/2006 Lee et al. D14/138 AB
 D519,971 S * 5/2006 Morita et al. D14/138 AB
 7,187,957 B2 * 3/2007 Kato 455/575.3
 D539,773 S * 4/2007 Kim et al. D14/138 AC
 D542,254 S * 5/2007 Ahn et al. D14/138 AB
 D542,255 S * 5/2007 Hong et al. D14/138 AB
 D556,719 S * 12/2007 Lee D14/138 AB
 D559,814 S * 1/2008 Kim et al. D14/138 AB
 D561,158 S * 2/2008 Heng et al. D14/138 AB
 7,346,377 B2 * 3/2008 Sakai et al. 455/575.3
 D566,084 S * 4/2008 Oh et al. D14/138 AB
 D566,087 S * 4/2008 Choi D14/138 AB
 D566,670 S * 4/2008 Huang D14/138 AB
 D571,340 S * 6/2008 Song et al. D14/138
 D574,801 S * 8/2008 Arnold D14/138
 D575,755 S * 8/2008 Kim et al. D14/138
 D576,599 S * 9/2008 Han et al. D14/138 AB
 D576,600 S * 9/2008 Kim et al. D14/138 AB

D578,498 S * 10/2008 Choi et al. D14/138 AB
 D578,982 S * 10/2008 Jeong et al. D14/138 R
 2004/0235540 A1 * 11/2004 Yajima 455/575.3
 2006/0046792 A1 * 3/2006 Hassemer et al. 455/575.1
 2006/0098813 A1 * 5/2006 Takamori et al. 379/433.13
 2006/0154702 A1 * 7/2006 Kang et al. 455/575.3
 2006/0223596 A1 * 10/2006 Hur 455/575.4
 2007/0149262 A1 * 6/2007 Navntoft 455/575.3
 2007/0178949 A1 * 8/2007 Sato et al. 455/575.3

OTHER PUBLICATIONS

Philips 598 telephone, announced Mar. 2007, [online], [site visited Nov. 4, 2008]. Available from Internet, <URL: <http://www.gsmarena.com>>.*

Haier A7 telephone, announced 2006, [online], [site visited Nov. 4, 2008]. Available from Internet, <URL: <http://www.gsmarena.com>>.*

* cited by examiner

FIG. 1

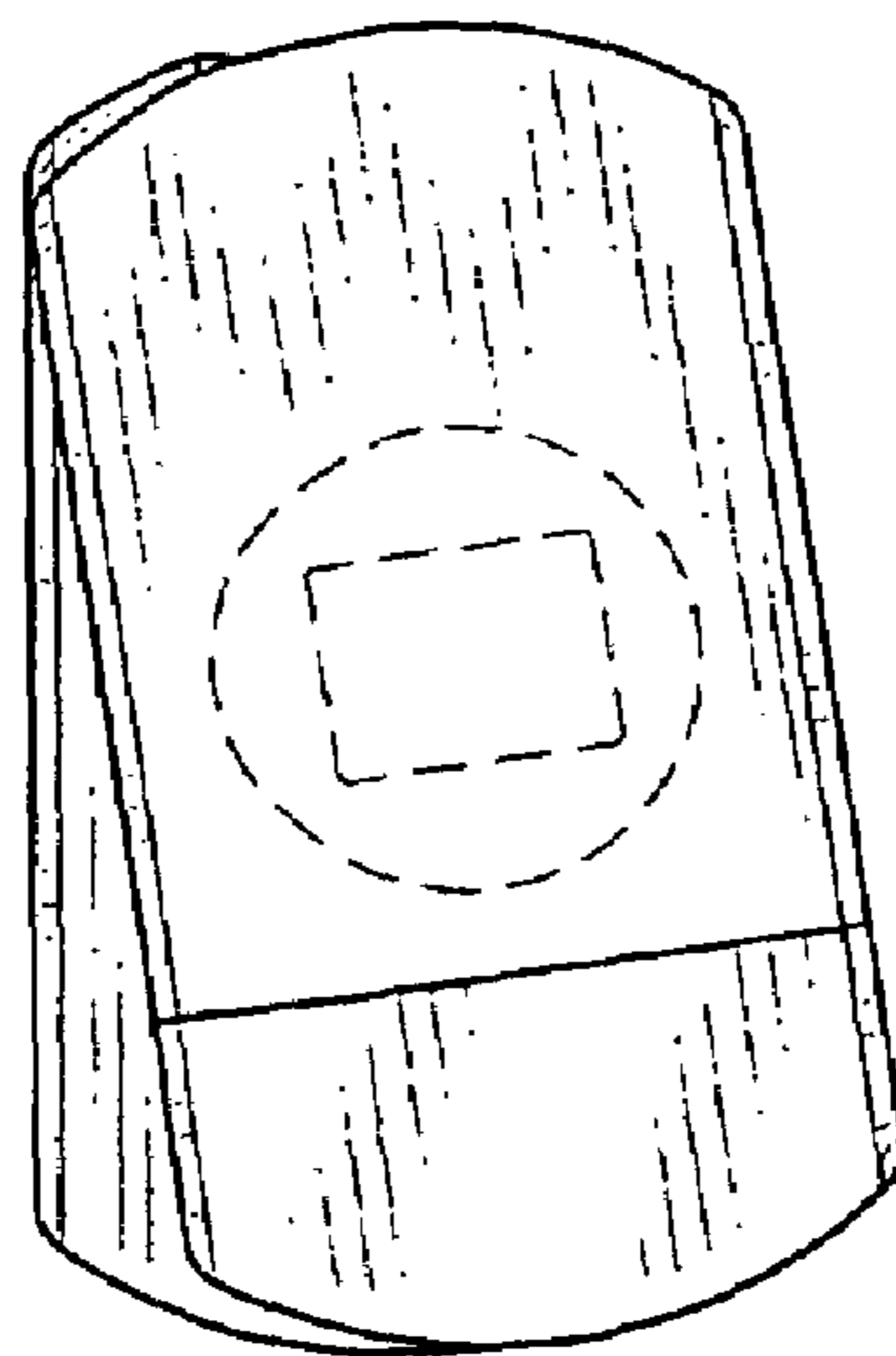

FIG. 2

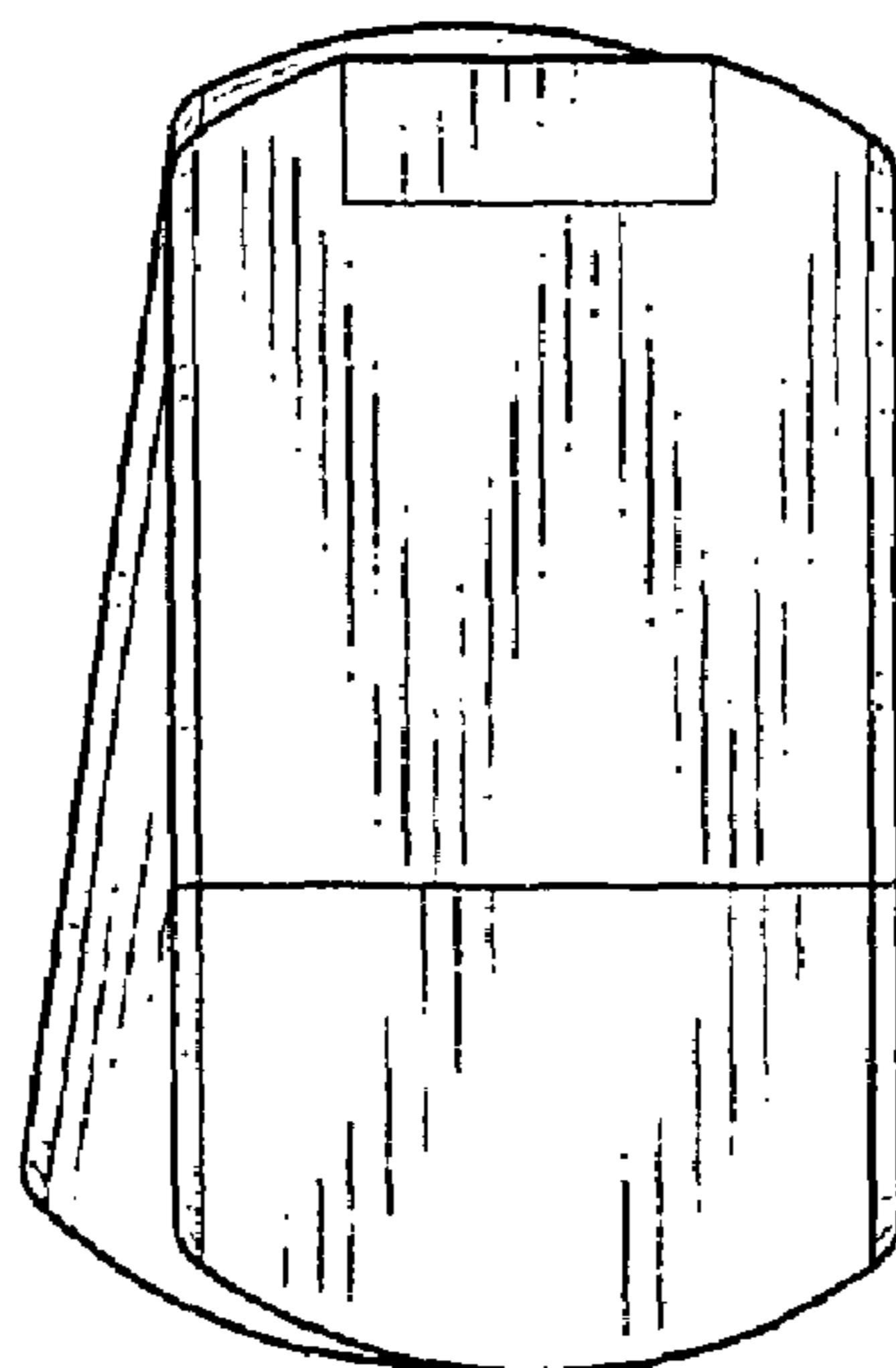

FIG. 3

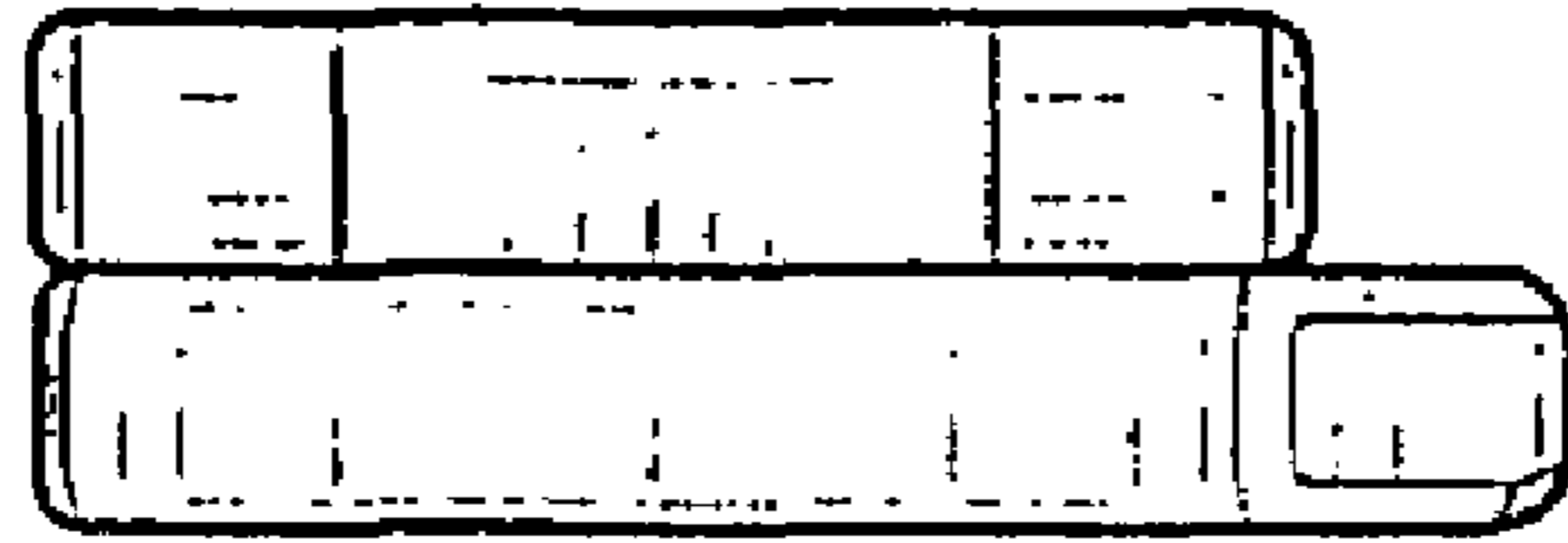

FIG. 4

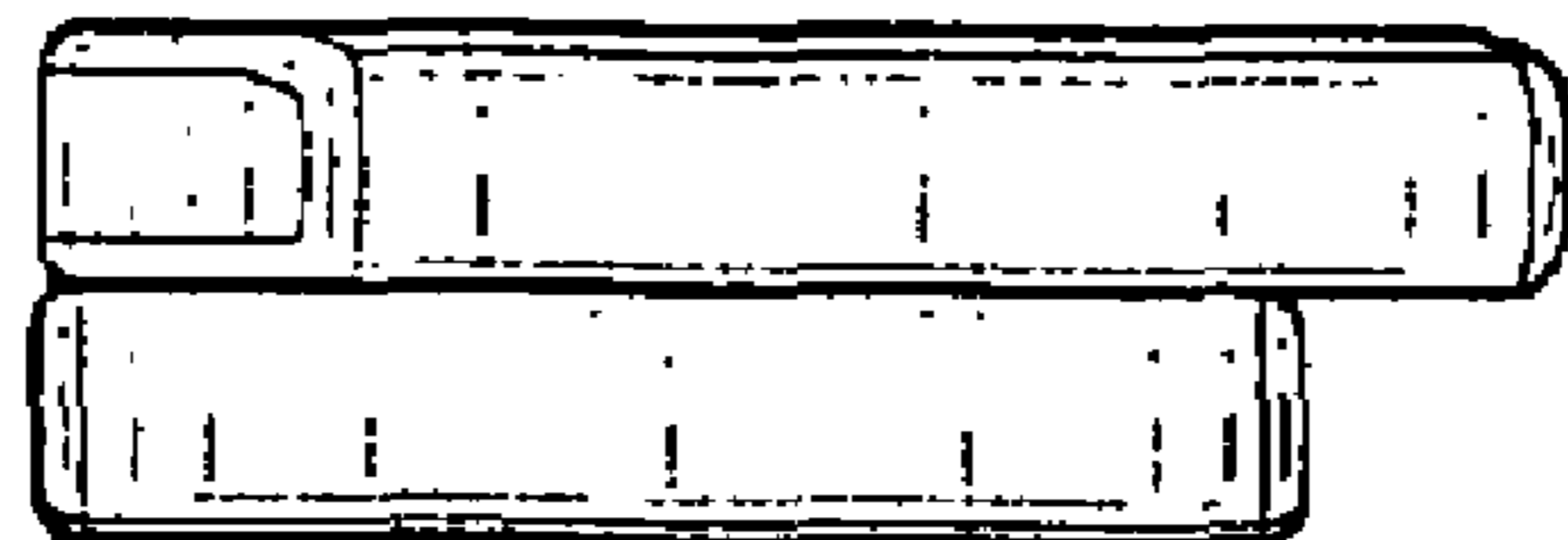

FIG.5



FIG.6



FIG.7

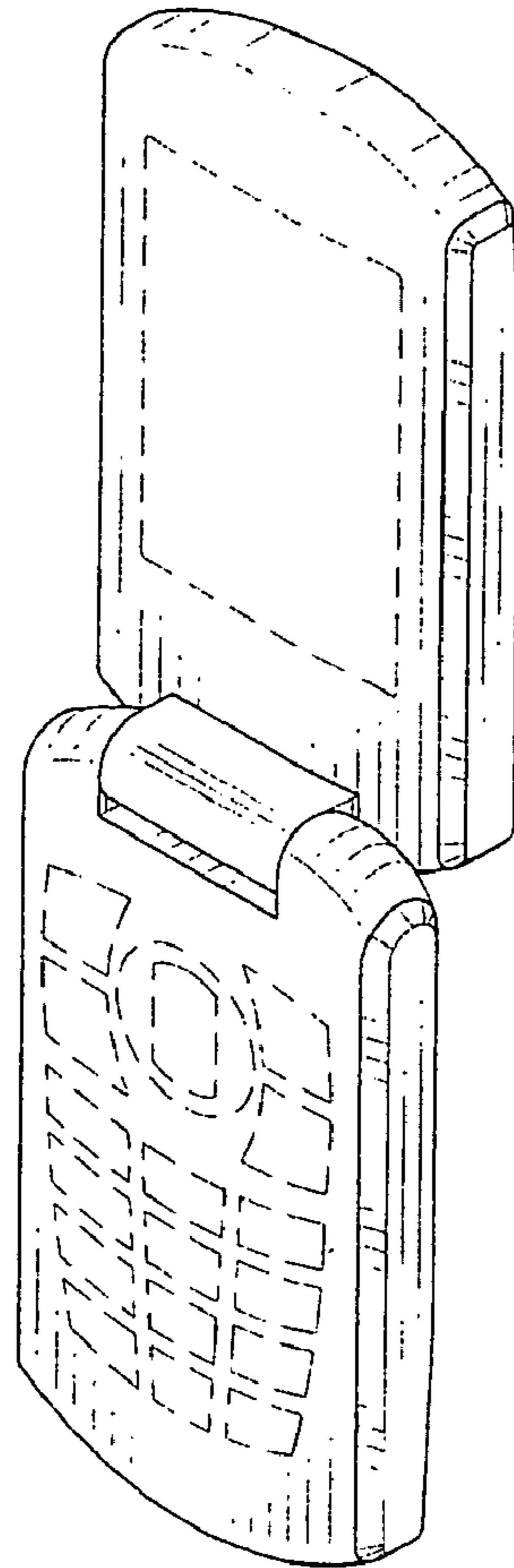

FIG.8

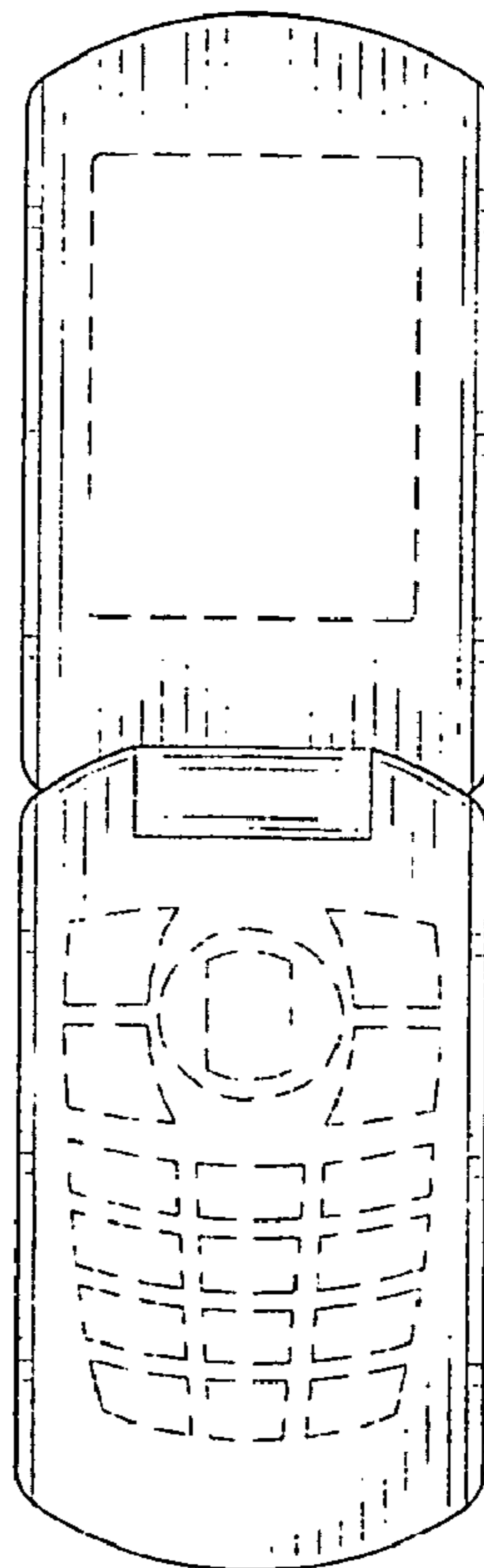

FIG.9

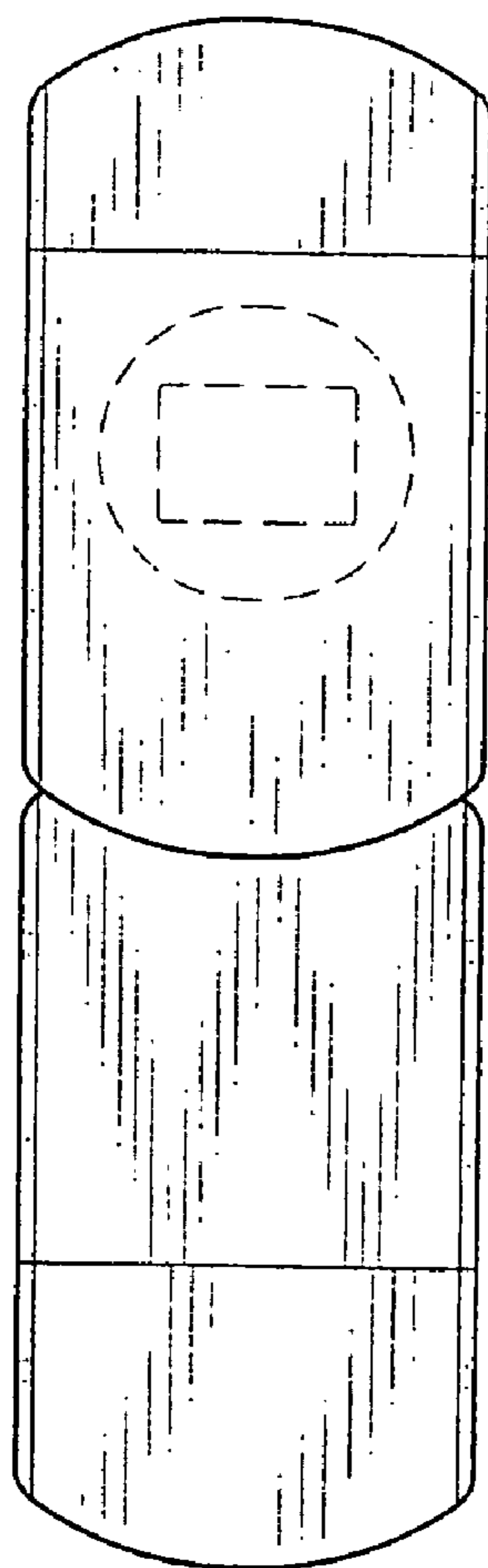

FIG.10

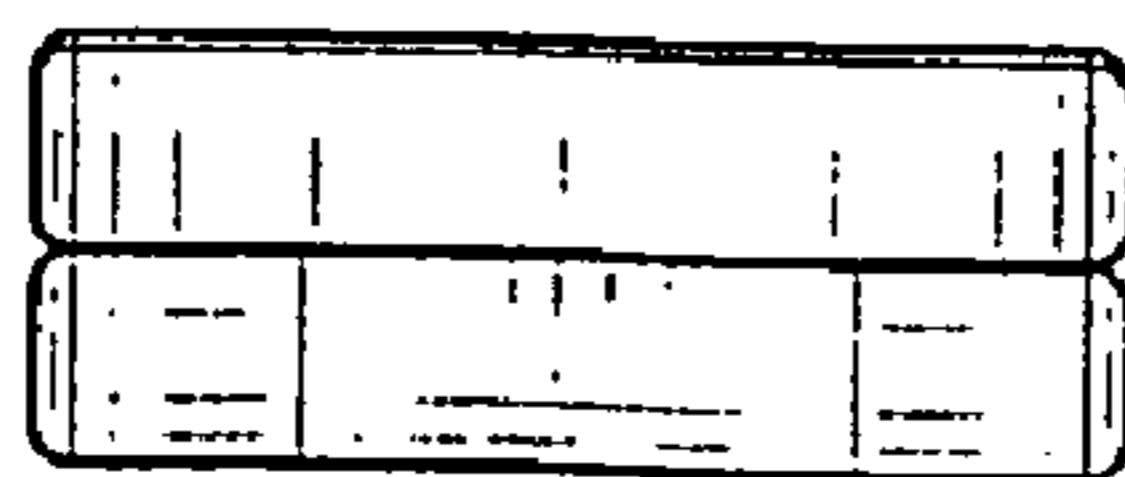

FIG. 11

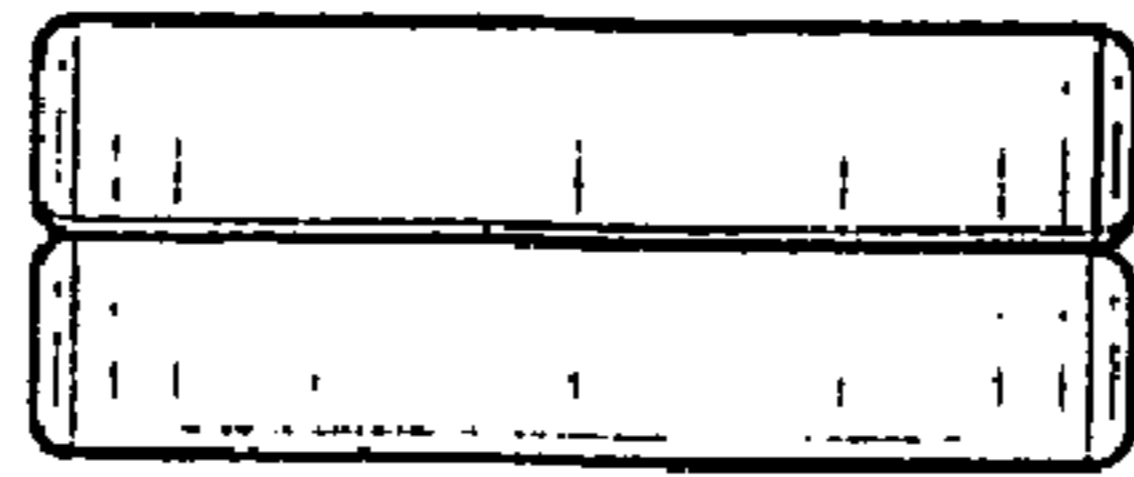

FIG. 12

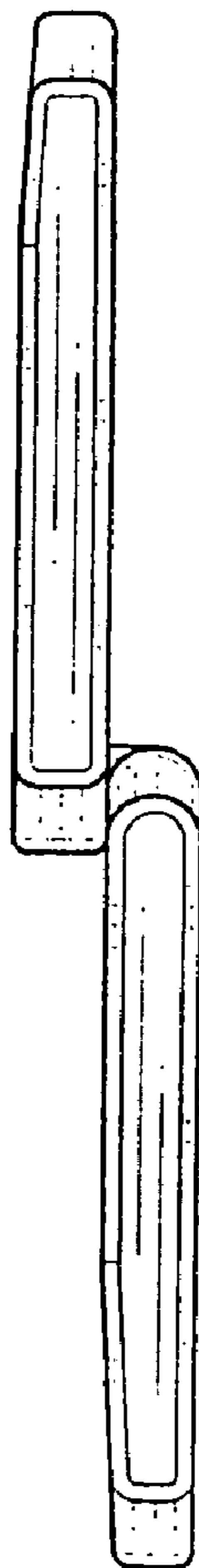

FIG. 13

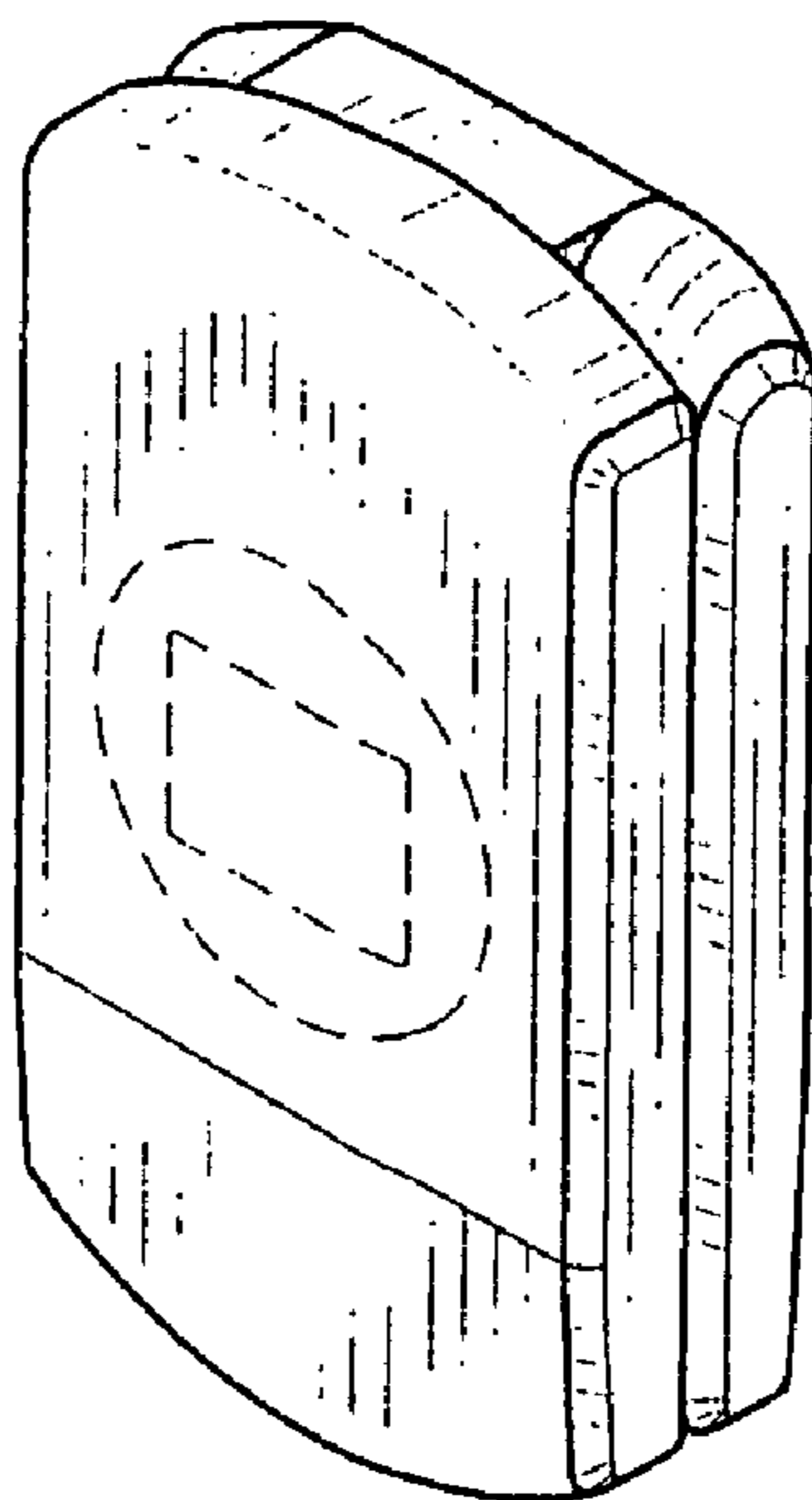

FIG. 14

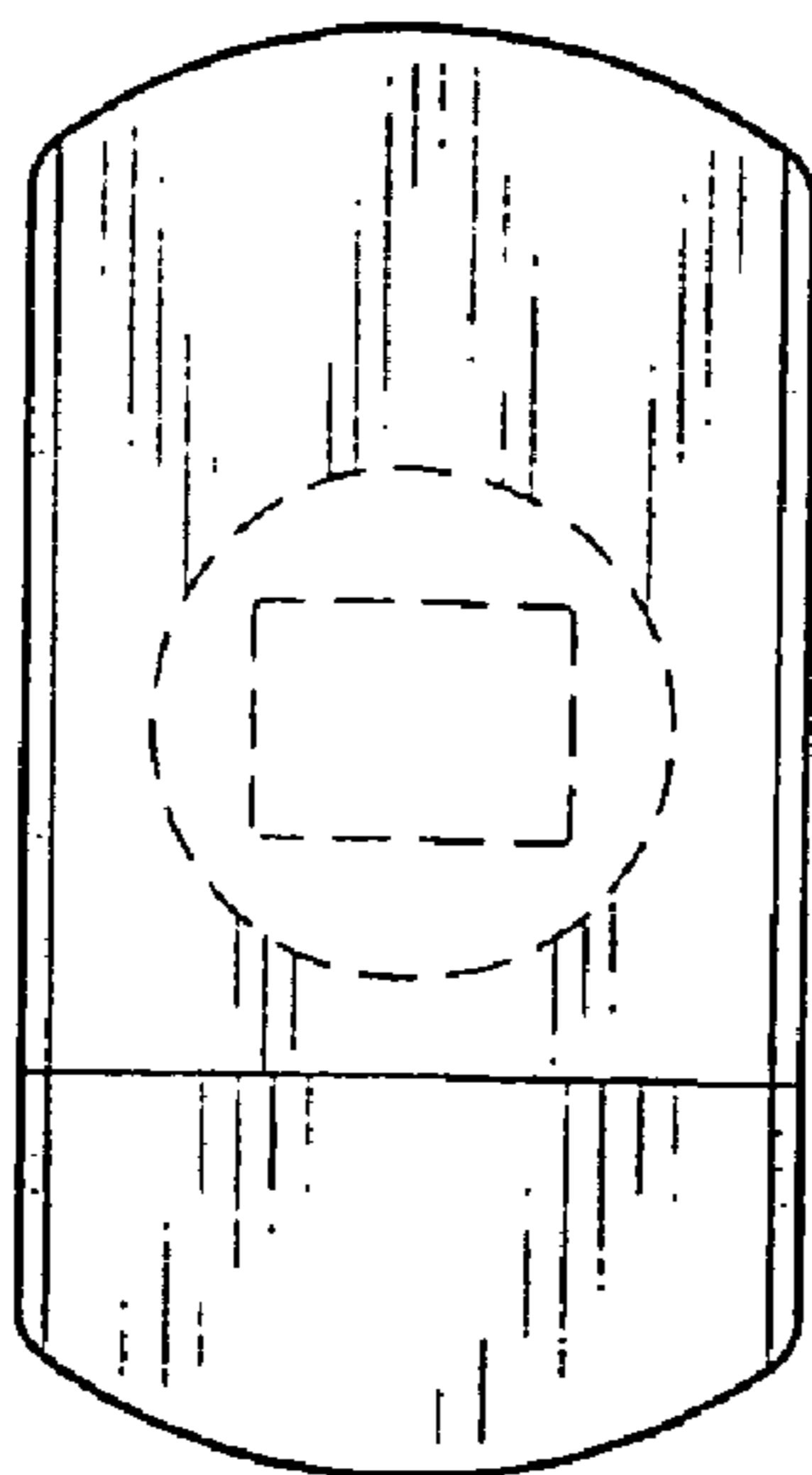

FIG.15

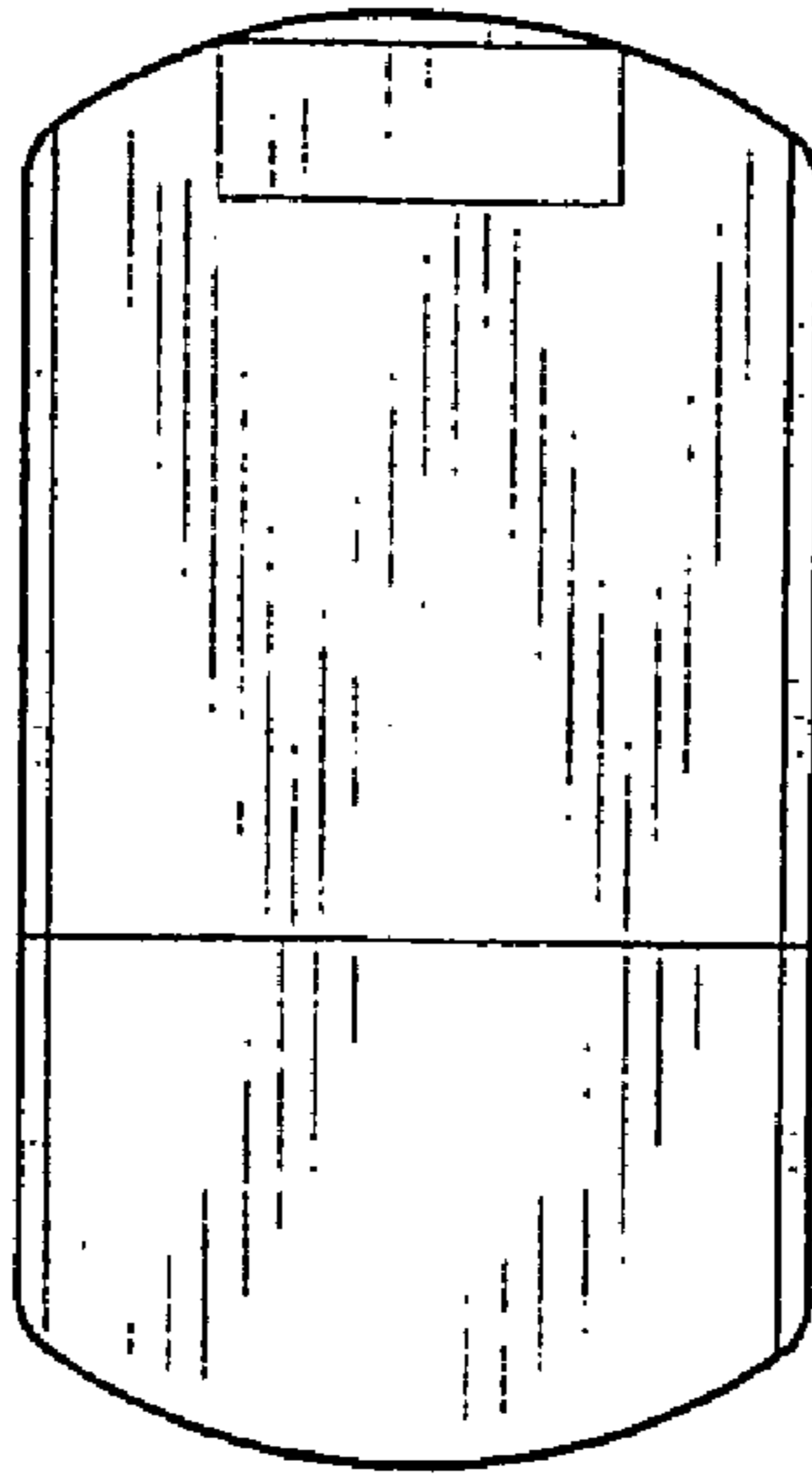

FIG.16

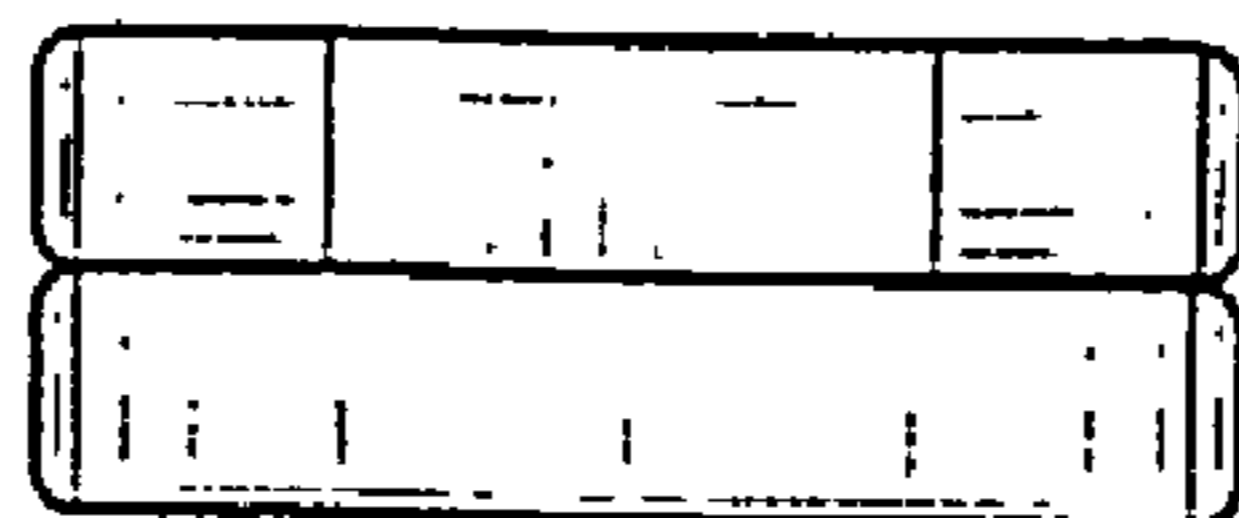

FIG. 17

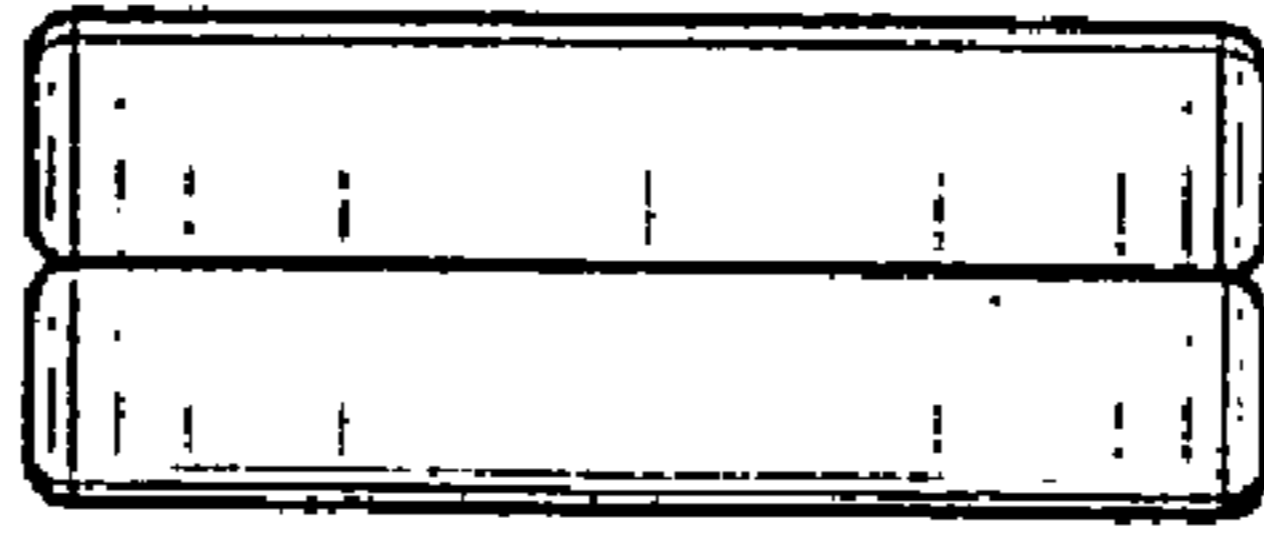

FIG. 18

