



US00D593428S

(12) **United States Design Patent**
Lyons

(10) **Patent No.:** **US D593,428 S**
(45) **Date of Patent:** **** Jun. 2, 2009**

(54) **LIGHTBAR MODULES**

DESCRIPTION

(75) Inventor: **Jon H. Lyons**, Haddam, CT (US)
(73) Assignee: **Whelen Engineering Company, Inc.**,
Chester, CT (US)
(**) Term: **14 Years**
(21) Appl. No.: **29/308,125**
(22) Filed: **May 29, 2008**
(51) **LOC (9) Cl.** **10-05**
(52) **U.S. Cl.** **D10/114**
(58) **Field of Classification Search** D10/114;
D26/28, 31; 362/493, 545, 35, 542, 480,
362/540; 340/468, 404.1, 474, 480; 379/37
See application file for complete search history.

(56) **References Cited**

U.S. PATENT DOCUMENTS

D345,316 S * 3/1994 Green et al. D10/114
D469,711 S * 2/2003 Neufeglise et al. D10/114
D476,253 S * 6/2003 Stein et al. D10/114
D499,976 S * 12/2004 Neufeglise et al. D10/114
2008/0080164 A1 * 4/2008 Mastin 362/35

* cited by examiner

Primary Examiner—Caron Veynar
Assistant Examiner—George D Kirschbaum
(74) *Attorney, Agent, or Firm*—Alix, Yale & Ristas, LLP

(57) **CLAIM**

The ornamental design for the lightbar module, as shown and described.

FIG. 1 is a perspective view of lightbar modules, showing my new design;
FIG. 2 is a front view thereof;
FIG. 3 is a rear view thereof;
FIG. 4 is a left side view thereof;
FIG. 5 is a right side view thereof;
FIG. 6 is a top plan view thereof;
FIG. 7 a bottom plan view thereof;
FIG. 8 is a perspective view of a second embodiment of my design;
FIG. 9 is a front view thereof;
FIG. 10 is a rear view thereof;
FIG. 11 is a left side view thereof;
FIG. 12 is a right side view thereof;
FIG. 13 is a top plan view thereof;
FIG. 14 is a bottom plan view thereof
FIG. 15 is a perspective view of a third embodiment of my design;
FIG. 16 is a front view thereof;
FIG. 17 is a rear view thereof;
FIG. 18 is a left side view thereof;
FIG. 19 is a right side view thereof;
FIG. 20 is a top plan view thereof; and,
FIG. 21 is bottom plan view thereof.
No claim is made to the portions shown in broken lines.

1 Claim, 12 Drawing Sheets

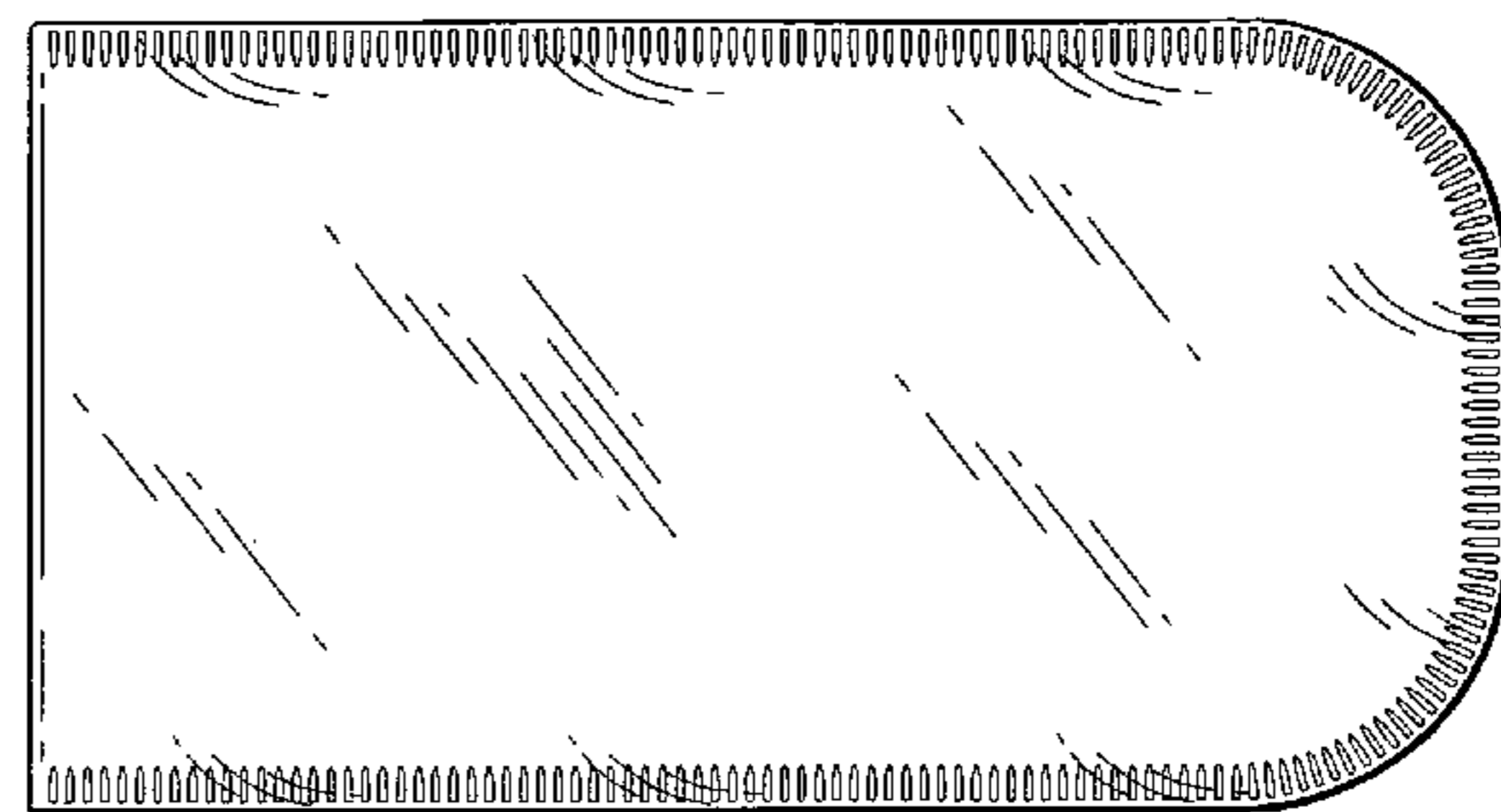
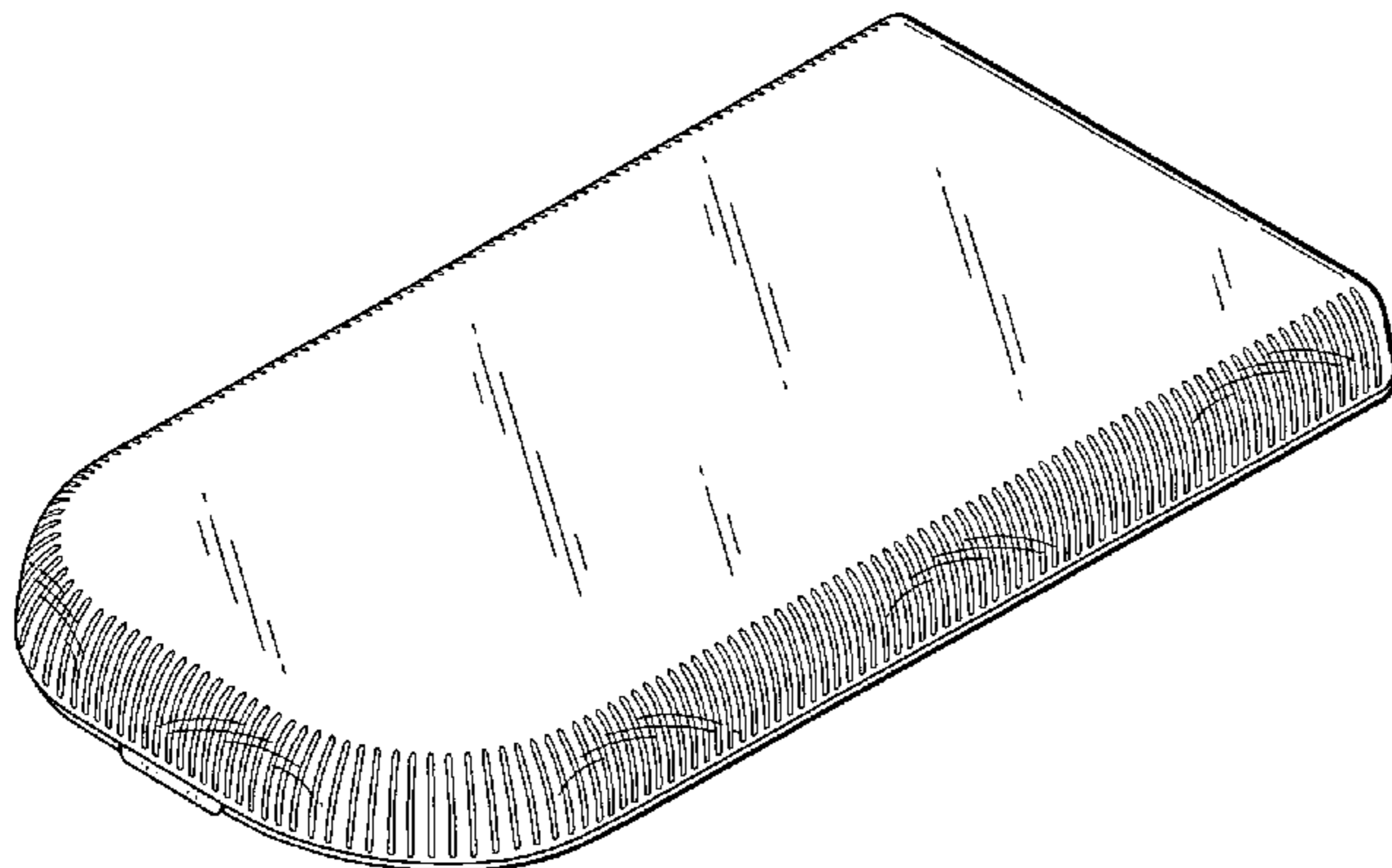

FIG. 1

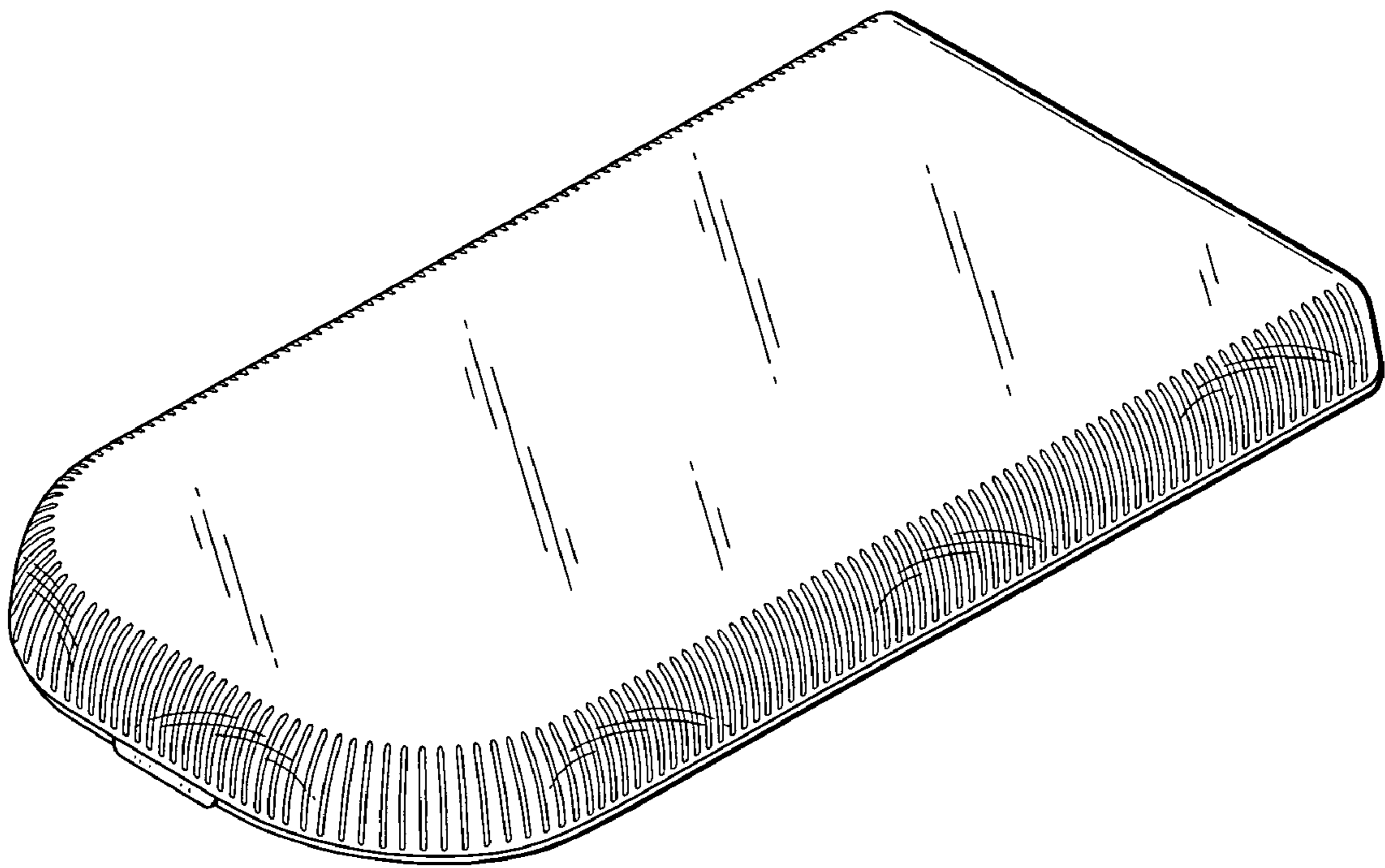

FIG. 2

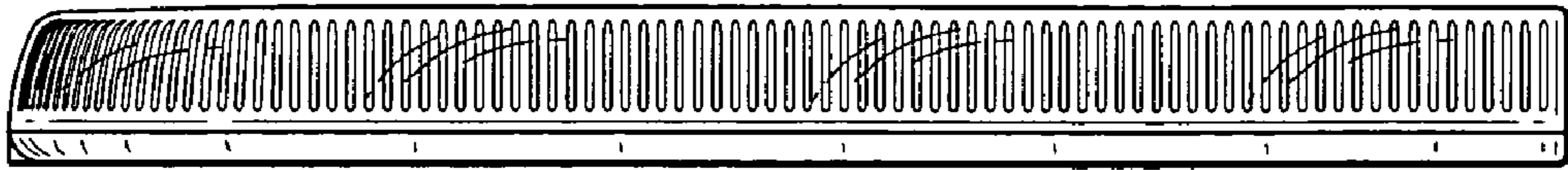

FIG. 3

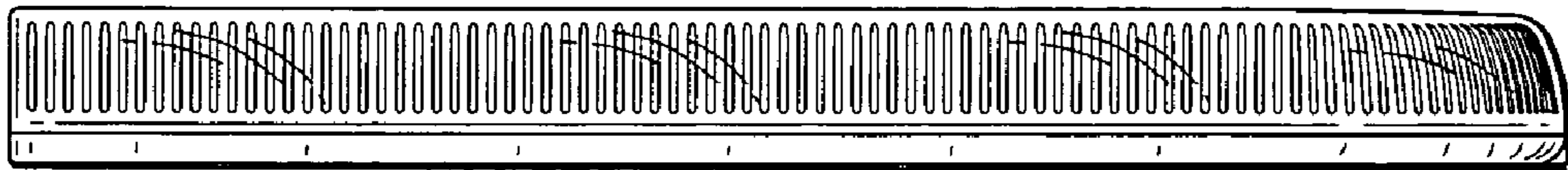

FIG. 4

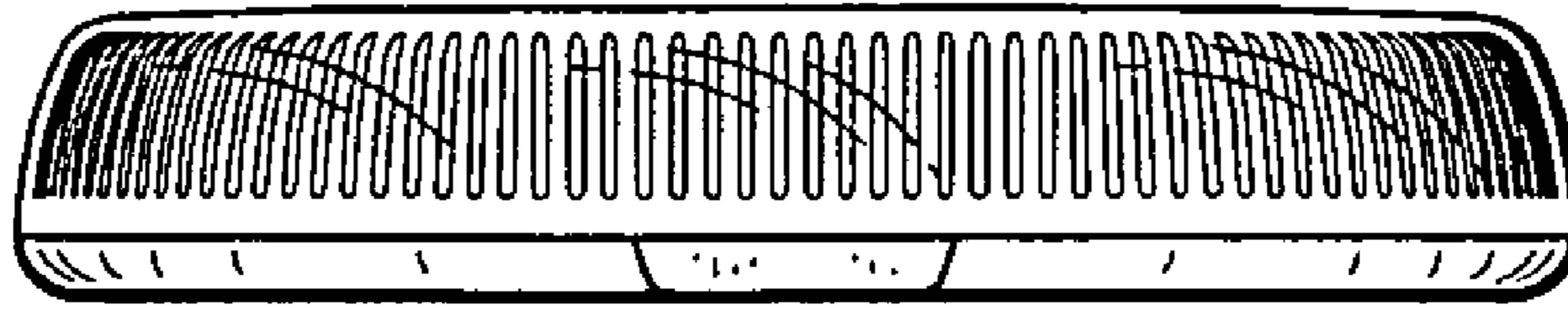

FIG. 5

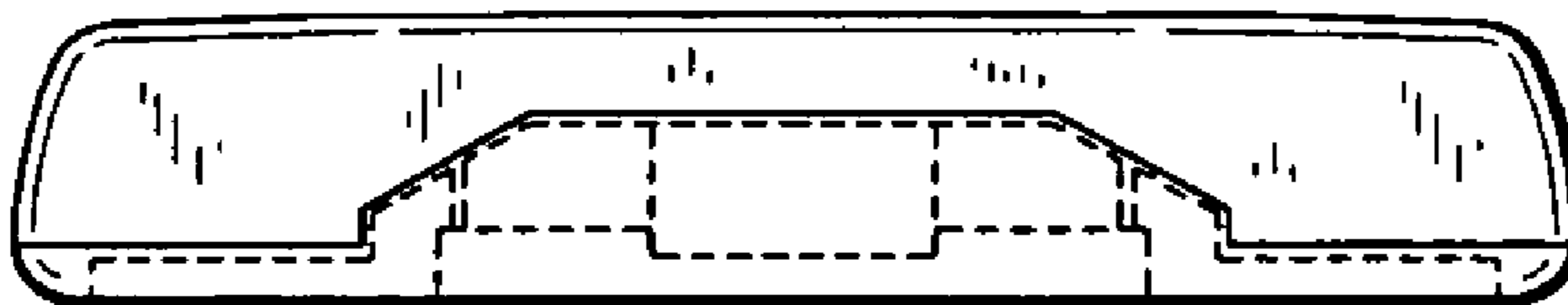

FIG. 6

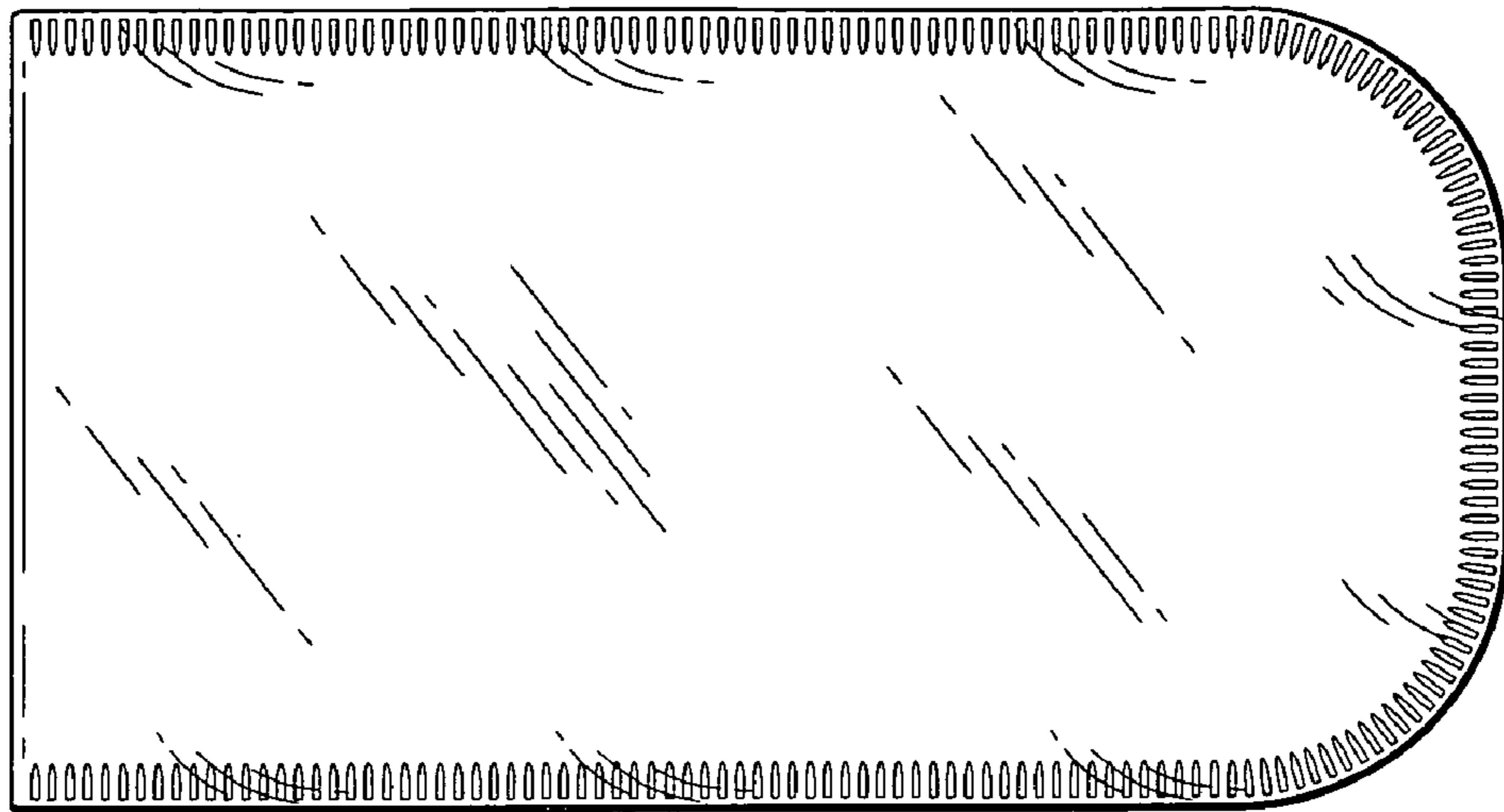

FIG. 7

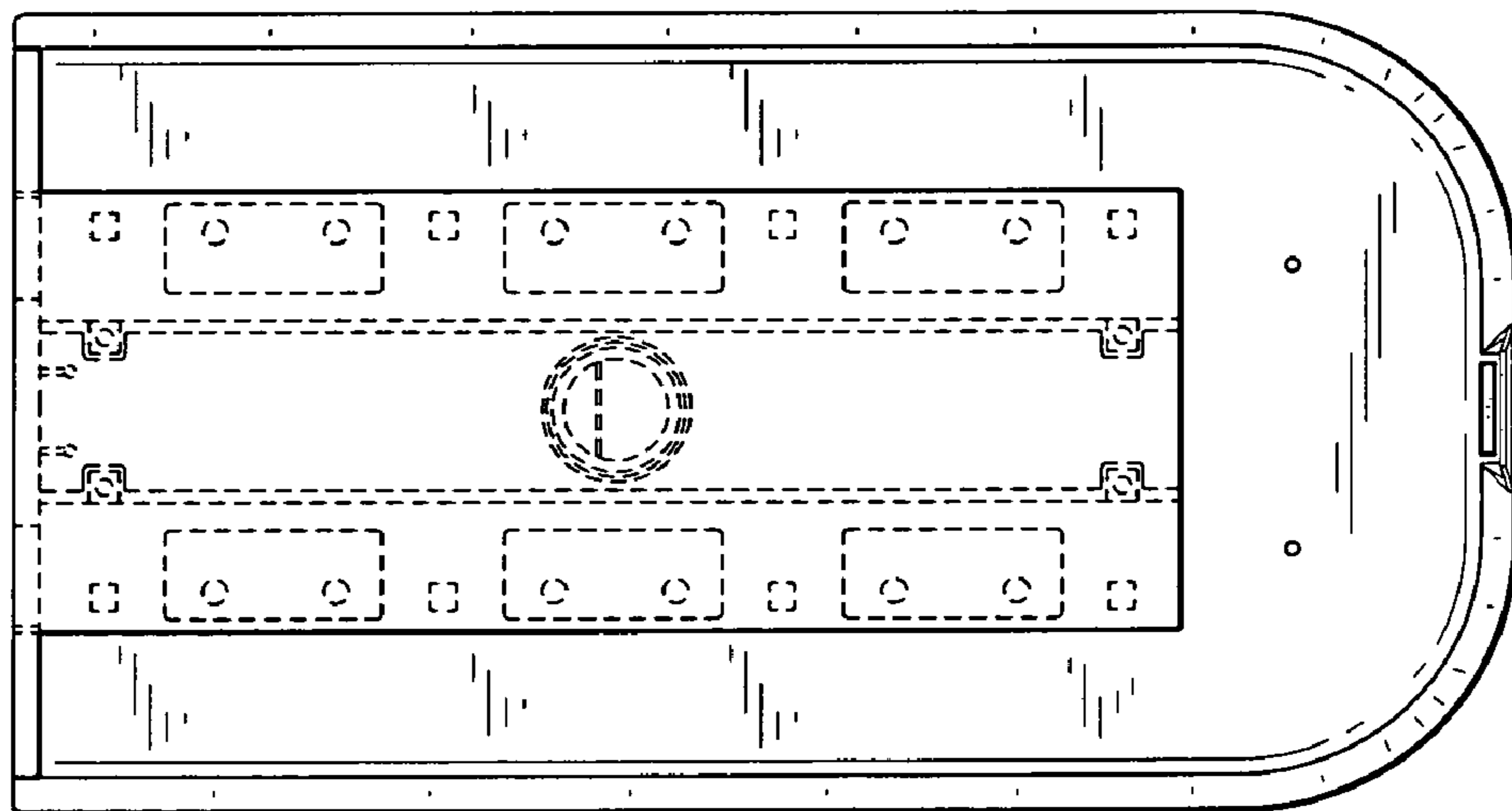

FIG. 8

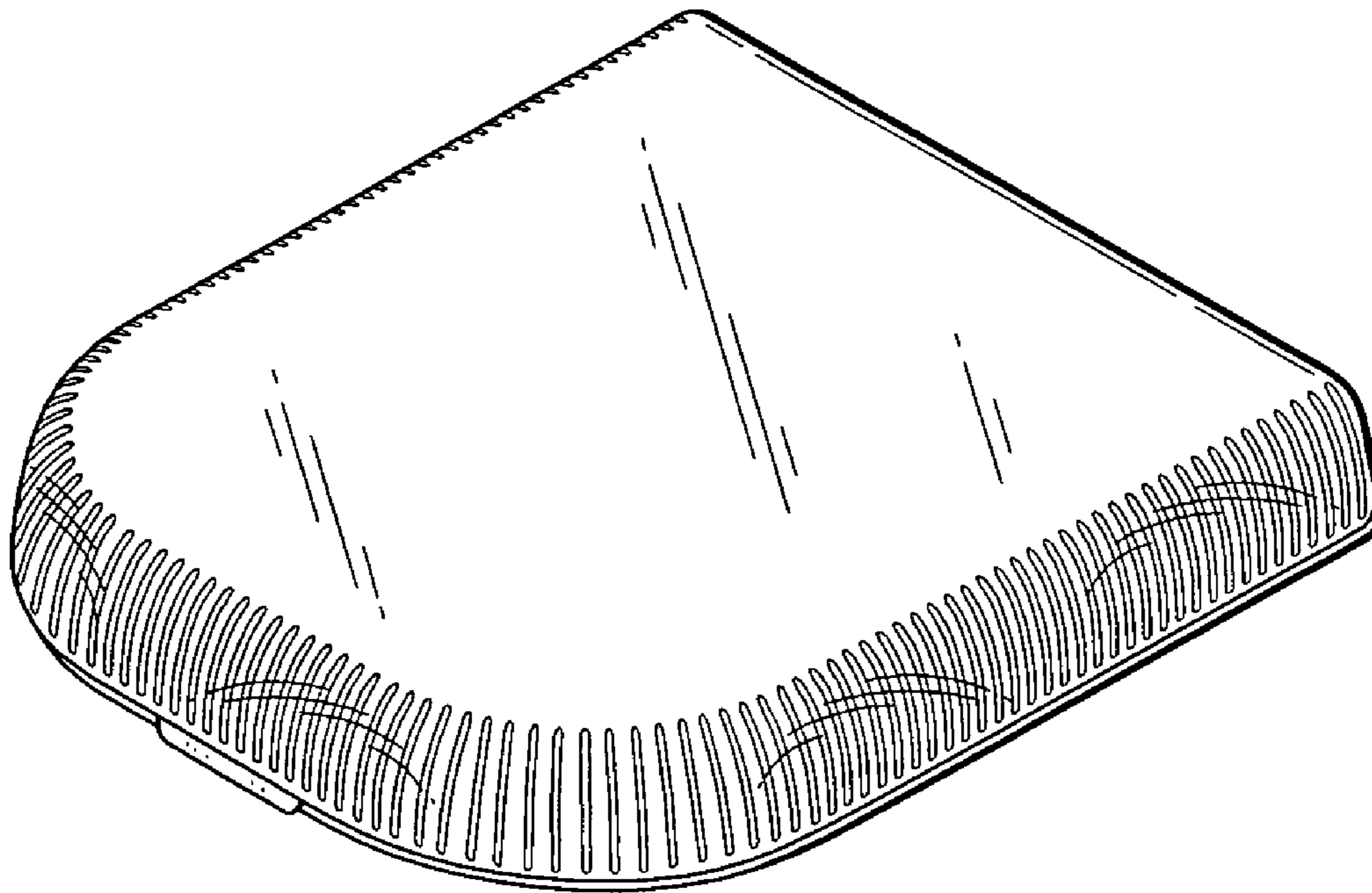

FIG. 9

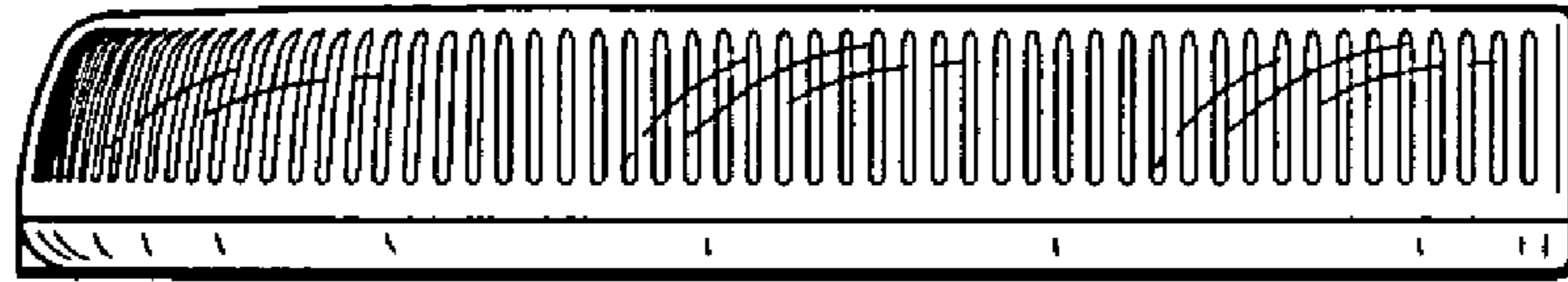

FIG. 10

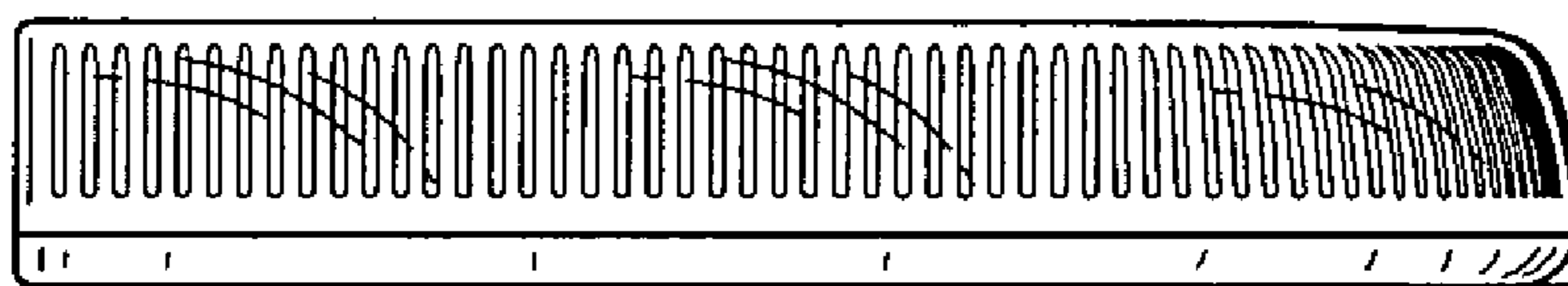

FIG. 11

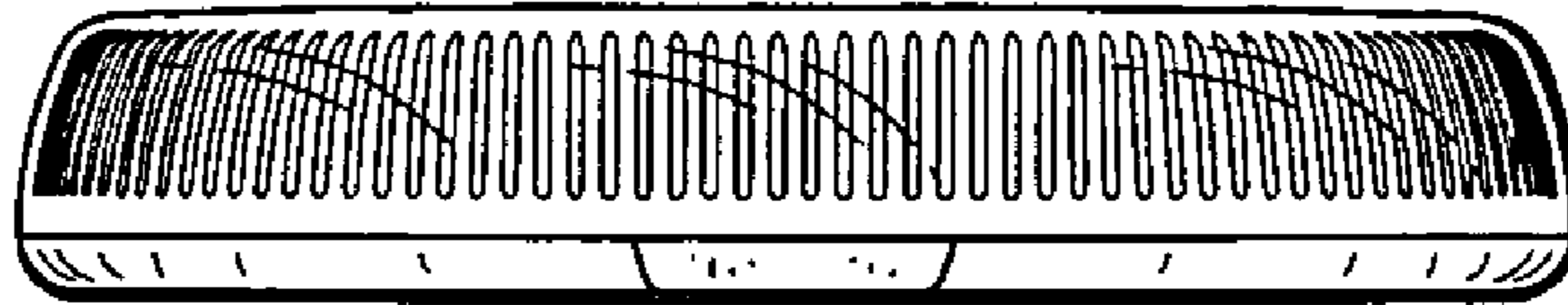

FIG. 12

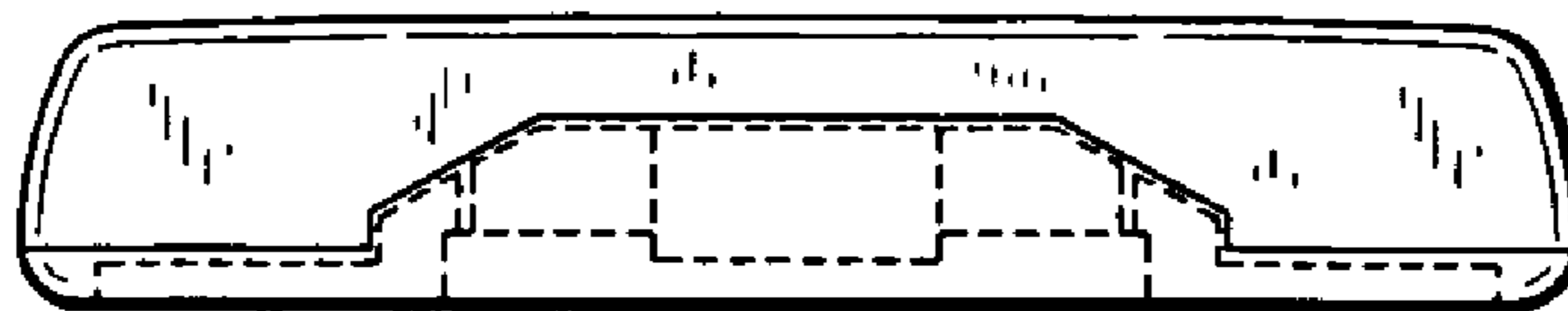

FIG. 13

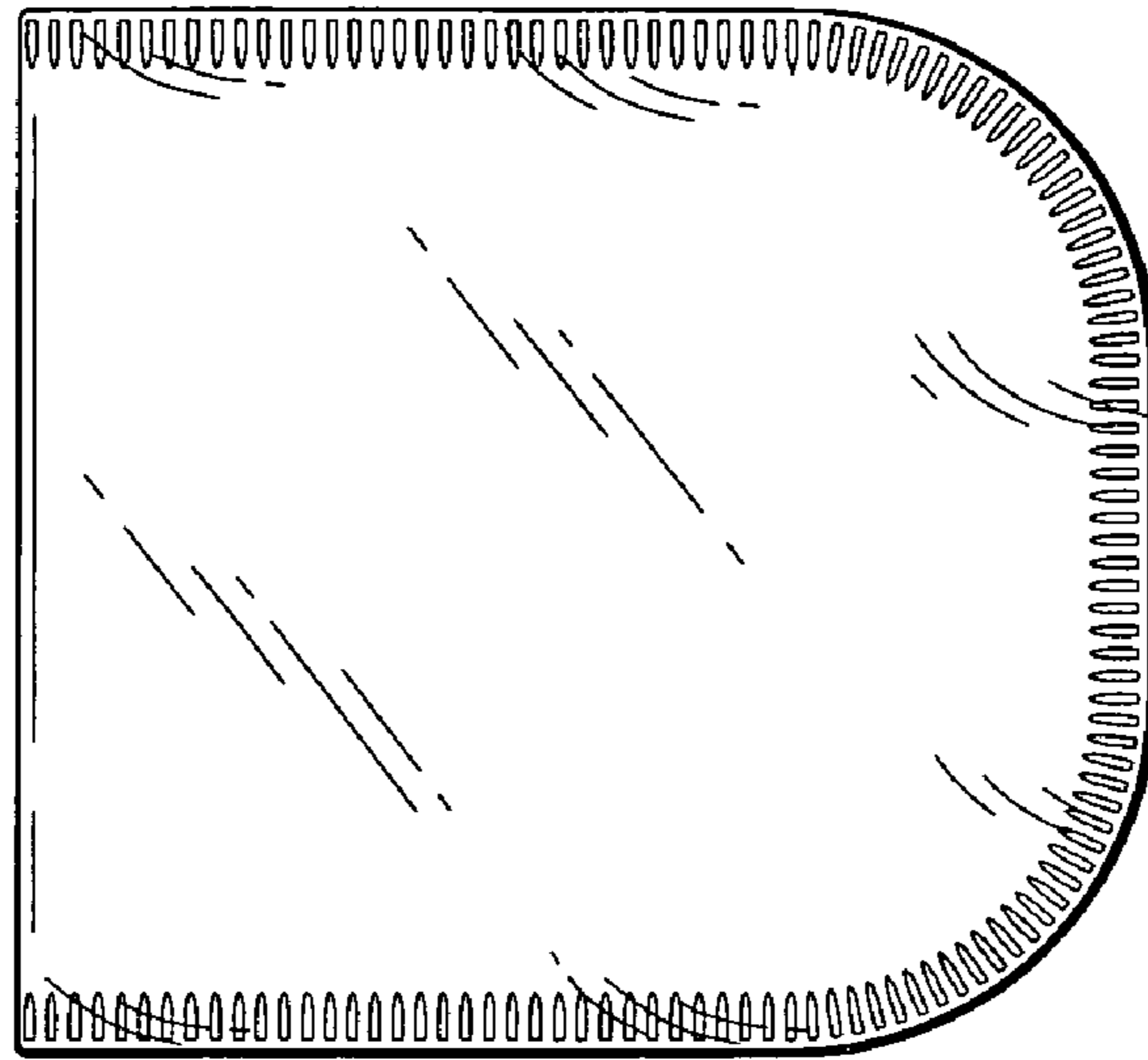

FIG. 14

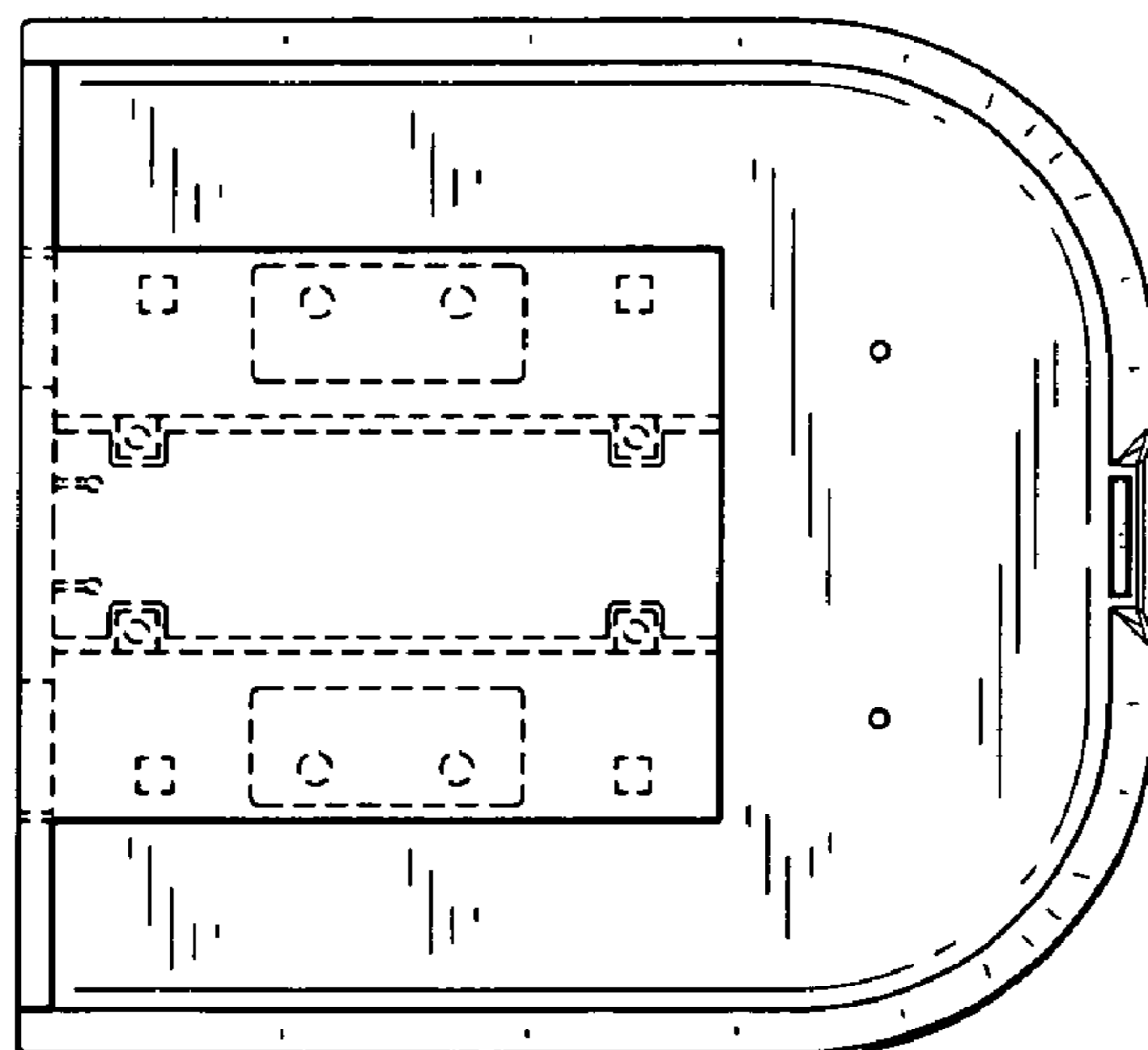

FIG. 15

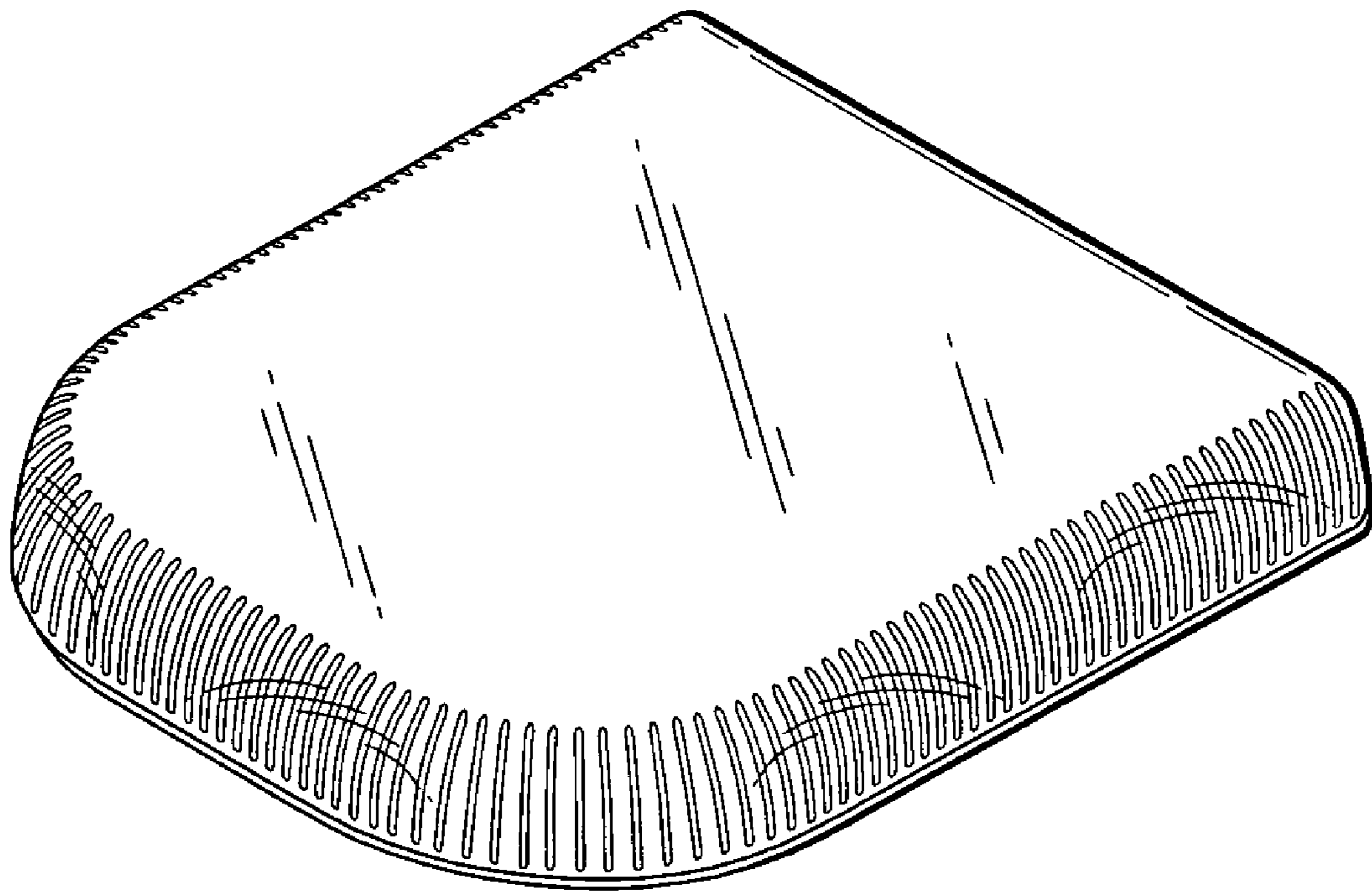

FIG. 16

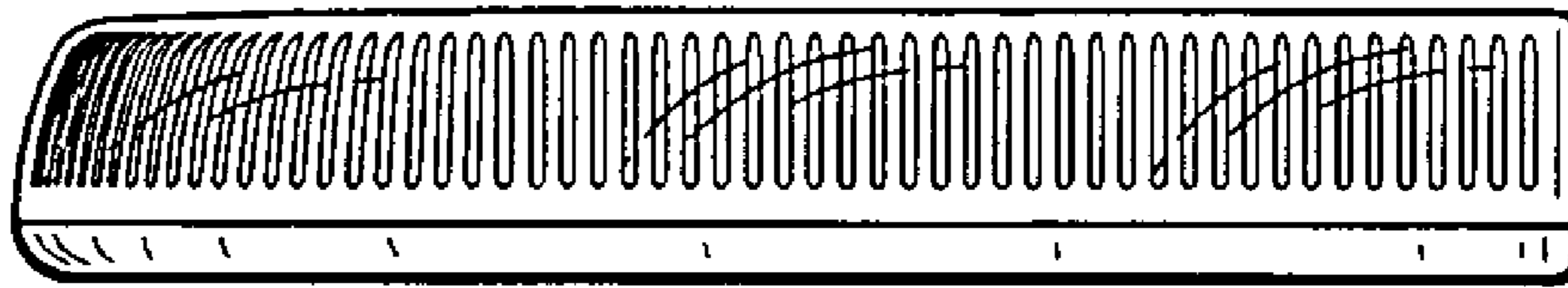

FIG. 17

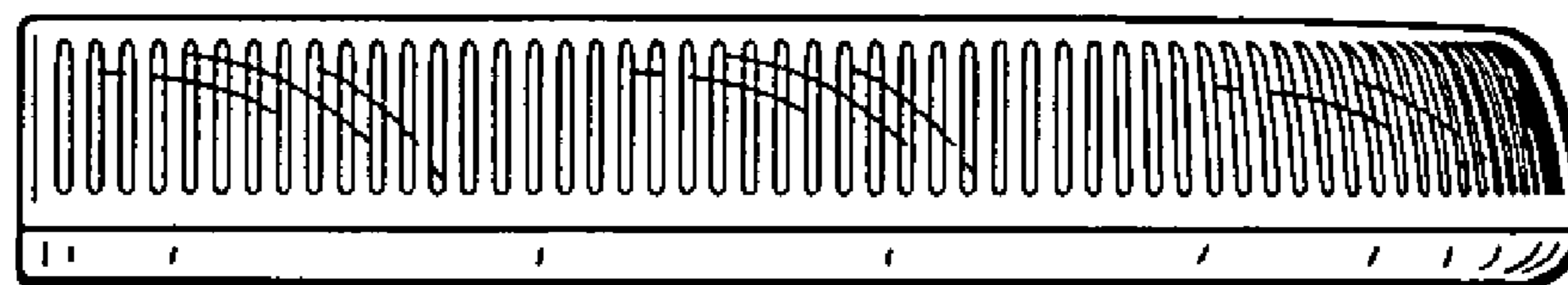

FIG. 18

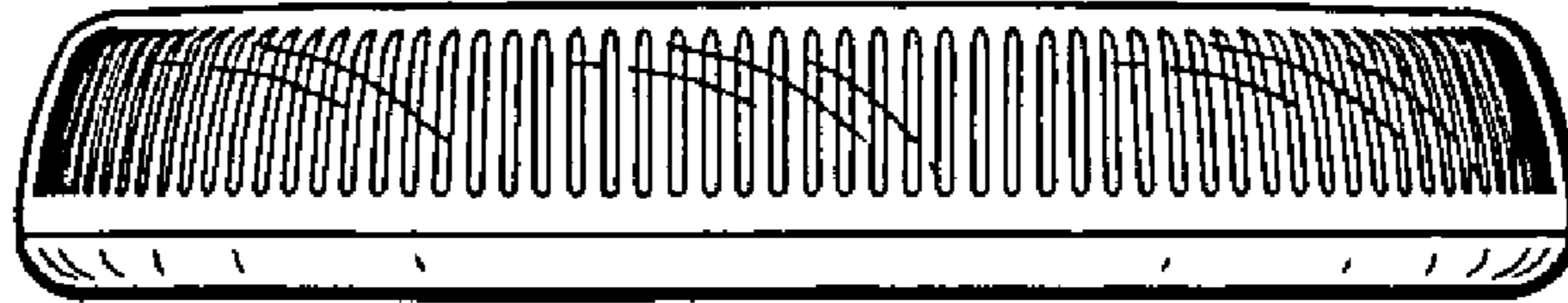

FIG. 19

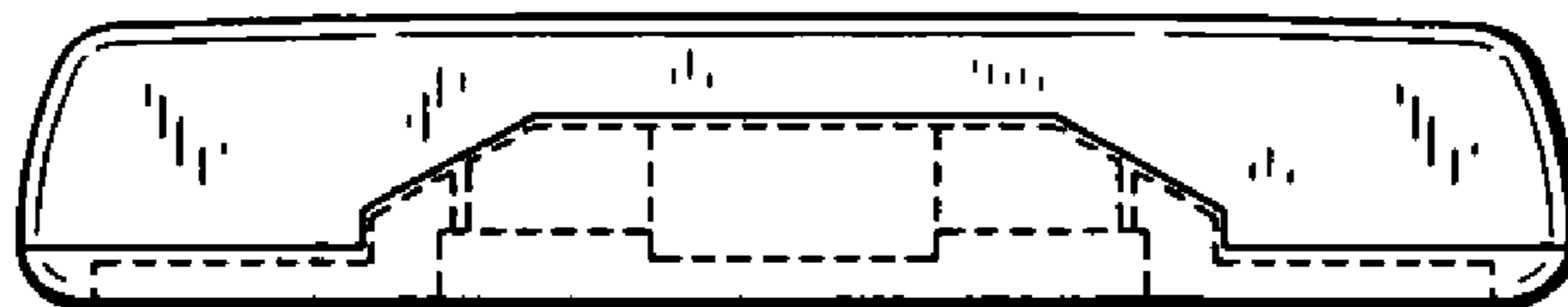

FIG. 20

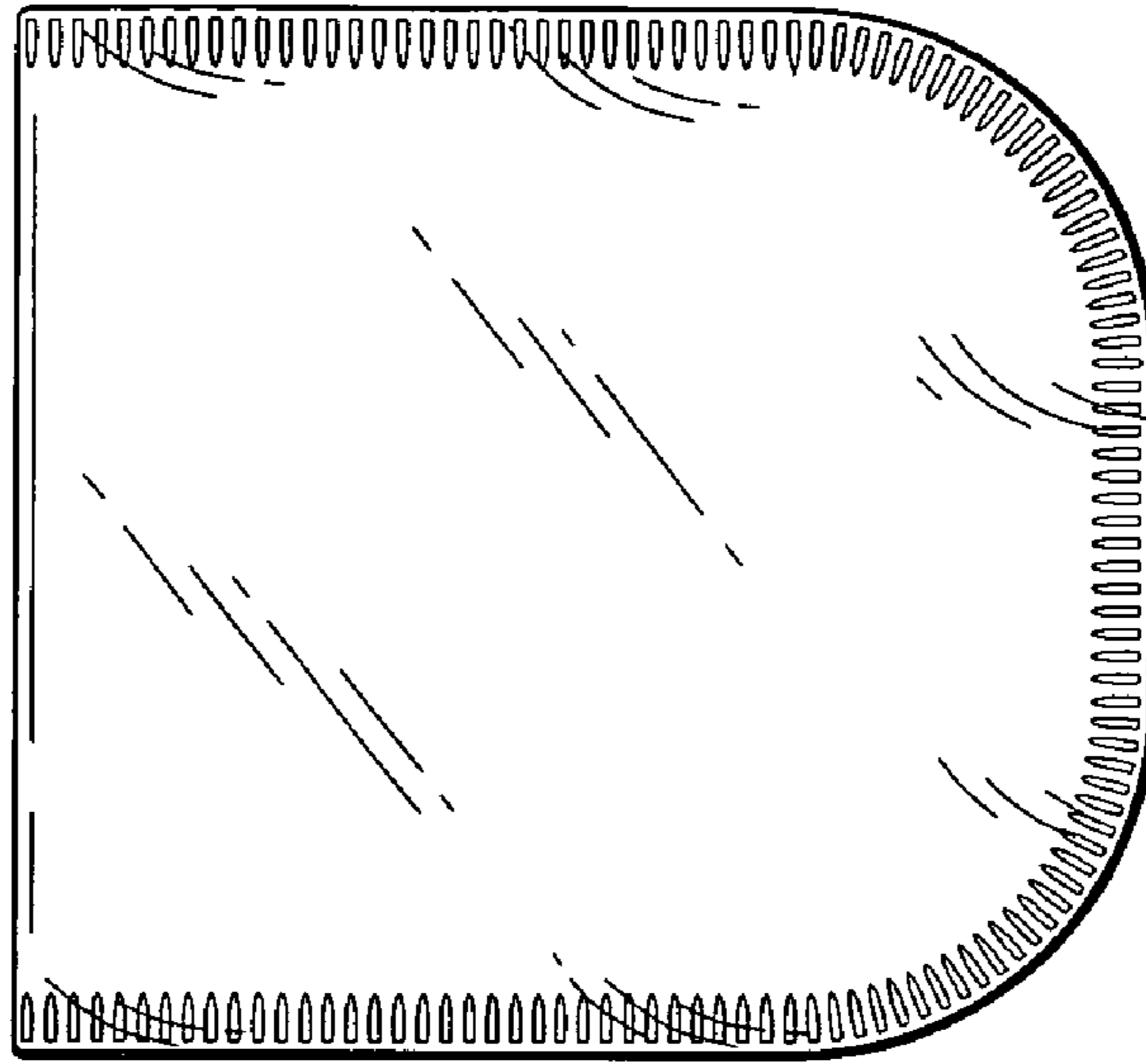

FIG. 21

