

US00D593395S

(12) **United States Design Patent**  
**Jones et al.**

(10) **Patent No.:** **US D593,395 S**  
(45) **Date of Patent:** **\*\* Jun. 2, 2009**

(54) **DOOR HANDLE PULL AND ESCUTCHEON**

(75) Inventors: **Sherry L. Jones**, Pataskala, OH (US);  
**Kevin J. Vititoe**, Columbus, OH (US)

(73) Assignee: **Truth Hardware Corporation**,  
Owatonna, MI (US)

(\*\*) Term: **14 Years**

(21) Appl. No.: **29/279,292**

(22) Filed: **Apr. 25, 2007**

(51) **LOC (9) Cl.** ..... **08-06**

(52) **U.S. Cl.** ..... **D8/302; D8/301**

(58) **Field of Classification Search** ..... D8/300–303,  
D8/305–321, DIG. 1, DIG. 2, DIG. 10, 350,  
D8/353; D7/393, 394, 405; D3/318; D6/549,  
D6/524, 533, 550; D23/250–254, 303, 305;  
D15/89; 292/347, 336.3, 36, 65; 211/16,  
211/182; 220/752–754; 16/441, 118, 110 R,  
16/111 R, DIG. 19, DIG. 30, 110.1, 412,  
16/414–420, 443–446; 70/95–100

See application file for complete search history.

(56) **References Cited**

**U.S. PATENT DOCUMENTS**

D72,725 S	5/1927	Rosenthal	
D176,085 S	11/1955	Stone	
D196,563 S	10/1963	Clayton	
D199,612 S	11/1964	Foster	
3,381,990 A *	5/1968	Kreger	292/62
D261,726 S *	11/1981	Valli	D8/301
D270,994 S *	10/1983	Tegner	D8/316
D297,505 S	9/1988	Mosch	
D316,807 S	5/1991	Paulson et al.	
D320,334 S *	10/1991	Clancy	D8/301
D330,839 S *	11/1992	Barrington et al.	D8/315
5,210,905 A *	5/1993	Dietz et al.	16/429
D340,398 S *	10/1993	Clancy	D8/302
D350,890 S *	9/1994	Boeri	D8/302
D351,980 S *	11/1994	Molteni	D8/302
D370,167 S *	5/1996	Edwards	D8/320
D384,266 S *	9/1997	Mantarakis et al.	D8/301

D384,568 S *	10/1997	Mantarakis et al.	D8/301
D384,573 S *	10/1997	Lee	D8/318
D389,722 S *	1/1998	Blom	D8/319
D397,604 S *	9/1998	Libby et al.	D8/301
D417,831 S *	12/1999	Libby et al.	D8/302
6,023,952 A *	2/2000	Mantarakis et al.	70/99
D423,321 S *	4/2000	Maier	D8/302
D427,878 S *	7/2000	Frey	D8/302
D431,994 S *	10/2000	Libby et al.	D8/301
D433,916 S *	11/2000	Frey	D8/302
D447,927 S *	9/2001	LaPlume et al.	D8/302
D448,647 S *	10/2001	Goldsbury	D8/319
D452,130 S *	12/2001	Richardson	D8/319
D466,787 S *	12/2002	Clancy	D8/301
D467,784 S *	12/2002	Maier	D8/301
D470,389 S *	2/2003	Richardson	D8/319
D482,592 S *	11/2003	Thuma	D8/315
6,641,186 B2 *	11/2003	Tsai	292/357
D500,242 S *	12/2004	Keller et al.	D8/318
D501,392 S *	2/2005	Roberts et al.	D8/315
D509,420 S *	9/2005	Hauber	D8/300
6,945,572 B1 *	9/2005	Hauber	292/97
D511,670 S *	11/2005	Chen	D8/301
D514,423 S *	2/2006	Timothy	D8/300
D517,395 S *	3/2006	Alchin	D8/330
D521,351 S *	5/2006	Alchin	D8/301
D523,725 S *	6/2006	Chen	D8/301
D531,482 S *	11/2006	Chen	D8/302
D546,160 S *	7/2007	Reithmeyer	D8/301
D551,534 S *	9/2007	Liang et al.	D8/301
D572,996 S *	7/2008	Nolte et al.	D8/302

\* cited by examiner

*Primary Examiner*—Stella M Reid

*Assistant Examiner*—Mark A Goodwin

(74) *Attorney, Agent, or Firm*—Patterson, Thunte, Skaar & Christensen, P.A.

(57) **CLAIM**

We claim the ornamental design for door handle pull and escutcheon, as shown and described.

**DESCRIPTION**

FIG. 1 is a front perspective view of a door handle pull and escutcheon according to a first embodiment of the invention;

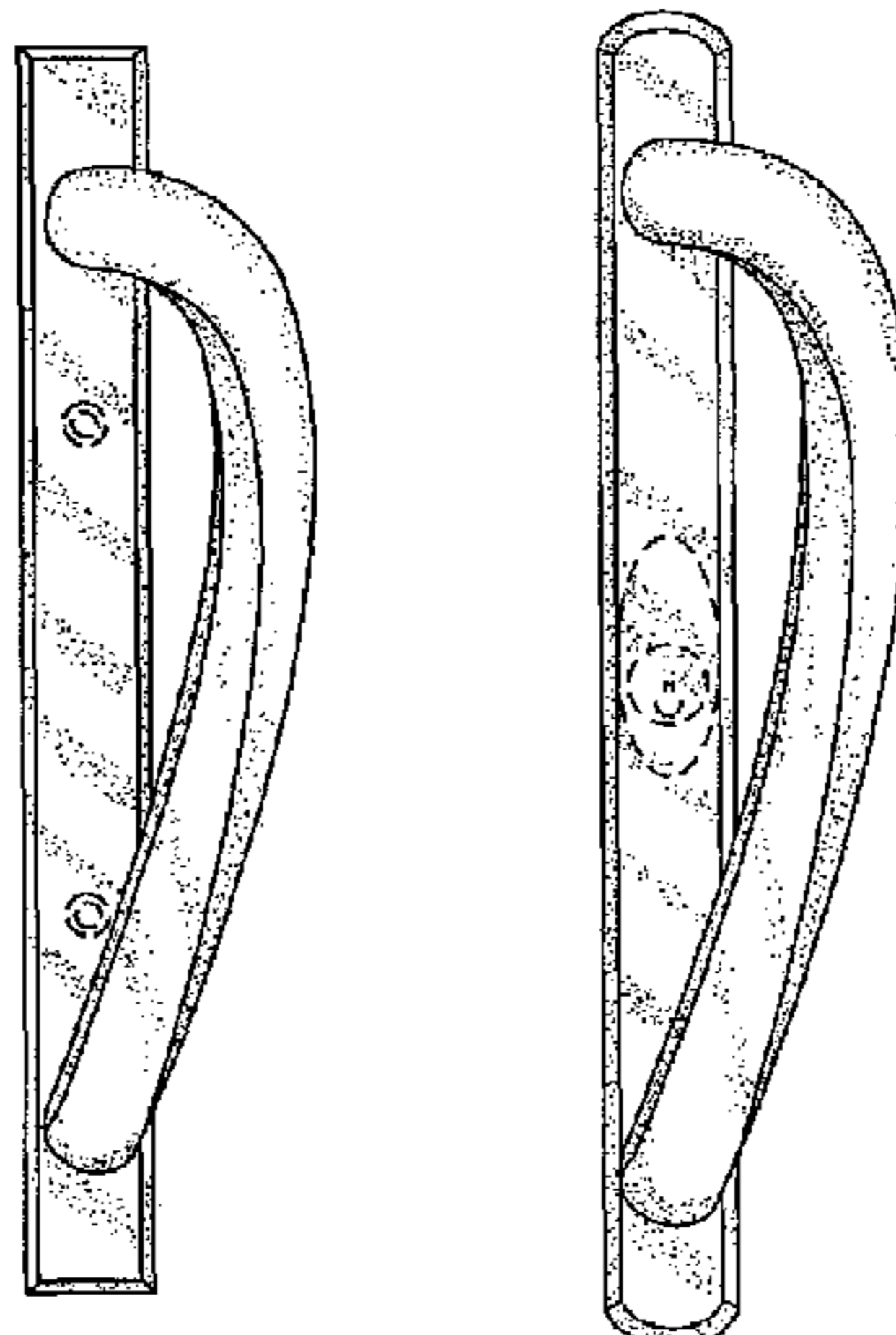


FIG. 2 is a front elevation view of the door handle pull and escutcheon depicted in FIG. 1;

FIG. 3 is a side elevation view of the door handle pull and escutcheon depicted in FIG. 1;

FIG. 4 is an opposing side elevation view of the door handle pull and escutcheon depicted in FIG. 1;

FIG. 5 is a rear elevation view of the door handle pull and escutcheon depicted in FIG. 1;

FIG. 6 is a top plan view of the door handle pull and escutcheon depicted in FIG. 1;

FIG. 7 is a bottom plan view of the door handle pull and escutcheon depicted in FIG. 1;

FIG. 8 is a front perspective view of a door handle pull and escutcheon according to a second embodiment of the invention;

FIG. 9 is a front elevation view of the door handle pull and escutcheon depicted in FIG. 8;

FIG. 10 is a side elevation view of the door handle pull and escutcheon depicted in FIG. 8;

FIG. 11 is an opposing side elevation view of the door handle pull and escutcheon depicted in FIG. 8;

FIG. 12 is a rear elevation view of the door handle pull and escutcheon depicted in FIG. 8;

FIG. 13 is a top plan view of the door handle pull and escutcheon depicted in FIG. 8;

FIG. 14 is a bottom plan view of the door handle pull and escutcheon depicted in FIG. 8;

FIG. 15 is a front elevation view of a door handle pull and escutcheon according to a third embodiment of the invention;

FIG. 16 is a side elevation view of the door handle pull and escutcheon depicted in FIG. 15;

FIG. 17 is an opposing side elevation view of the door handle pull and escutcheon depicted in FIG. 15;

FIG. 18 is a rear elevation view of the door handle pull and escutcheon depicted in FIG. 15;

FIG. 19 is a top plan view of the door handle pull and escutcheon depicted in FIG. 15;

FIG. 20 is a bottom plan view of the door handle pull and escutcheon depicted in FIG. 15;

FIG. 21 is a front elevation view of a door handle pull and escutcheon according to a fourth embodiment of the invention;

FIG. 22 is a side elevation view of the door handle pull and escutcheon depicted in FIG. 21;

FIG. 23 is an opposing side elevation view of the door handle pull and escutcheon depicted in FIG. 21;

FIG. 24 is a rear elevation view of the door handle pull and escutcheon depicted in FIG. 21;

FIG. 25 is a top plan view of the door handle pull and escutcheon depicted in FIG. 21;

FIG. 26 is a bottom plan view of the door handle pull and escutcheon depicted in FIG. 21;

FIG. 27 is a front elevation view of a door handle pull and escutcheon according to a fifth embodiment of the invention;

FIG. 28 is a side elevation view of the door handle pull and escutcheon depicted in FIG. 27;

FIG. 29 is an opposing side elevation view of the door handle pull and escutcheon depicted in FIG. 27;

FIG. 30 is a rear elevation view of the door handle pull and escutcheon depicted in FIG. 27;

FIG. 31 is a top plan view of the door handle pull and escutcheon depicted in FIG. 27;

FIG. 32 is a bottom plan view of the door handle pull and escutcheon depicted in FIG. 27;

FIG. 33 is a front elevation view of a door handle pull and escutcheon according to a sixth embodiment of the invention;

FIG. 34 is a side elevation view of the door handle pull and escutcheon depicted in FIG. 33;

FIG. 35 is an opposing side elevation view of the door handle pull and escutcheon depicted in FIG. 33;

FIG. 36 is a rear elevation view of the door handle pull and escutcheon depicted in FIG. 33;

FIG. 37 is a top plan view of the door handle pull and escutcheon depicted in FIG. 33;

FIG. 38 is a bottom plan view of the door handle pull and escutcheon depicted in FIG. 33;

FIG. 39 is a front elevation view of a door handle pull and escutcheon according to a seventh embodiment of the invention;

FIG. 40 is a side elevation view of the door handle pull and escutcheon depicted in FIG. 39;

FIG. 41 is an opposing side elevation view of the door handle pull and escutcheon depicted in FIG. 39;

FIG. 42 is a rear elevation view of the door handle pull and escutcheon depicted in FIG. 39;

FIG. 43 is a top plan view of the door handle pull and escutcheon depicted in FIG. 39;

FIG. 44 is a bottom plan view of the door handle pull and escutcheon depicted in FIG. 39;

FIG. 45 is a front elevation view of a door handle pull and escutcheon according to an eighth embodiment of the invention;

FIG. 46 is a side elevation view of the door handle pull and escutcheon depicted in FIG. 45;

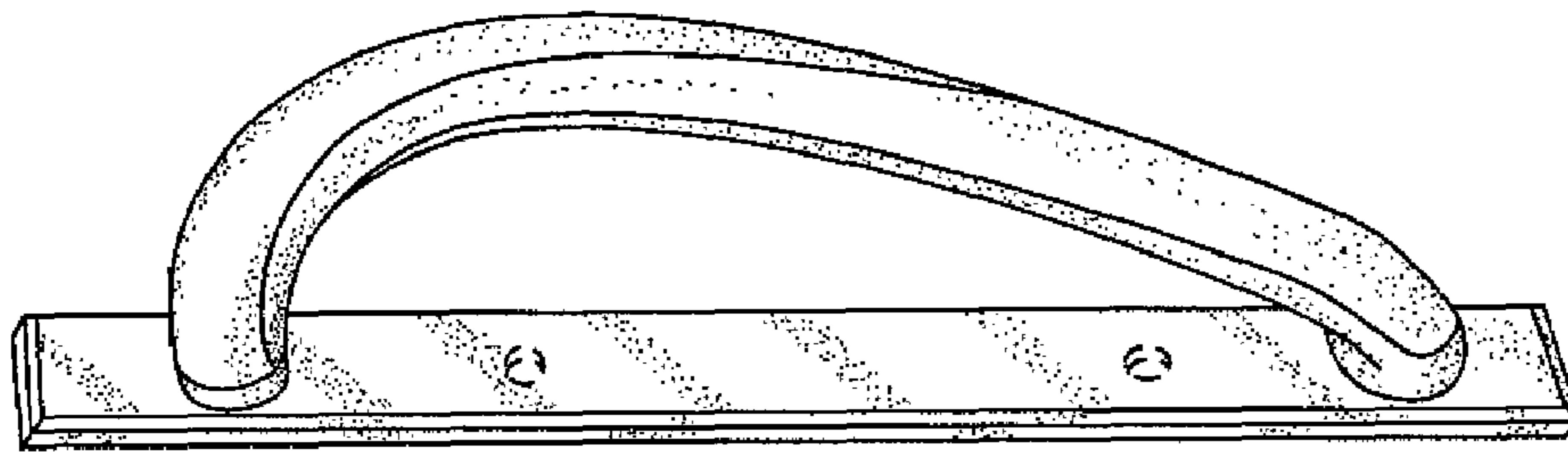
FIG. 47 is an opposing side elevation view of the door handle pull and escutcheon depicted in FIG. 45;

FIG. 48 is a rear elevation view of the door handle pull and escutcheon depicted in FIG. 45;

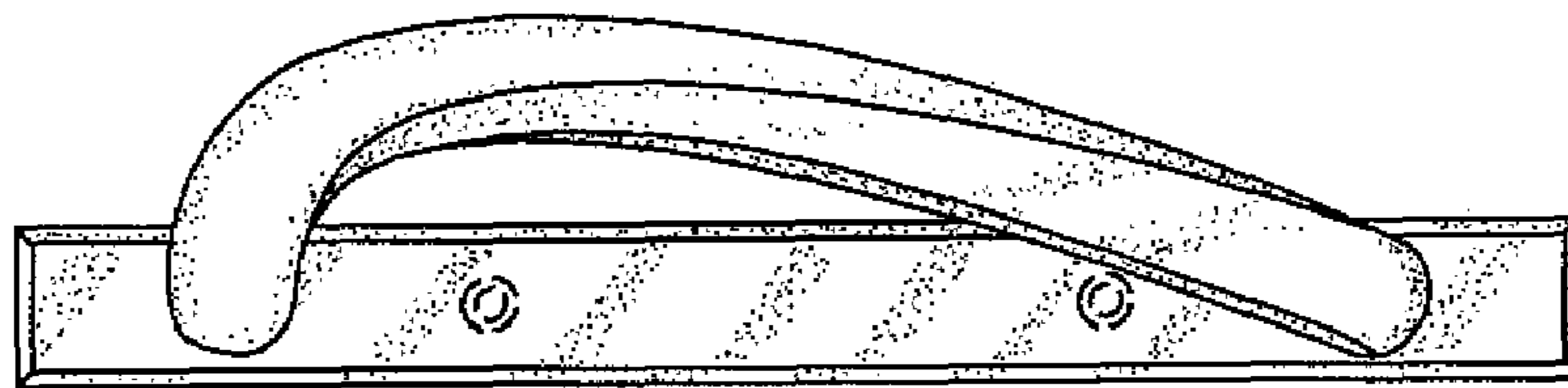
FIG. 49 is a top plan view of the door handle pull and escutcheon depicted in FIG. 45; and,

FIG. 50 is a bottom plan view of the door handle pull and escutcheon depicted in FIG. 45.

The broken line depiction of structure is included for the purpose of illustrating environment and forms no part of the claimed design.



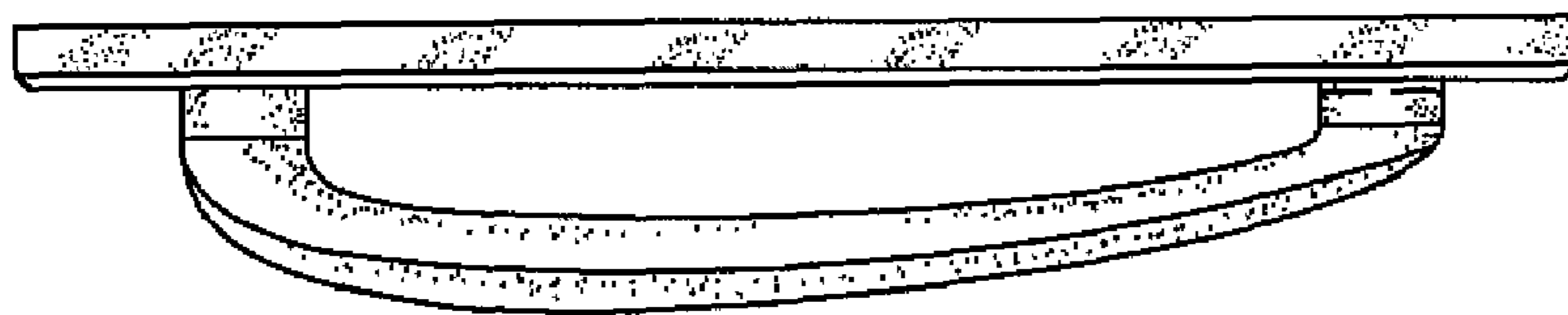
**Fig. 1**



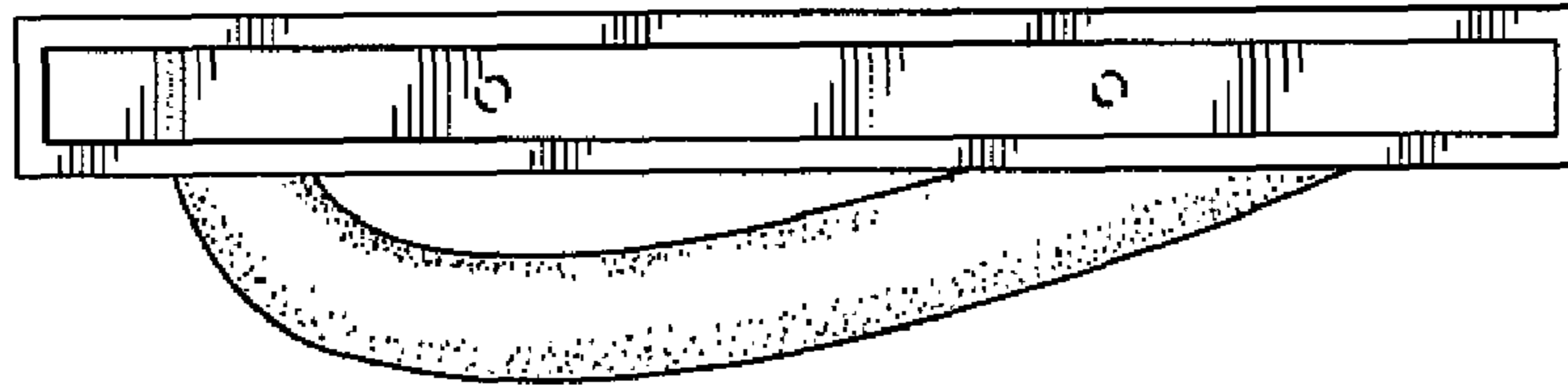
**Fig. 2**



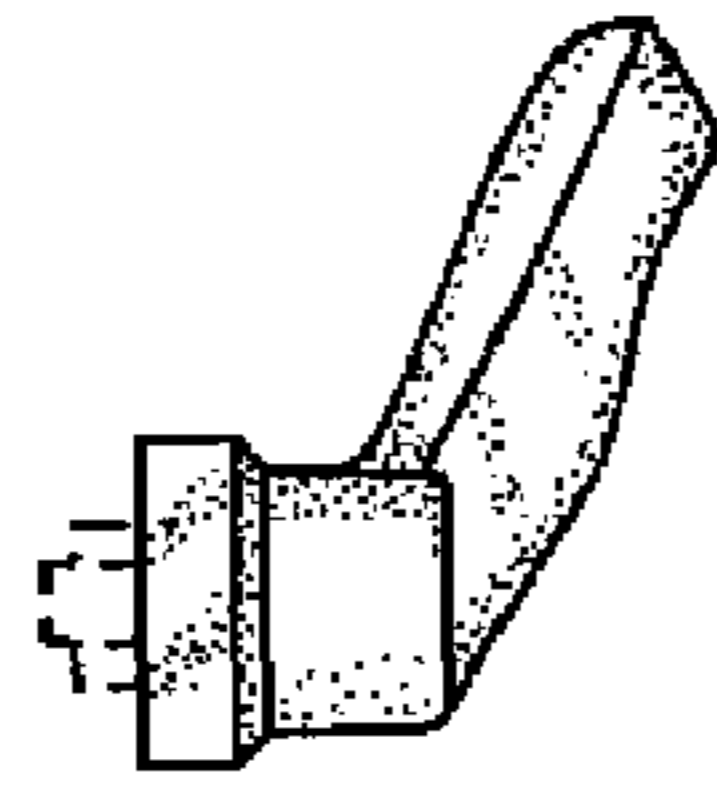
**Fig. 3**



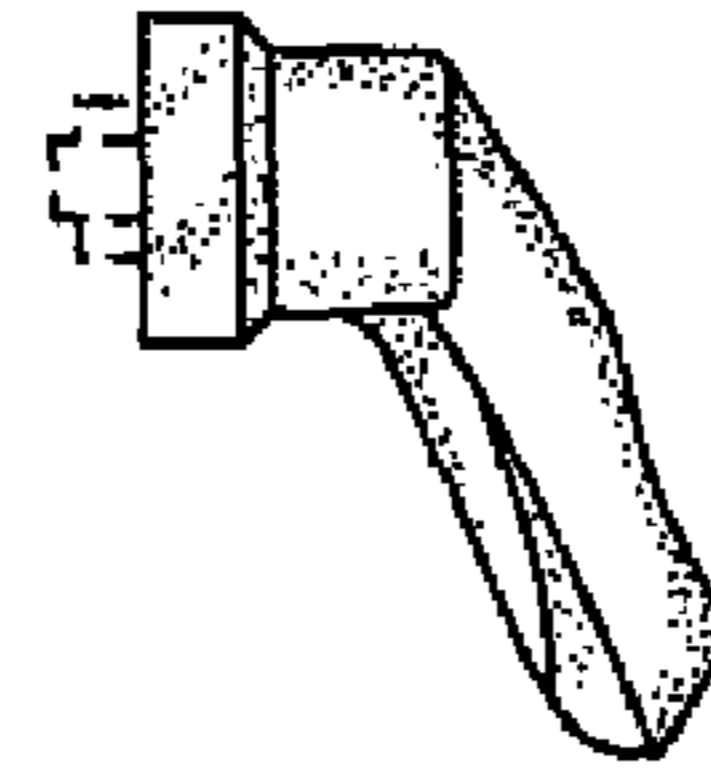
**Fig. 4**



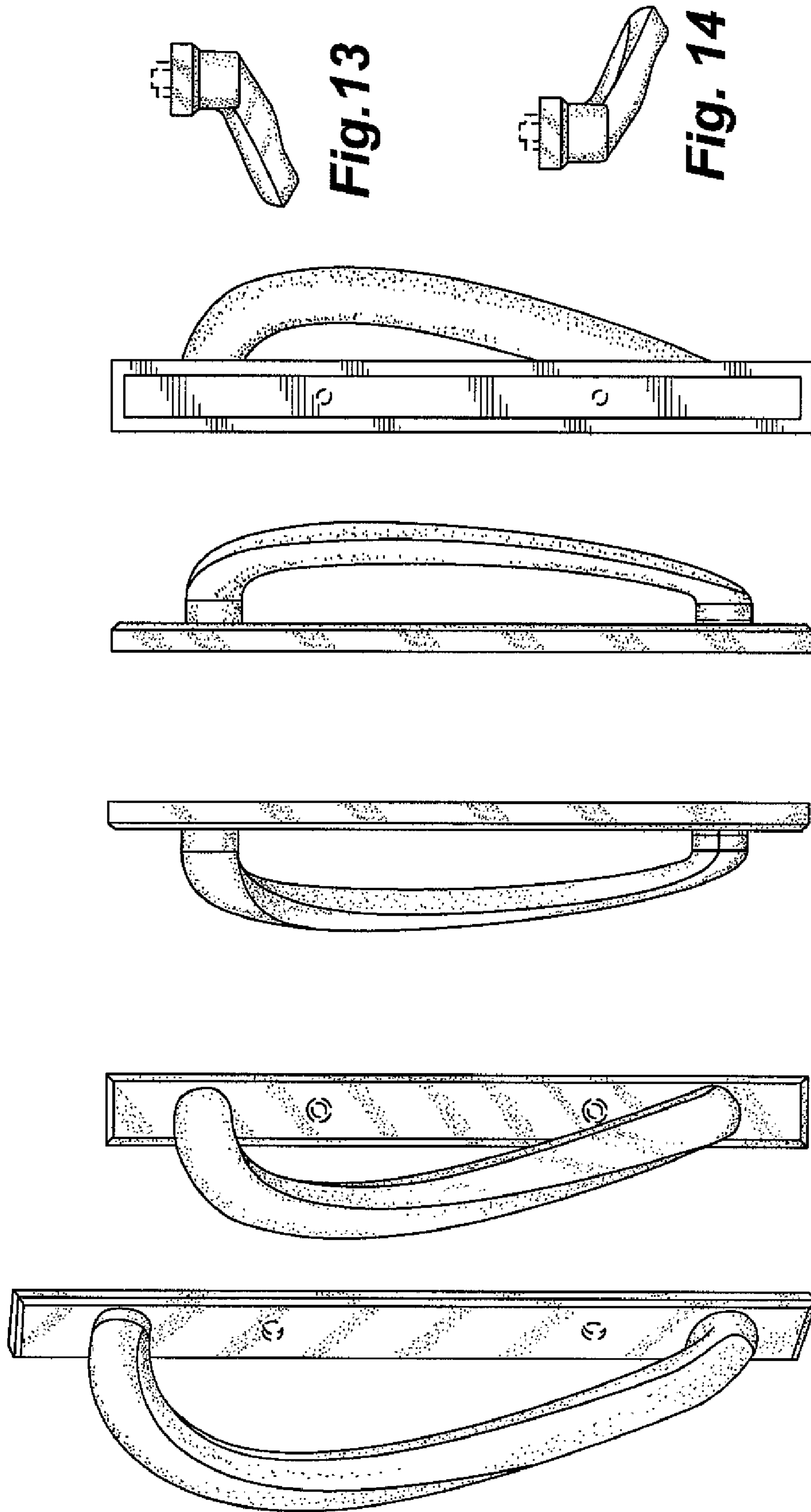
**Fig. 5**



**Fig. 6**



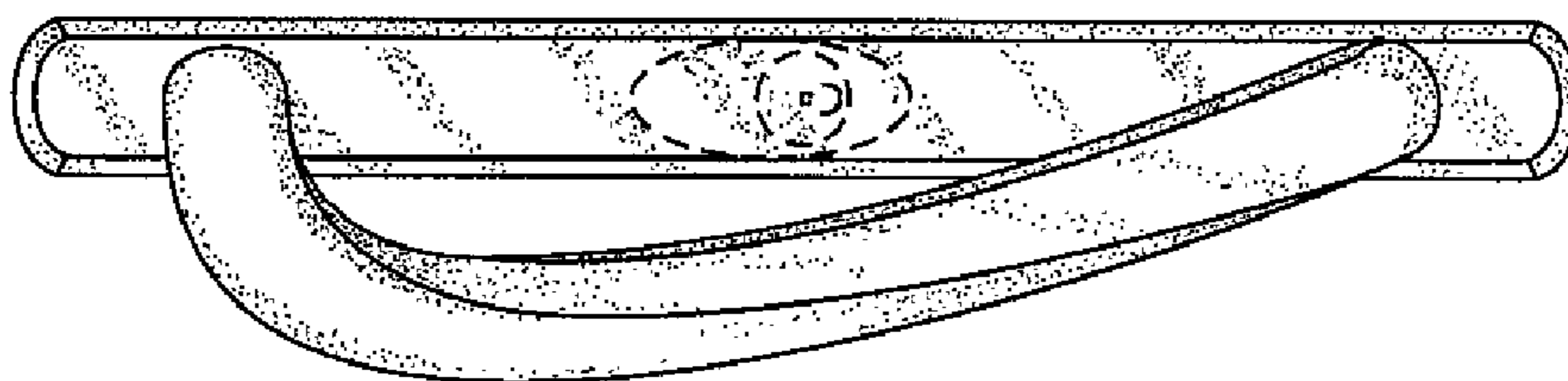
**Fig. 7**



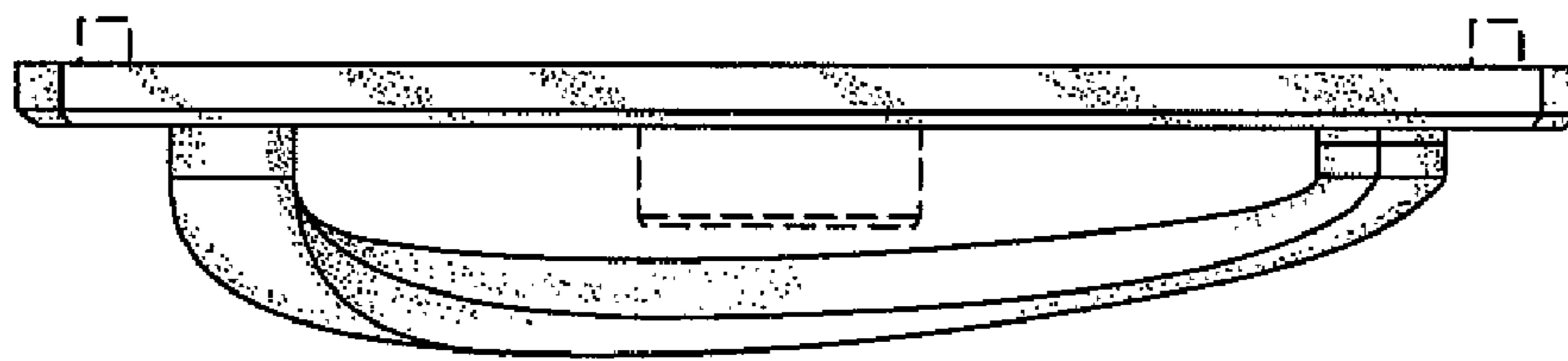
**Fig. 8 Fig. 9 Fig. 10 Fig. 11 Fig. 12**

**Fig. 13**

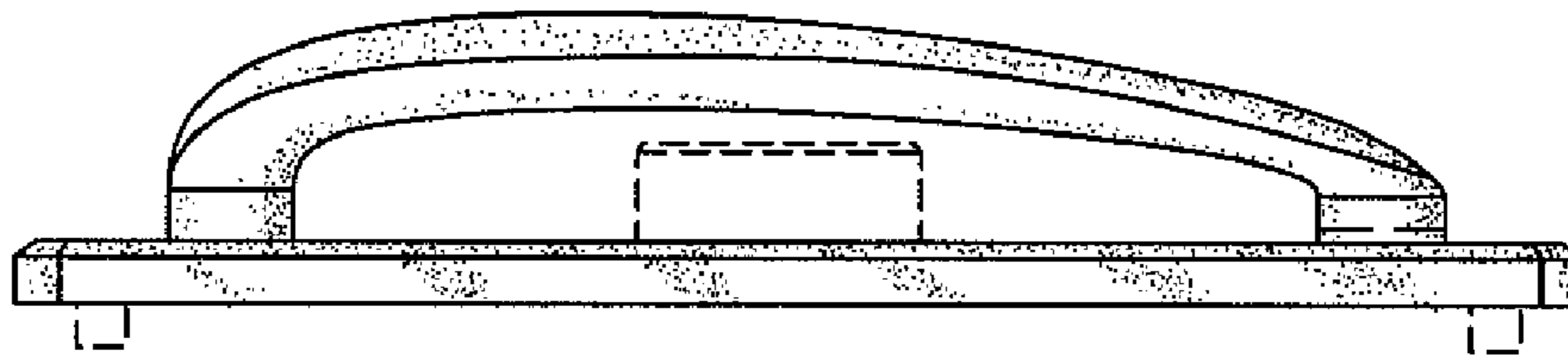
**Fig. 14**



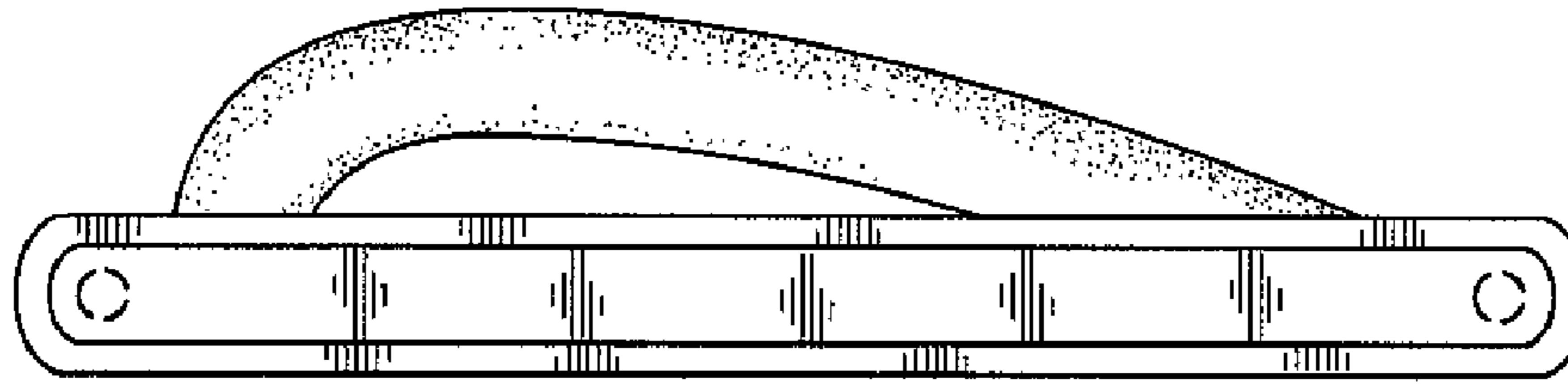
**Fig. 15**



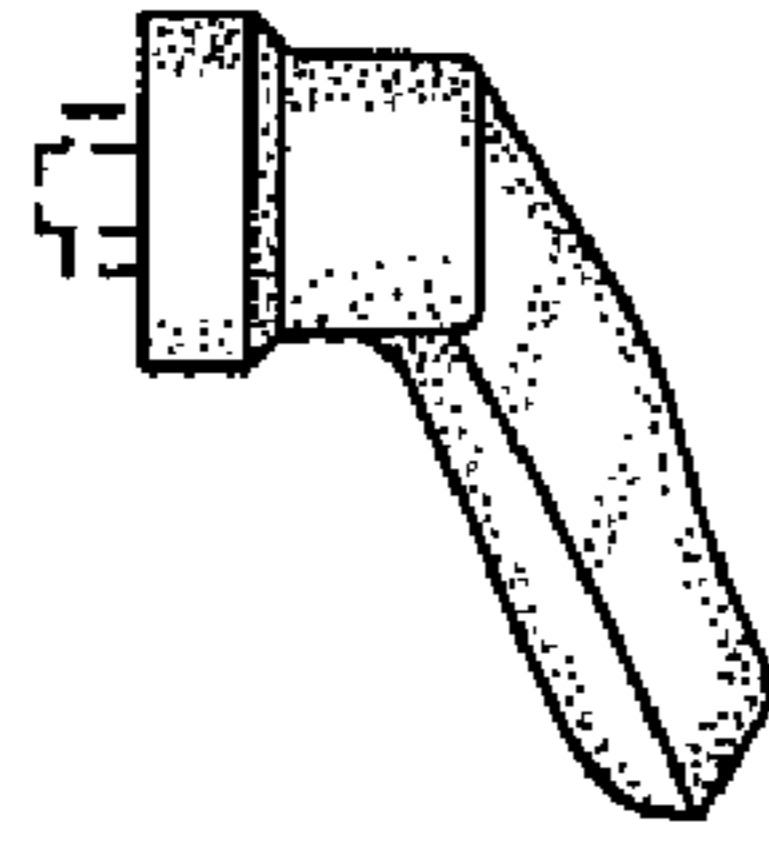
**Fig. 16**



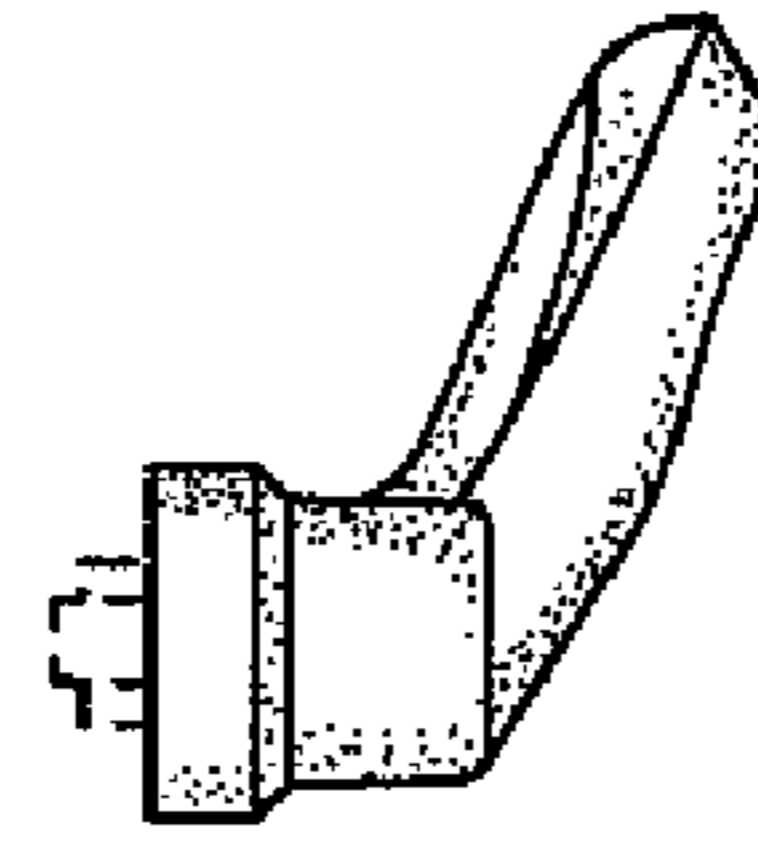
**Fig. 17**



**Fig. 18**



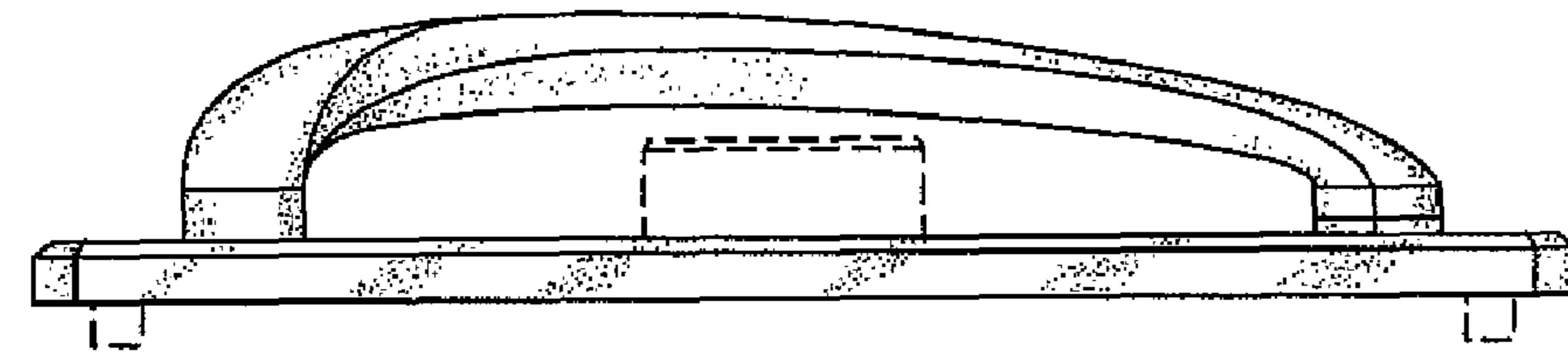
**Fig. 19**



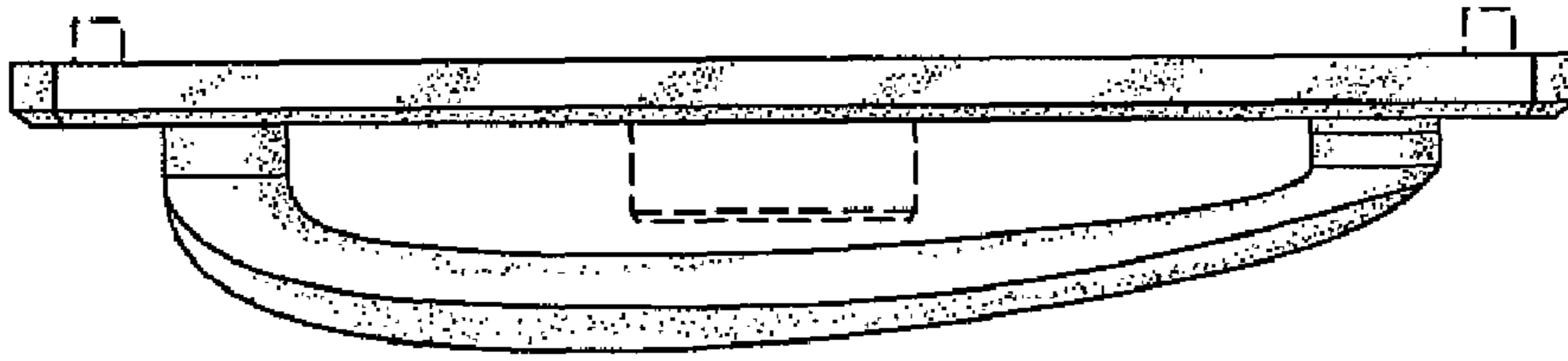
**Fig. 20**



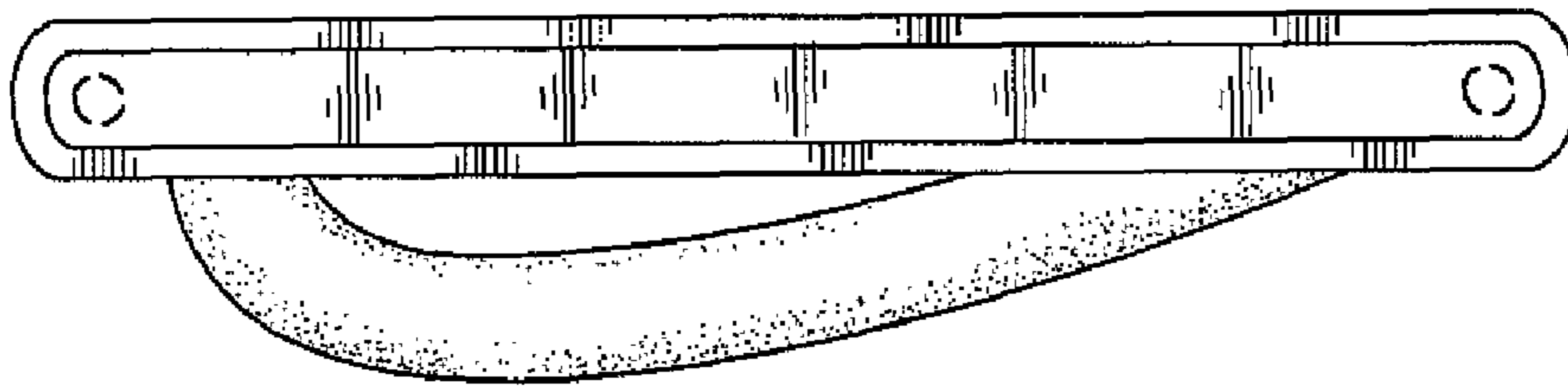
**Fig. 21**



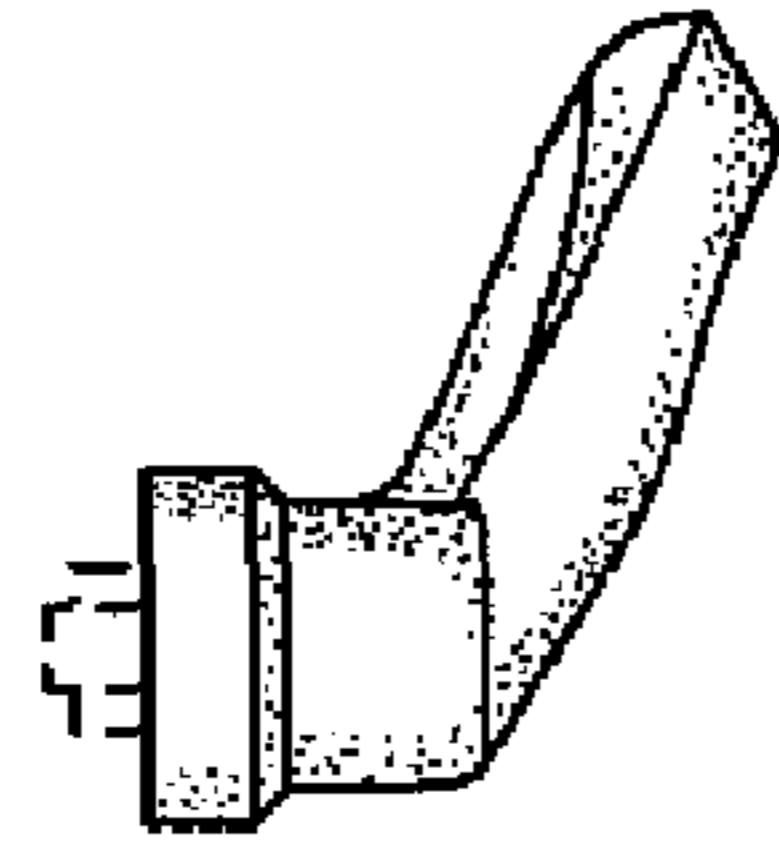
**Fig. 22**



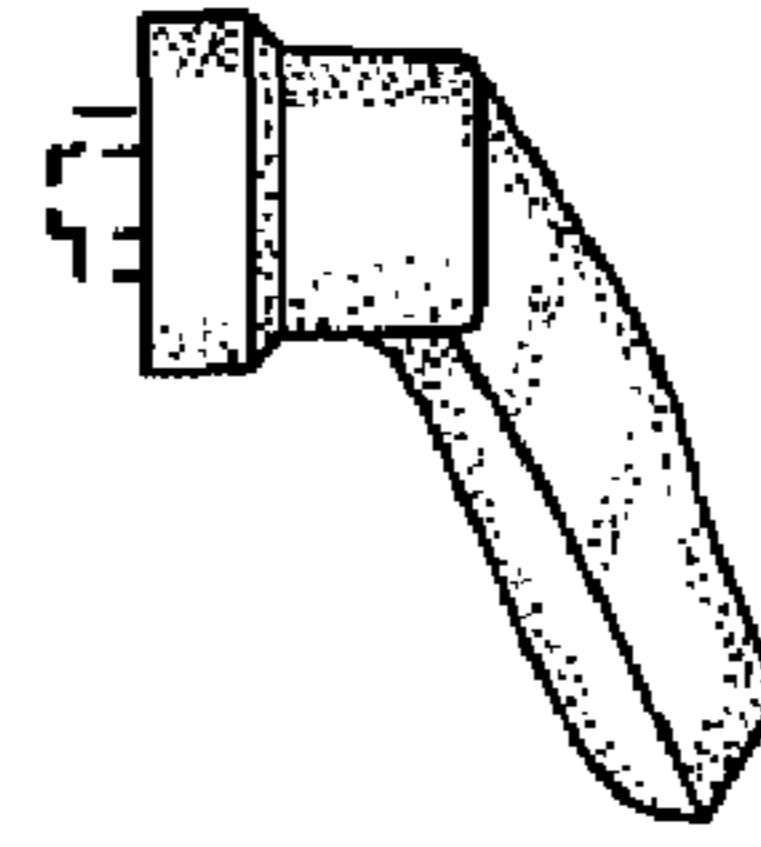
**Fig. 23**



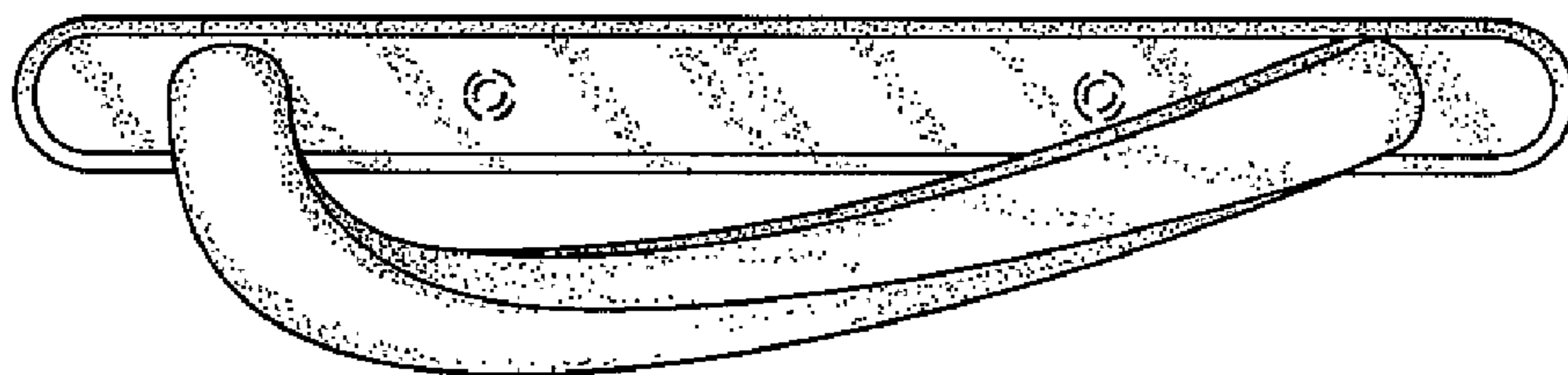
**Fig. 24**



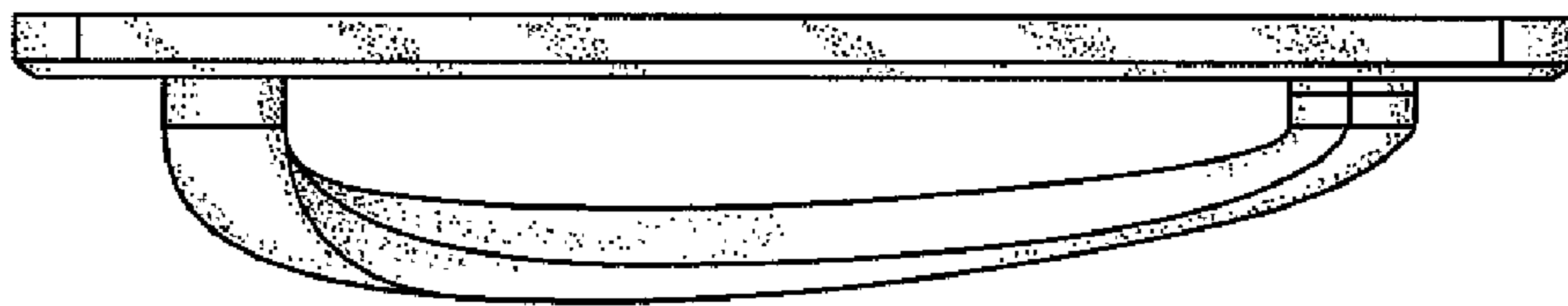
**Fig. 25**



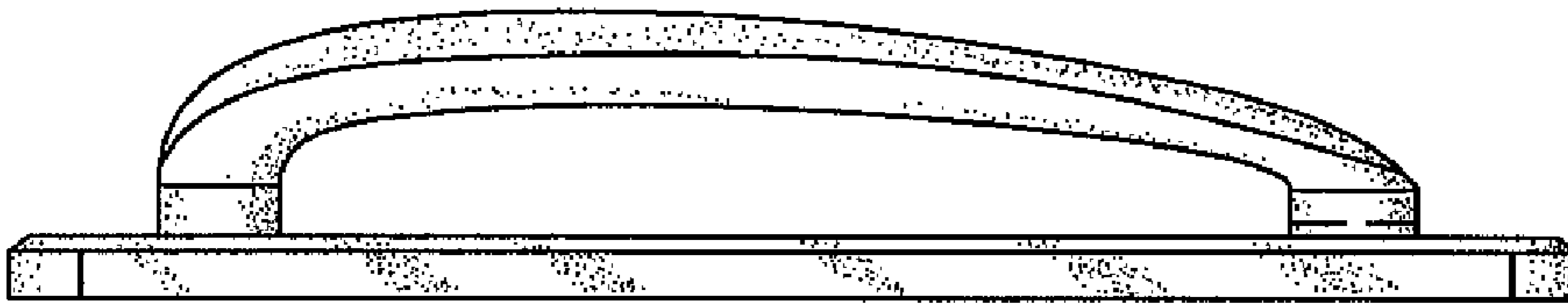
**Fig. 26**



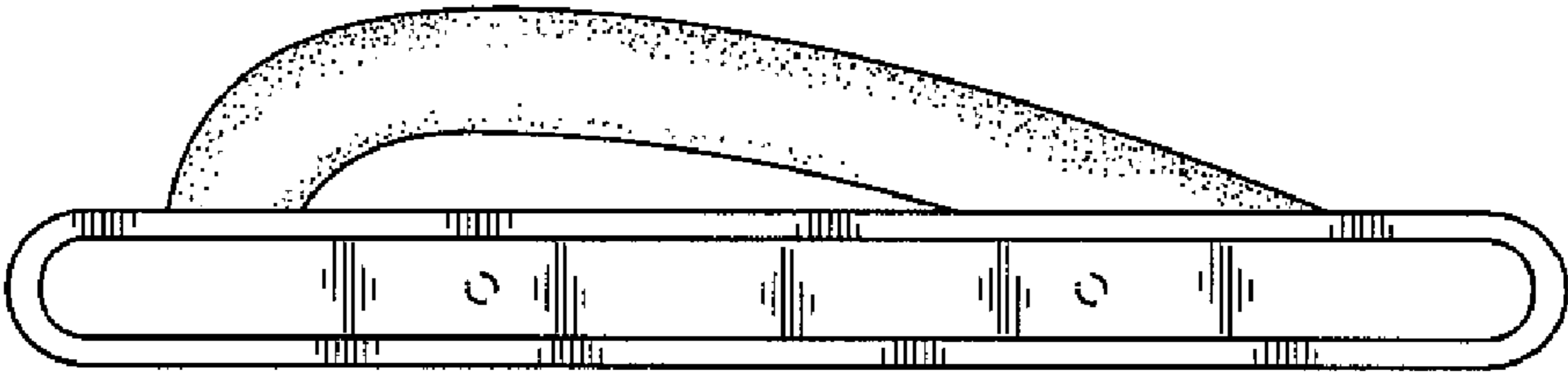
**Fig. 27**



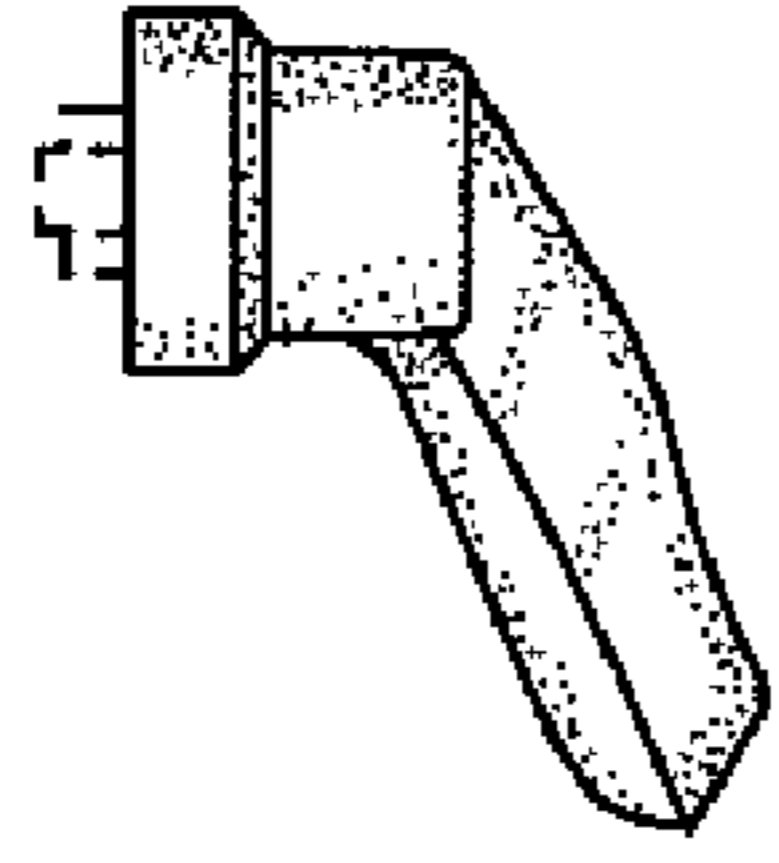
**Fig. 28**



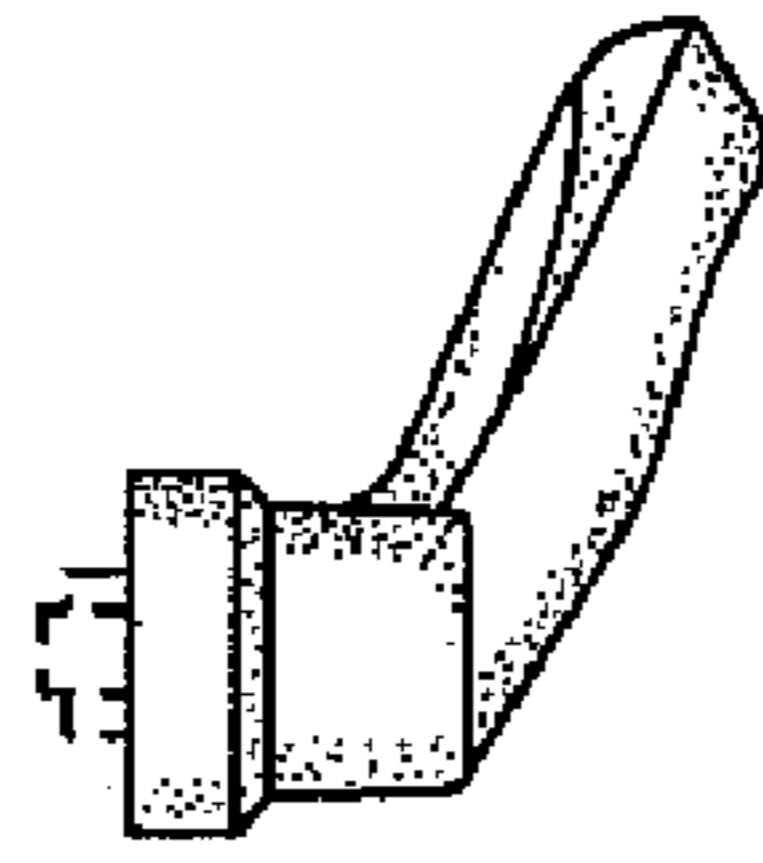
**Fig. 29**



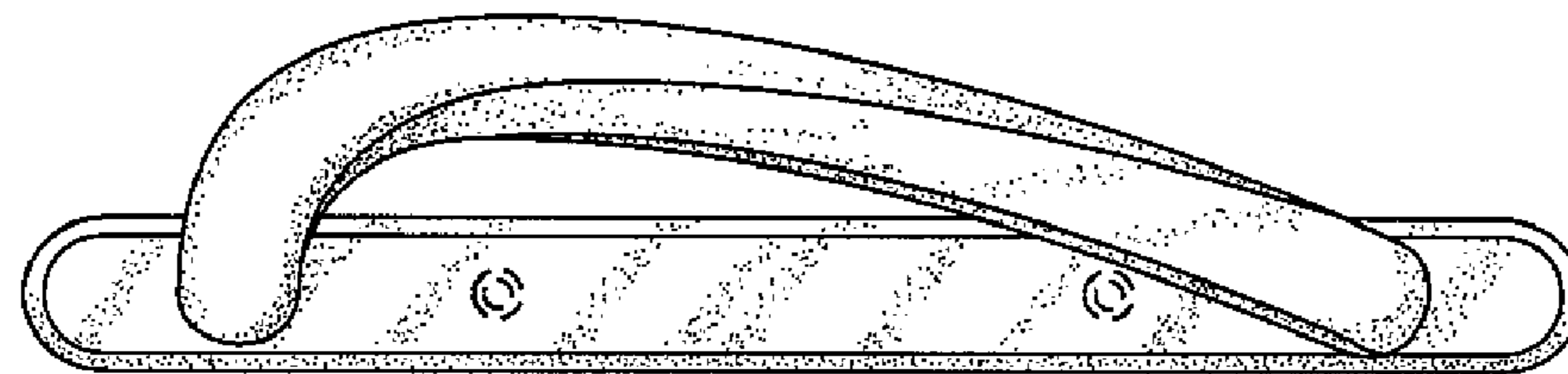
**Fig. 30**



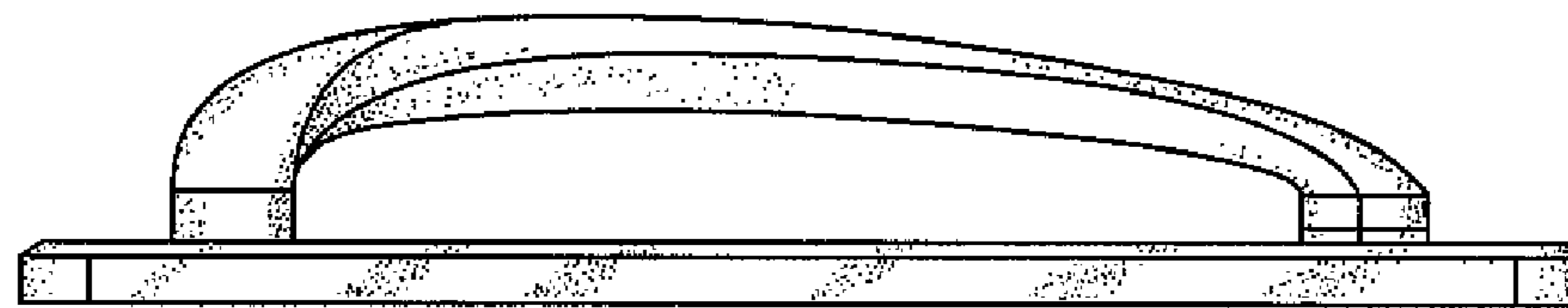
**Fig. 31**



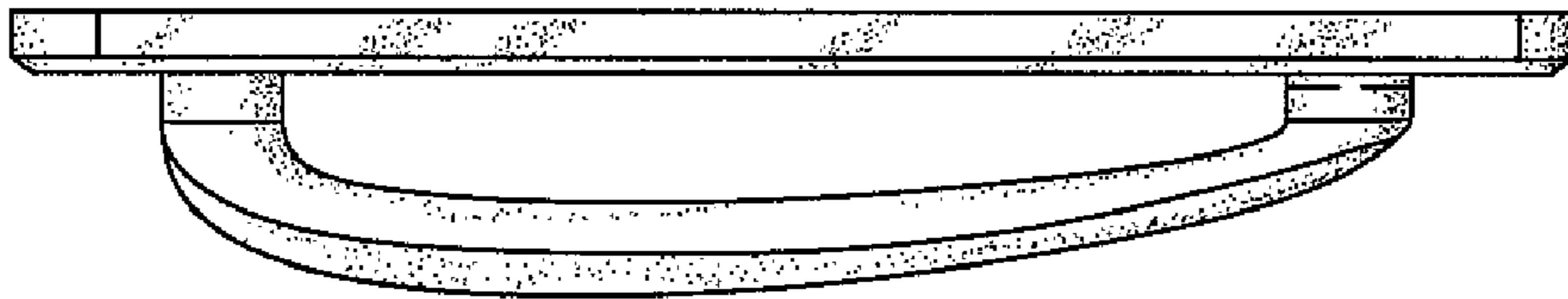
**Fig. 32**



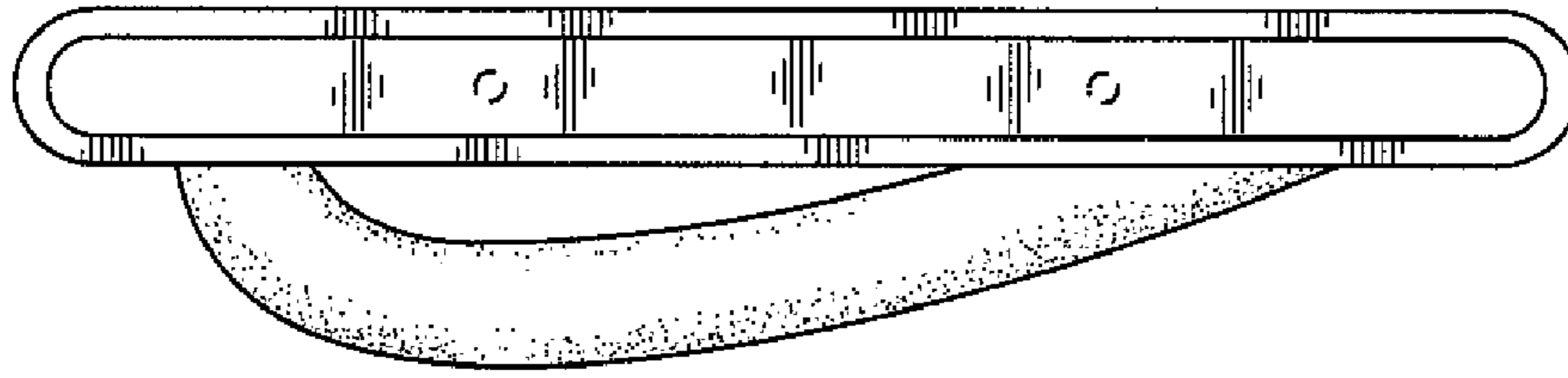
**Fig. 33**



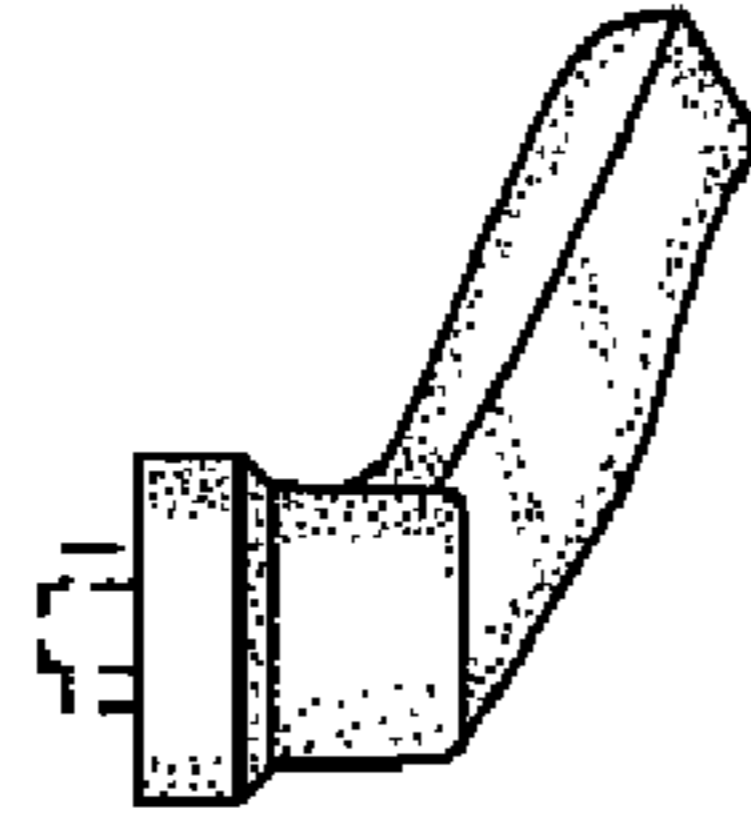
**Fig. 34**



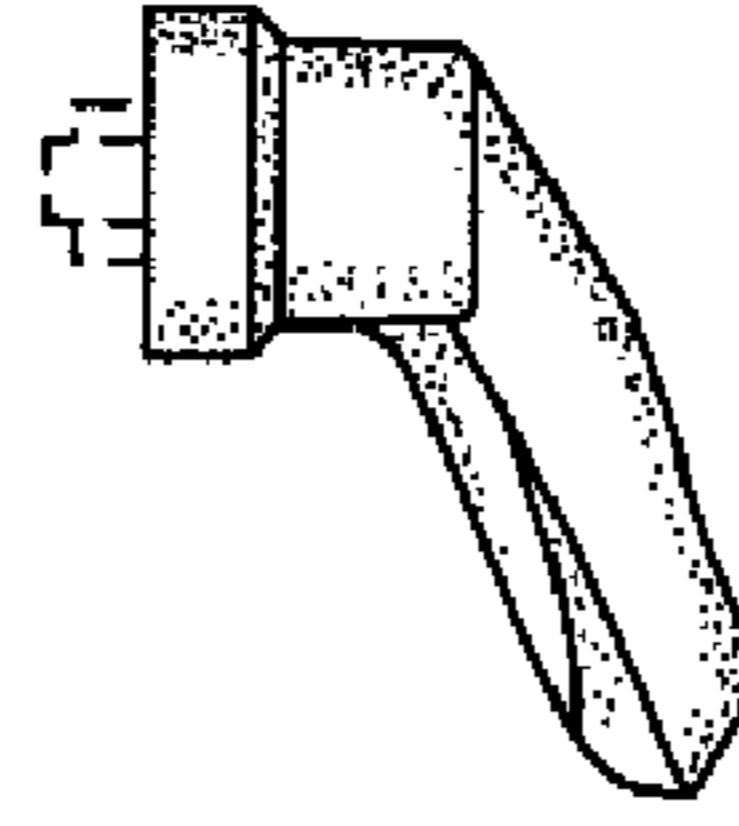
**Fig. 35**



**Fig. 36**

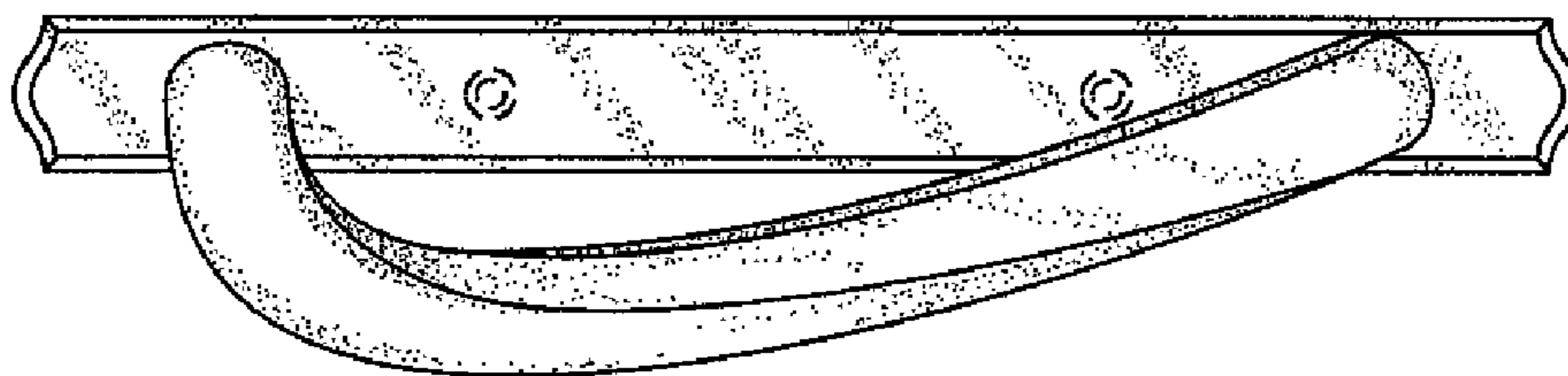


**Fig. 37**

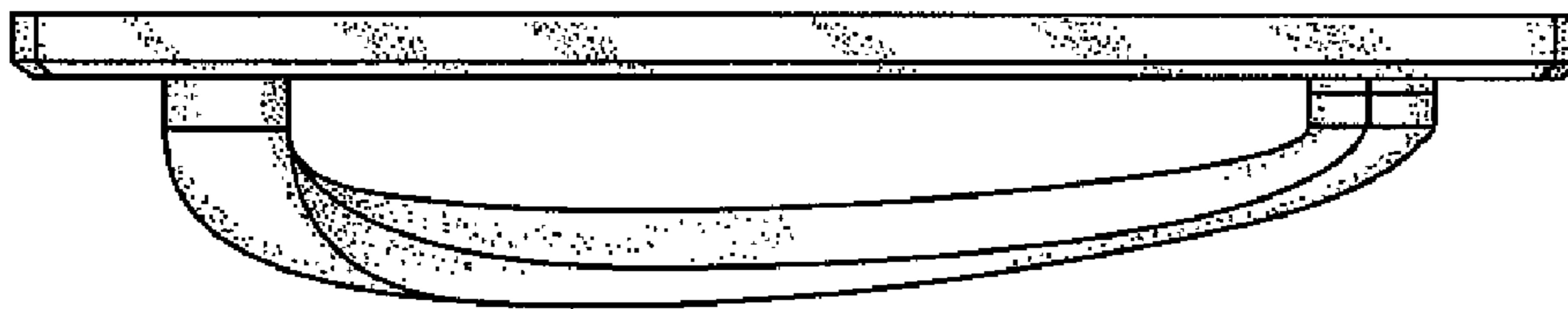


**Fig. 38**

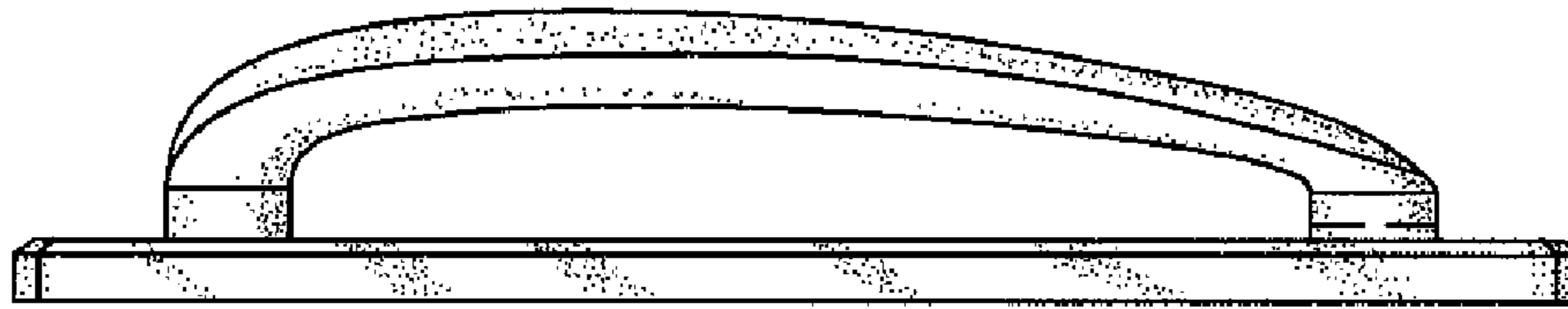




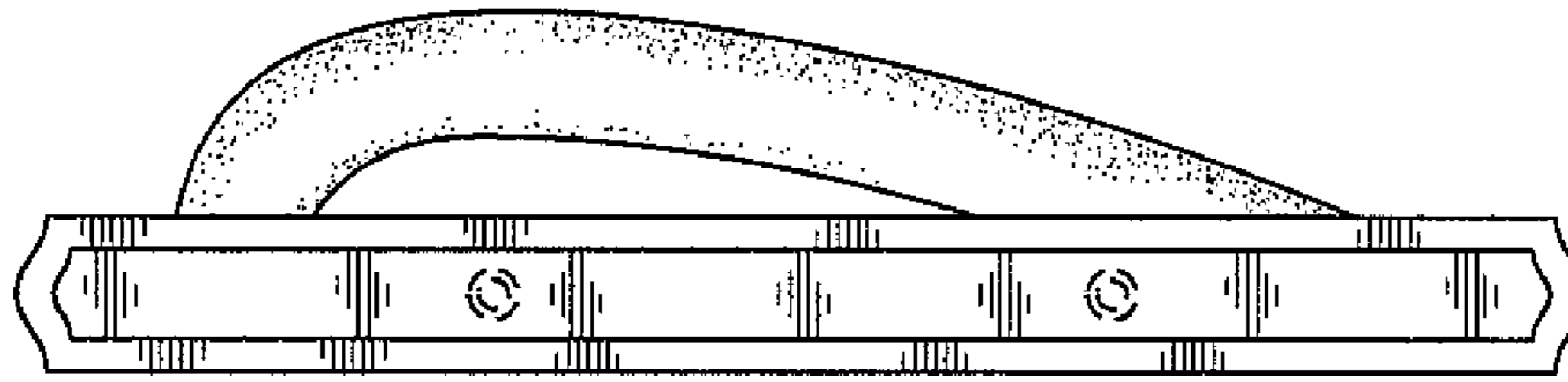
**Fig. 39**



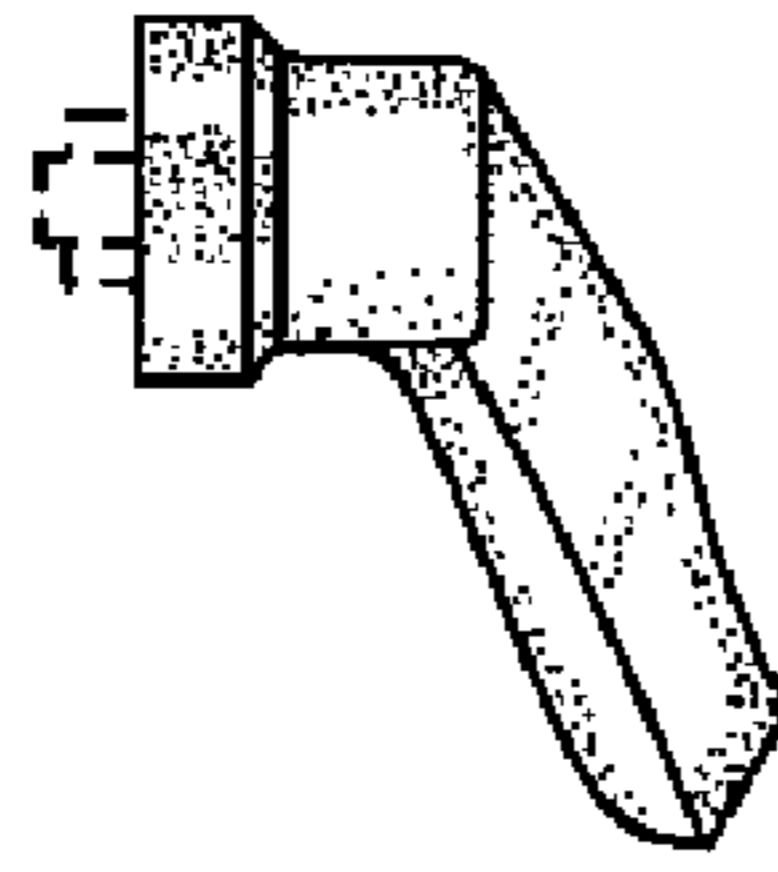
**Fig. 40**



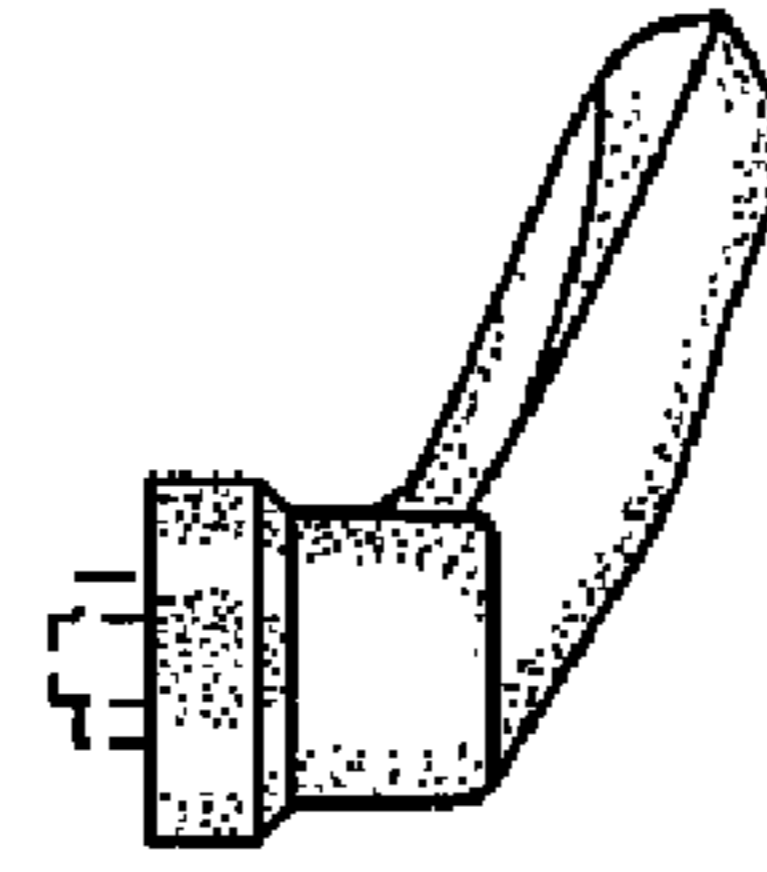
**Fig. 41**



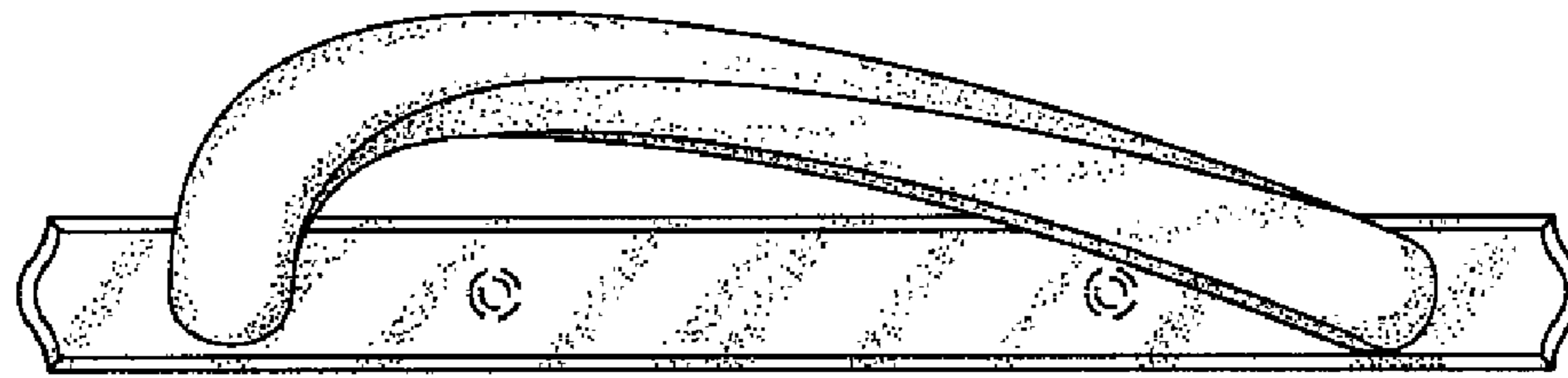
**Fig. 42**



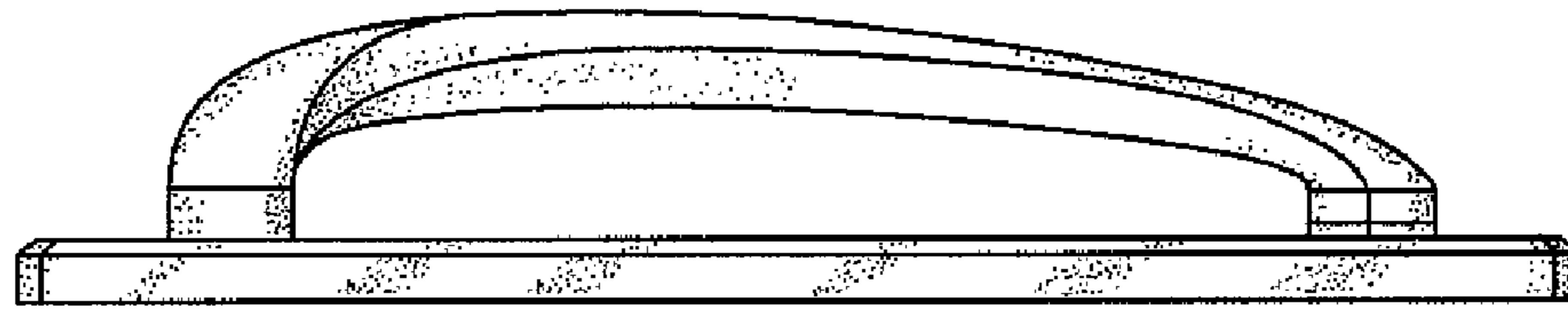
**Fig. 43**



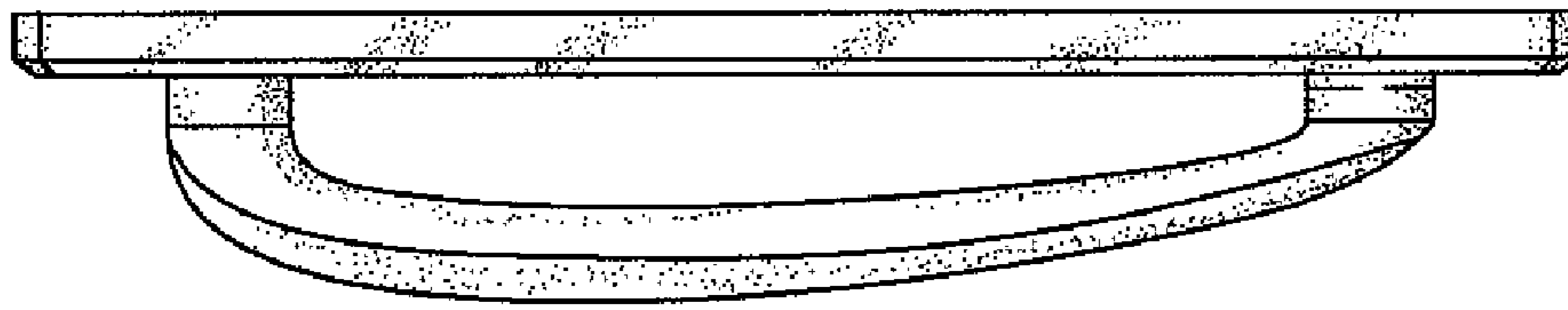
**Fig. 44**



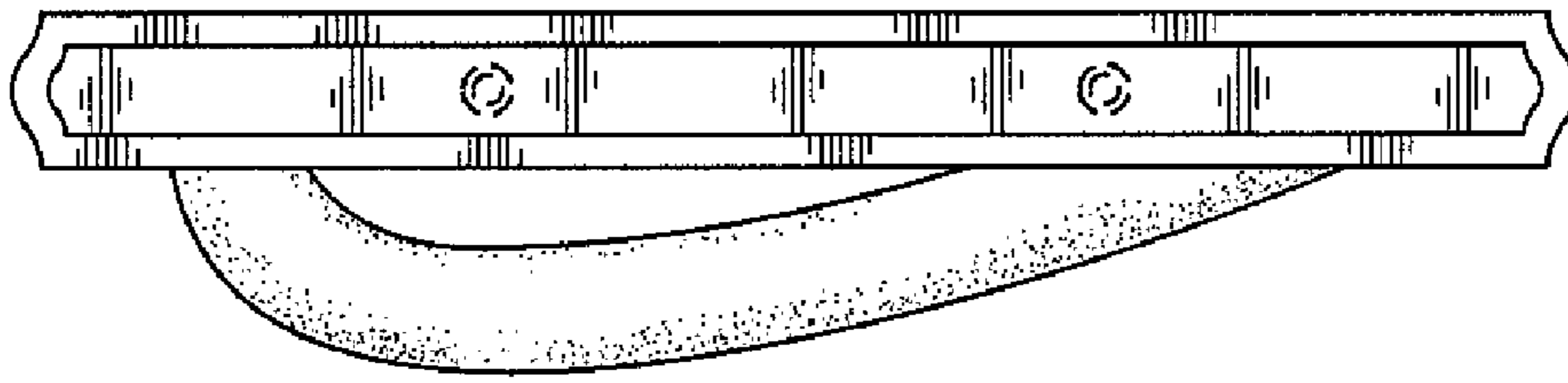
**Fig. 45**



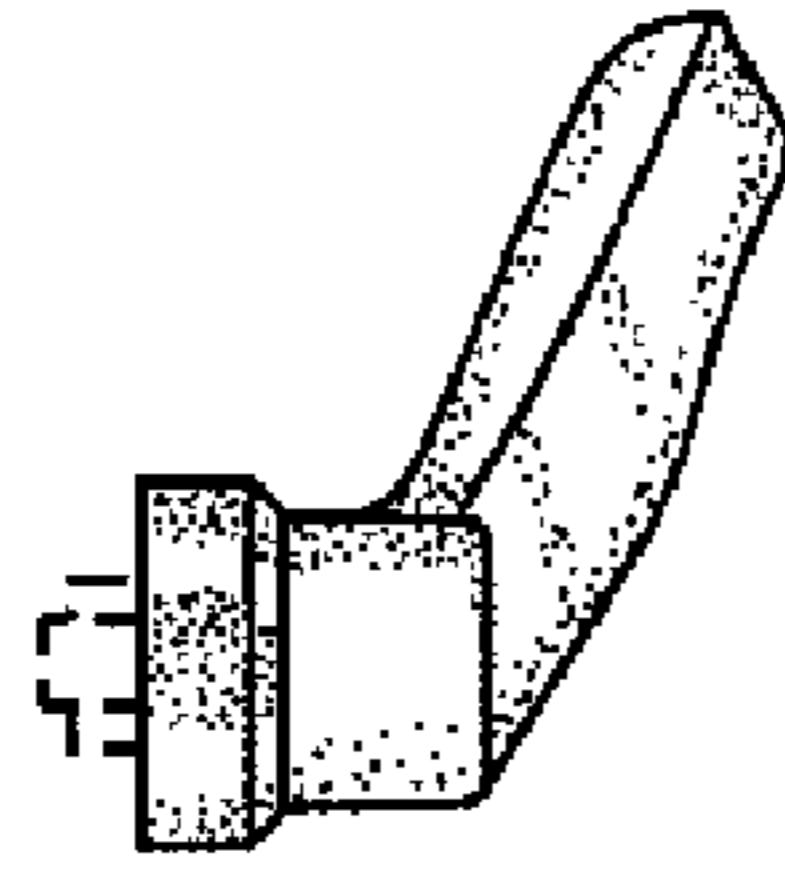
**Fig. 46**



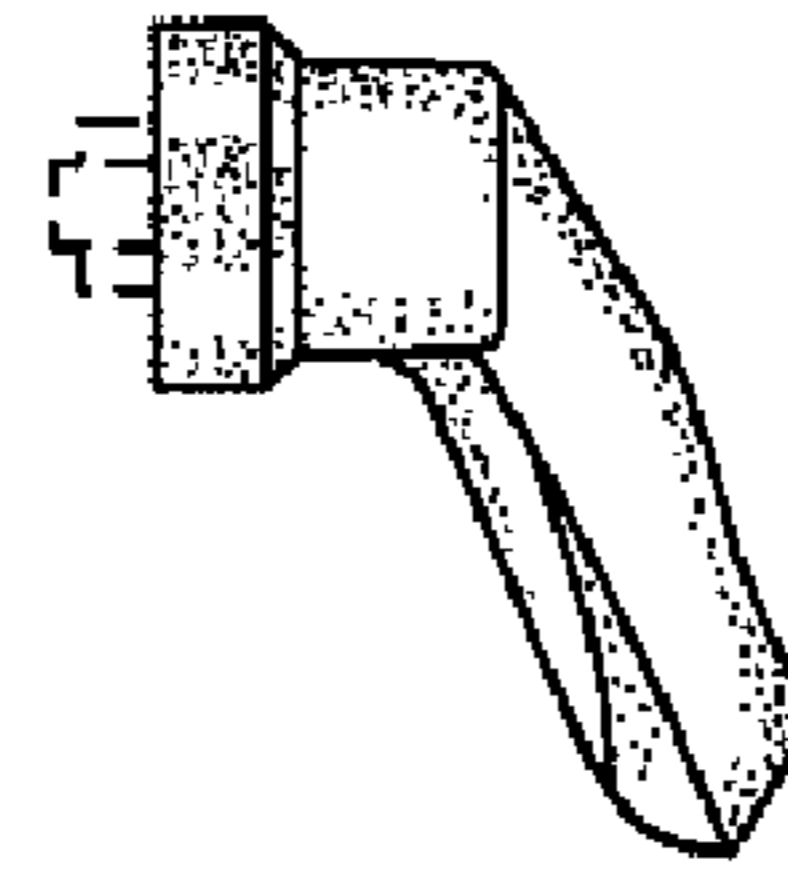
**Fig. 47**



**Fig. 48**



**Fig. 49**



**Fig. 50**