



US00D593334S

(12) **United States Design Patent**
Gillette

(10) **Patent No.:** **US D593,334 S**

(45) **Date of Patent:** **** Jun. 2, 2009**

(54) **INTEGRAL MIRROR AND WEATHER STATION**

(74) *Attorney, Agent, or Firm*—Bryan G. Pratt; Rader, Fishman & Grauer PLLC

(75) **Inventor:** **Jeffrey E. Gillette**, P.O. Box 428, Midway, UT (US) 84049

(57) **CLAIM**

The ornamental design for an integral mirror and weather station, as shown and described.

(73) **Assignee:** **Jeffrey E. Gillette**, Midway, UT (US)

(**) **Term:** **14 Years**

DESCRIPTION

(21) **Appl. No.:** **29/284,034**

FIG. 1 is a perspective view of the integral mirror and weather station.

(22) **Filed:** **Aug. 29, 2007**

FIG. 2 is a front view of the integral mirror and weather station.

(51) **LOC (9) Cl.** **06-07**

FIG. 3 is a rear view of the integral mirror and weather station.

(52) **U.S. Cl.** **D6/309**

FIG. 4 is a left side elevation view of the integral mirror and weather station.

(58) **Field of Classification Search** D6/300–314; D10/53, 2; D14/191, 171; D16/208; 73/170.16
See application file for complete search history.

FIG. 5 is a right side elevation view of the integral mirror and weather station.

(56) **References Cited**

U.S. PATENT DOCUMENTS

D287,942 S *	1/1987	Tanaka	D10/53
D345,736 S *	4/1994	Scheid	D14/191
D352,664 S *	11/1994	Peersmann	D10/2
D486,961 S *	2/2004	Prince et al.	D6/302
D560,702 S *	1/2008	Tokiwa et al.	D16/208
D561,805 S *	2/2008	Tokiwa et al.	D16/208
2007/0251312 A1 *	11/2007	Gillette	73/170.16

FIG. 6 is a top view of the integral mirror and weather station; and,

FIG. 7 is a bottom view of the integral mirror and weather station.

The surface shading illustrated in the drawings is provided merely to highlight the contour of design; it is not intended to be illustrative of texture or gloss and forms no part of the claimed design.

* cited by examiner

The portions of the integral mirror and weather station shown in broken lines form no part of the claimed design.

Primary Examiner—Caron Veynar
Assistant Examiner—Sydney R Buffalow

1 Claim, 4 Drawing Sheets

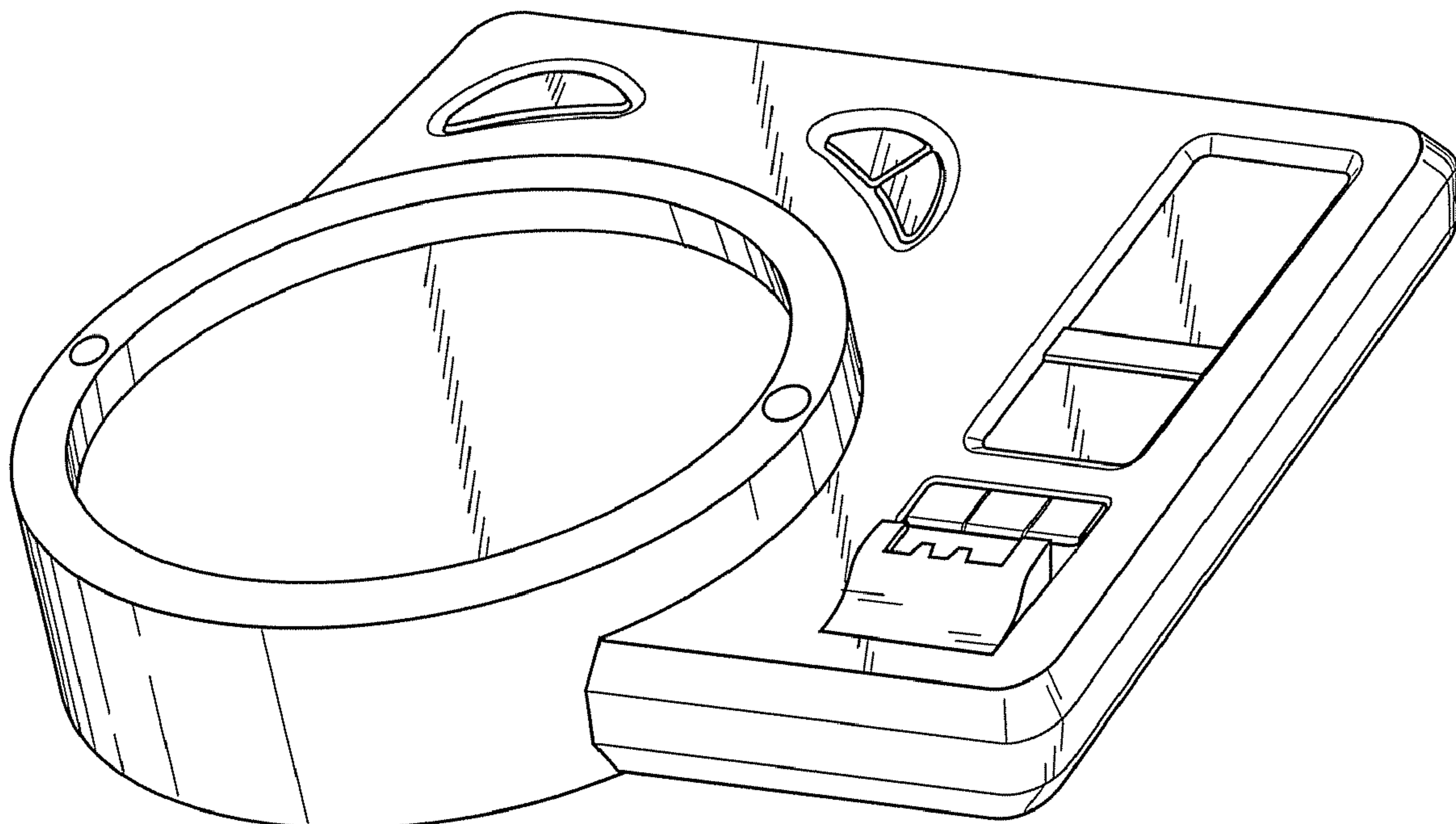

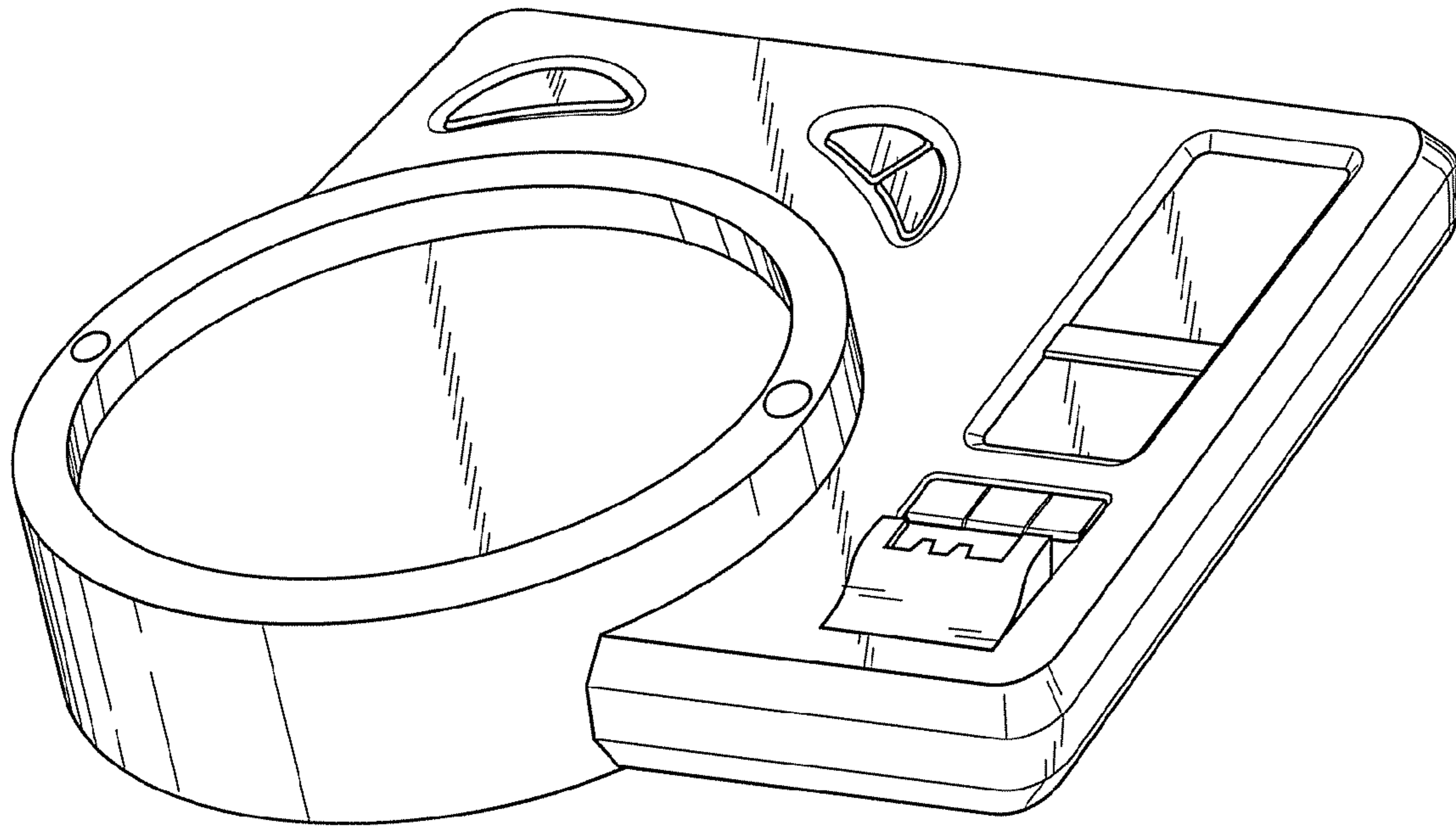

Fig. 1

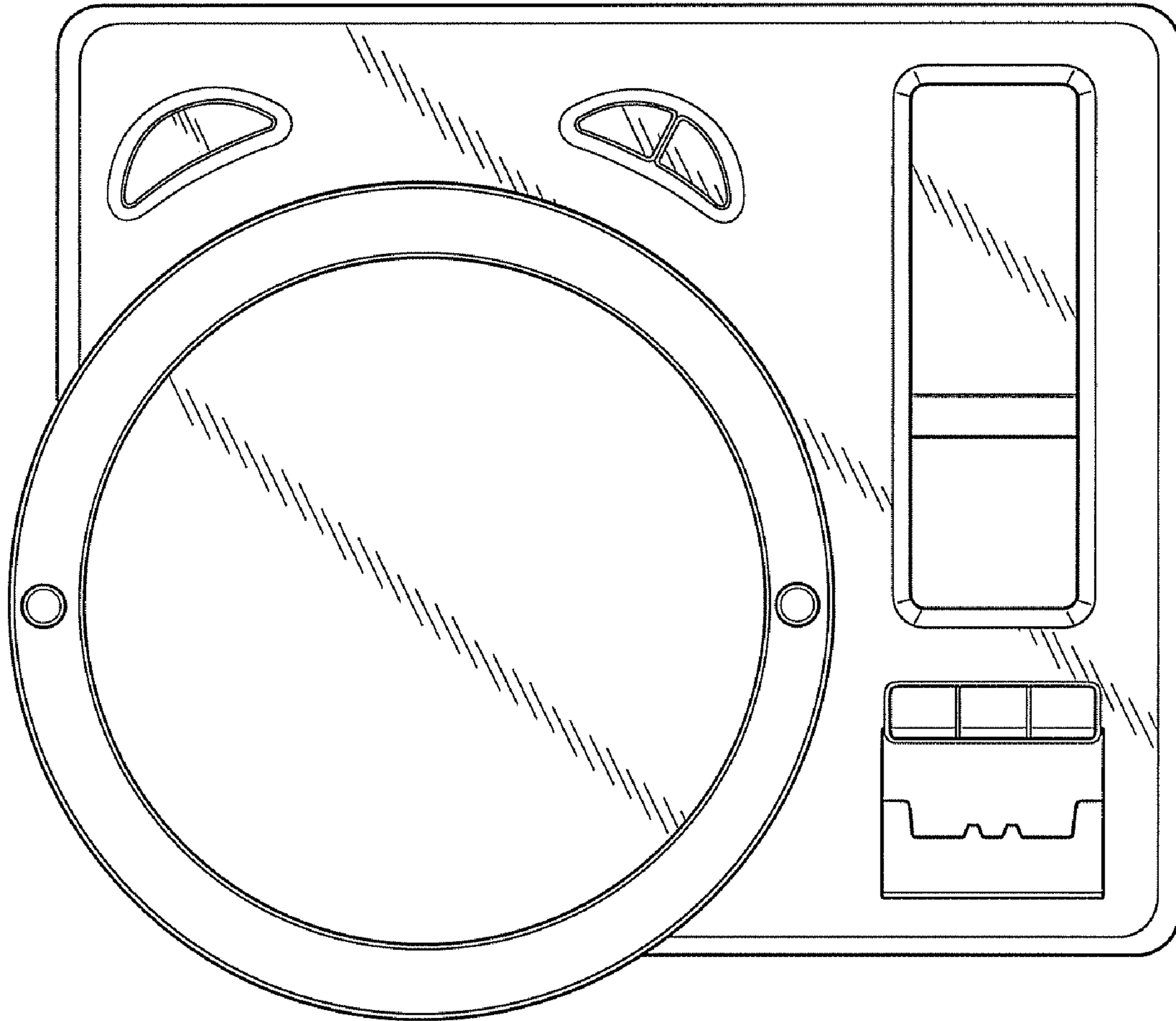

Fig. 2

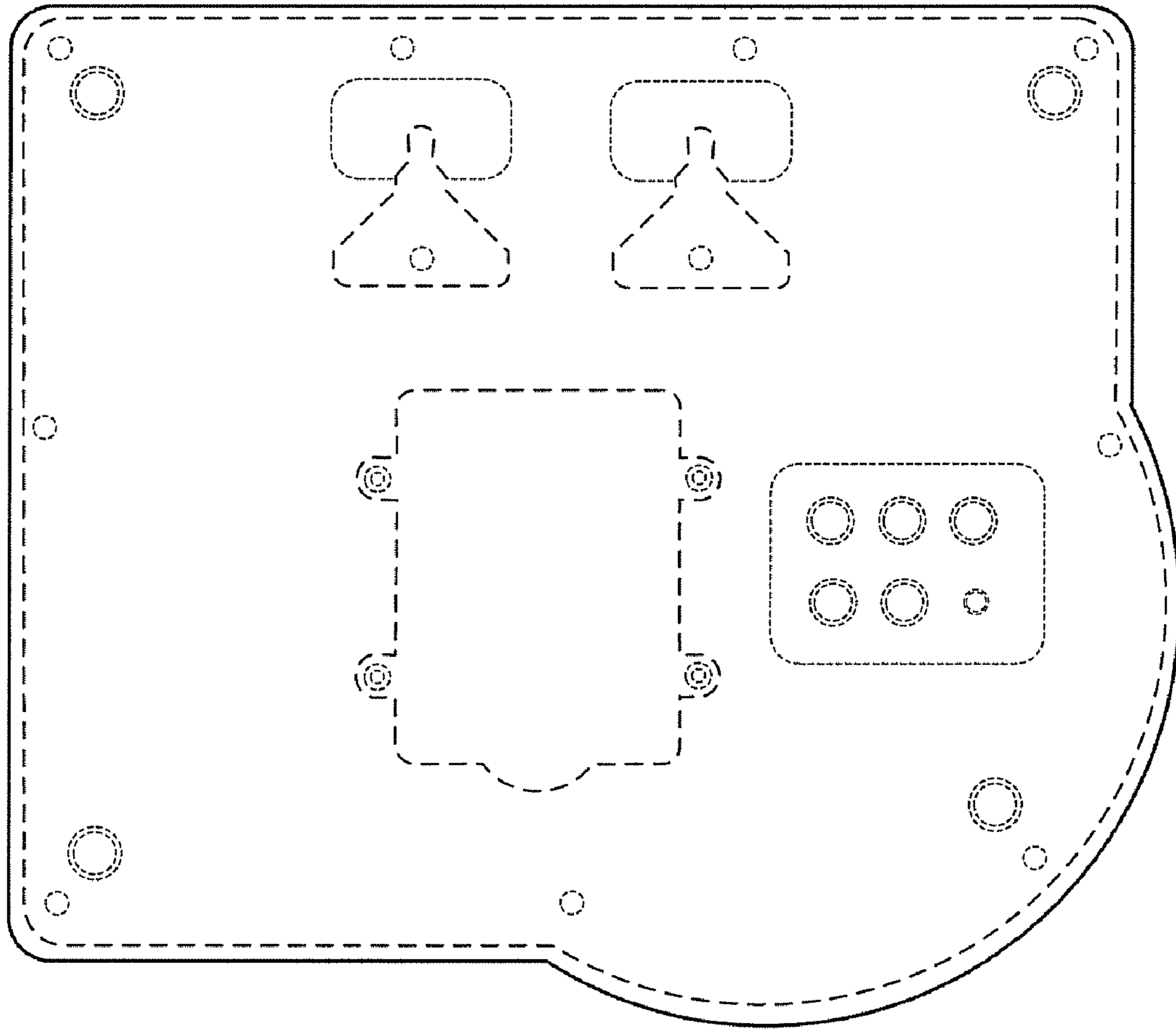

Fig. 3

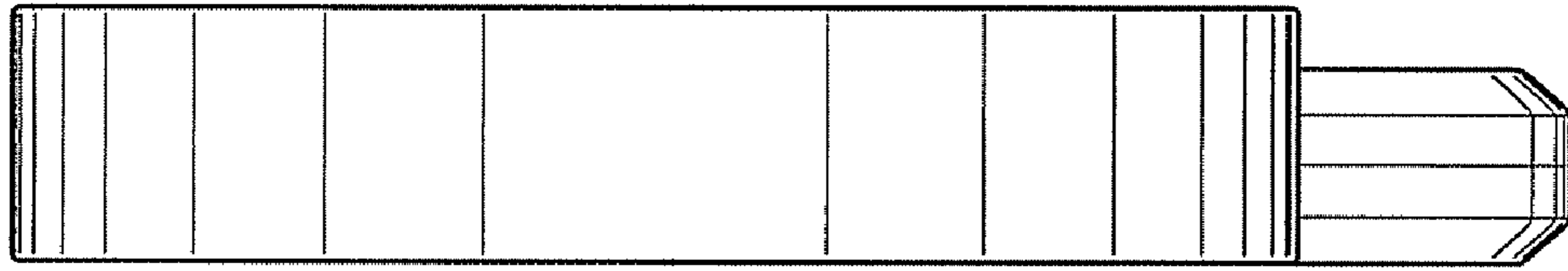

Fig. 4

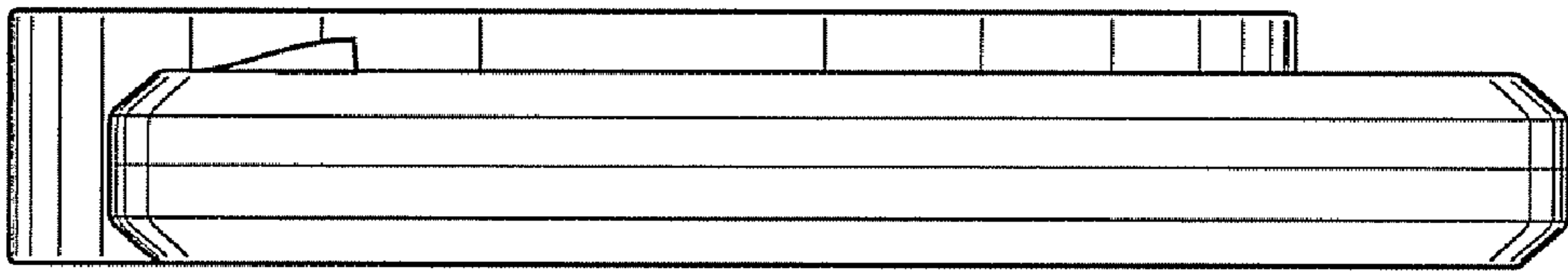

Fig. 5

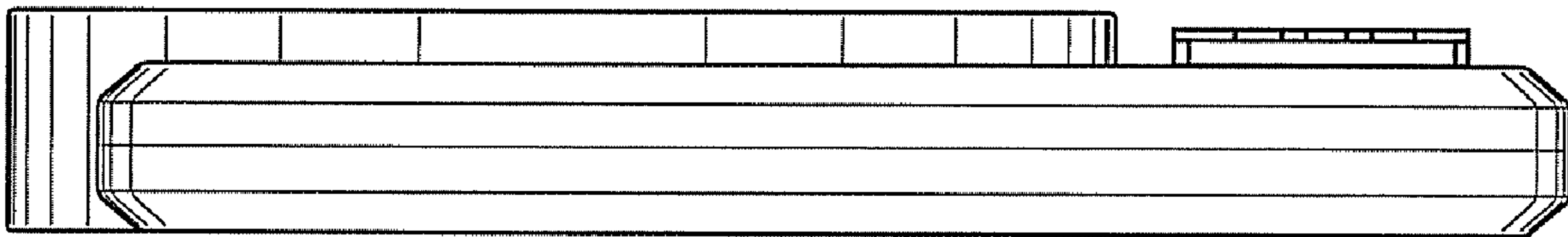

Fig. 6

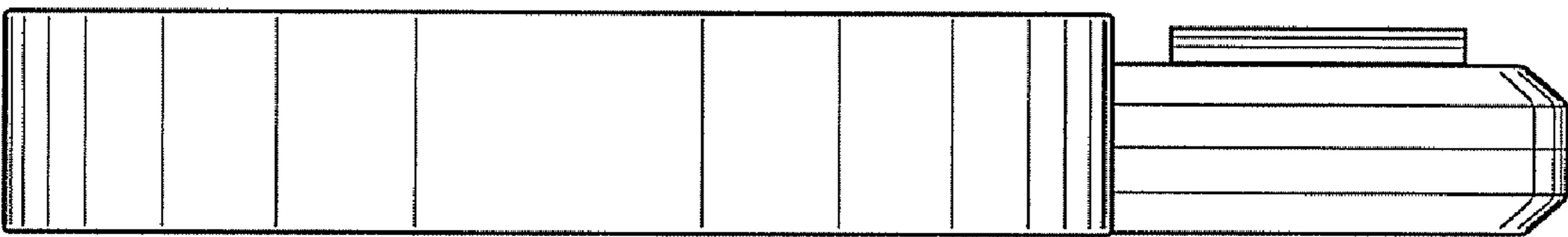

Fig. 7