

US00D593330S

(12) **United States Design Patent**
Berhault

(10) **Patent No.:** **US D593,330 S**
(45) **Date of Patent:** **** Jun. 2, 2009**

(54) **MASCARA BRUSH**

7,254,860 B2 8/2007 Dumler et al.

(75) Inventor: **Alain Berhault**, Paris (FR)

(Continued)

(73) Assignee: **Alcan Packaging Beauty Services** (FR)

FOREIGN PATENT DOCUMENTS

(**) Term: **14 Years**

EP 1384417 1/2004

(21) Appl. No.: **29/323,055**

(Continued)

(22) Filed: **Aug. 15, 2008**

OTHER PUBLICATIONS

Related U.S. Application Data

EM 540869-0002 Industrial Design Application, (Geka Brush GmbH) Jul. 18, 2006, [online], [retrieved on Sep. 28, 2008], Retrieved from the OAMI Database of the Office for Harmonization in the Internal Market using the Internet <URL: <http://oami.europa.eu>>.

(62) Division of application No. 29/279,786, filed on May 8, 2007, now Pat. No. Des. 588,818.

(Continued)

(30) **Foreign Application Priority Data**

Primary Examiner—Melanie H Tung
Assistant Examiner—Lavone D Tabor
(74) *Attorney, Agent, or Firm*—Banner & Witcoff, Ltd.

Nov. 9, 2006 (EM) 000 623 202

(51) **LOC (9) Cl.** **04-02**

(52) **U.S. Cl.** **D4/128; D4/136**

(58) **Field of Classification Search** D4/128,
D4/133, 136; D28/7, 35-37; 15/27, 186-188,
15/207.2, DIG. 5; 132/216-218, 223, 226,
132/237, 262, 271, 317, 320; 401/28, 126,
401/127, 129

(57) **CLAIM**

See application file for complete search history.

The ornamental design for a mascara brush, as shown and described.

DESCRIPTION

(56) **References Cited**

FIG. 1 is a front right perspective view of a mascara brush showing my new design;
FIG. 2 is a right elevation view thereof;
FIG. 3 is a top plan view thereof;
FIG. 4 is a left elevation view thereof;
FIG. 5 is a bottom plan view thereof;
FIG. 6 is a front end view thereof, enlarged to depict my claimed design more clearly; and,
FIG. 7 is a rear end view thereof, enlarged to depict my claimed design more clearly.

U.S. PATENT DOCUMENTS

D247,076 S	1/1978	MacCollum	
4,527,575 A	7/1985	Vasas	
4,635,659 A *	1/1987	Spatz	132/218
4,964,429 A	10/1990	Cole	
5,345,644 A	9/1994	Gueret	
5,709,230 A	1/1998	Miraglia	
5,794,632 A	8/1998	Gueret	
5,860,432 A	1/1999	Gueret	
5,862,812 A	1/1999	Dumler	
5,934,292 A	8/1999	Gueret	
D441,199 S	5/2001	Johnstone et al.	
6,616,366 B1	9/2003	Weihrauch	
7,121,284 B2	10/2006	Gueret	
7,171,969 B2	2/2007	Gueret	

The dash-dot-dash lines immediately adjacent to the shaded areas of the mascara brush represent unclaimed boundaries of the claimed design. The dot-dot lines showing the remainder of the mascara brush are for illustrative purposes only and form no part of the claimed design.

1 Claim, 4 Drawing Sheets

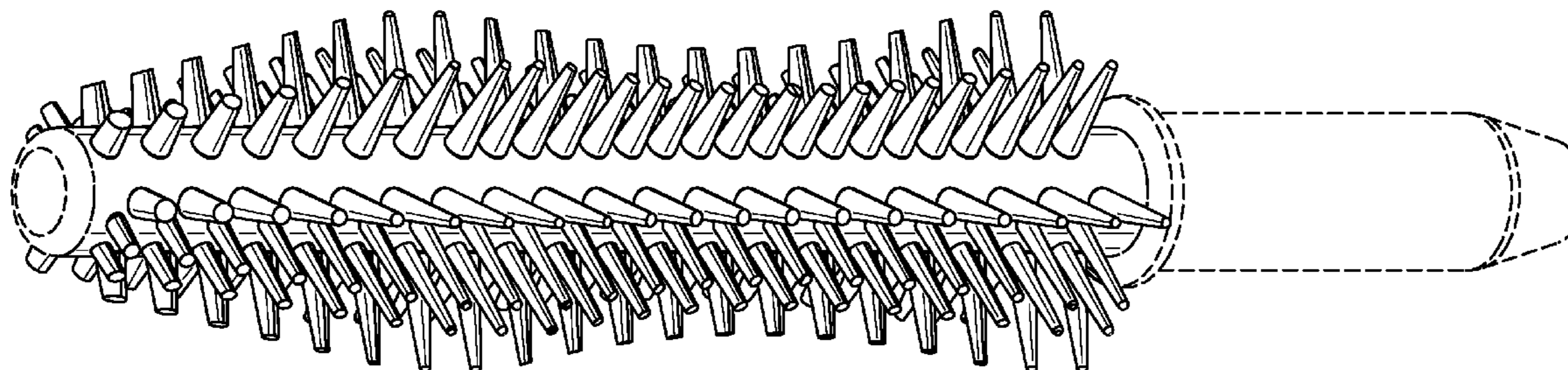

US D593,330 S

Page 2

U.S. PATENT DOCUMENTS

7,325,550 B2 2/2008 Eckers et al.
D564,233 S 3/2008 Dumler et al.
D564,234 S 3/2008 Dumler et al.
D570,117 S * 6/2008 Dumler et al. D4/128
2003/0172485 A1 9/2003 Dumler et al.
2005/0034740 A1 2/2005 Eckers et al.
2005/0217691 A1 10/2005 Petit
2005/0249539 A1 11/2005 Habatjou
2006/0002758 A1 1/2006 Gueret
2006/0260633 A1 11/2006 Wyatt et al.
2006/0289027 A1 * 12/2006 Wyatt et al. 132/218
2007/0033759 A1 * 2/2007 Dumler 15/187
2007/0033760 A1 * 2/2007 Dumler 15/187
2007/0034223 A1 2/2007 Dumler et al.
2007/0062551 A1 * 3/2007 De Brouwer et al. 132/218
2007/0062552 A1 3/2007 De Brouwer et al.
2007/0204875 A1 9/2007 Kim
2007/0221241 A1 9/2007 Gueret
2008/0011317 A1 * 1/2008 Malvar et al. 132/218

2008/0023020 A1* 1/2008 Gueret 132/218

FOREIGN PATENT DOCUMENTS

EP 1752067 2/2007

OTHER PUBLICATIONS

EM 386388-0025 Industrial Design Application, (Geka Brush GmbH) Aug. 12, 2005, [online], [retrieved on Sep. 30, 2008], Retrieved from the OAMI Database of the Office for Harmonization in the Internal Market using the Internet <URL: <http://oami.europa.eu>>.

EM 386388-0023 Industrial Design Application, (Geka Brush GmbH) Nov. 1, 2005, [online], [retrieved on Sep. 18, 2008], Retrieved from the OAMI Database of the Office for Harmonization in the Internal Market using the Internet <URL: <http://oami.europa.eu>>.

EM 330436-0005 Industrial Design Application, (Geka Brush GmbH) Jun. 14, 2005, [online], [retrieved on Sep. 18, 2008], Retrieved from the OAMI Database of the Office for Harmonization in the Internal Market using the Internet <URL: <http://oami.europa.eu>>.

* cited by examiner

Fig. 1

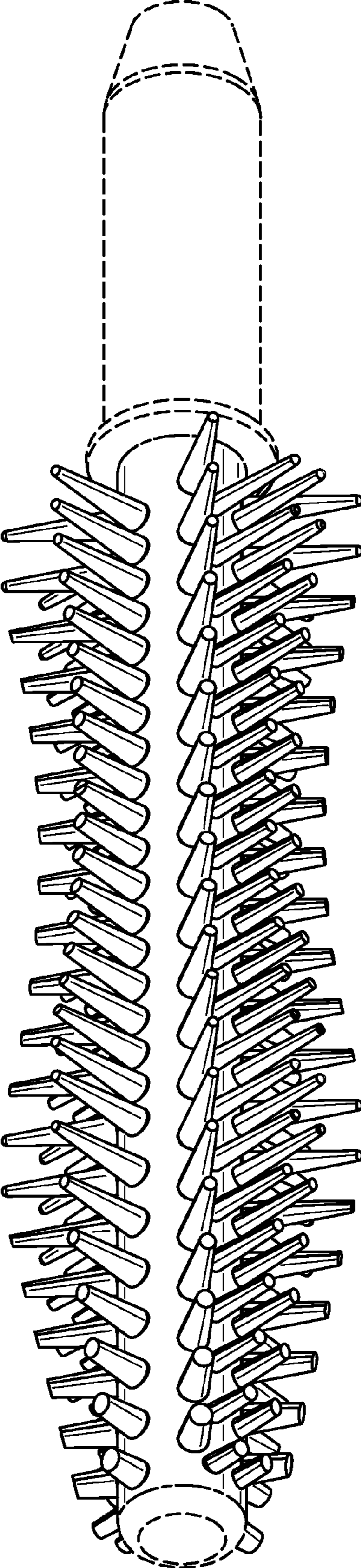

Fig. 2

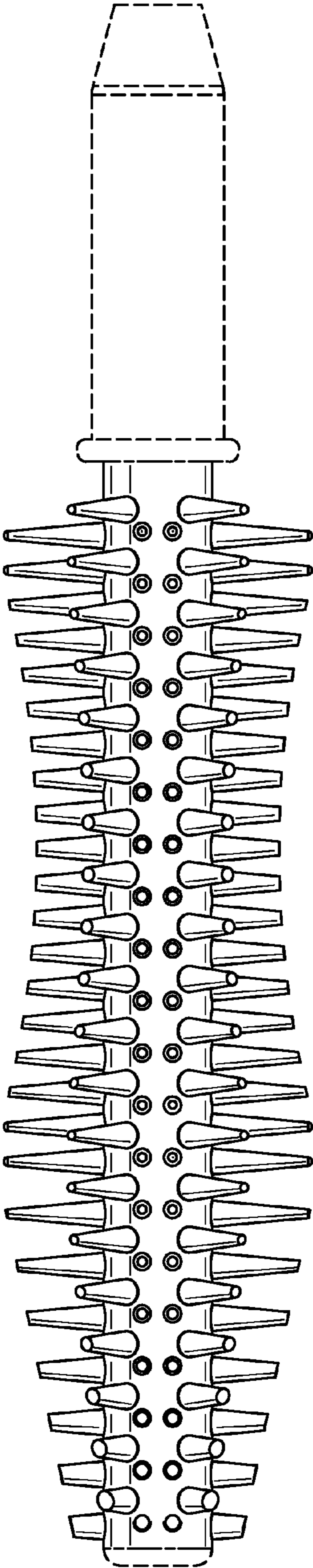

Fig. 3

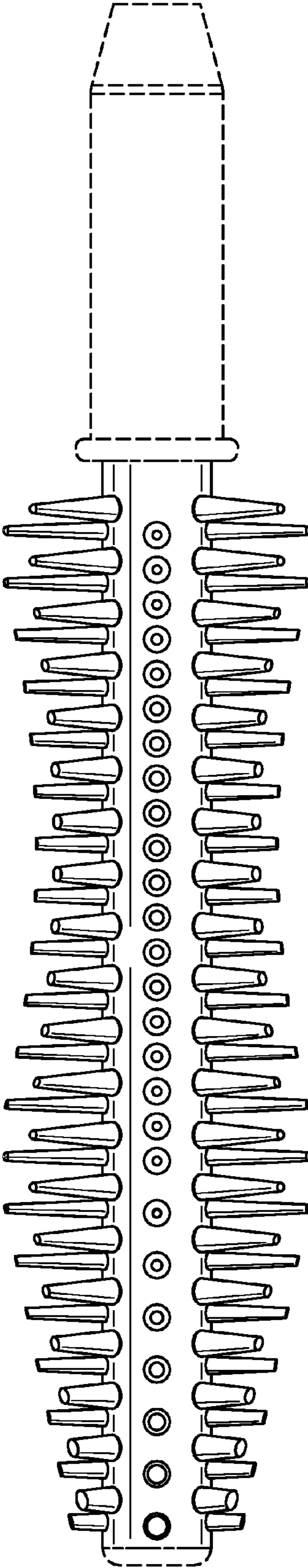

Fig. 4

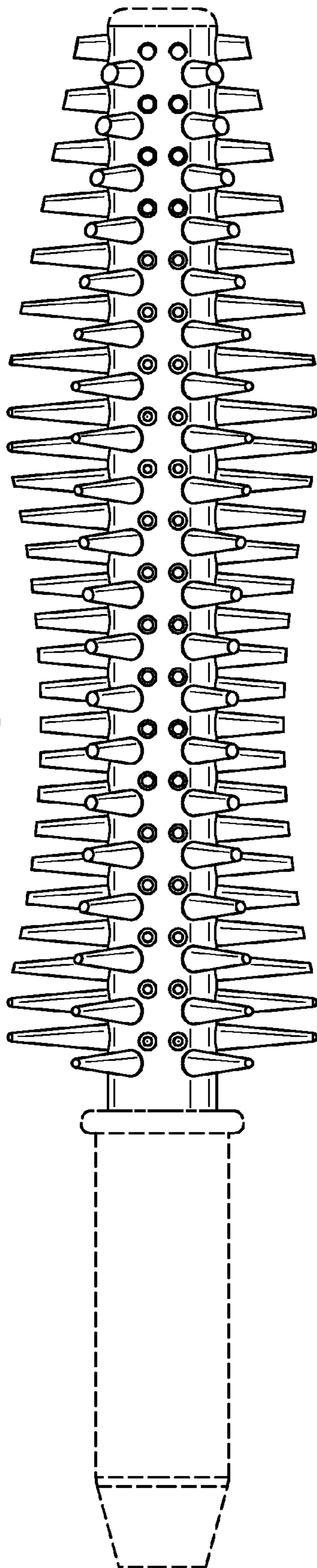

Fig. 5

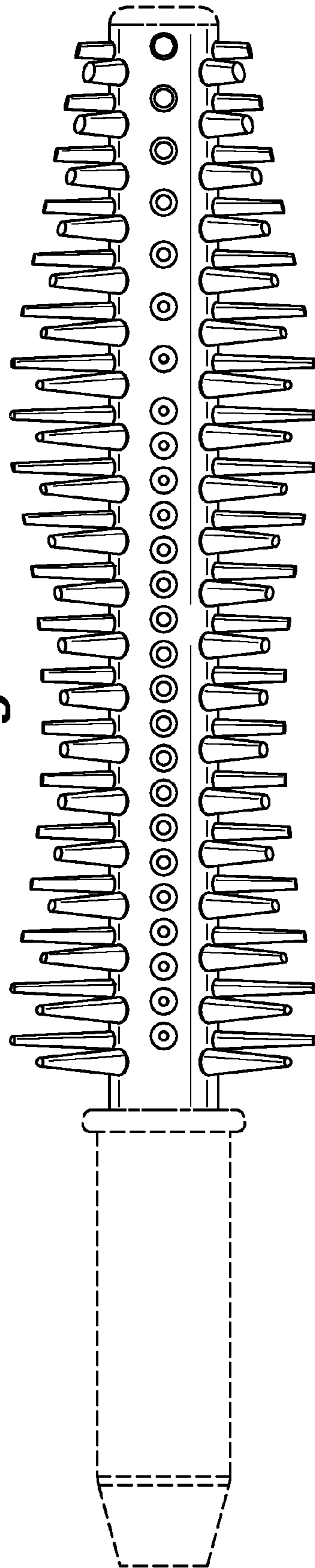

Fig. 6

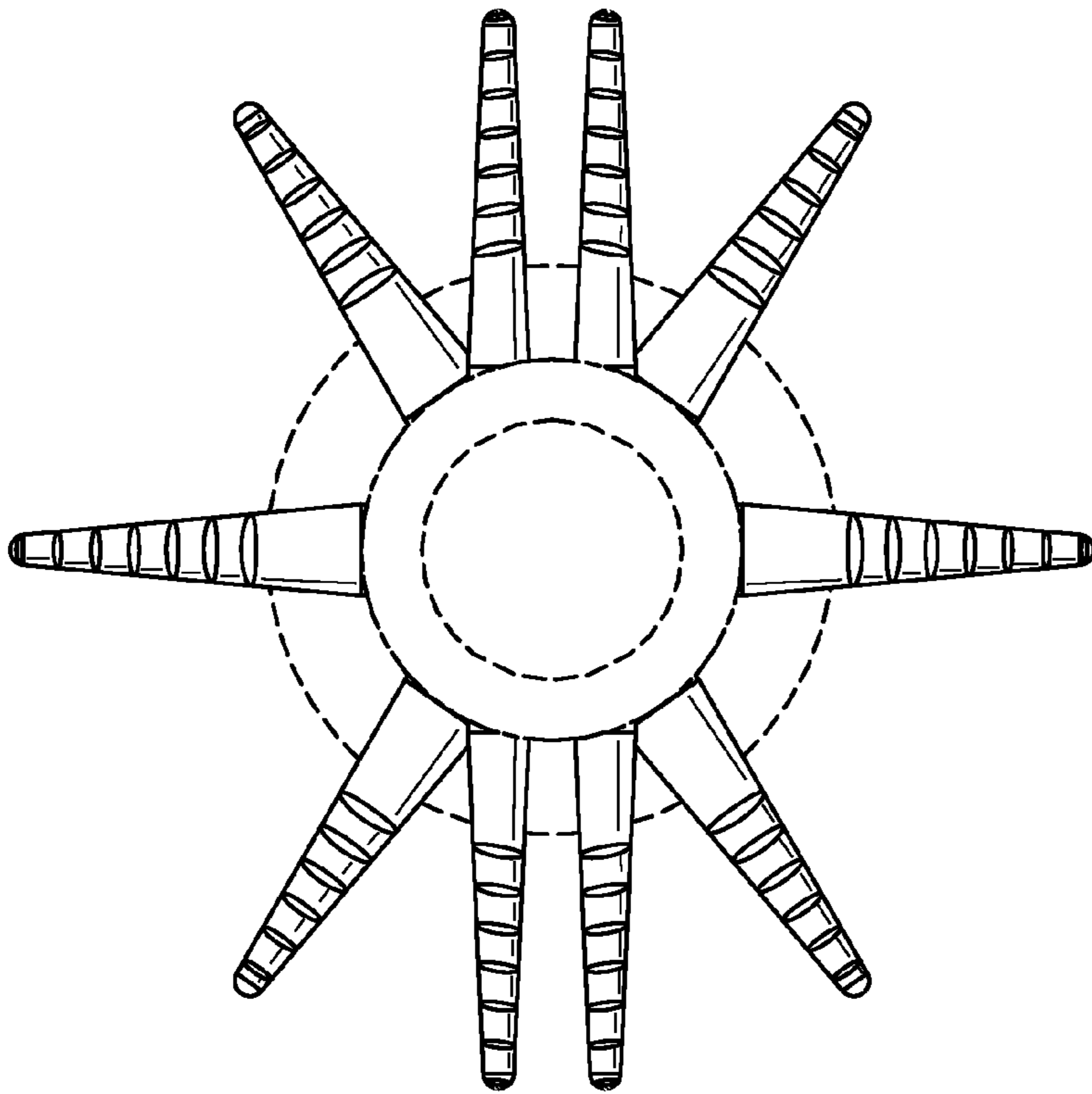

Fig. 7

