



US00D593146S

(12) **United States Design Patent**
Powless

(10) **Patent No.:** **US D593,146 S**

(45) **Date of Patent:** **** May 26, 2009**

(54) **PROTECTIVE TEMPLE SLEEVE FOR EYEGLASSES**

(74) *Attorney, Agent, or Firm*—Harness, Dickey & Pierce, P.L.C.

(76) **Inventor:** **Theresa N Powless**, 875 Brandon Ave., Pontiac, MI (US) 48340

(57) **CLAIM**

(**) **Term:** **14 Years**

The ornamental design for a protective temple sleeve for eyeglasses, as shown and described.

(21) **Appl. No.:** **29/305,000**

DESCRIPTION

(22) **Filed:** **Mar. 11, 2008**

FIG. 1 is a left-side view of a protective temple sleeve placed onto a curved right temple of a pair of eyeglasses;

(51) **LOC (9) Cl.** **16-06**

FIG. 2 is a right-side view of the protective temple sleeve;

(52) **U.S. Cl.** **D16/336**

FIG. 3 is a cutaway front view of the protective sleeve viewed from between the lenses of the glasses and the protective temple sleeve;

(58) **Field of Classification Search** D16/101, D16/300–342; D27/148; D21/190; D24/110.2; 351/43, 122, 158; 2/12, 13, 437, 15; 206/5; D12/196; D14/156, 206, 223
See application file for complete search history.

FIG. 4 is a front view of the protective temple sleeve;

FIG. 5 is a rear view of the protective temple sleeve;

(56) **References Cited**

U.S. PATENT DOCUMENTS

FIG. 6 is a top view of the protective temple sleeve; and,

FIG. 7 is an alternate left-side view showing the protective temple sleeve placed onto a straight right temple of a pair of eyeglasses.

D58,109	S	*	6/1921	Richert	D21/440
D159,718	S	*	8/1950	Daniel	446/220
3,993,403	A	*	11/1976	Brown	351/158
4,786,158	A	*	11/1988	Barfus-Shanks et al.	351/111
D322,446	S	*	12/1991	Bell, Jr.	D16/335
5,440,355	A	*	8/1995	Ross	351/122
D388,115	S	*	12/1997	Celaschi et al.	D16/339
D389,853	S	*	1/1998	Kosakowski	D16/336
D430,229	S	*	8/2000	Sengsouvanh et al.	D21/405
6,270,217	B1	*	8/2001	Lizzi	351/122
D487,119	S	*	2/2004	Komar	D21/439

The broken line showing of the temple and lens is for illustrative purposes only and forms no part of the claimed design.

A disposable, narrow, condom-like, latex “sleeve,” approximately 4" to 5" in length, made for rolling onto the temples of eyeglasses when a person is having his/her hair treated with colorants, relaxers or other chemicals, so as to protect the temples from exposure to harsh chemicals, and thereby allowing the person to wear his/her eyeglasses while the chemicals process.

* cited by examiner

The temple sleeve can be bent as depicted in FIGS. 1–6, or it can be straight as depicted in FIG. 7.

Primary Examiner—Raphael Barkai
Assistant Examiner—Barbara B Lohr

1 Claim, 1 Drawing Sheet

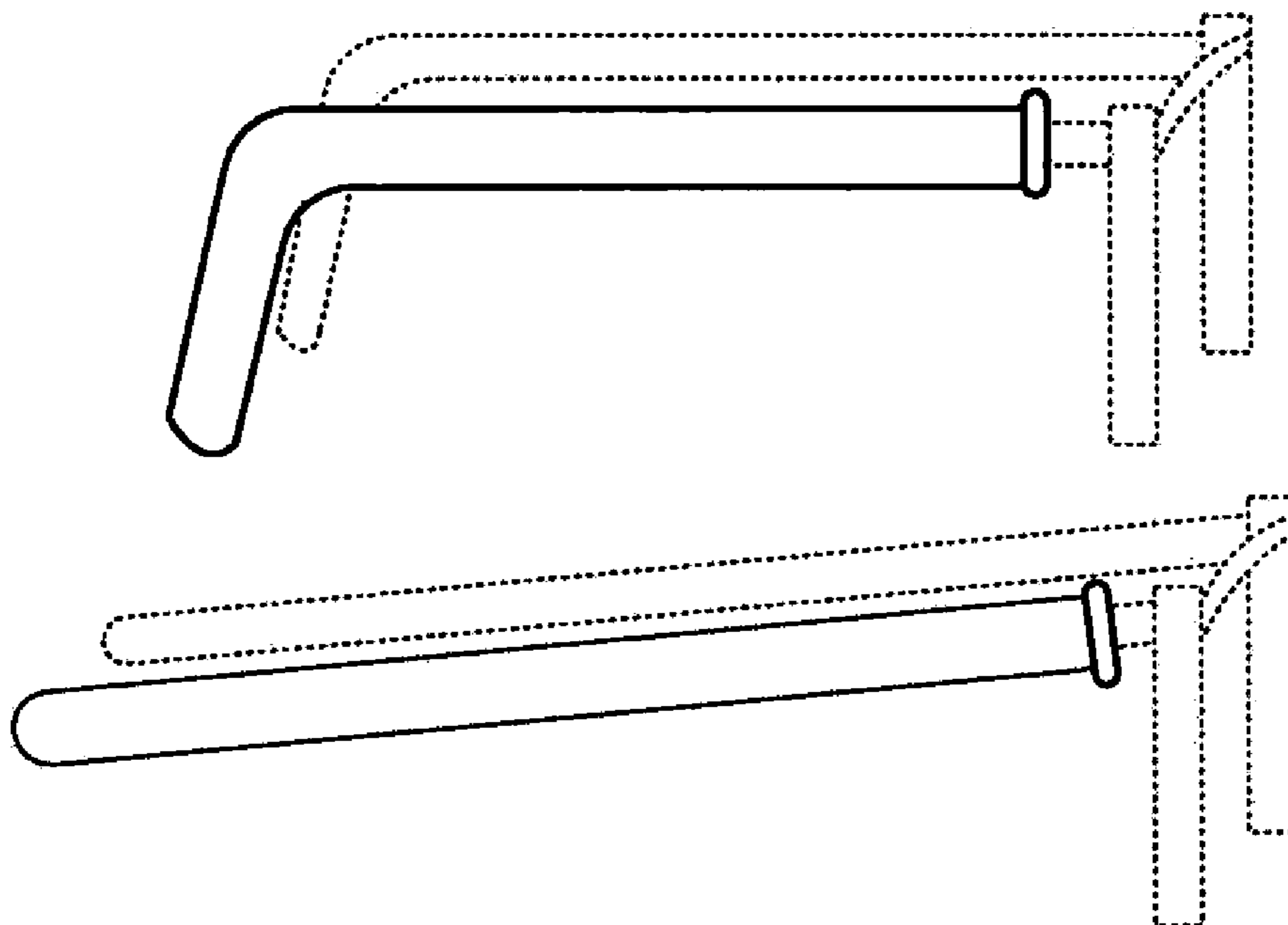

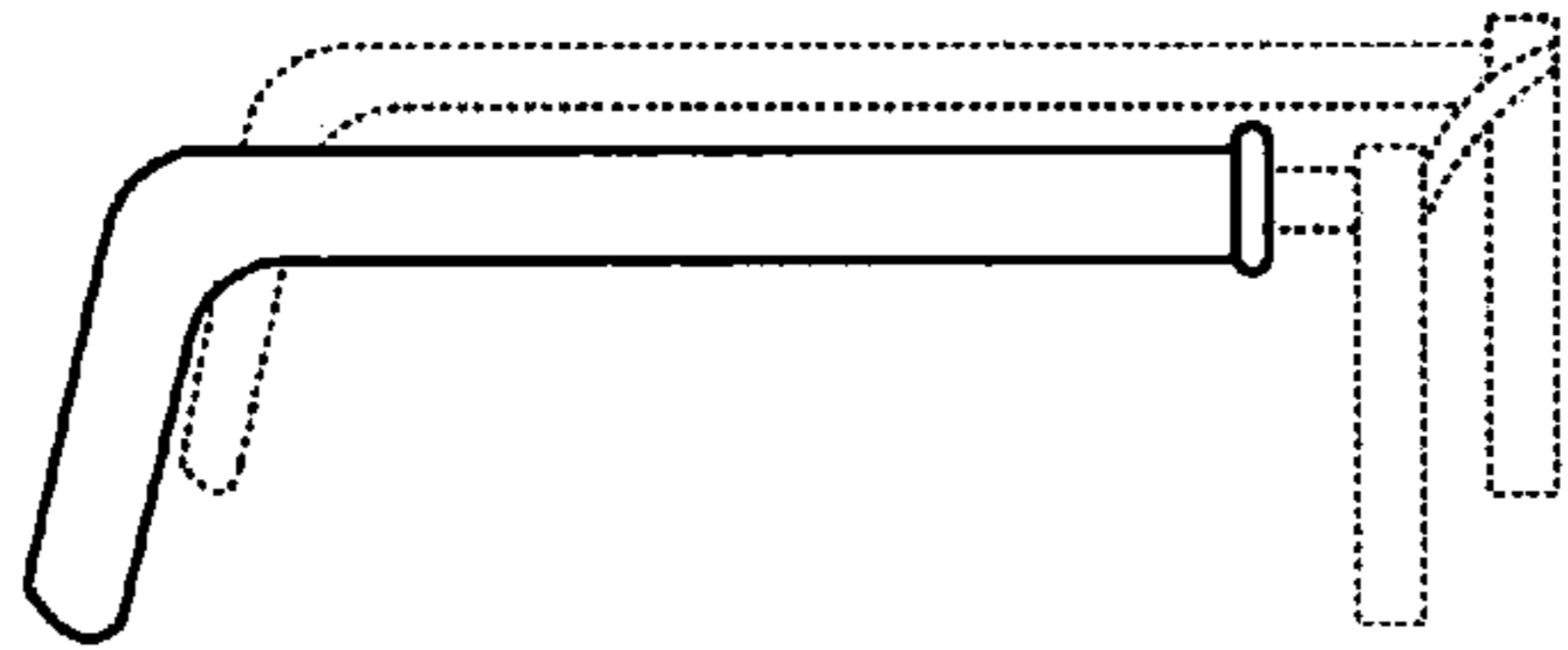

FIG. 1

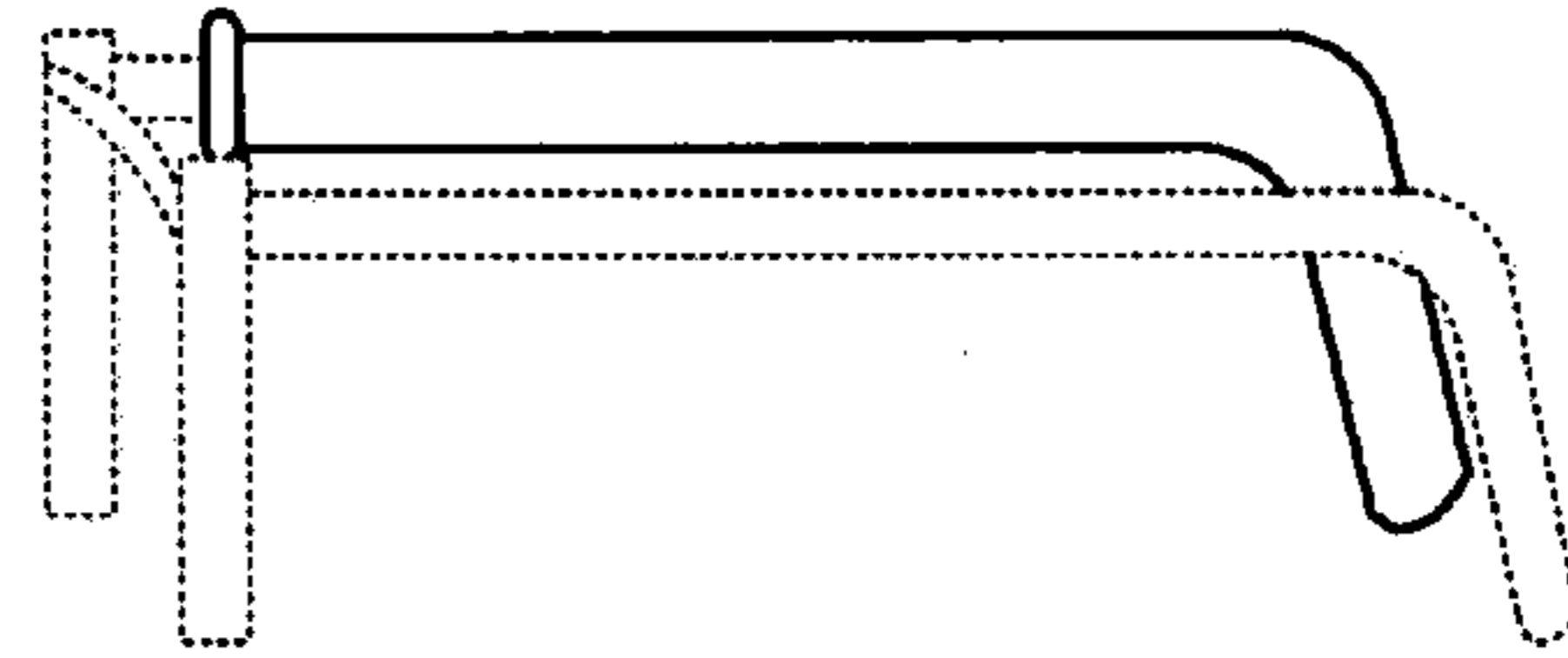

FIG. 2



FIG. 3

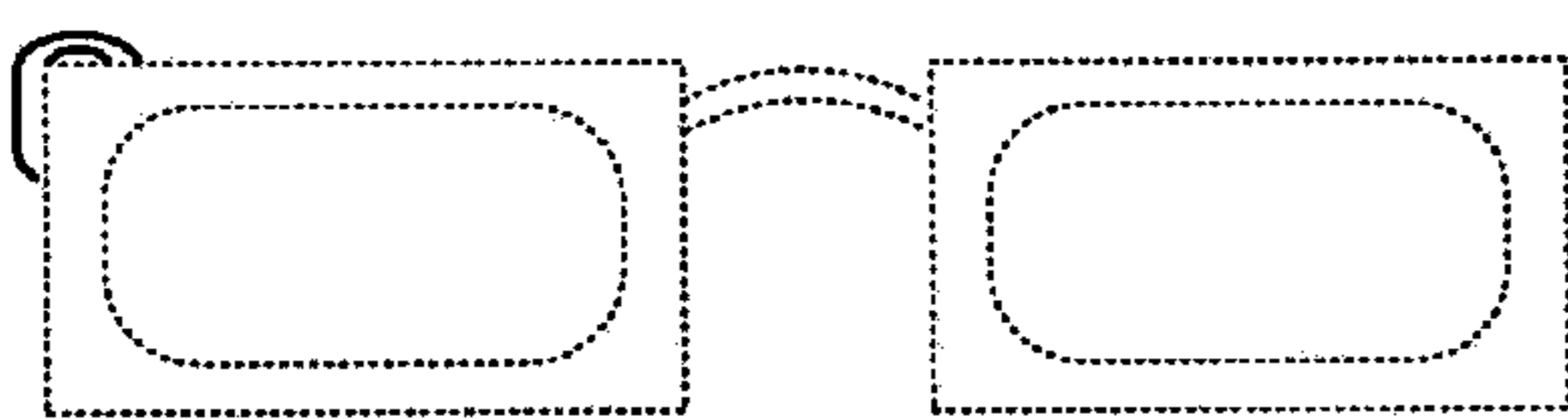

FIG. 4

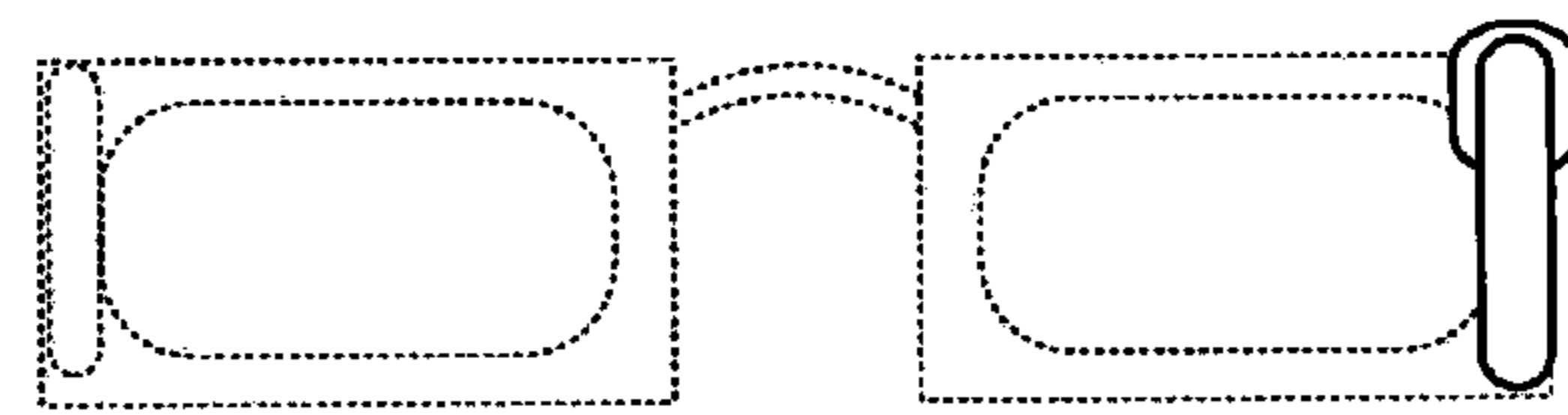

FIG. 5

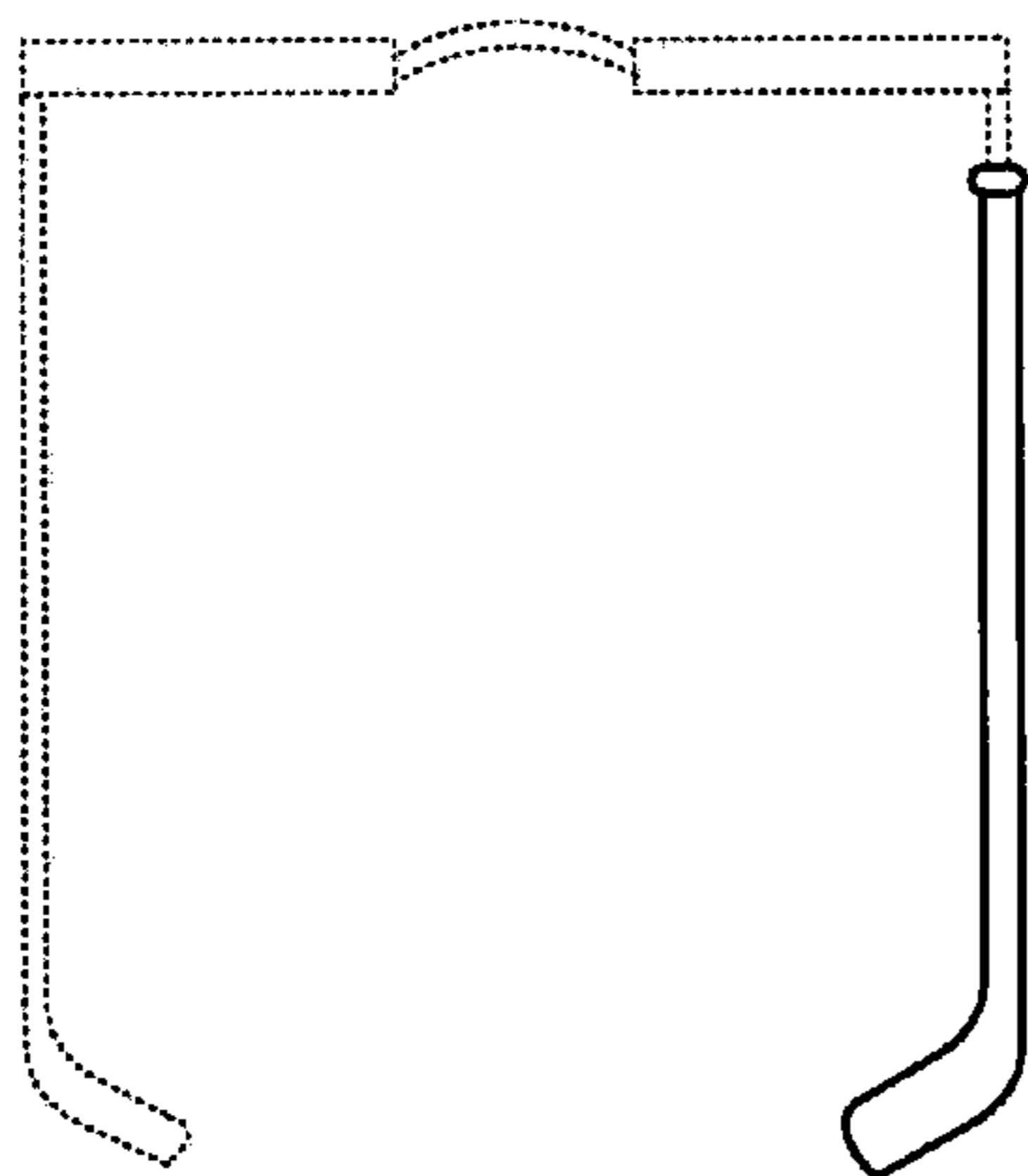

FIG. 6

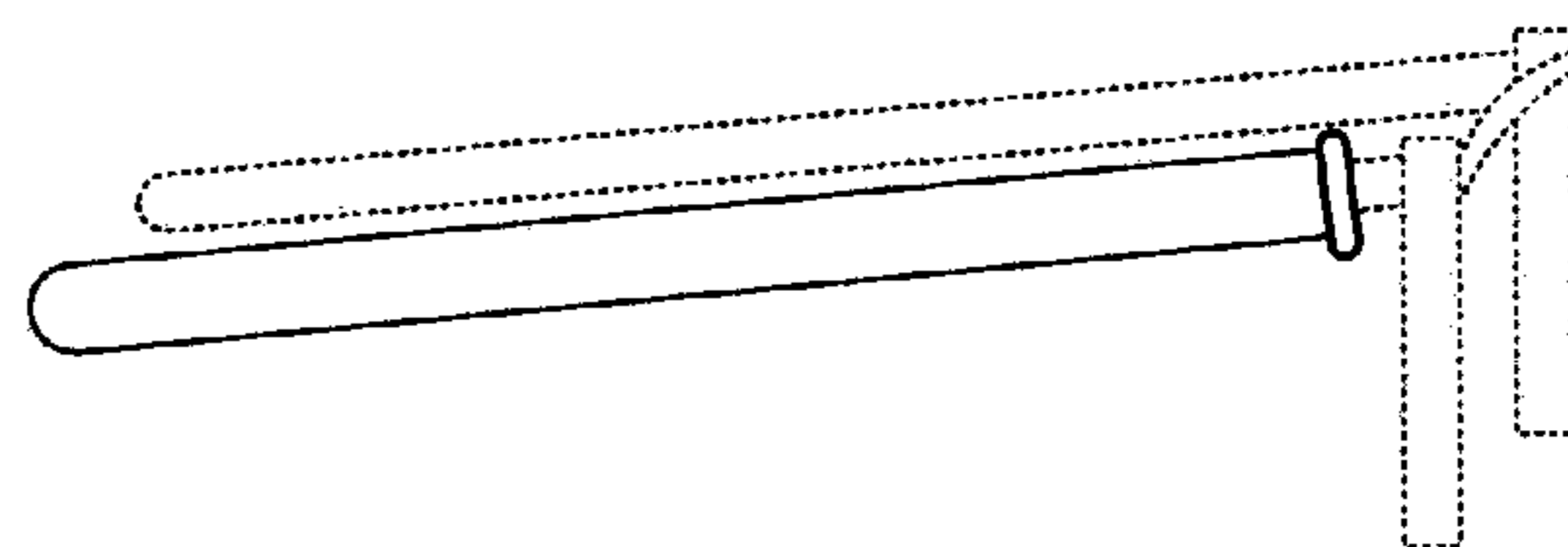

FIG. 7