



US00D593067S

(12) **United States Design Patent**  
**Millora et al.**

(10) **Patent No.:** **US D593,067 S**

(45) **Date of Patent:** **\*\* May 26, 2009**

(54) **WIRELESS HEADSET**

(75) Inventors: **Wesley Millora**, Rancho Dominguez, CA (US); **Alex Chon**, Rancho Dominguez, CA (US); **Rudy Widiaman**, Rancho Dominguez, CA (US); **Hyocheon Ahn**, Rancho Dominguez, CA (US); **Jeff Jones**, Rancho Dominguez, CA (US)

(73) Assignee: **Samsung Electronics Co., Ltd.**, Suwon-Si (KR)

(\*\*) Term: **14 Years**

(21) Appl. No.: **29/324,543**

(22) Filed: **Sep. 15, 2008**

(51) **LOC (9) Cl.** ..... **14-01**

(52) **U.S. Cl.** ..... **D14/205**

(58) **Field of Classification Search** ..... D14/205, D14/206, 223, 188, 192, 168; 379/430, 431; 381/380, 370, 327, 375, 378, 385; 181/130, 181/135; D29/112; 2/209; 455/90.3, 344, 455/565, 569.1, 575.2; D24/106; 128/864, 128/865

See application file for complete search history.

(56) **References Cited**

**U.S. PATENT DOCUMENTS**

2,501,107 A \* 3/1950 Volkman ..... 381/378  
5,034,995 A \* 7/1991 Ciccone ..... 455/344  
5,608,808 A \* 3/1997 da Silva ..... 381/370

5,715,323 A \* 2/1998 Walker ..... 381/385  
5,749,373 A \* 5/1998 Dix ..... 128/864  
6,104,824 A \* 8/2000 Ito ..... 381/381  
6,603,863 B1 \* 8/2003 Nagayoshi ..... 381/380  
D525,235 S \* 7/2006 Koizumi ..... D14/205  
D550,202 S \* 9/2007 Meier et al. .... D14/206  
D575,268 S \* 8/2008 Christopher et al. .... D14/205  
D579,442 S \* 10/2008 Kim et al. .... D14/205

\* cited by examiner

*Primary Examiner*—Paula Greene

(74) *Attorney, Agent, or Firm*—Staas & Halsey LLP

(57) **CLAIM**

The ornamental design for a wireless headset, as shown and described.

**DESCRIPTION**

FIG. 1 is a perspective view of a wireless headset according to our new design;

FIG. 2 is a front elevational view thereof;

FIG. 3 is a rear elevational view thereof;

FIG. 4 is a left side elevational view thereof;

FIG. 5 is a right side elevational view thereof;

FIG. 6 is a top plan view thereof; and,

FIG. 7 is a bottom plan view thereof.

The broken line showing on FIGS. 1–7 is for illustrative purposes only and forms no part of the claimed design.

**1 Claim, 6 Drawing Sheets**

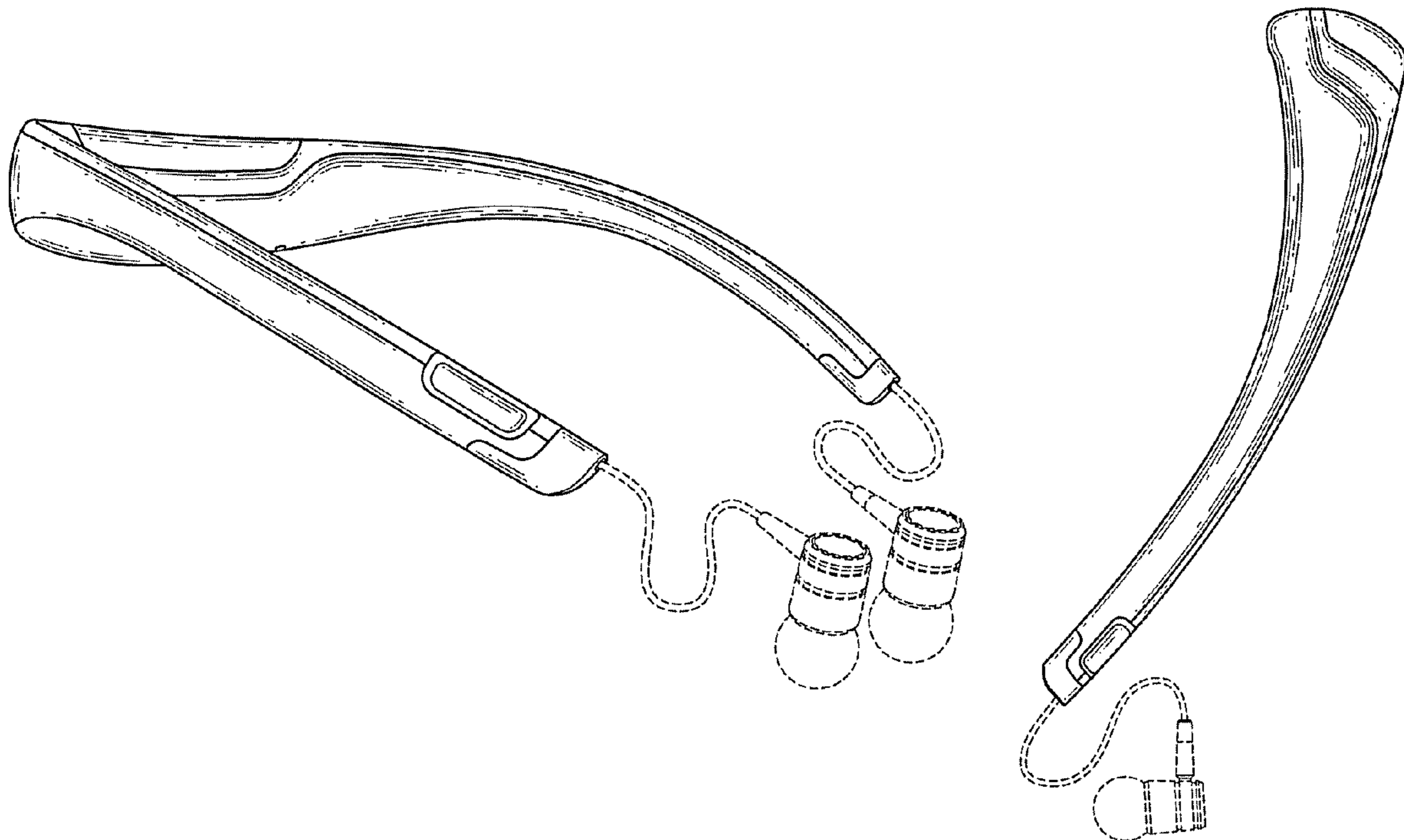

FIG. 1

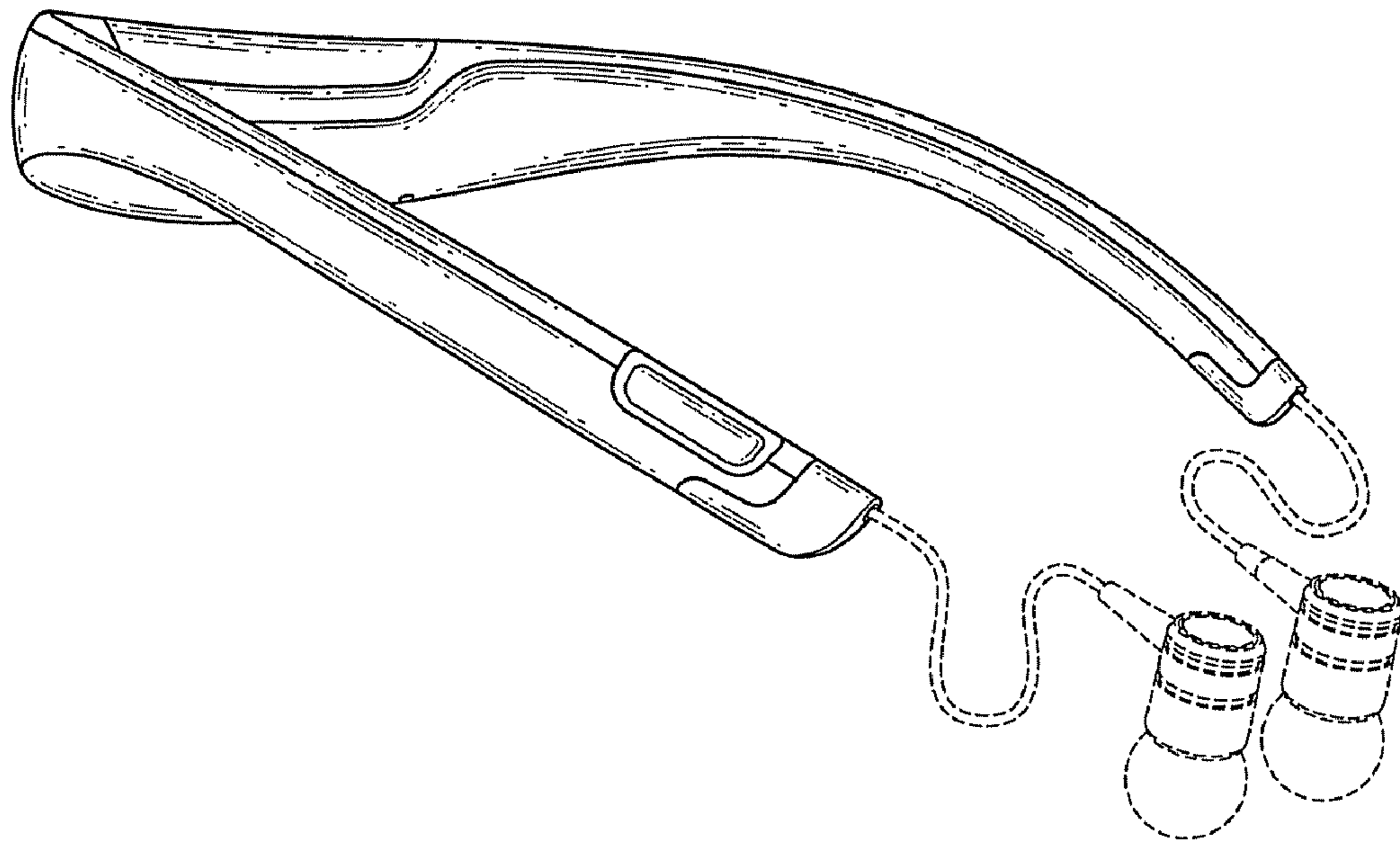

FIG.2

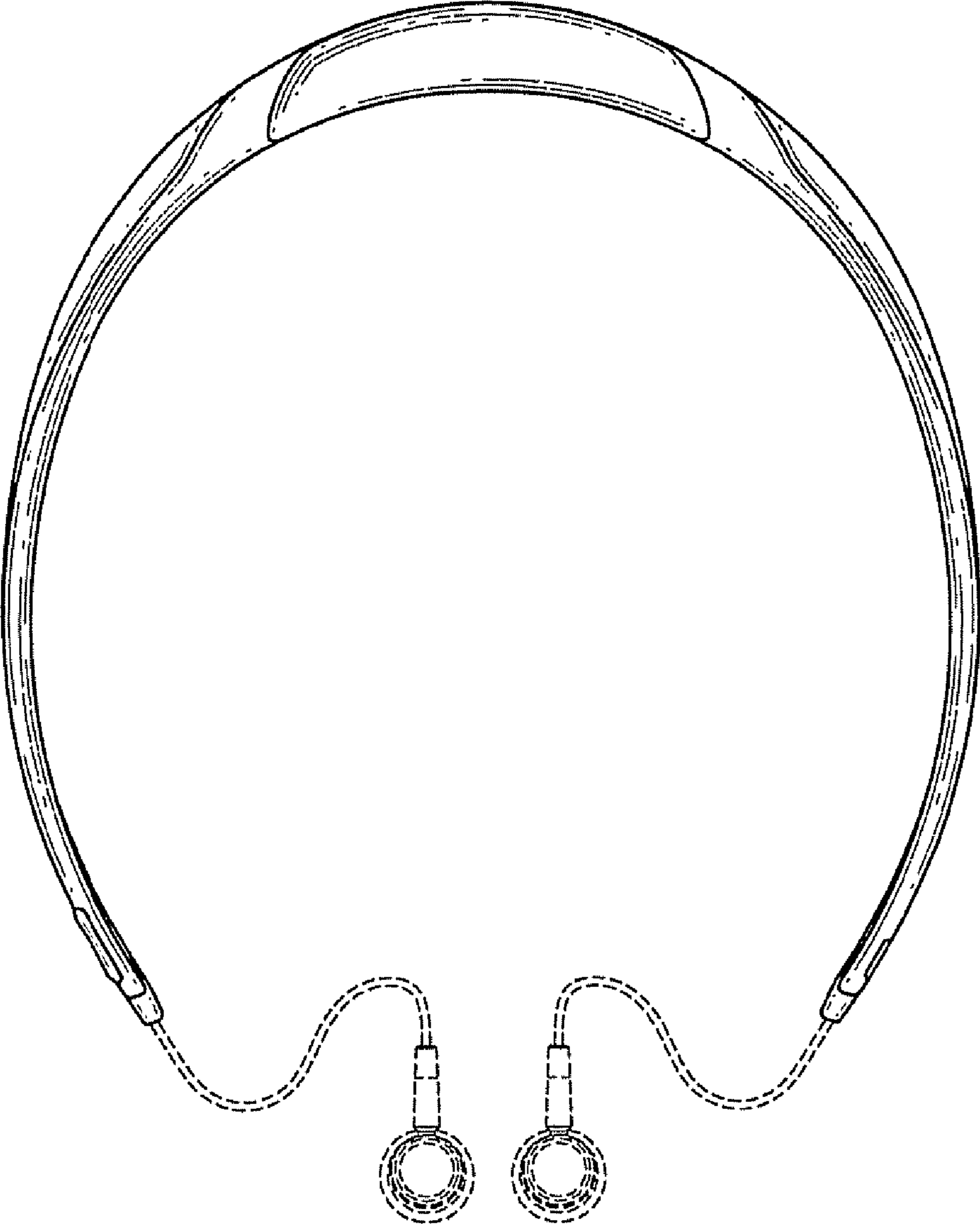

FIG.3

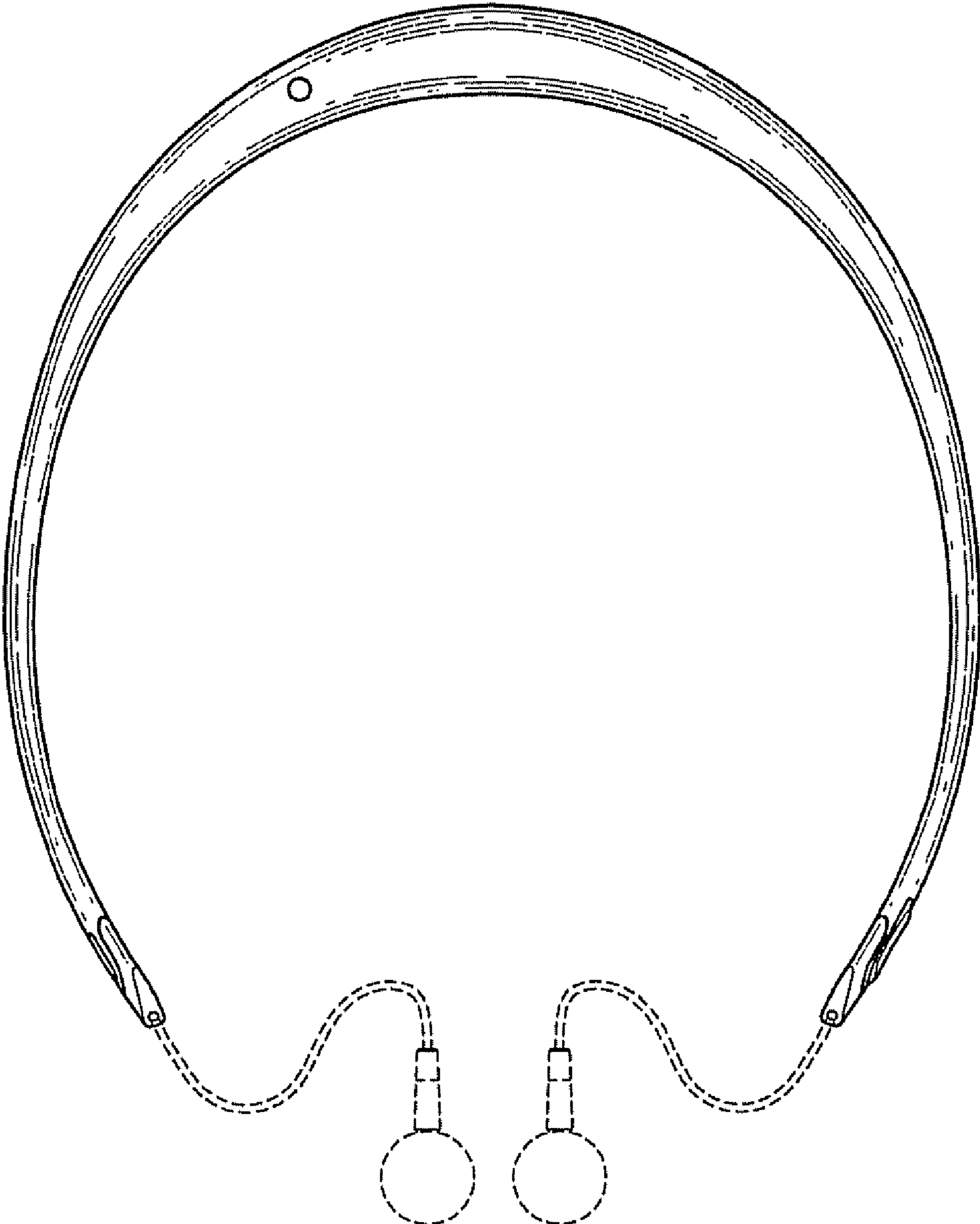

FIG. 4

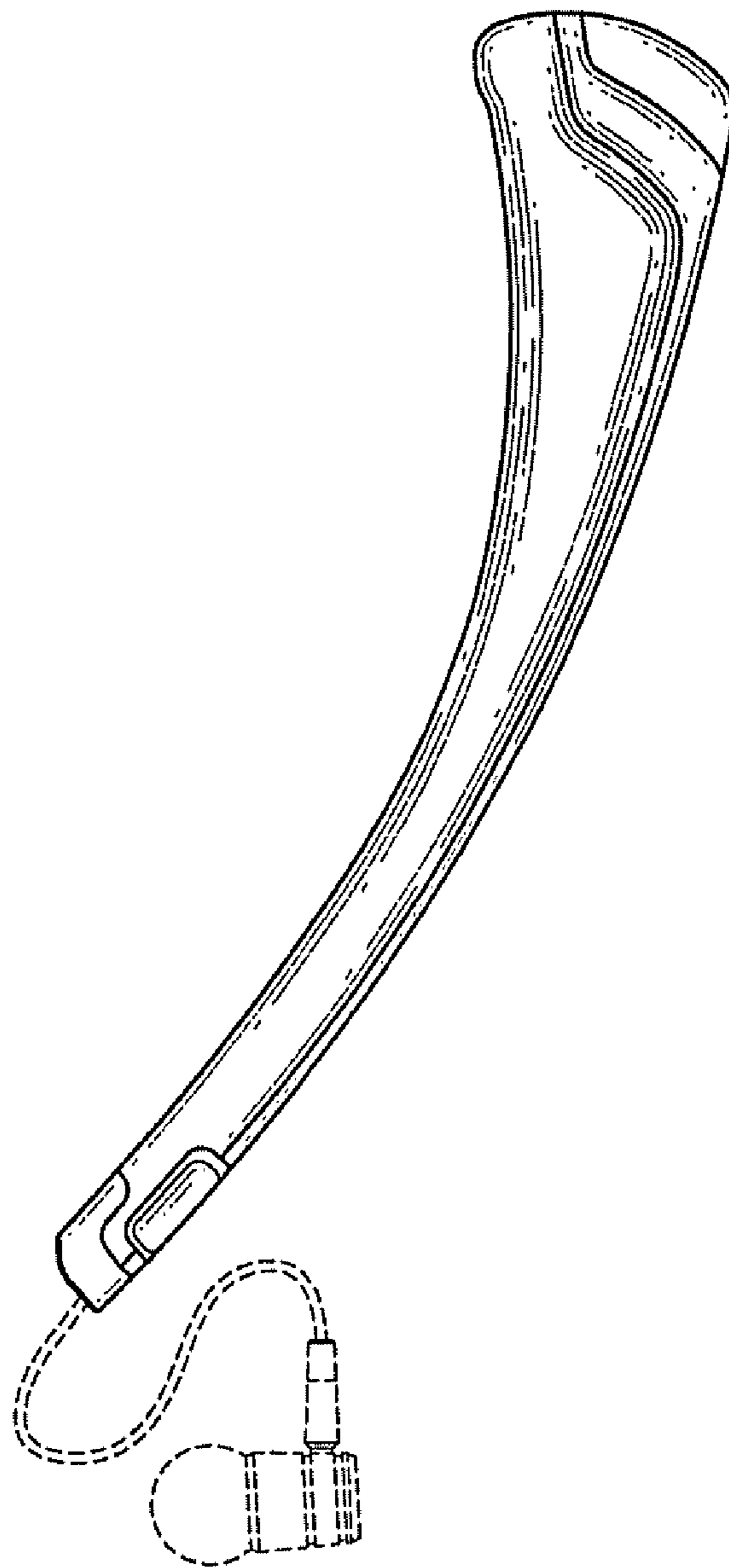

FIG. 5

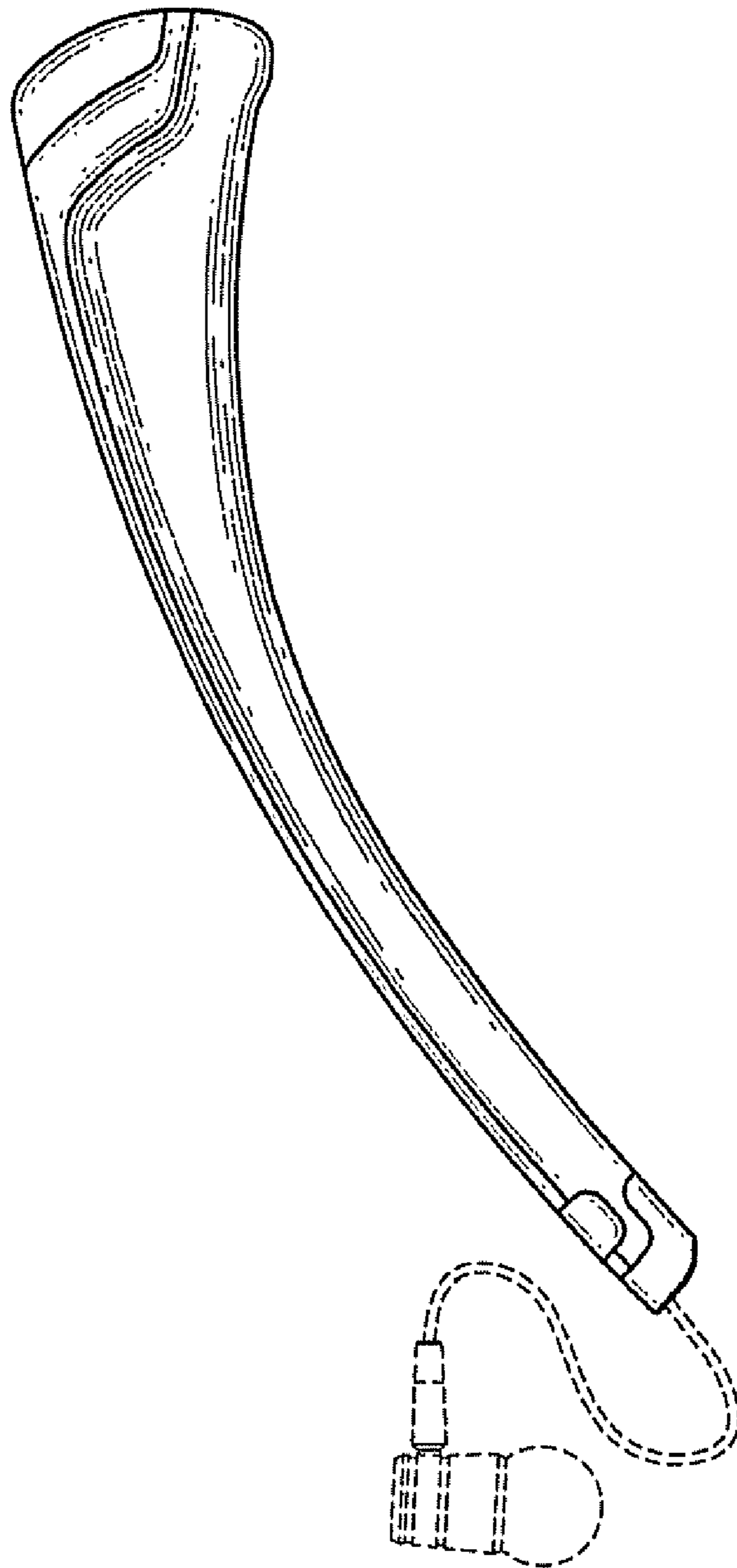

FIG.6

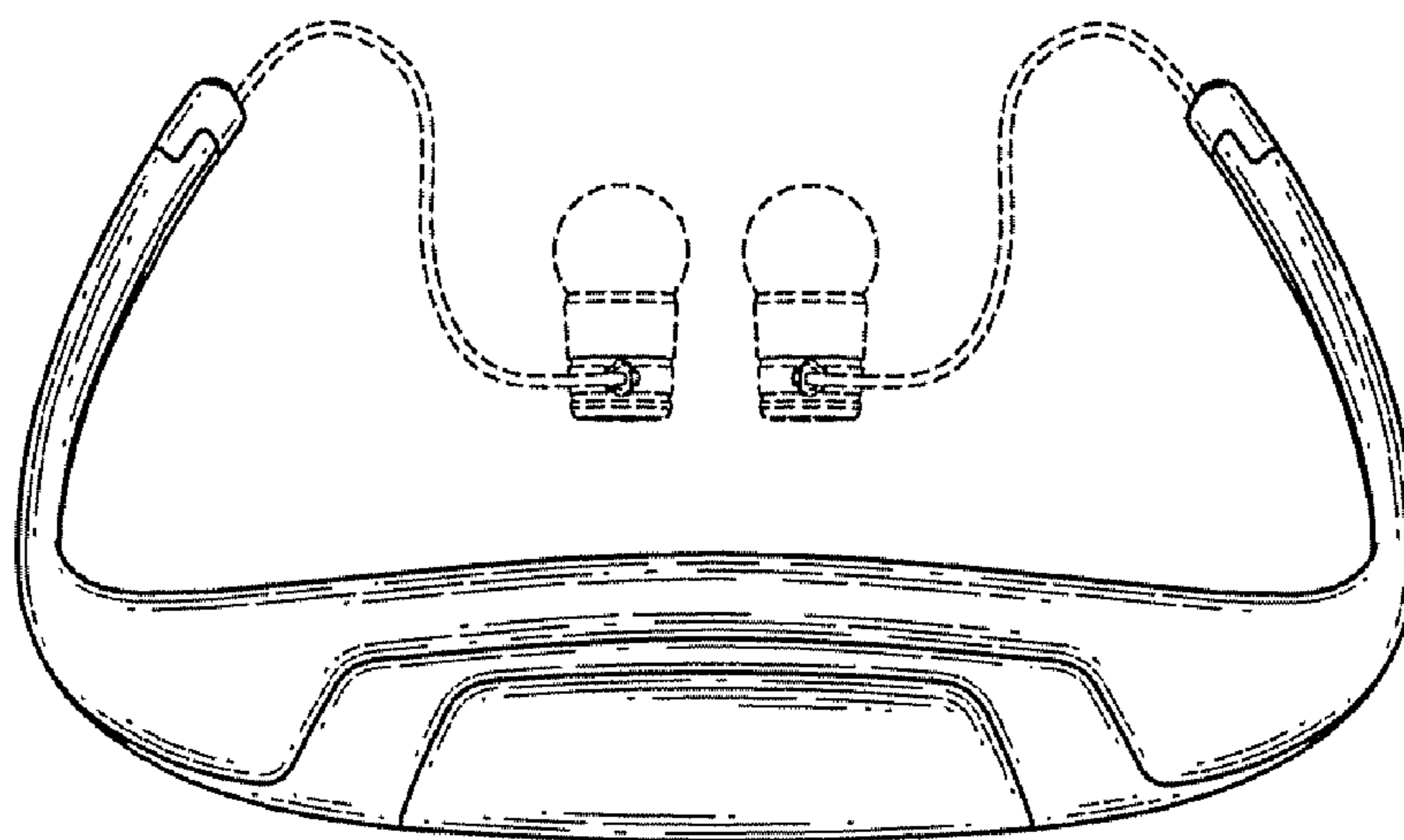

FIG.7

