



US00D593040S

(12) **United States Design Patent**
Frassinetti et al.

(10) **Patent No.:** **US D593,040 S**
(45) **Date of Patent:** **** May 26, 2009**

(54) **ELECTRICAL CIRCUIT BREAKER**

D547,729 S 7/2007 Azzola et al.
D547,730 S 7/2007 Azzola et al.
D551,629 S 9/2007 Azzola et al.
D562,777 S 2/2008 Azzola et al.

(75) Inventors: **Giovanni Frassinetti**, Bergamo (IT);
Lucio Azzola, Bergamo (IT)

(73) Assignee: **ABB S.p.A.**, Milan (IT)

(**) Term: **14 Years**

(21) Appl. No.: **29/325,302**

(22) Filed: **Sep. 29, 2008**

Related U.S. Application Data

(63) Continuation of application No. 29/303,446, filed on Feb. 8, 2008, now abandoned.

Foreign Application Priority Data

(30) Aug. 9, 2007 (EM) 000771688-0001

(51) **LOC (9) Cl.** **13-03**

(52) **U.S. Cl.** **D13/160**

(58) **Field of Classification Search** D13/123,
D13/133, 158, 159, 160, 184, 199; 200/43.14,
200/50.01, 50.21-50.23, 51 R, 293, 400,
200/401; 361/42, 44, 45, 50, 71, 115, 608,
361/634

See application file for complete search history.

(56) **References Cited**

U.S. PATENT DOCUMENTS

D303,655 S 9/1989 Gonzales et al.
D347,623 S 6/1994 Suzuki et al.
D378,914 S 4/1997 Smith et al.
5,906,271 A 5/1999 Castonguay et al.
D425,870 S 5/2000 Torrez
D506,185 S 6/2005 Kim
D535,626 S 1/2007 Azzola et al.

FOREIGN PATENT DOCUMENTS

WO WO-DM-055273 4/2001

OTHER PUBLICATIONS

Abb Sace L.V., Sace Emax A system that's open to any solution, 604060/011 en, Jul. 1999.

Terasaki Electric, Revolution in circuit breaker technology, 35 pp.

Primary Examiner—Daniel D Bui

Assistant Examiner—Thomas J Johannes

(74) *Attorney, Agent, or Firm*—Connolly Bove Lodge & Hutz LLP

(57) **CLAIM**

The ornamental design for “electrical circuit breaker,” as shown and described.

DESCRIPTION

FIG. 1 is an isometric view of an electrical circuit breaker, showing our new design;

FIG. 2 is a front view thereof;

FIG. 3 is a top view thereof;

FIG. 4 is a bottom view thereof;

FIG. 5 is a left view thereof;

FIG. 6 is a right view thereof; and,

FIG. 7 is a rear view thereof.

The broken line portion of the figure drawings is included to show unclaimed subject matter only and forms no part of the claimed design.

1 Claim, 7 Drawing Sheets

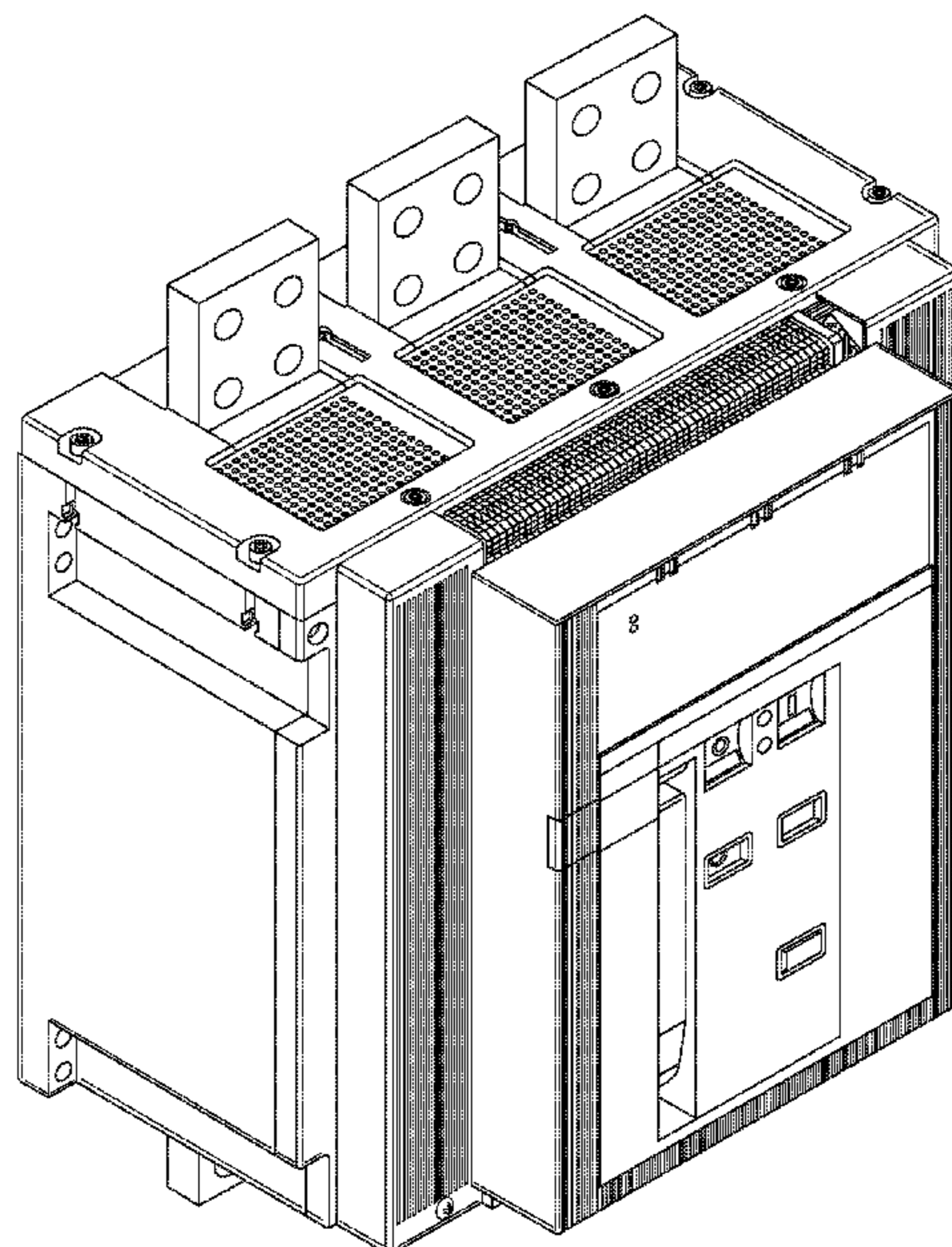

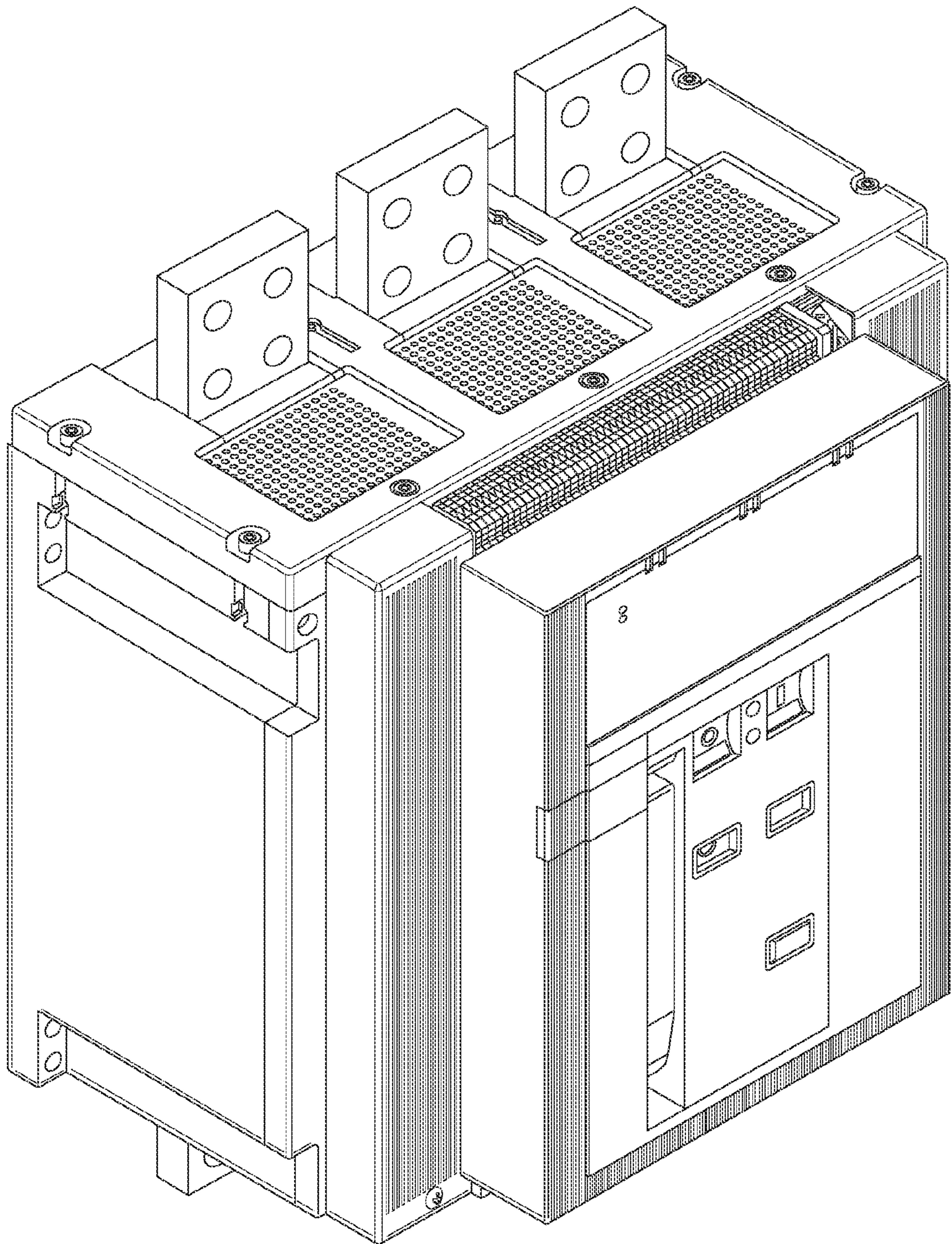

FIG. 1

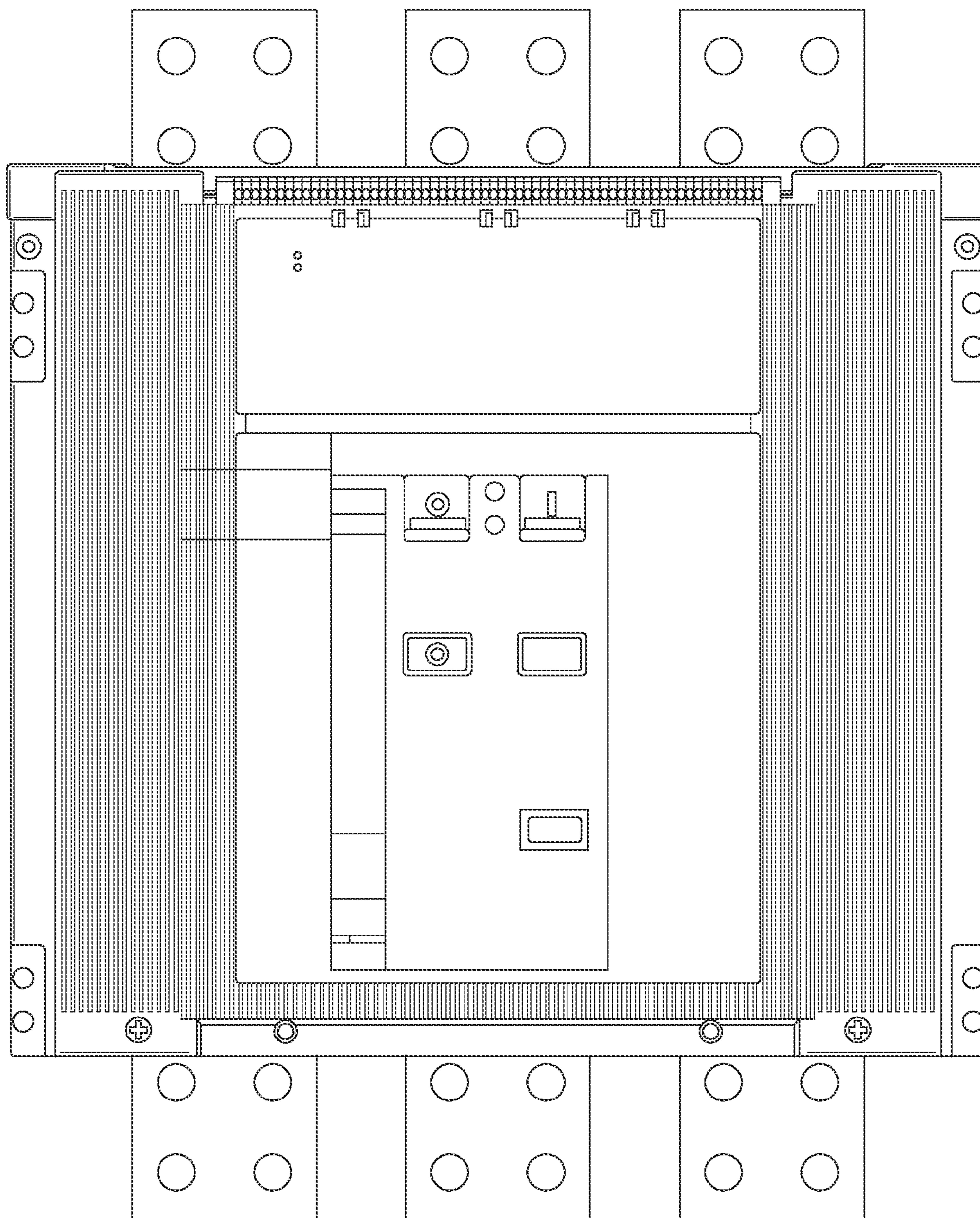

FIG. 2

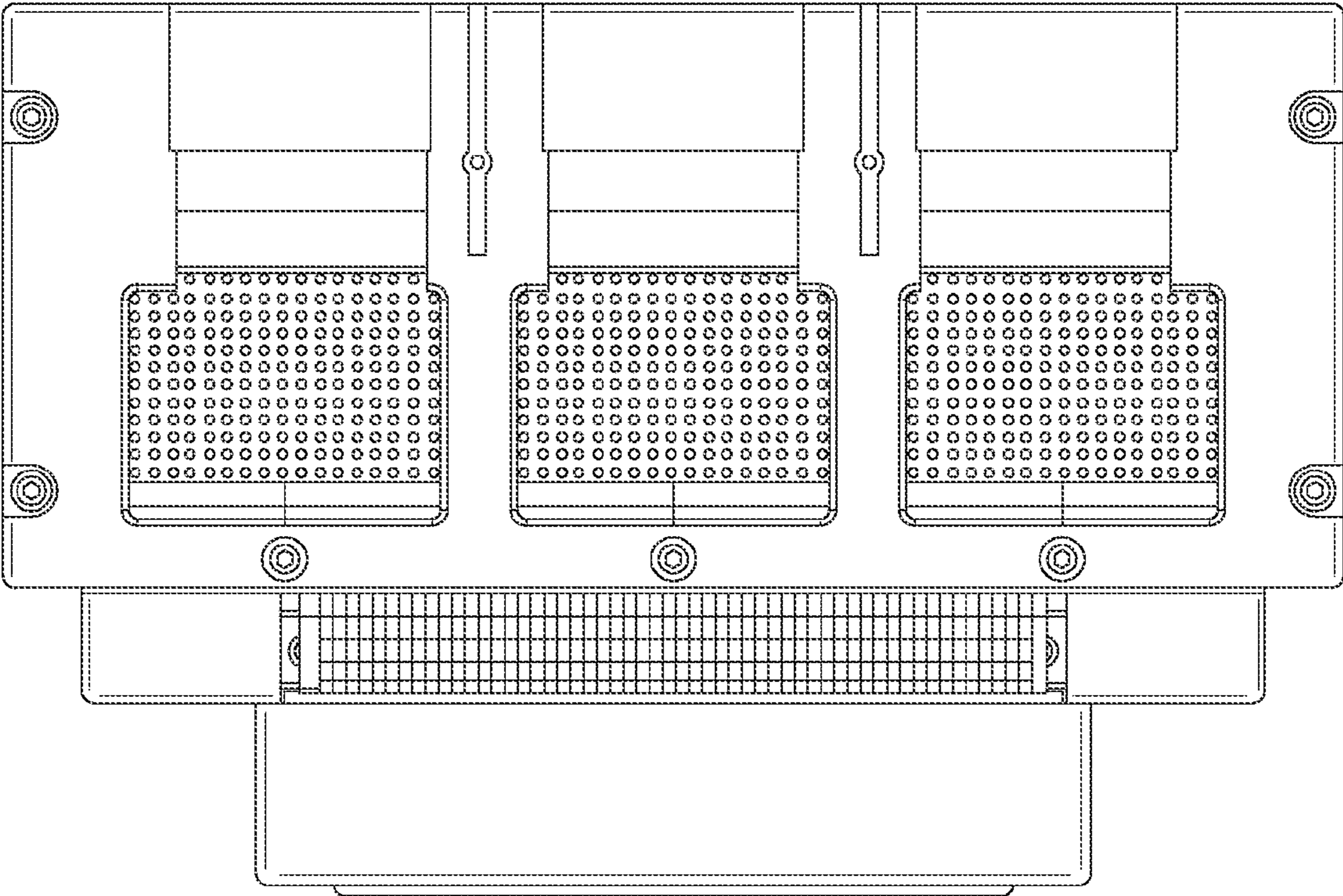

FIG. 3

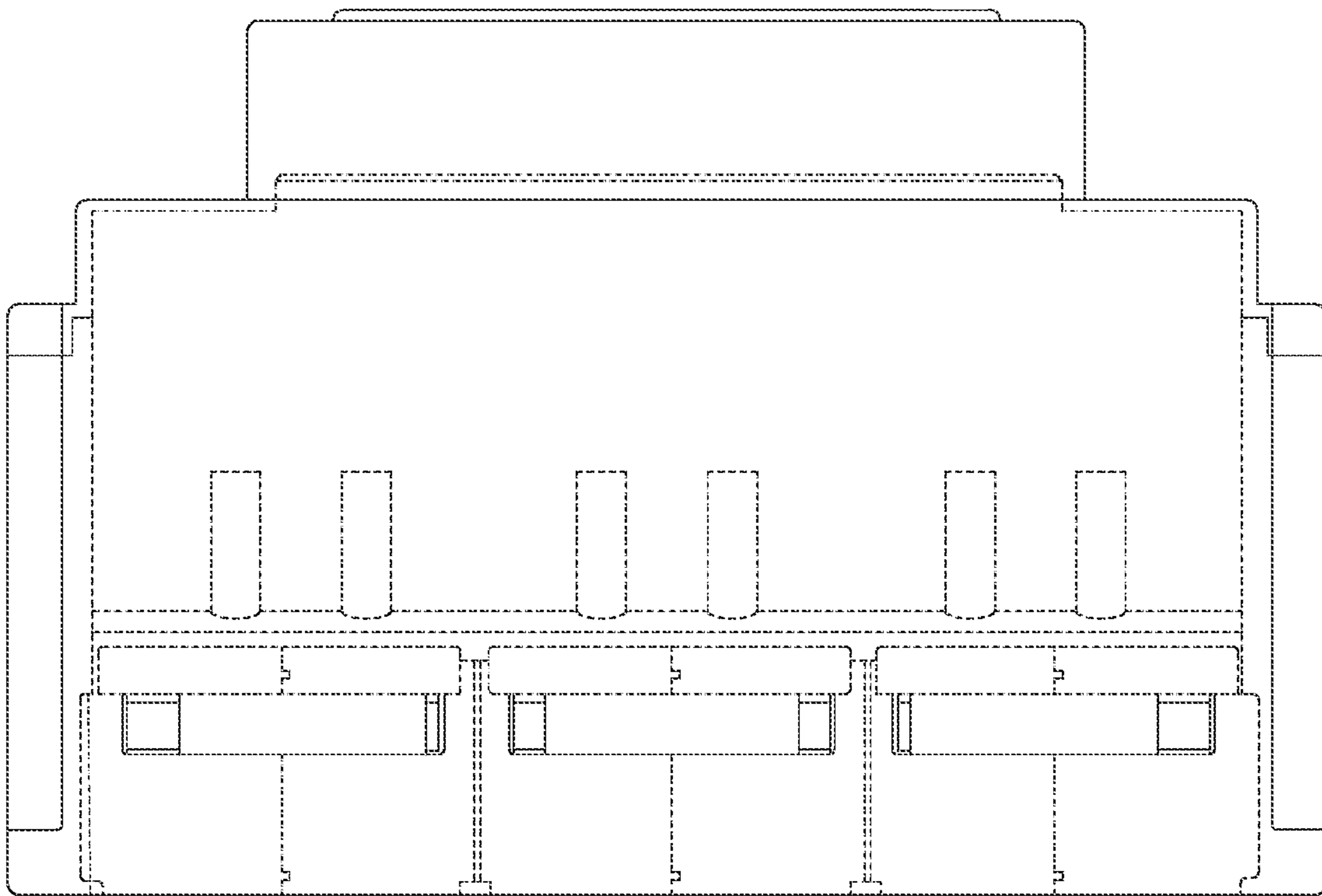

FIG. 4

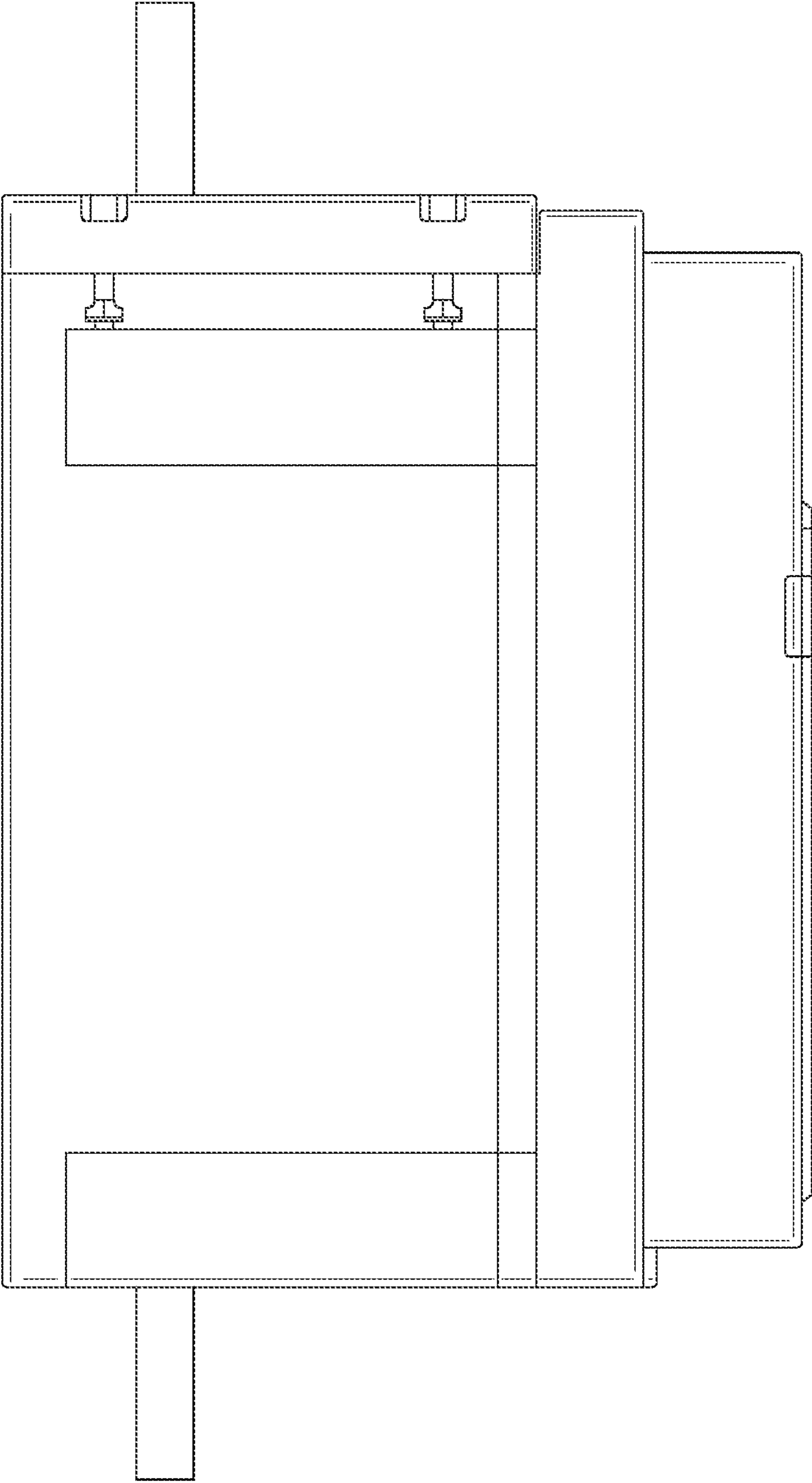

FIG. 5

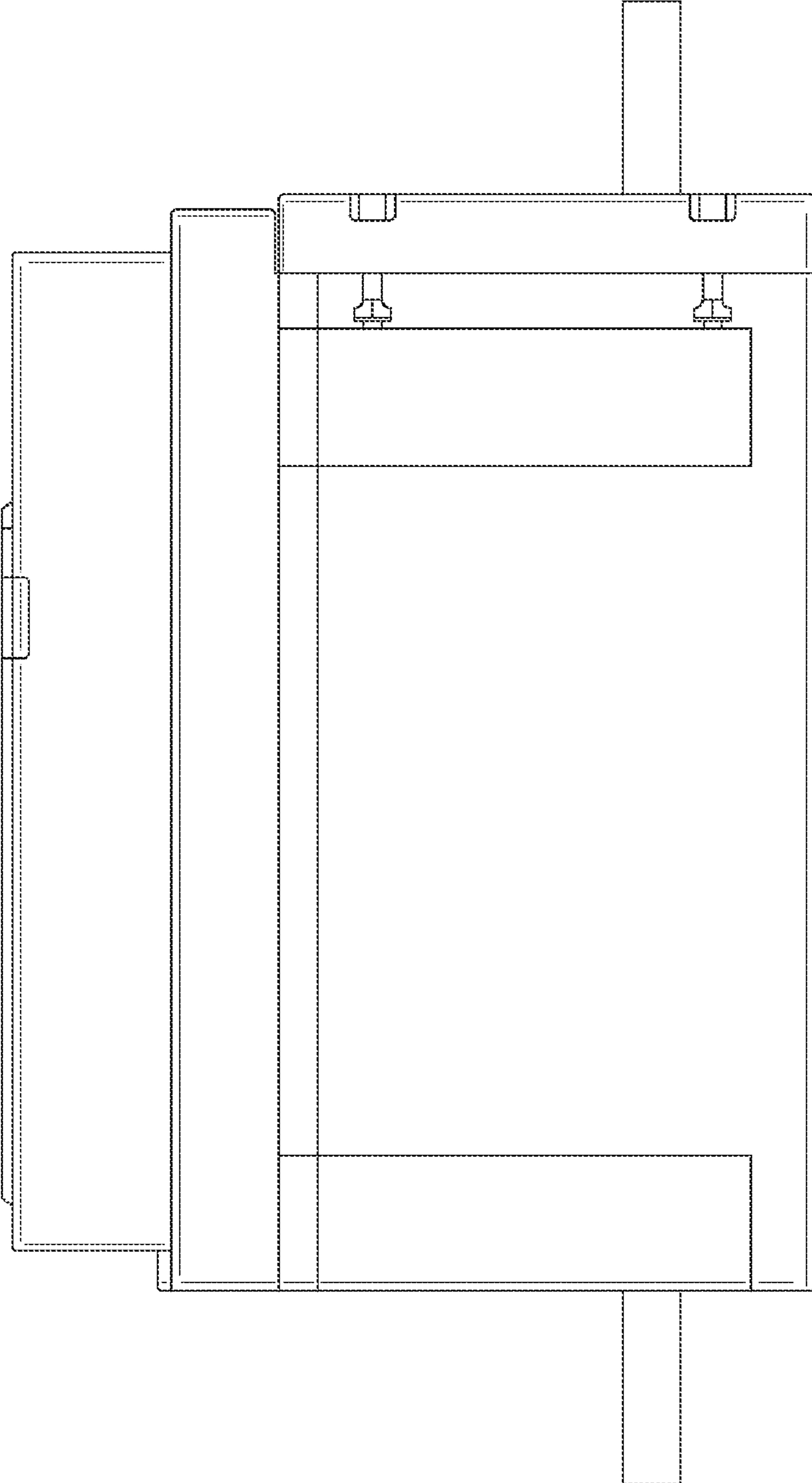

FIG. 6

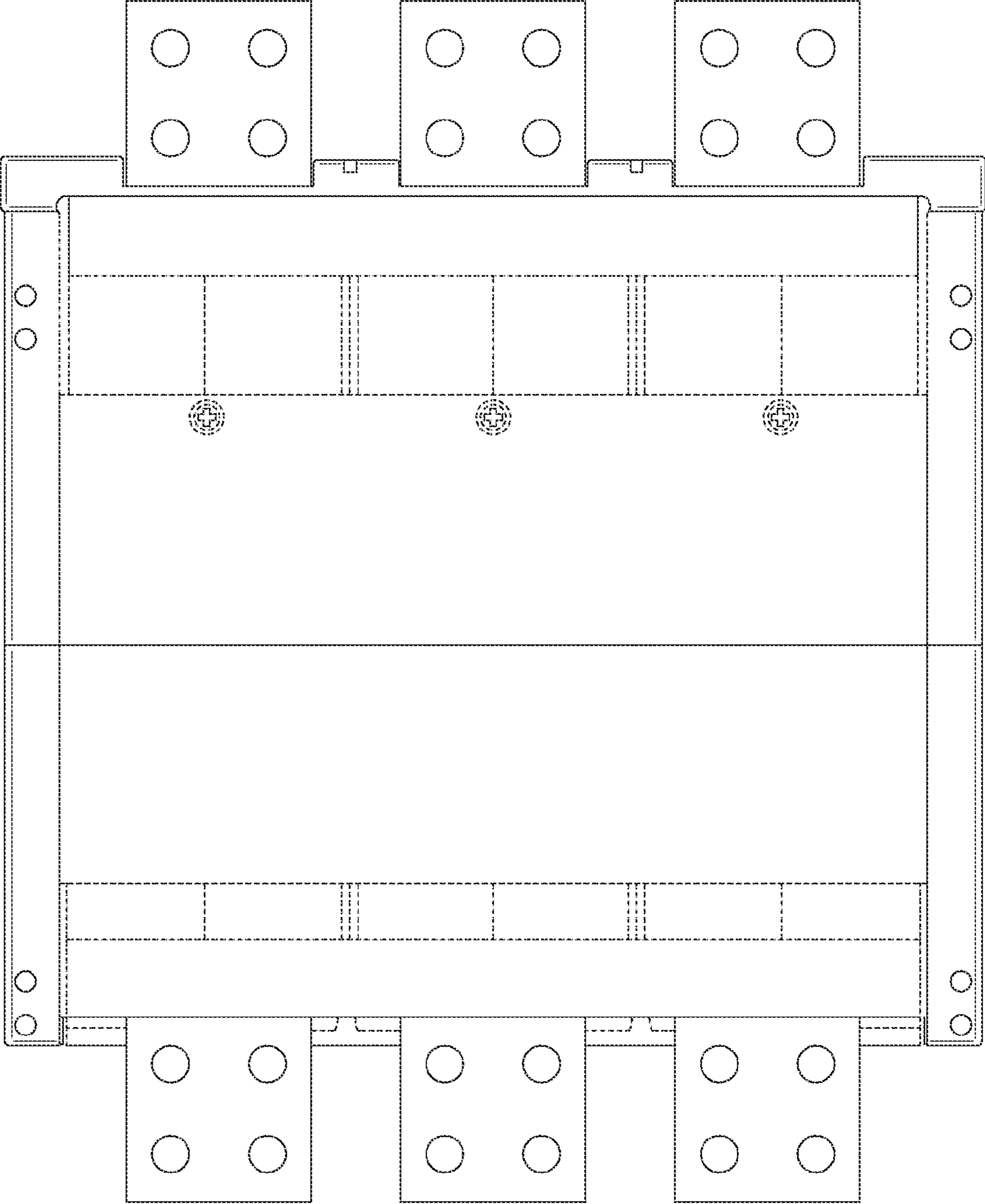

FIG. 7