



US00D592933S

(12) **United States Design Patent**
Jones et al.

(10) **Patent No.:** **US D592,933 S**
(45) **Date of Patent:** **** May 26, 2009**

(54) **DOOR HANDLE PULL AND ESCUTCHEON**

(75) Inventors: **Sherry L. Jones**, Pataskala, OH (US);
Kevin J. Vititoe, Columbus, OH (US)

(73) Assignee: **Truth Hardware Corporation**,
Owatonna, MN (US)

(**) Term: **14 Years**

(21) Appl. No.: **29/279,294**

(22) Filed: **Apr. 25, 2007**

(51) **LOC (9) Cl.** **08-06**

(52) **U.S. Cl.** **D8/302; D8/301**

(58) **Field of Classification Search** D8/300–303,
D8/305–321, DIG. 1, DIG. 2, DIG. 10, 350,
D8/353; D7/393, 394, 405; D3/318; D6/549,
D6/524, 533, 550; D23/250–254, 303, 305;
D15/89; 292/347, 336.3, 36, 65; 211/16,
211/182; 220/752–754; 16/441, 118, 110 R,
16/111 R, DIG. 19, DIG. 30, 110.1, 412,
16/414–420, 443–446; 70/95–100

See application file for complete search history.

(56) **References Cited**

U.S. PATENT DOCUMENTS

- D72,725 S 5/1927 Rosenthal
- D176,085 S 11/1955 Stone
- D196,563 S 10/1963 Clayton
- D199,612 S 11/1964 Foster
- 3,381,990 A * 5/1968 Kreger 292/62
- D261,726 S * 11/1981 Valli D8/301
- D270,994 S * 10/1983 Tegner D8/316
- D297,505 S 9/1988 Mosch
- D316,807 S 5/1991 Paulson et al.
- D320,334 S * 10/1991 Clancy D8/301
- D330,839 S * 11/1992 Barrington et al. D8/315
- 5,210,905 A * 5/1993 Dietz et al. 16/429
- D340,398 S * 10/1993 Clancy D8/302
- D350,890 S * 9/1994 Boeri D8/302
- D351,980 S * 11/1994 Molteni D8/302
- D370,167 S * 5/1996 Edwards D8/320
- D384,266 S * 9/1997 Mantarakis et al. D8/301

- D384,568 S * 10/1997 Mantarakis et al. D8/301
- D384,573 S * 10/1997 Lee D8/318
- D389,722 S * 1/1998 Blom D8/319
- D397,604 S * 9/1998 Libby et al. D8/301
- D417,831 S * 12/1999 Libby et al. D8/302
- 6,023,952 A * 2/2000 Mantarakis et al. 70/99
- D423,321 S * 4/2000 Maier D8/302
- D427,878 S * 7/2000 Frey D8/302
- D431,994 S * 10/2000 Libby et al. D8/301
- D433,916 S * 11/2000 Frey D8/302
- D447,927 S * 9/2001 LaPlume et al. D8/302
- D448,647 S * 10/2001 Goldsbury D8/319
- D452,130 S * 12/2001 Richardson D8/319
- D466,787 S * 12/2002 Clancy D8/301
- D467,784 S * 12/2002 Maier D8/301
- D470,389 S * 2/2003 Richardson D8/319
- D482,592 S * 11/2003 Thuma D8/315
- 6,641,186 B2 * 11/2003 Tsai 292/357
- D500,242 S * 12/2004 Keller et al. D8/318
- D501,392 S * 2/2005 Roberts et al. D8/315
- D509,420 S * 9/2005 Hauber D8/300
- 6,945,572 B1 * 9/2005 Hauber 292/97
- D511,670 S * 11/2005 Chen D8/301
- D514,423 S * 2/2006 Timothy D8/300
- D517,395 S * 3/2006 Alchin D8/330
- D521,351 S * 5/2006 Alchin D8/301
- D523,725 S * 6/2006 Chen D8/301
- D531,482 S * 11/2006 Chen D8/302
- D546,160 S * 7/2007 Reithmeyer D8/301
- D551,534 S * 9/2007 Liang et al. D8/301
- D572,996 S * 7/2008 Nolte et al. D8/302

* cited by examiner

Primary Examiner—Stella M Reid

Assistant Examiner—Mark A Goodwin

(74) *Attorney, Agent, or Firm*—Patterson, Thunte, Skaar & Christensen, PA

(57) **CLAIM**

We claim the ornamental design for door handle pull and escutcheon, as shown and described.

DESCRIPTION

FIG. 1 is a front perspective view of a door handle pull and escutcheon according to a first embodiment of the invention;

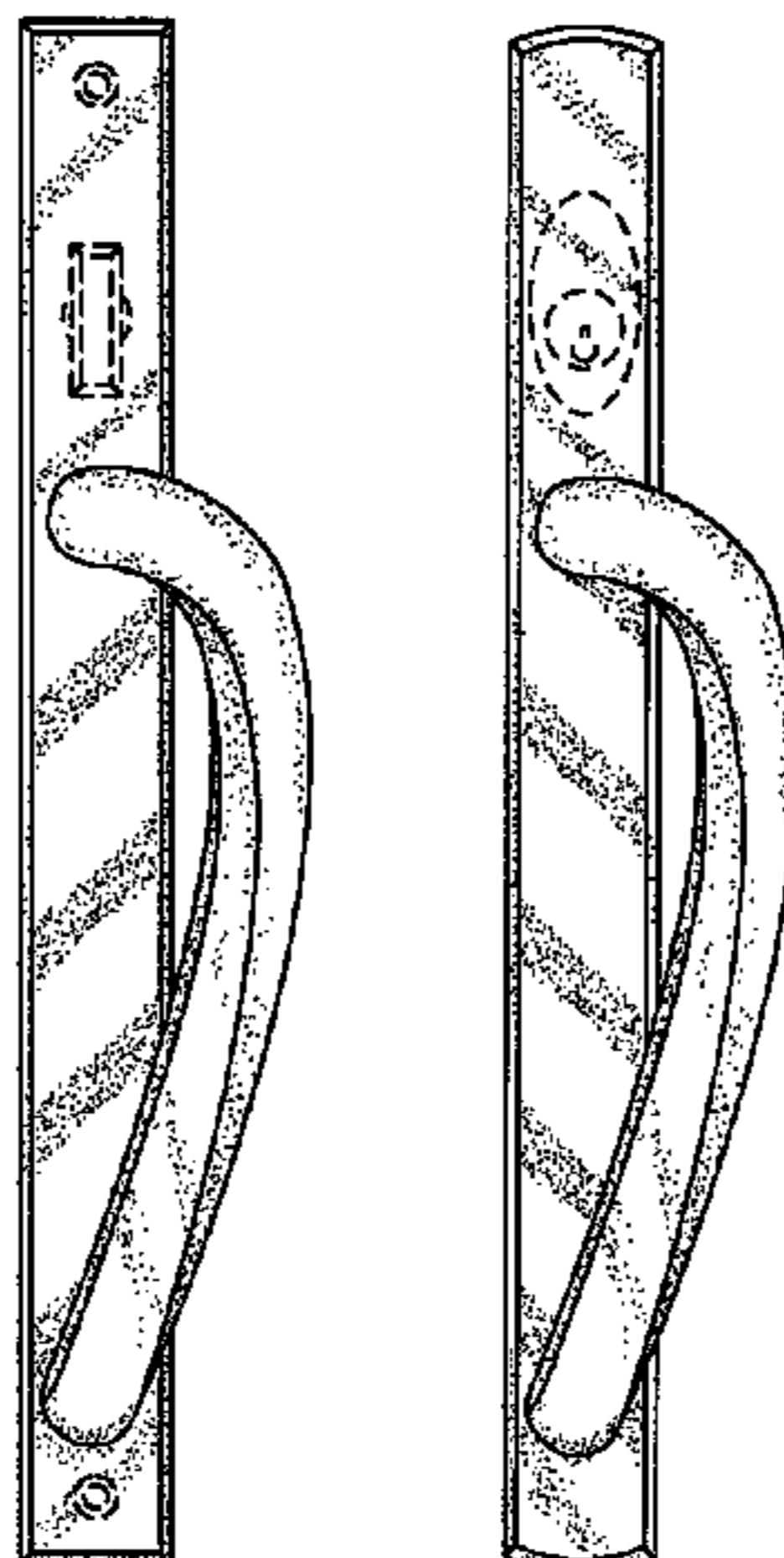

FIG. 2 is a rear elevation view of the door handle pull and escutcheon depicted in FIG. 1;

FIG. 3 is a side elevation view of the door handle pull and escutcheon depicted in FIG. 1;

FIG. 4 is an opposing side elevation view of the door handle pull and escutcheon depicted in FIG. 1;

FIG. 5 is a front elevation view of the door handle pull and escutcheon depicted in FIG. 1;

FIG. 6 is a top plan view of the door handle pull and escutcheon depicted in FIG. 1;

FIG. 7 is a bottom plan view of the door handle pull and escutcheon depicted in FIG. 1;

FIG. 8 is a front perspective view of a door handle pull and escutcheon according to a second embodiment of the invention;

FIG. 9 is a rear elevation view of the door handle pull and escutcheon depicted in FIG. 8;

FIG. 10 is a side elevation view of the door handle pull and escutcheon depicted in FIG. 8;

FIG. 11 is an opposing side elevation view of the door handle pull and escutcheon depicted in FIG. 8;

FIG. 12 is a front elevation view of the door handle pull and escutcheon depicted in FIG. 8;

FIG. 13 is a top plan view of the door handle pull and escutcheon depicted in FIG. 8;

FIG. 14 is a bottom plan view of the door handle pull and escutcheon depicted in FIG. 8;

FIG. 15 is a front elevation view of a door handle pull and escutcheon according to a third embodiment of the invention;

FIG. 16 is a side elevation view of the door handle pull and escutcheon depicted in FIG. 15;

FIG. 17 is an opposing side elevation view of the door handle pull and escutcheon depicted in FIG. 15;

FIG. 18 is a rear elevation view of the door handle pull and escutcheon depicted in FIG. 15;

FIG. 19 is a top plan view of the door handle pull and escutcheon depicted in FIG. 15;

FIG. 20 is a bottom plan view of the door handle pull and escutcheon depicted in FIG. 15;

FIG. 21 is a front elevation view of a door handle pull and escutcheon according to a fourth embodiment of the invention;

FIG. 22 is a side elevation view of the door handle pull and escutcheon depicted in FIG. 21;

FIG. 23 is an opposing side elevation view of the door handle pull and escutcheon depicted in FIG. 21;

FIG. 24 is a rear elevation view of the door handle pull and escutcheon depicted in FIG. 21;

FIG. 25 is a top plan view of the door handle pull and escutcheon depicted in FIG. 21;

FIG. 26 is a bottom plan view of the door handle pull and escutcheon depicted in FIG. 21;

FIG. 27 is a front elevation view of a door handle pull and escutcheon according to a fifth embodiment of the invention;

FIG. 28 is a side elevation view of the door handle pull and escutcheon depicted in FIG. 27;

FIG. 29 is an opposing side elevation view of the door handle pull and escutcheon depicted in FIG. 27;

FIG. 30 is a rear elevation view of the door handle pull and escutcheon depicted in FIG. 27;

FIG. 31 is a top plan view of the door handle pull and escutcheon depicted in FIG. 27;

FIG. 32 is a bottom plan view of the door handle pull and escutcheon depicted in FIG. 27;

FIG. 33 is a front elevation view of a door handle pull and escutcheon according to a sixth embodiment of the invention;

FIG. 34 is a side elevation view of the door handle pull and escutcheon depicted in FIG. 33;

FIG. 35 is an opposing side elevation view of the door handle pull and escutcheon depicted in FIG. 33;

FIG. 36 is a rear elevation view of the door handle pull and escutcheon depicted in FIG. 33;

FIG. 37 is a top plan view of the door handle pull and escutcheon depicted in FIG. 33;

FIG. 38 is a bottom plan view of the door handle pull and escutcheon depicted in FIG. 33;

FIG. 39 is a front elevation view of a door handle pull and escutcheon according to a seventh embodiment of the invention;

FIG. 40 is a side elevation view of the door handle pull and escutcheon depicted in FIG. 39;

FIG. 41 is an opposing side elevation view of the door handle pull and escutcheon depicted in FIG. 39;

FIG. 42 is a rear elevation view of the door handle pull and escutcheon depicted in FIG. 39;

FIG. 43 is a top plan view of the door handle pull and escutcheon depicted in FIG. 39;

FIG. 44 is a bottom plan view of the door handle pull and escutcheon depicted in FIG. 39;

FIG. 45 is a front elevation view of a door handle pull and escutcheon according to an eighth embodiment of the invention;

FIG. 46 is a side elevation view of the door handle pull and escutcheon depicted in FIG. 45;

FIG. 47 is an opposing side elevation view of the door handle pull and escutcheon depicted in FIG. 45;

FIG. 48 is a rear elevation view of the door handle pull and escutcheon depicted in FIG. 45;

FIG. 49 is a top plan view of the door handle pull and escutcheon depicted in FIG. 45; and,

FIG. 50 is a bottom plan view of the door handle pull and escutcheon depicted in FIG. 45.

The broken line depiction of structure is included for the purpose of illustrating environment and forms no part of the claimed design.

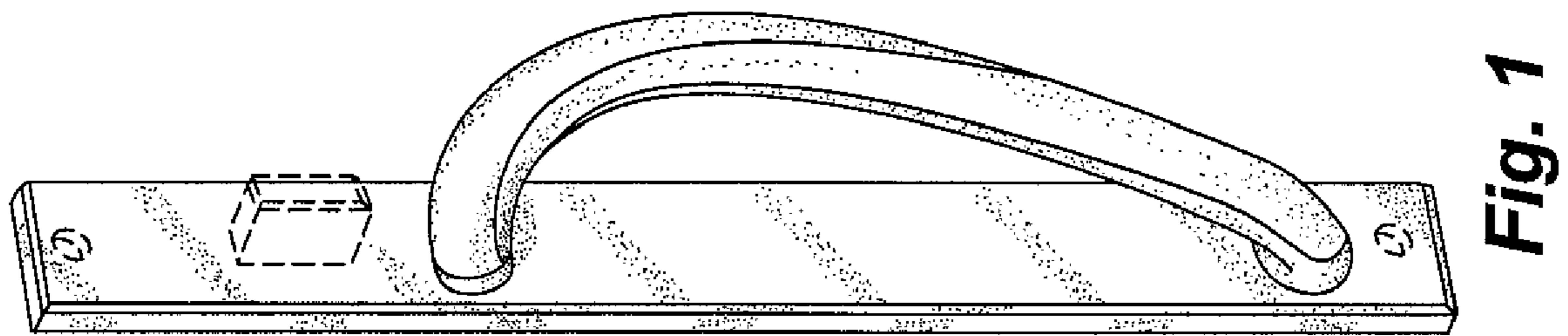

Fig. 1

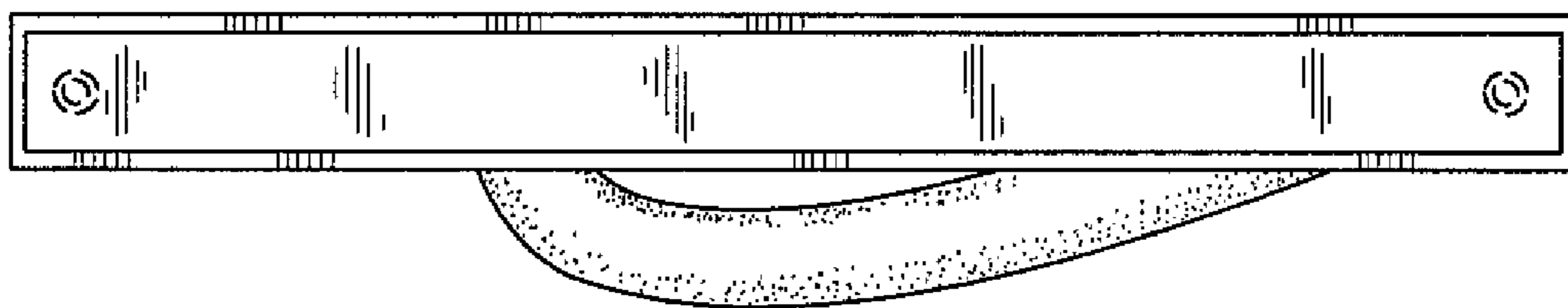

Fig. 2



Fig. 3

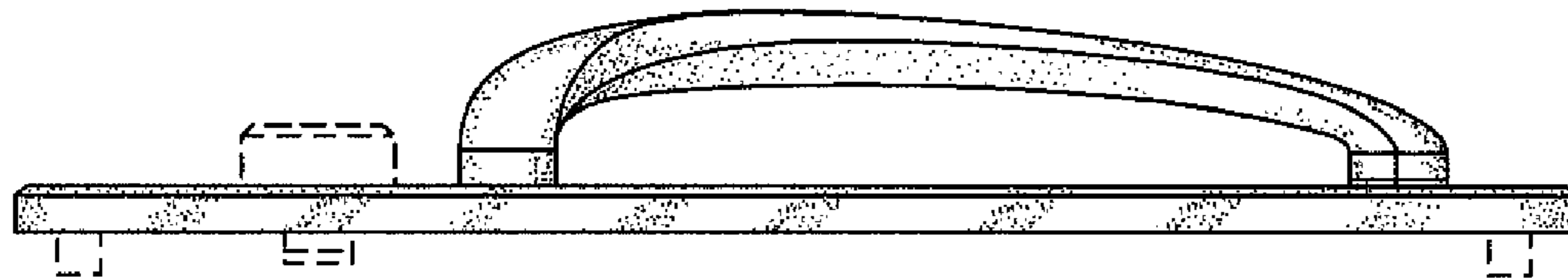

Fig. 4

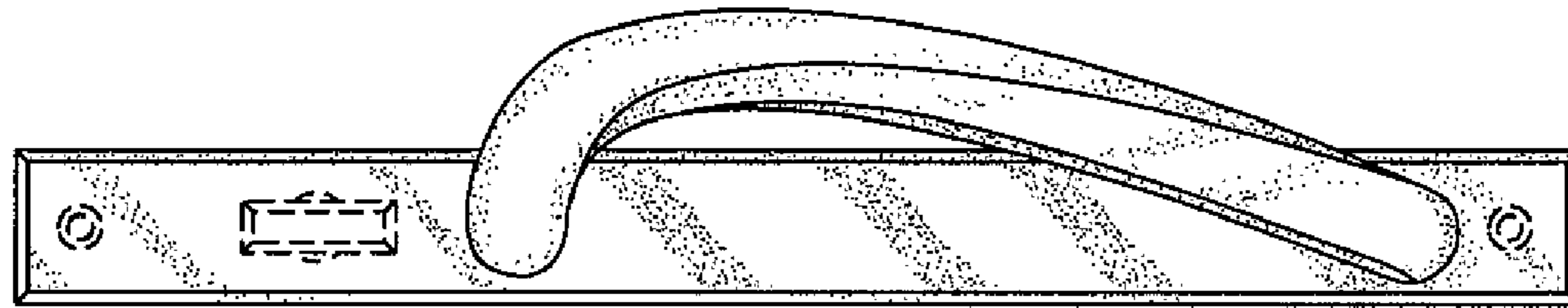

Fig. 5

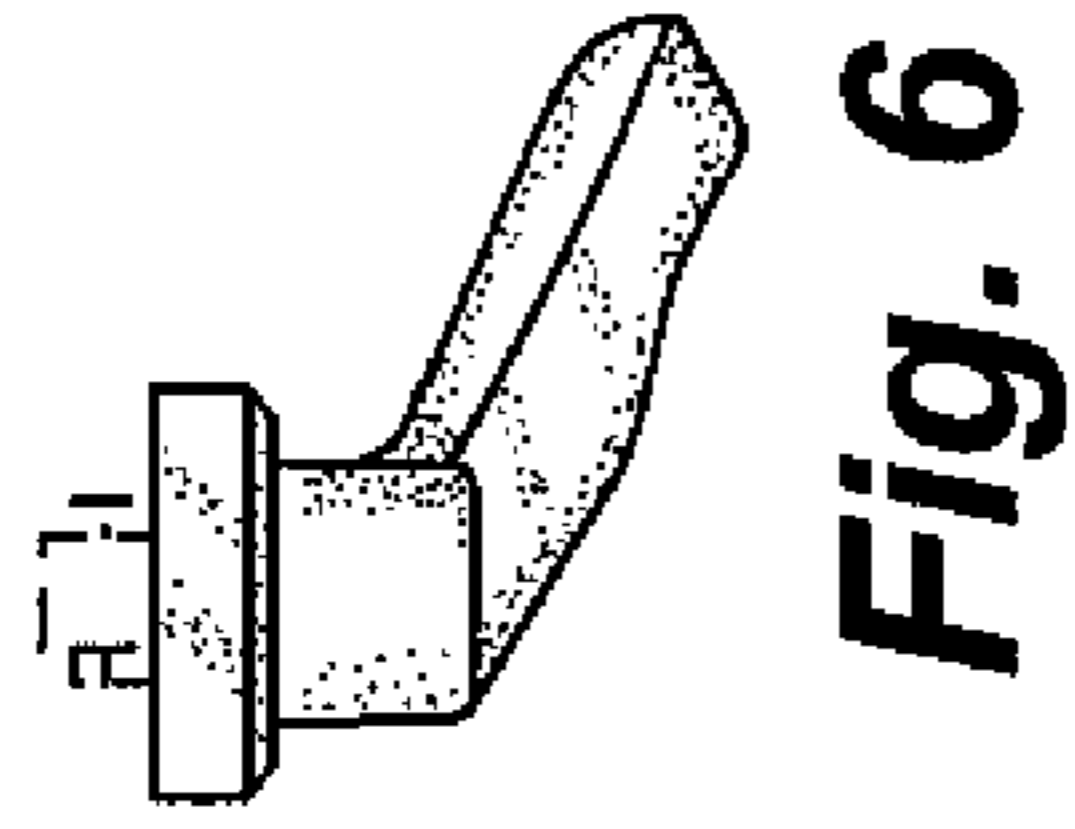

Fig. 6

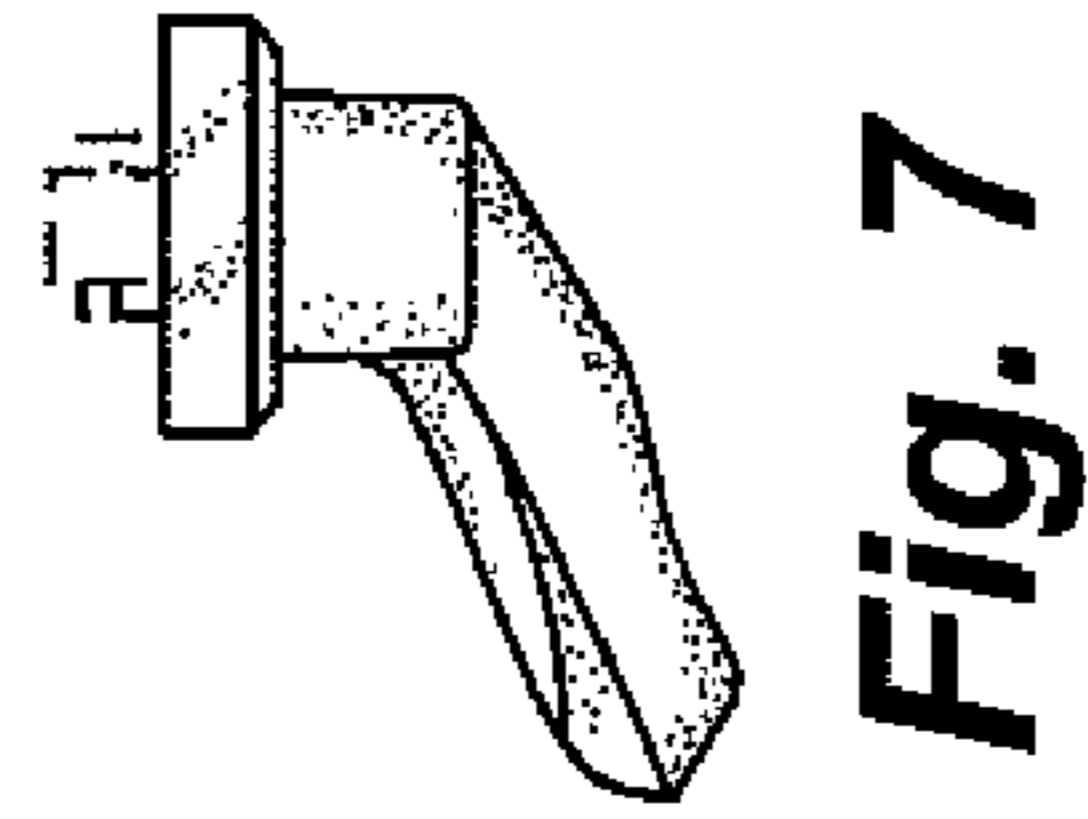

Fig. 7

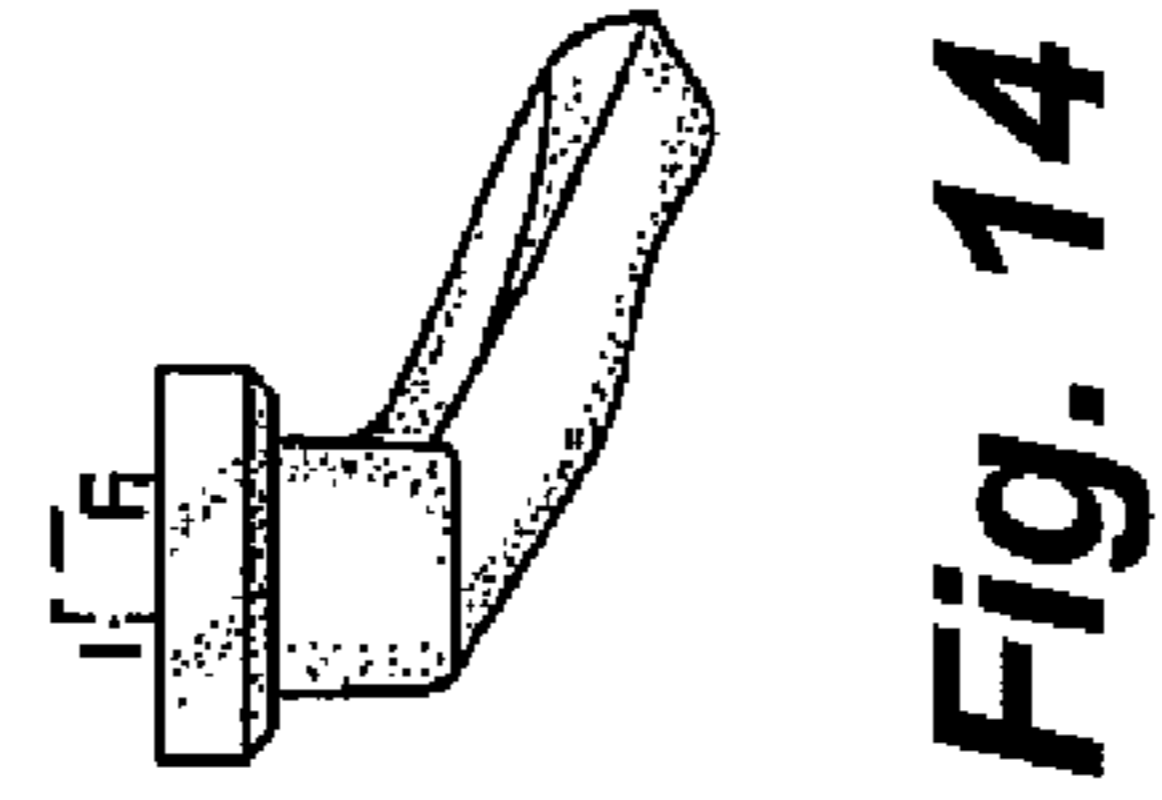
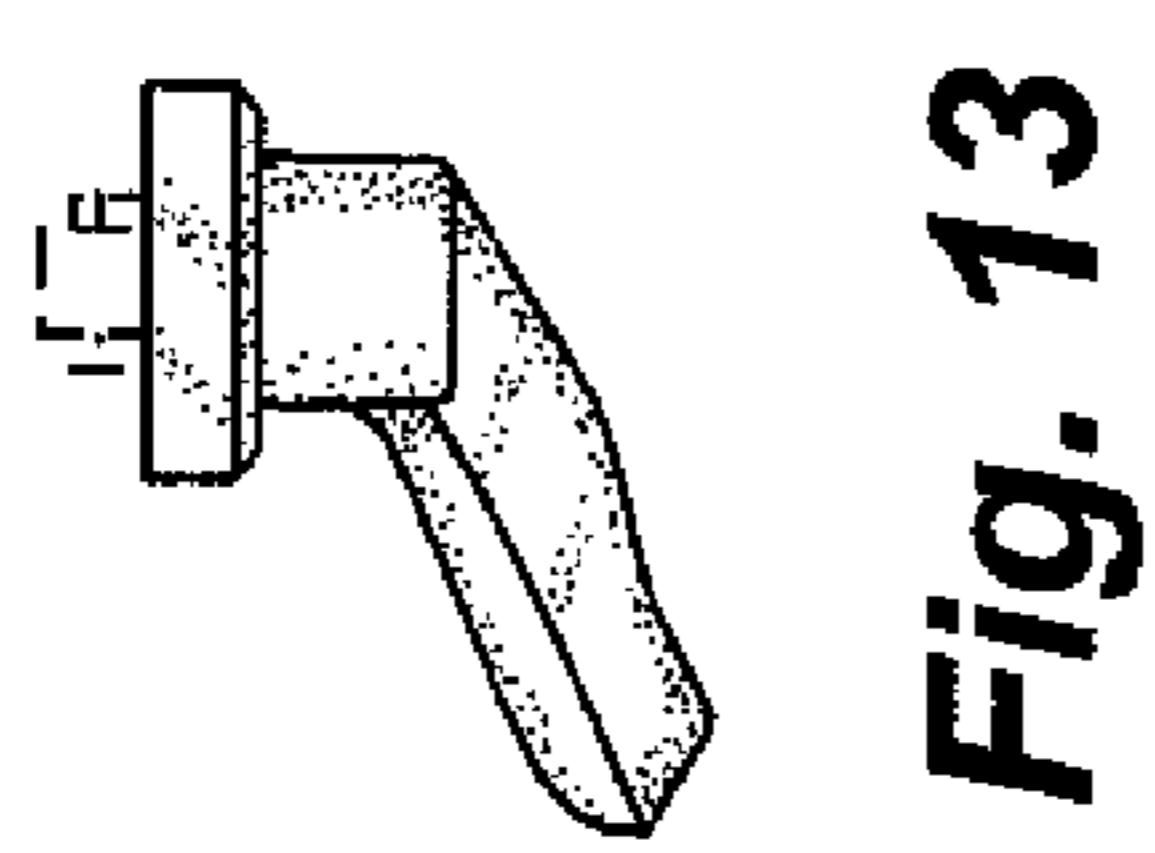
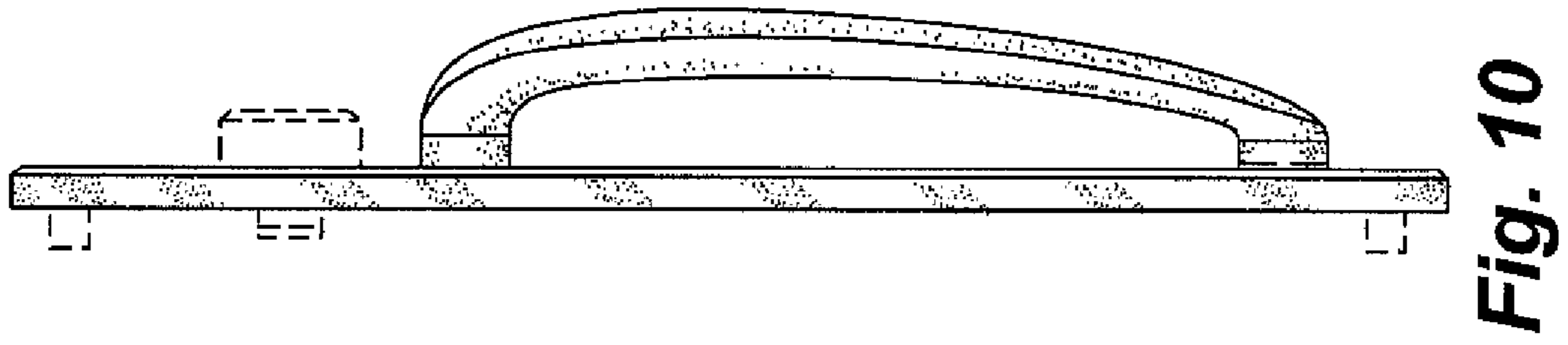
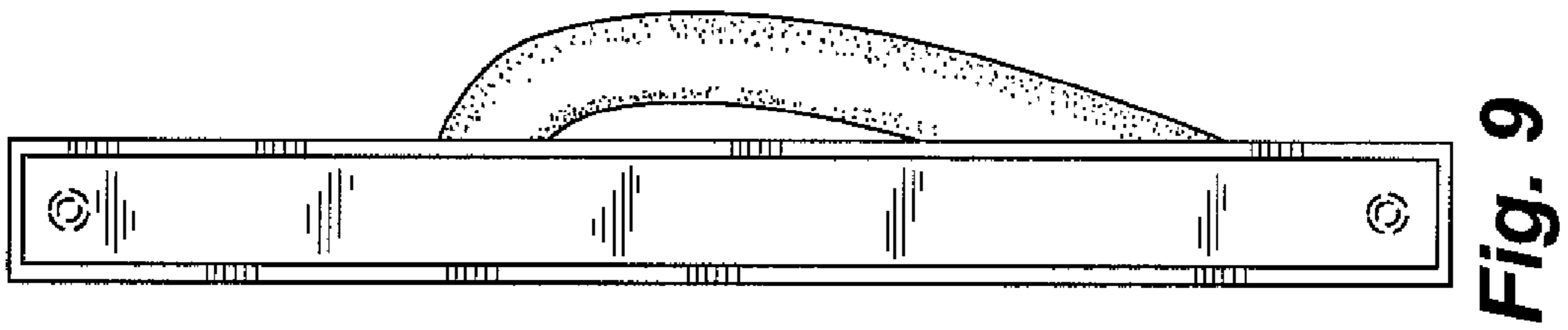
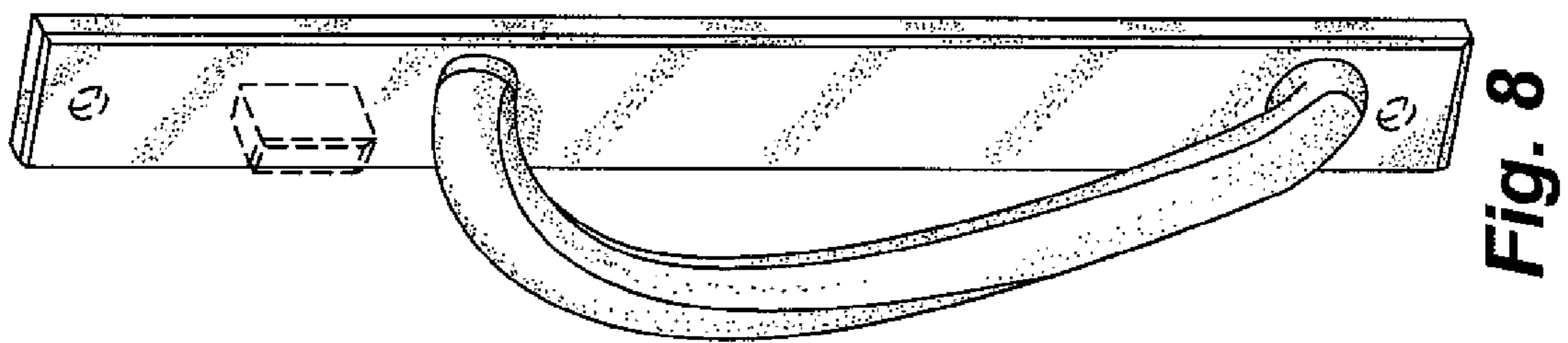



Fig. 15



Fig. 16



Fig. 17

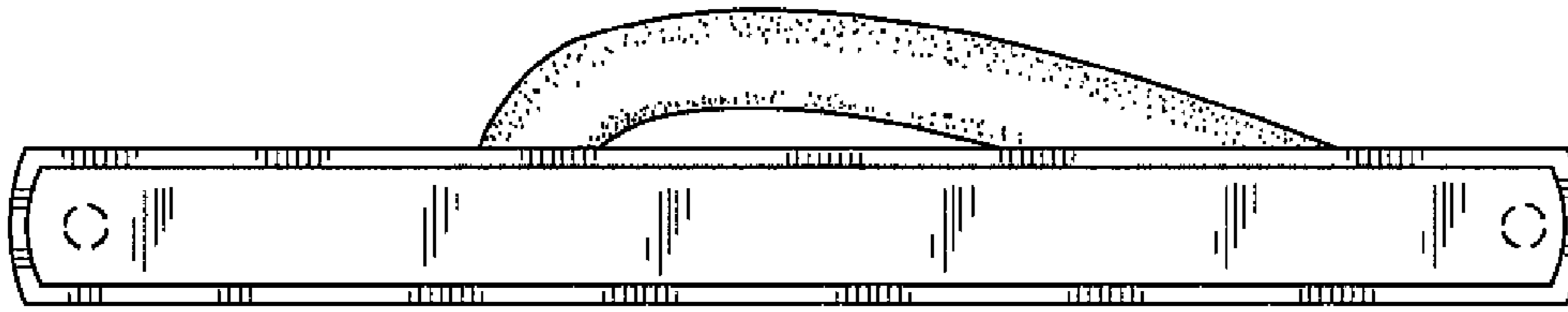

Fig. 18

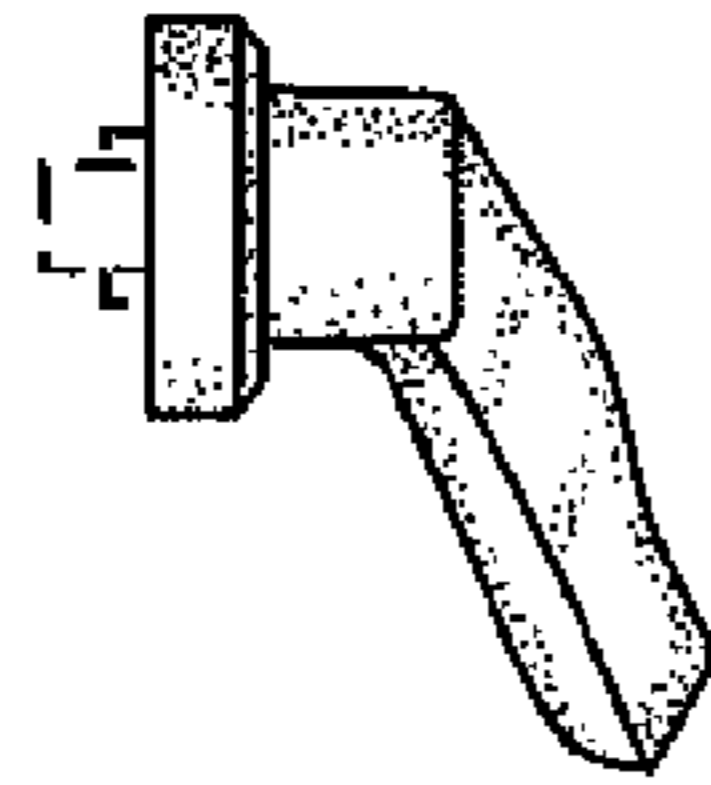

Fig. 19

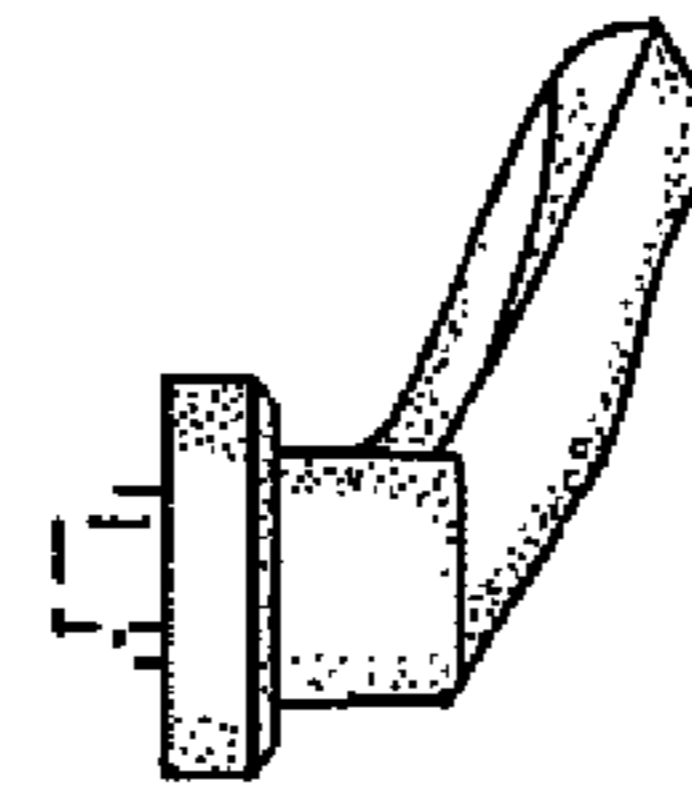

Fig. 20

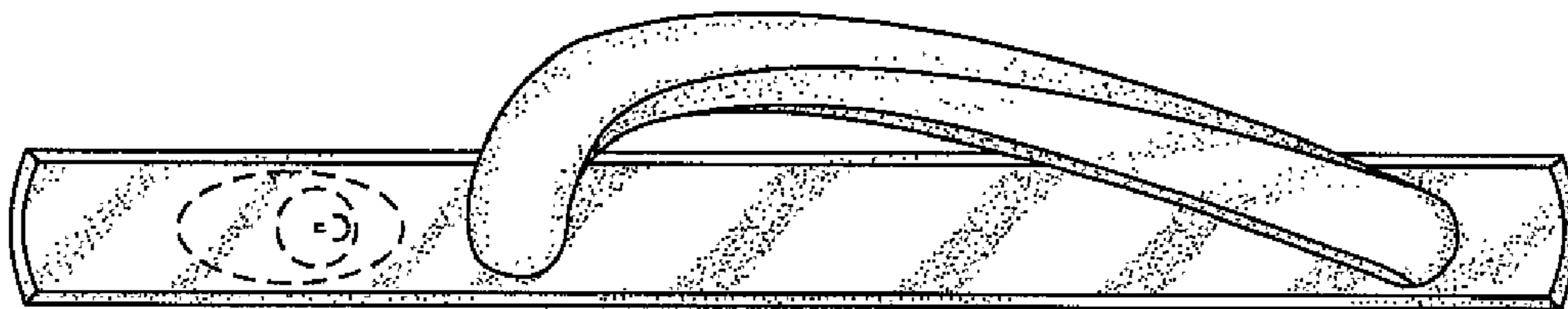

Fig. 21



Fig. 22

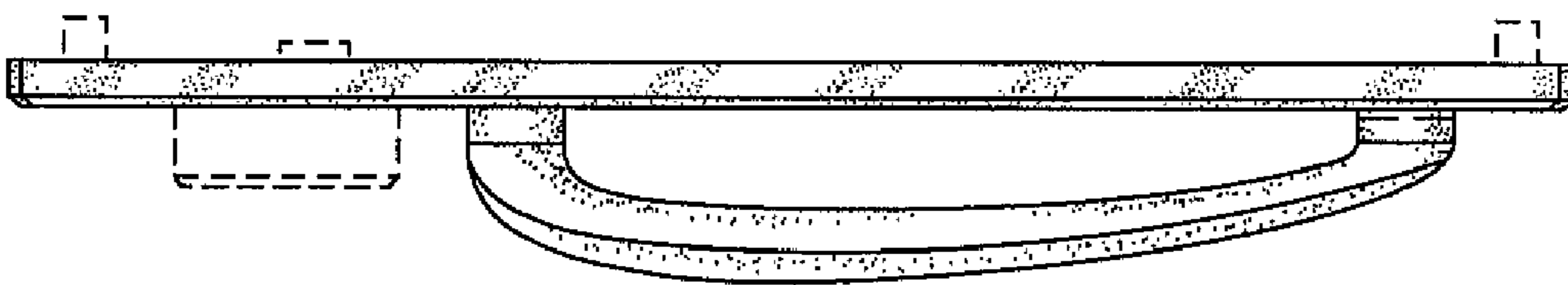

Fig. 23

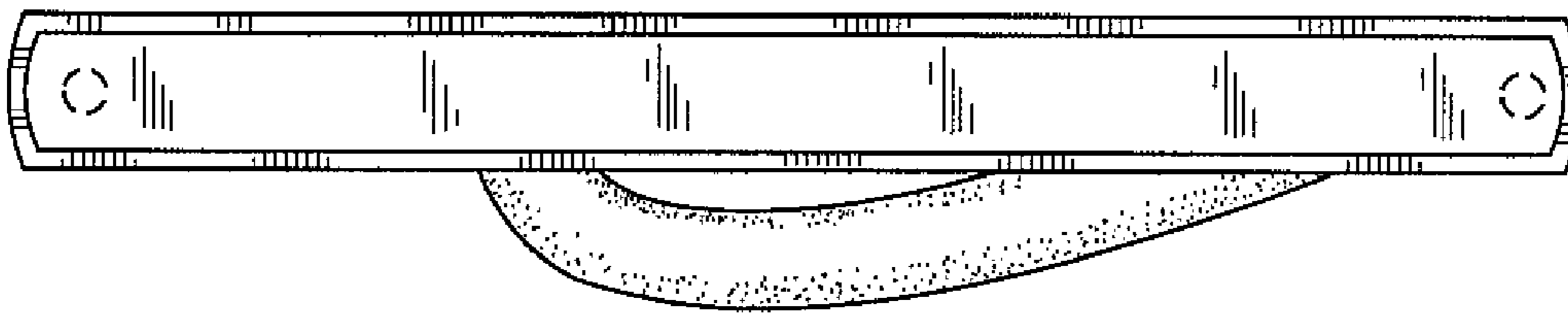

Fig. 24

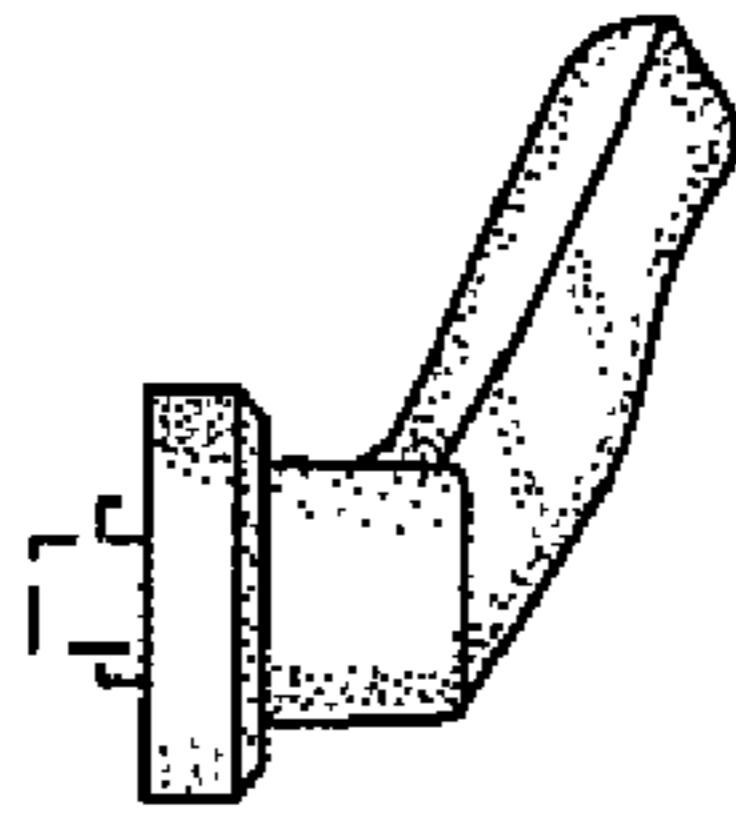

Fig. 25

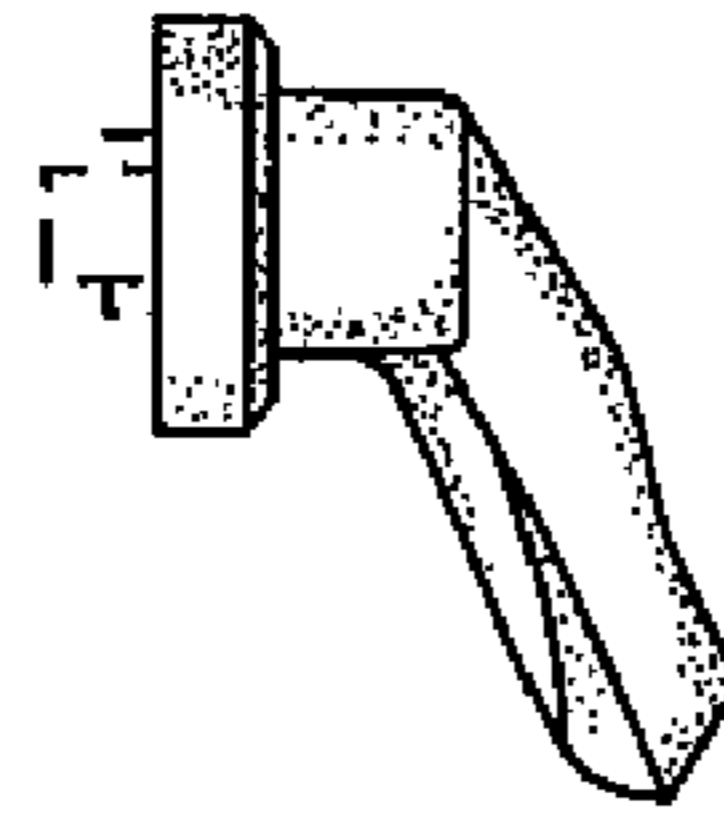

Fig. 26



Fig. 27

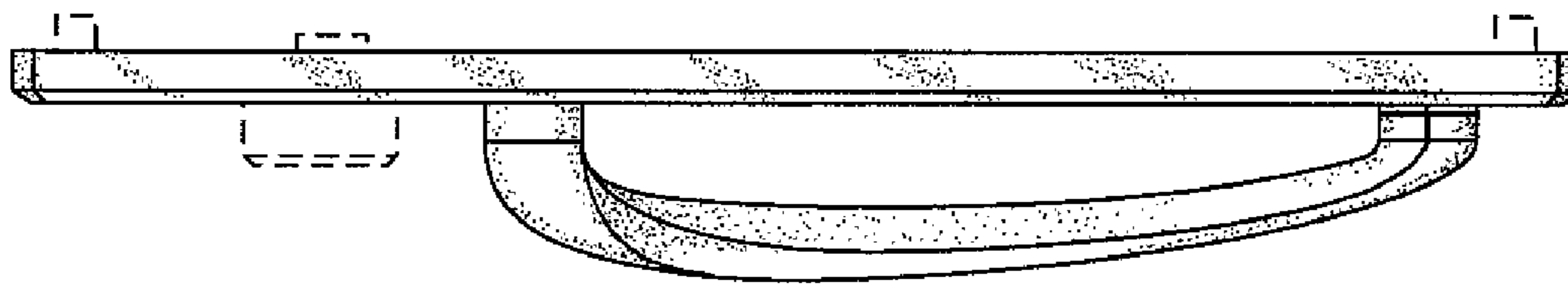

Fig. 28



Fig. 29

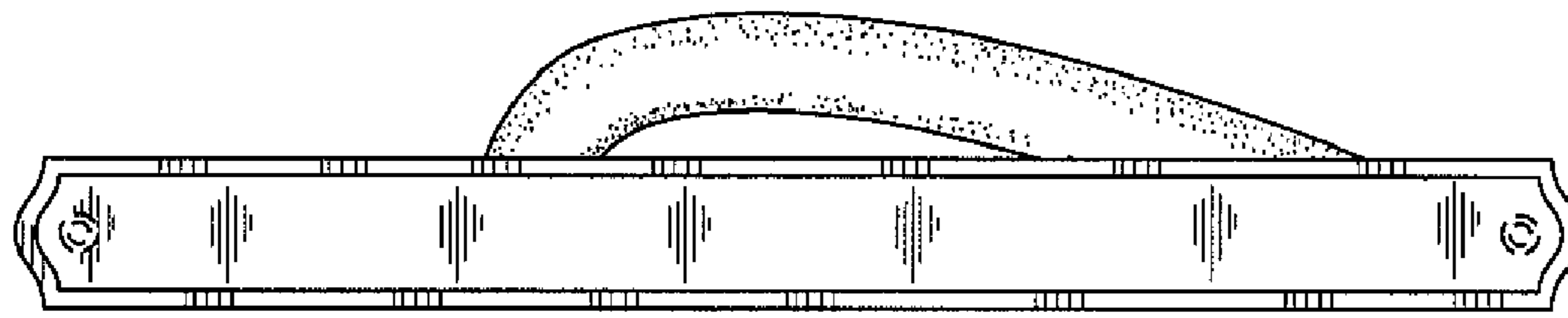

Fig. 30

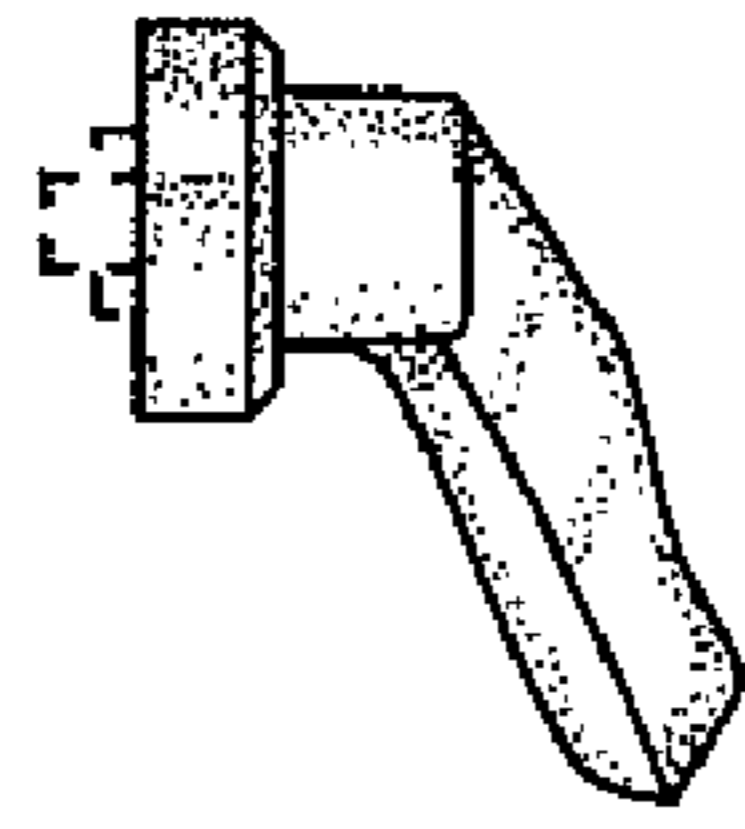

Fig. 31

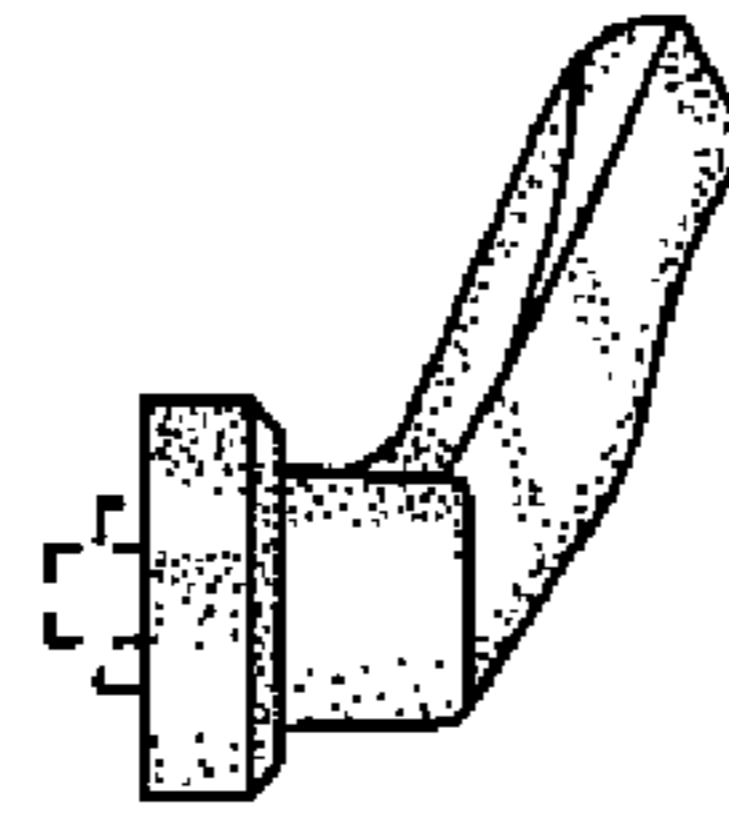

Fig. 32

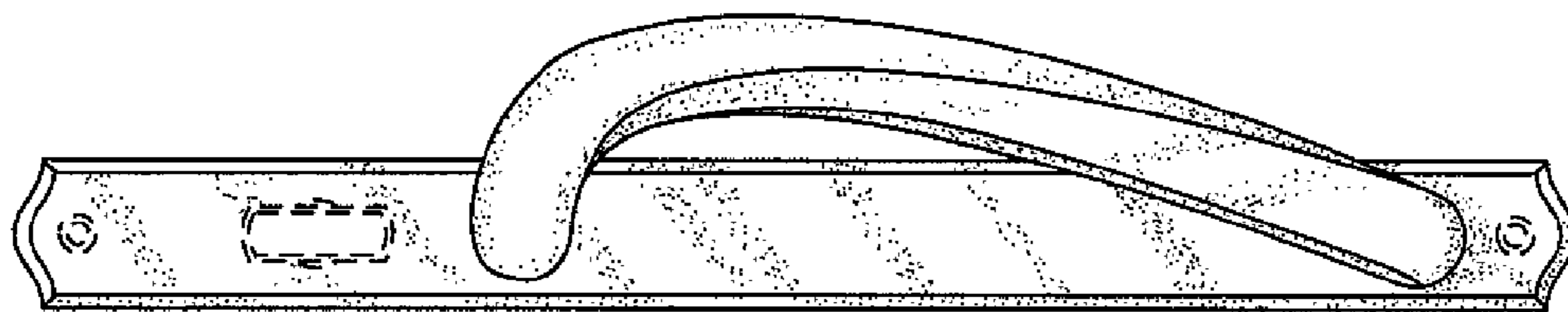

Fig. 33



Fig. 34

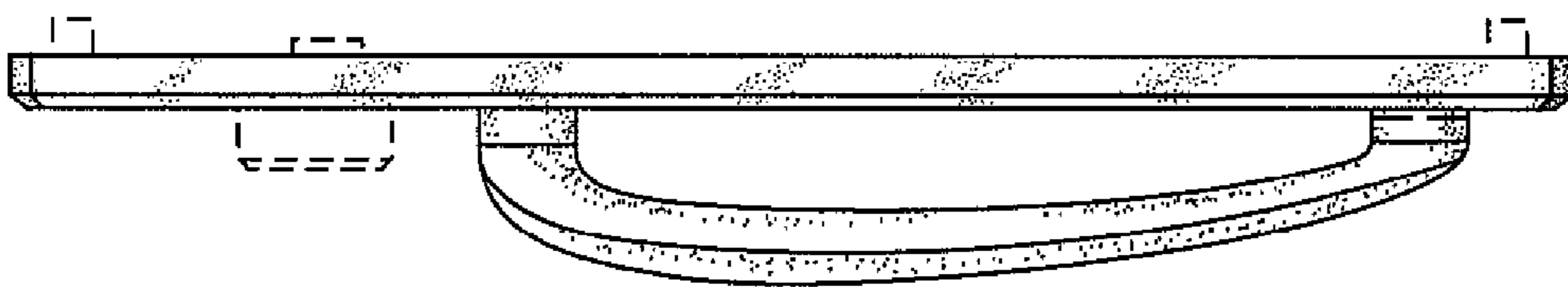

Fig. 35

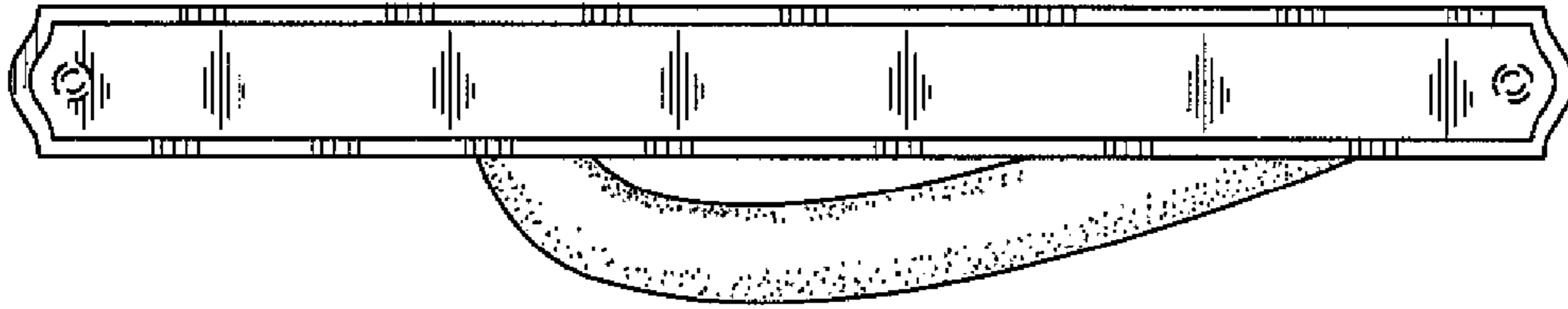

Fig. 36

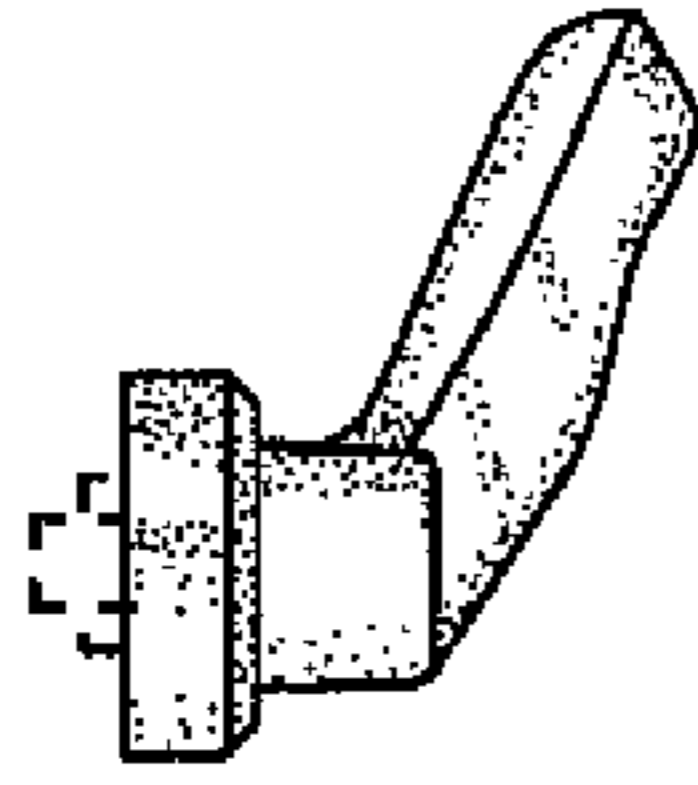

Fig. 37

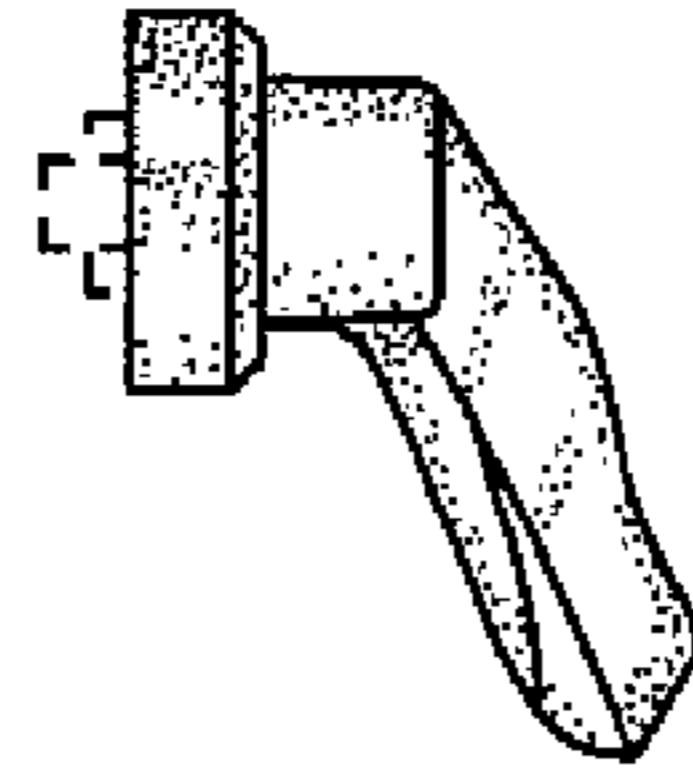

Fig. 38

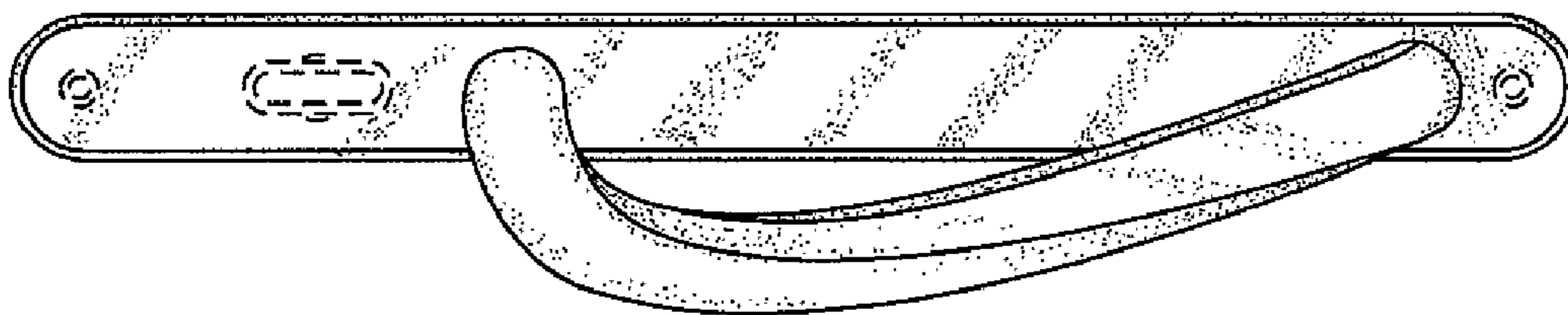

Fig. 39



Fig. 40



Fig. 41

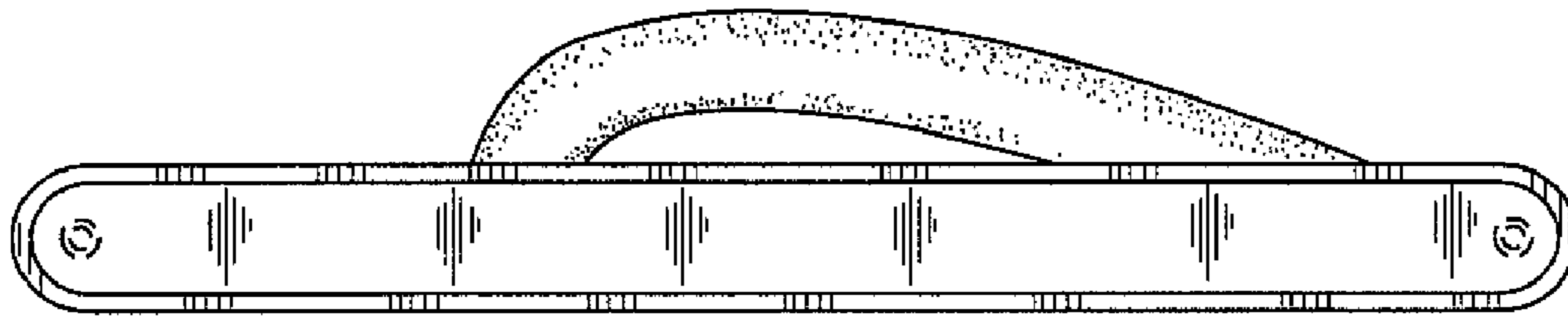

Fig. 42

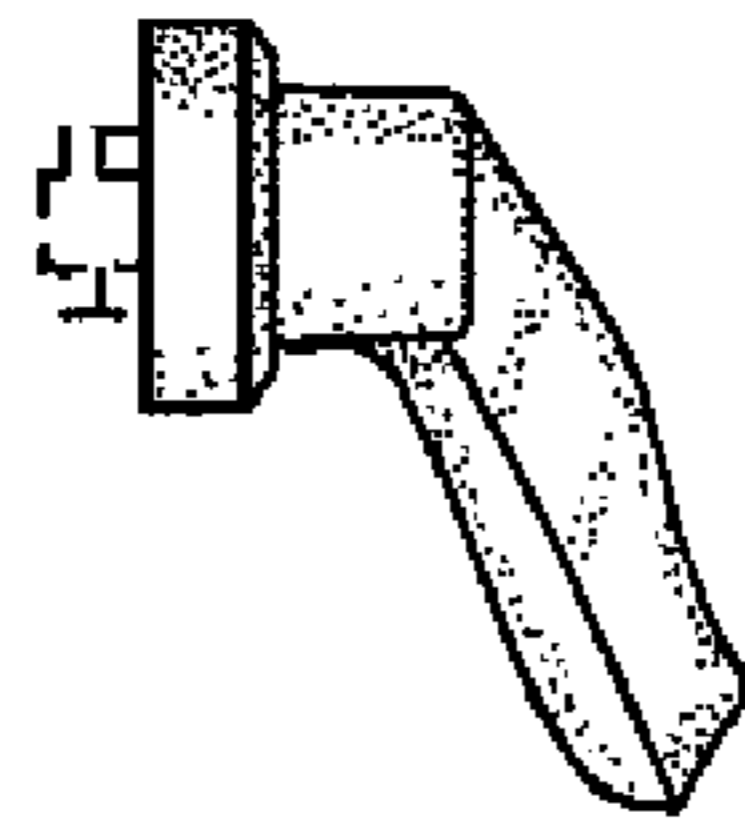

Fig. 43

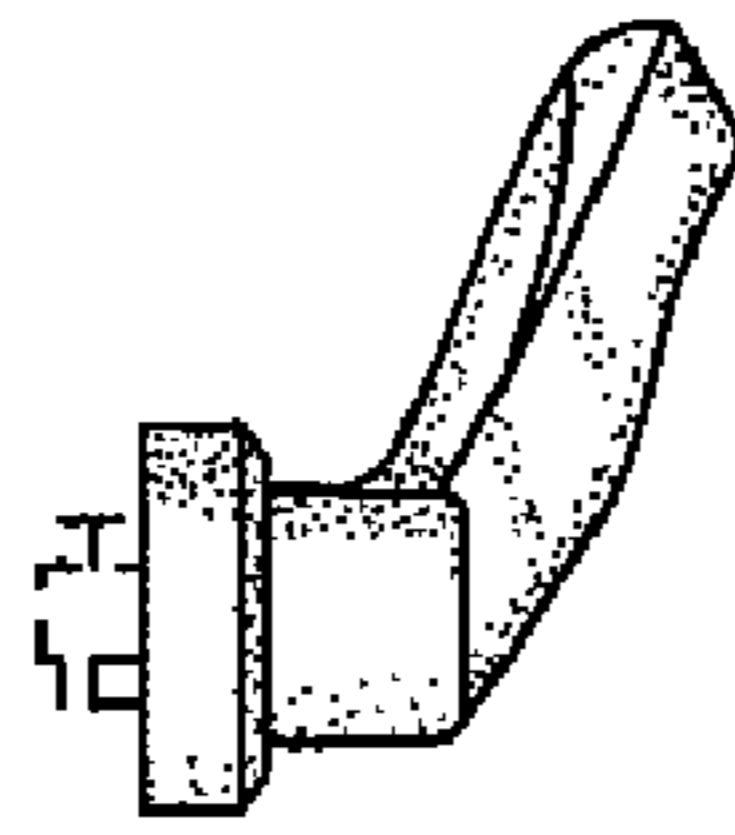

Fig. 44

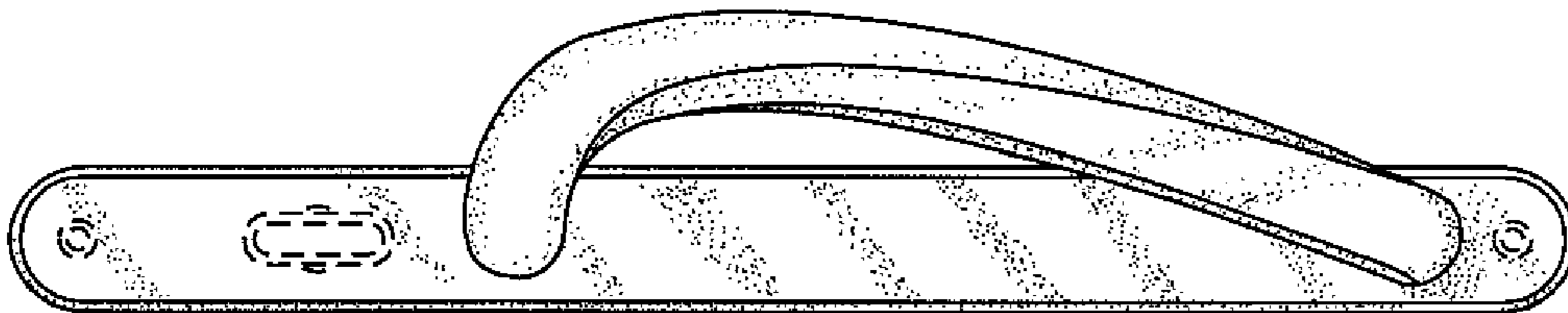

Fig. 45

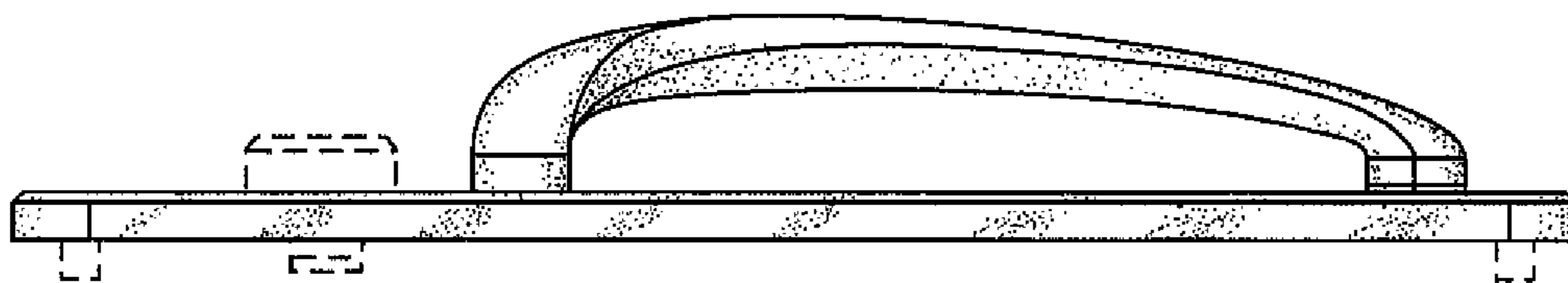

Fig. 46

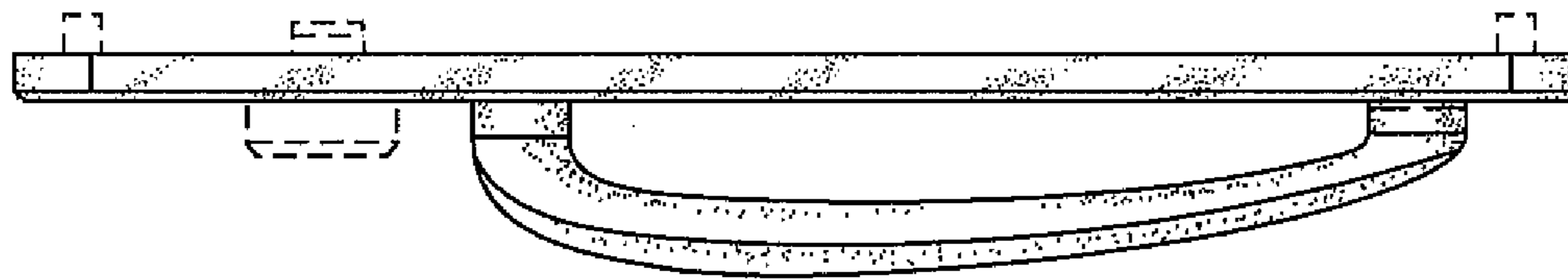

Fig. 47

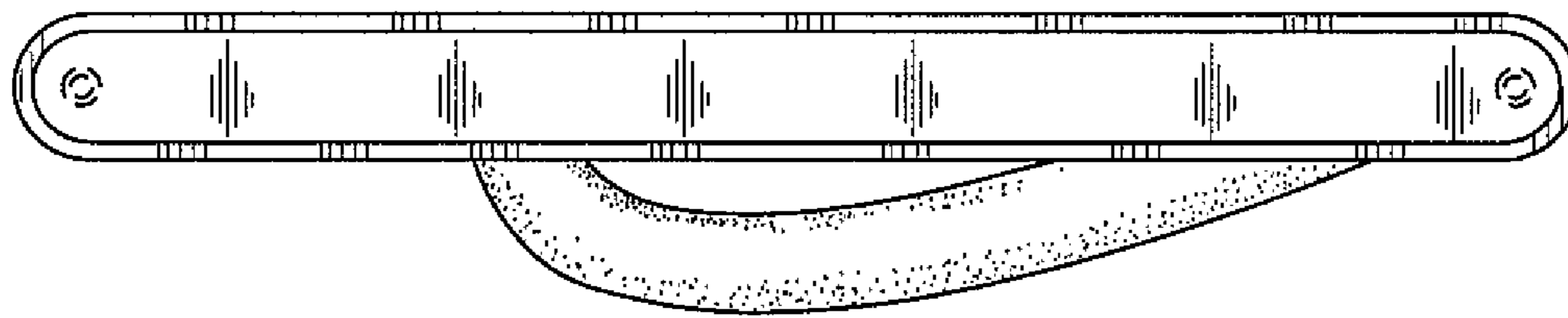

Fig. 48

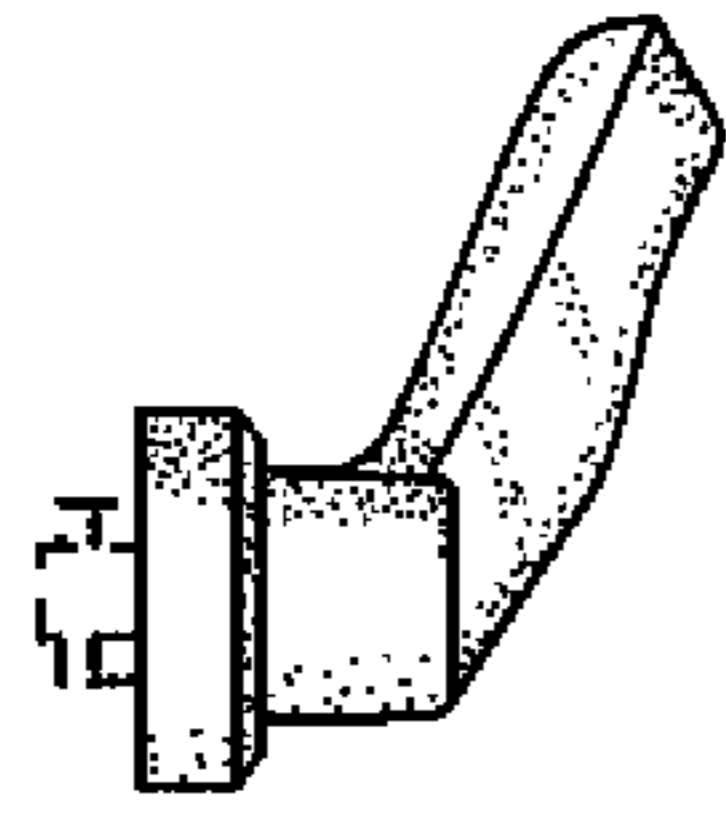

Fig. 49

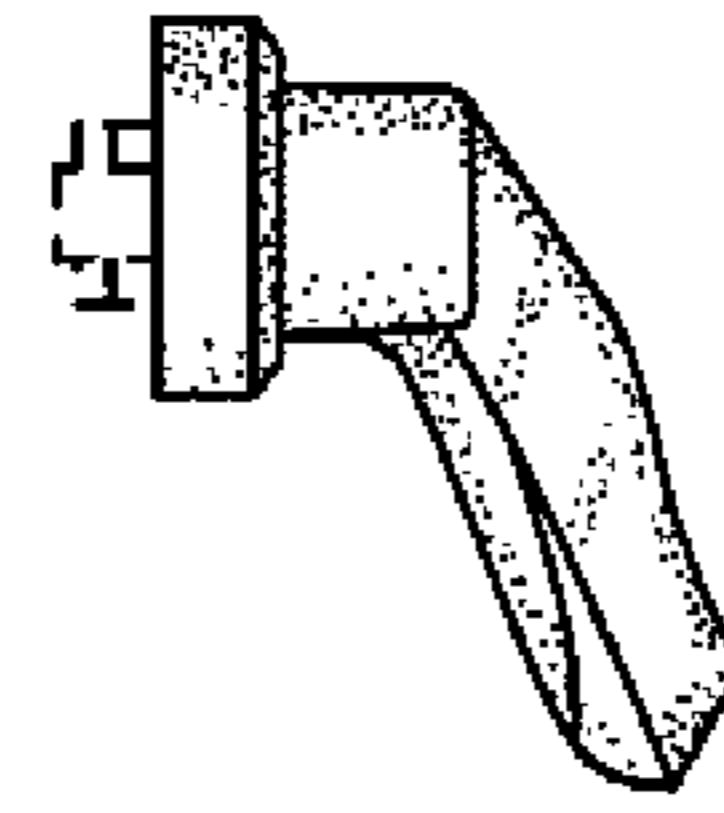

Fig. 50