



US00D592915S

(12) **United States Design Patent**  
**Olivari**

(10) **Patent No.:** **US D592,915 S**

(45) **Date of Patent:** **\*\* May 26, 2009**

(54) **SIFTER**

(75) Inventor: **Christian Olivari**, Orlando, FL (US)

(73) Assignee: **Dart Industries Inc.**, Orlando, FL (US)

(\*\*) Term: **14 Years**

(21) Appl. No.: **29/310,016**

(22) Filed: **Jul. 22, 2008**

(51) **LOC (9) Cl.** ..... **07-04**

(52) **U.S. Cl.** ..... **D7/667; D7/590**

(58) **Field of Classification Search** ..... D7/667,  
D7/590-598; 209/323, 347, 379, 381, 251,  
209/352, 355, 357, 282, 365.1, 374; D9/515,  
D9/544, 545, 546, 549

See application file for complete search history.

(56) **References Cited**

**U.S. PATENT DOCUMENTS**

D87,152 S	6/1932	Hall	
D101,879 S	11/1936	Leppke	
D154,955 S	8/1949	Robbens	
3,045,860 A	7/1962	Harvey	
D201,089 S *	5/1965	Swett	..... D7/668
3,415,376 A *	12/1968	Smith et al.	..... 209/357
D217,711 S	6/1970	Hazard	
D218,018 S	7/1970	Lattraye	
D247,611 S	3/1978	Giles	
D266,311 S	9/1982	Mattheis	
D266,819 S *	11/1982	Doyel	..... D7/668

D275,457 S	9/1984	Lilbit	
D290,921 S *	7/1987	Dardashti	..... D7/668
D318,986 S	8/1991	DeCoster et al.	
D326,813 S	6/1992	Gavala, Jr. et al.	
D327,012 S	6/1992	Gavala, Jr. et al.	
D390,069 S	2/1998	DeCoster	
D398,234 S	9/1998	Cautereels	
5,850,923 A	12/1998	DeCoster et al.	
D498,988 S	11/2004	Thornton	
D503,341 S	3/2005	DelMotte	

\* cited by examiner

*Primary Examiner*—Terry A Wallace

(74) *Attorney, Agent, or Firm*—John A. Doninger

(57) **CLAIM**

The ornamental design for a sifter, as shown and described.

**DESCRIPTION**

FIG. 1 is a top, side and front perspective view of a sifter showing my new design;

FIG. 2 is a front elevation view thereof;

FIG. 3 is a rear elevation view thereof;

FIG. 4 is a right side elevation view thereof;

FIG. 5 is a left side elevation view thereof;

FIG. 6 is a top plan view thereof;

FIG. 7 is a bottom plan view thereof; and,

FIG. 8 is a bottom, side and rear perspective view thereof.

**1 Claim, 8 Drawing Sheets**

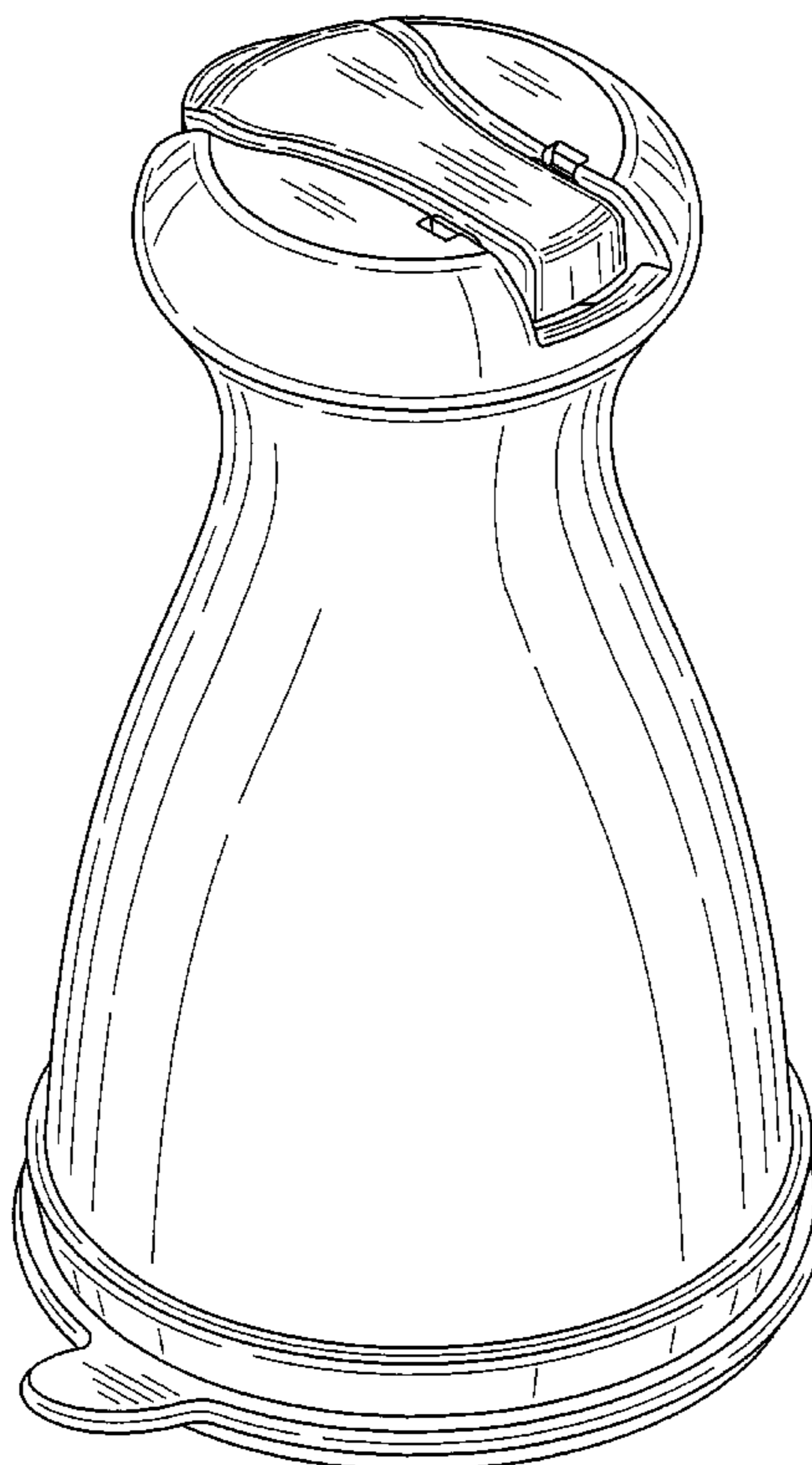

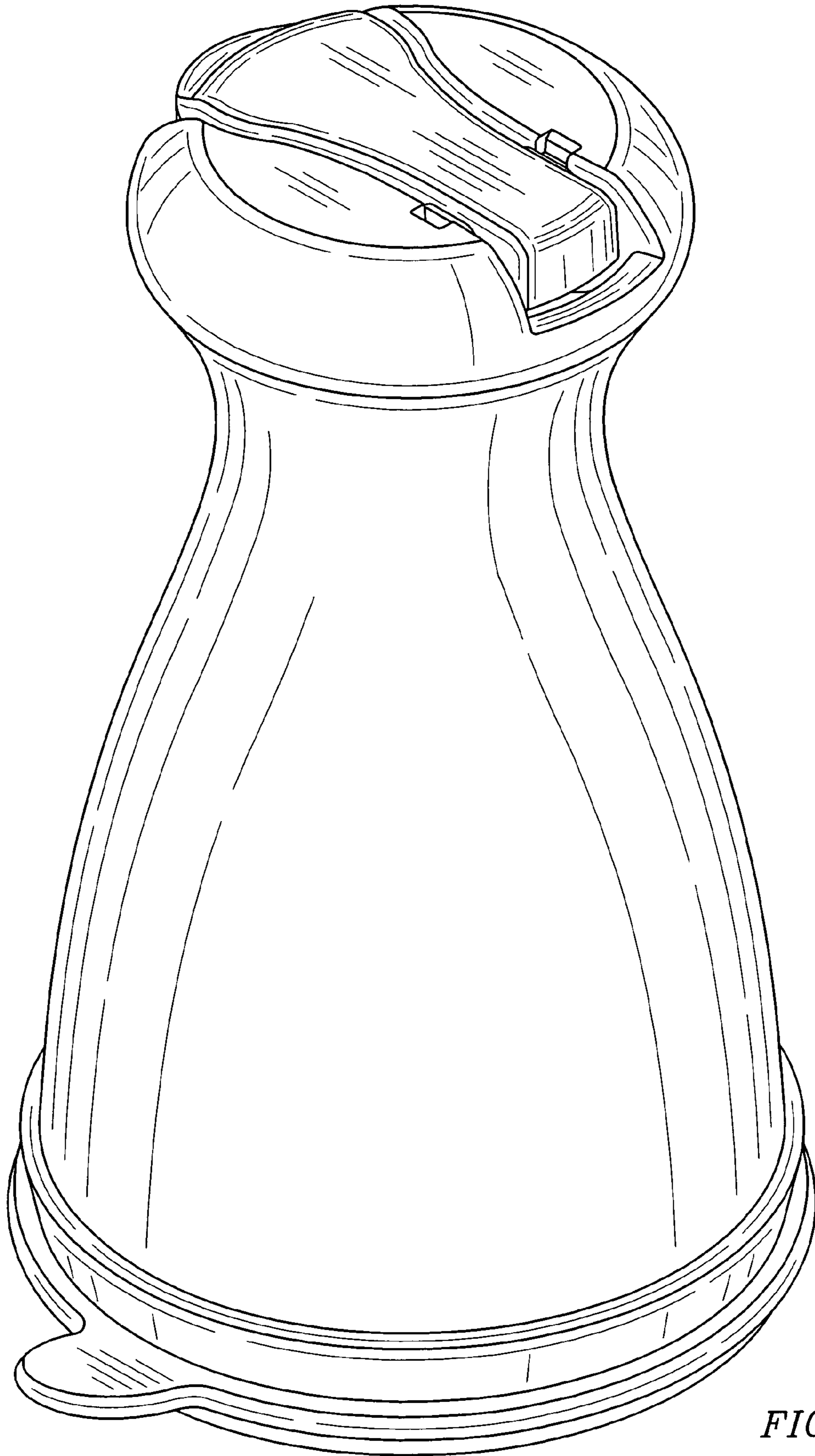

FIG. 1

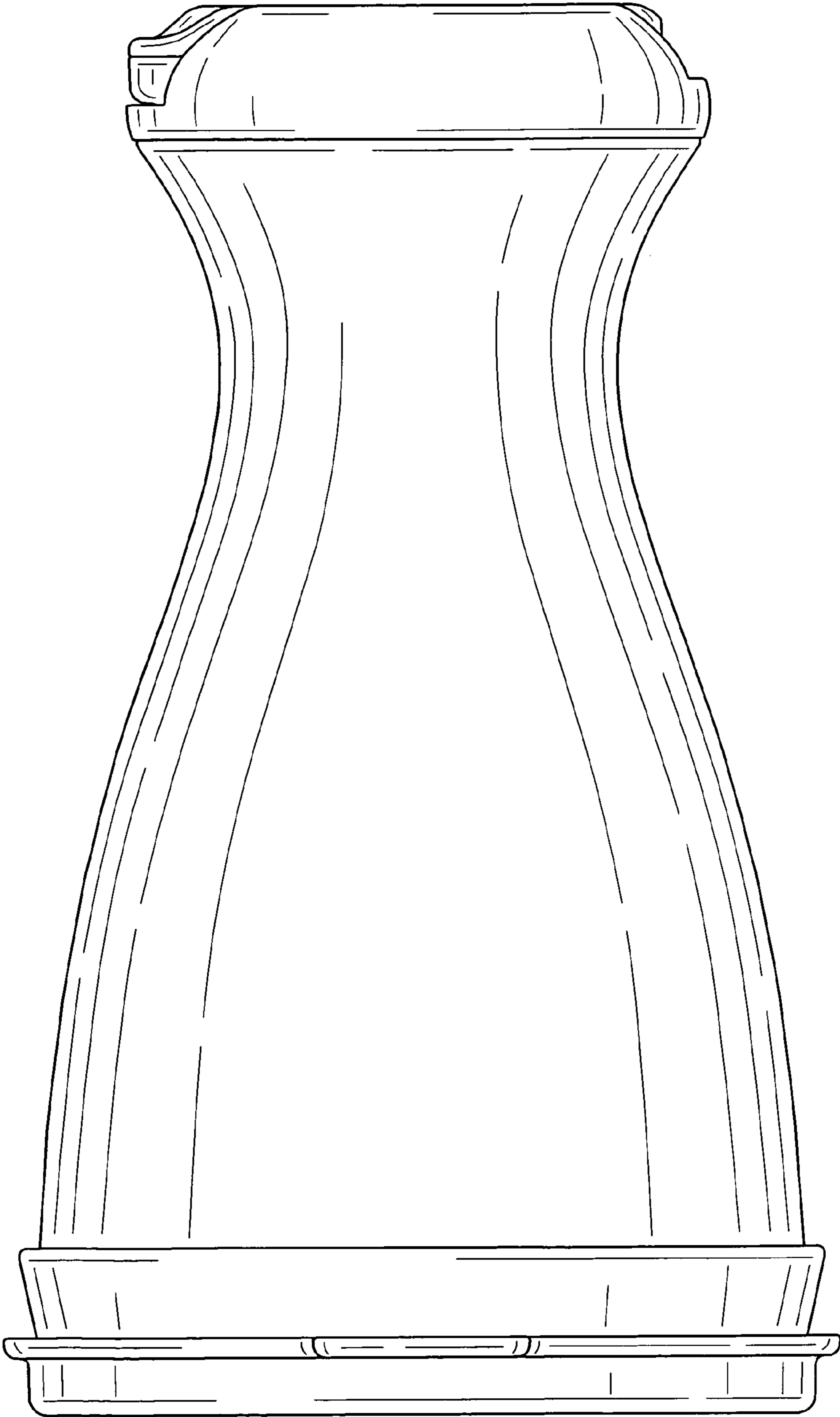

FIG. 2

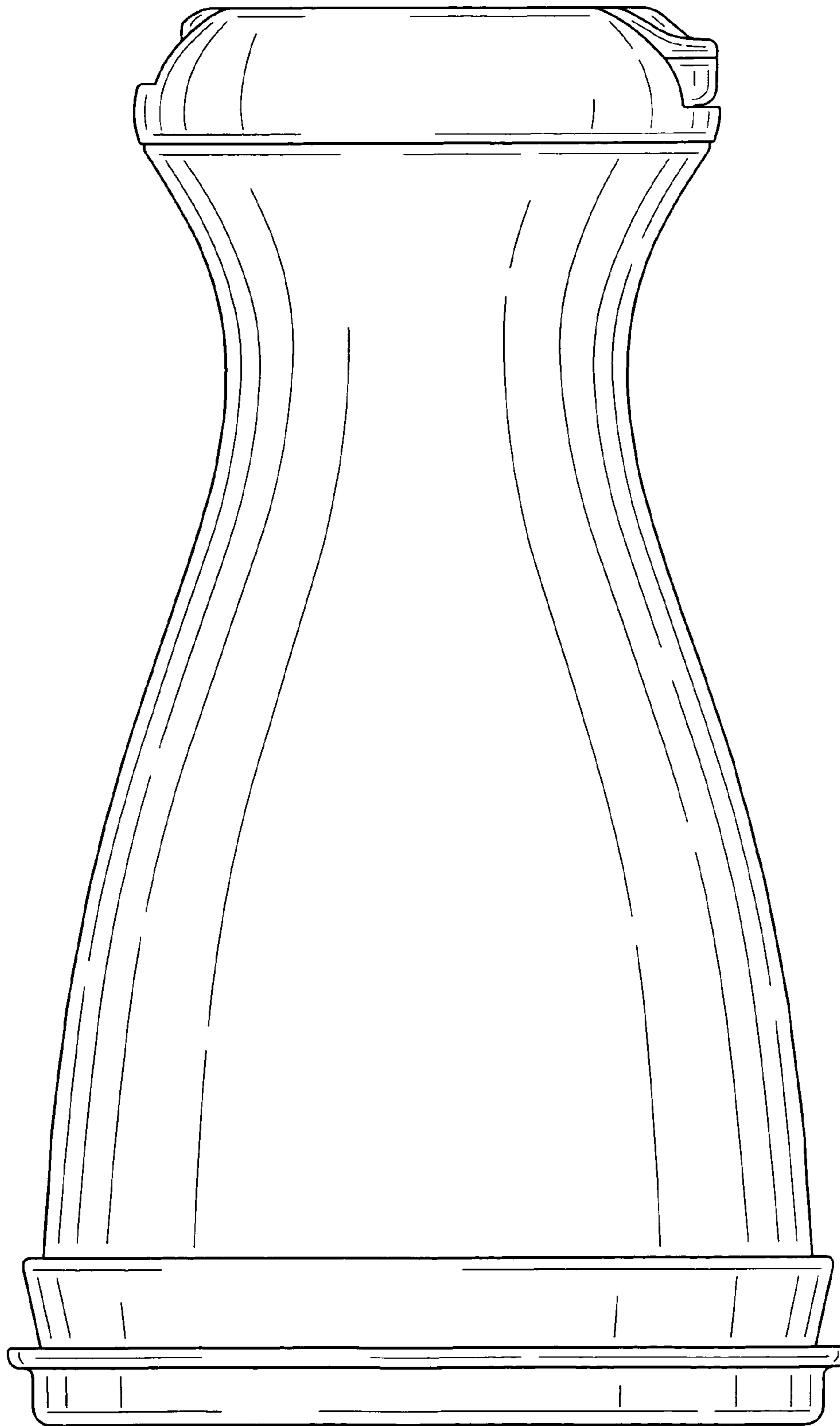

FIG. 3

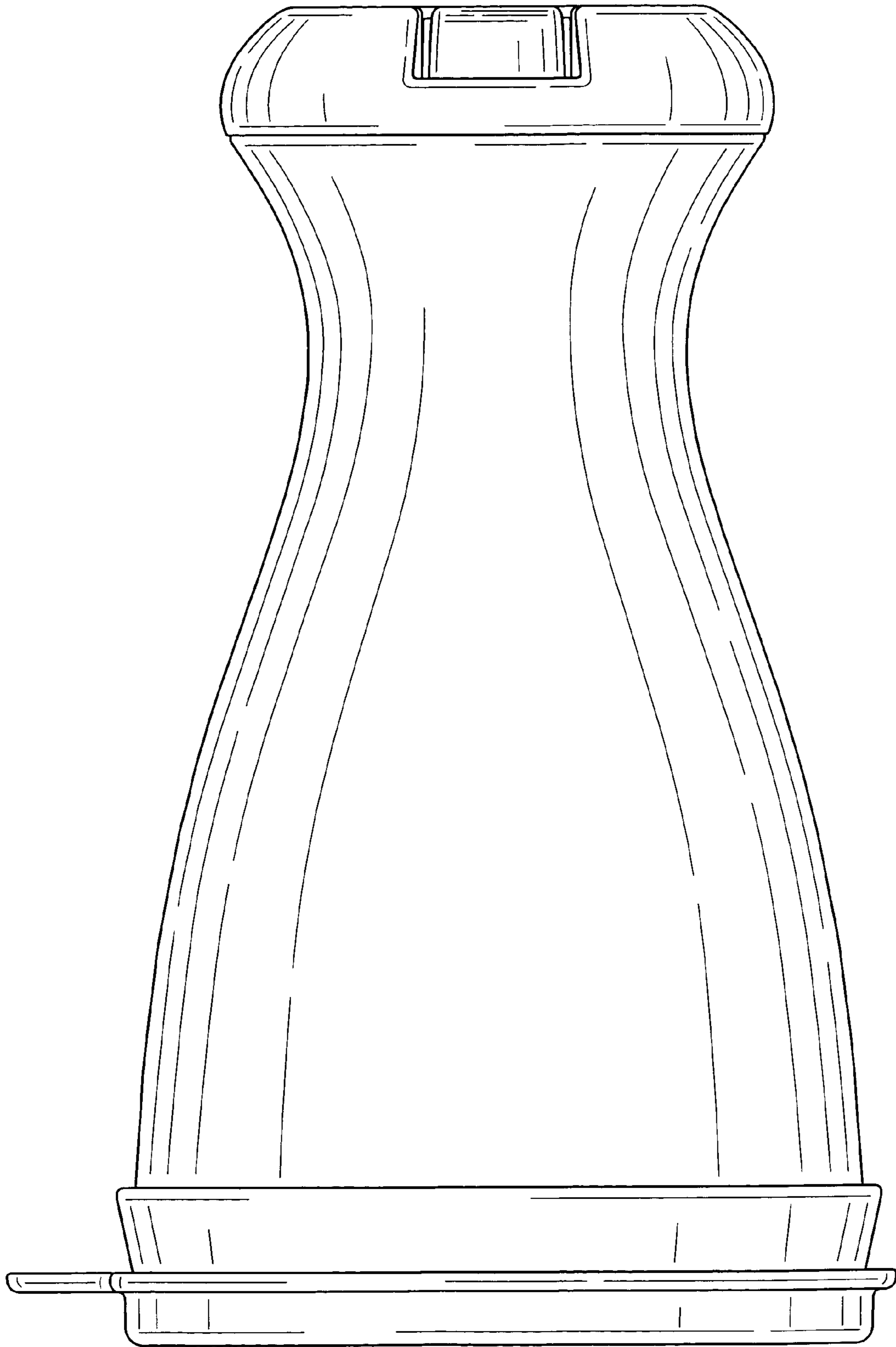

FIG. 4

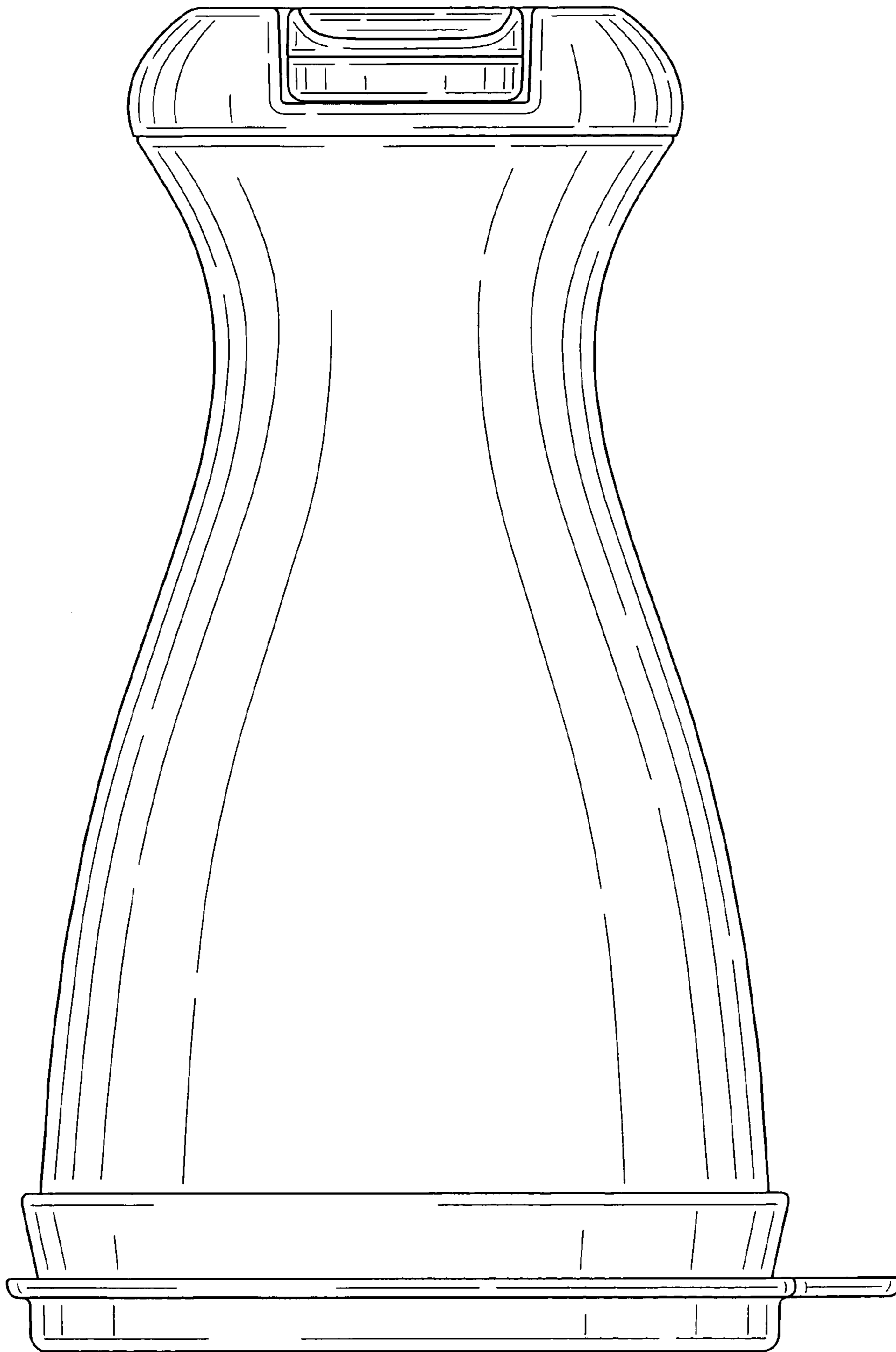

FIG. 5

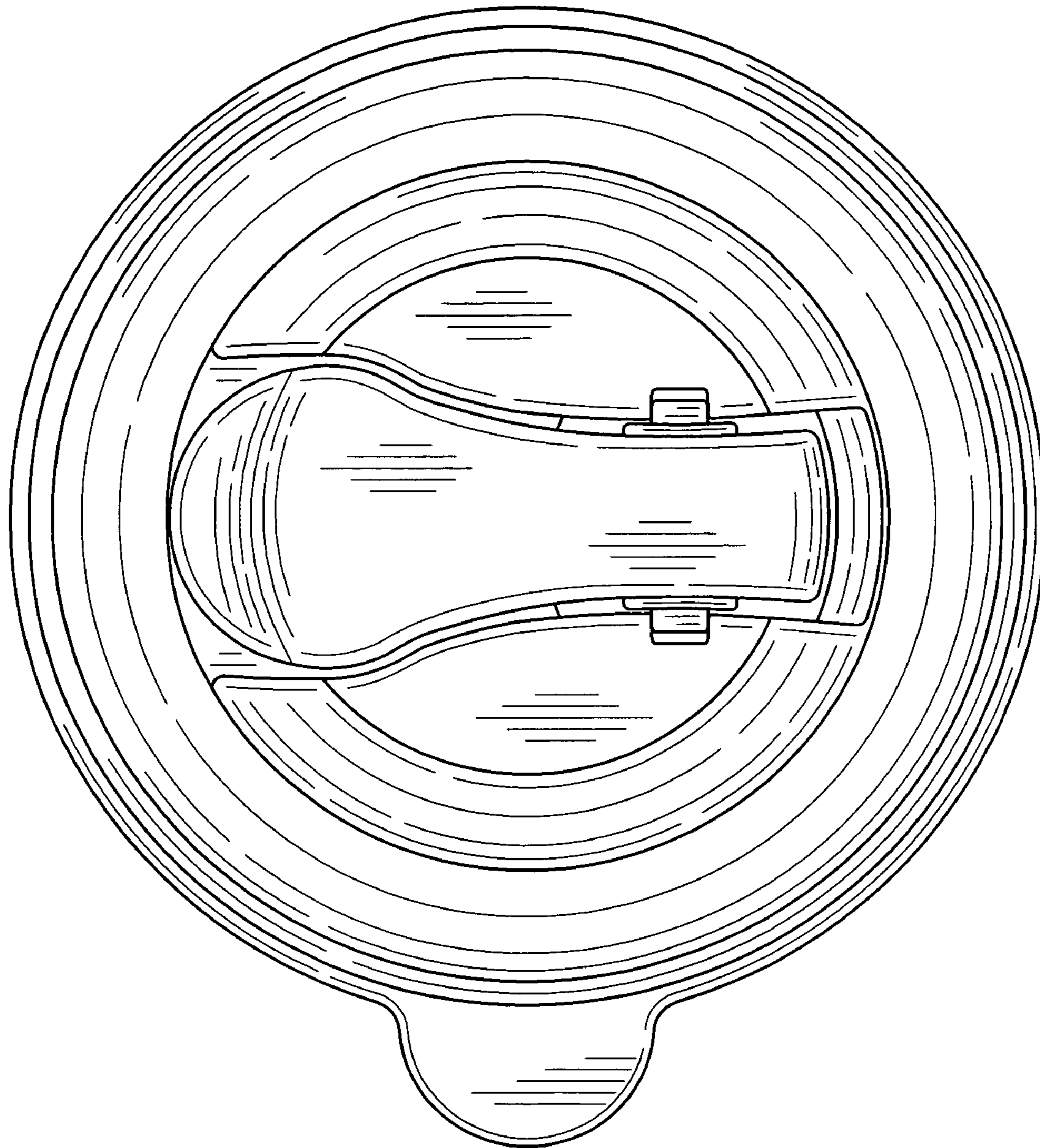
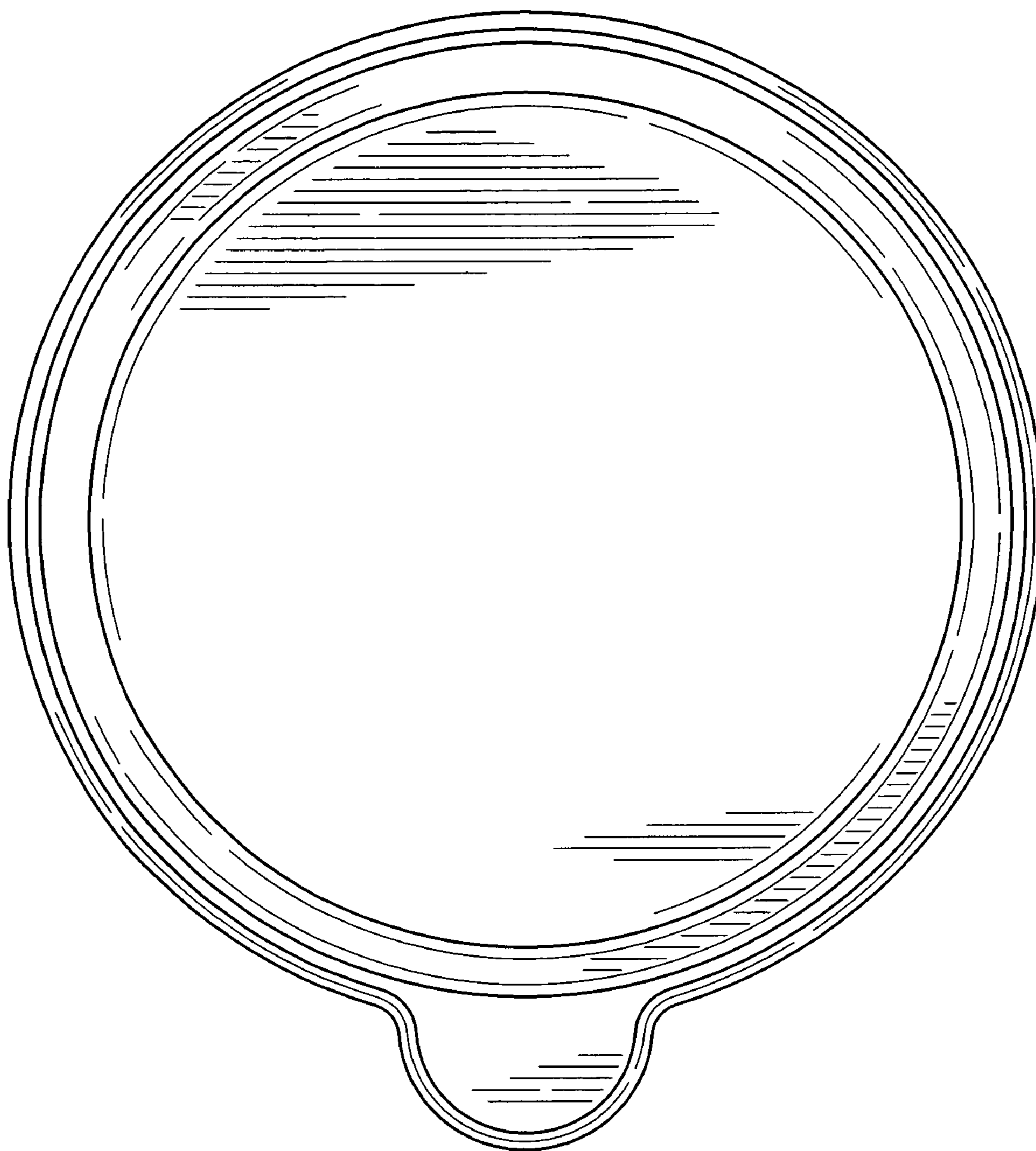

FIG. 6



*FIG. 7*



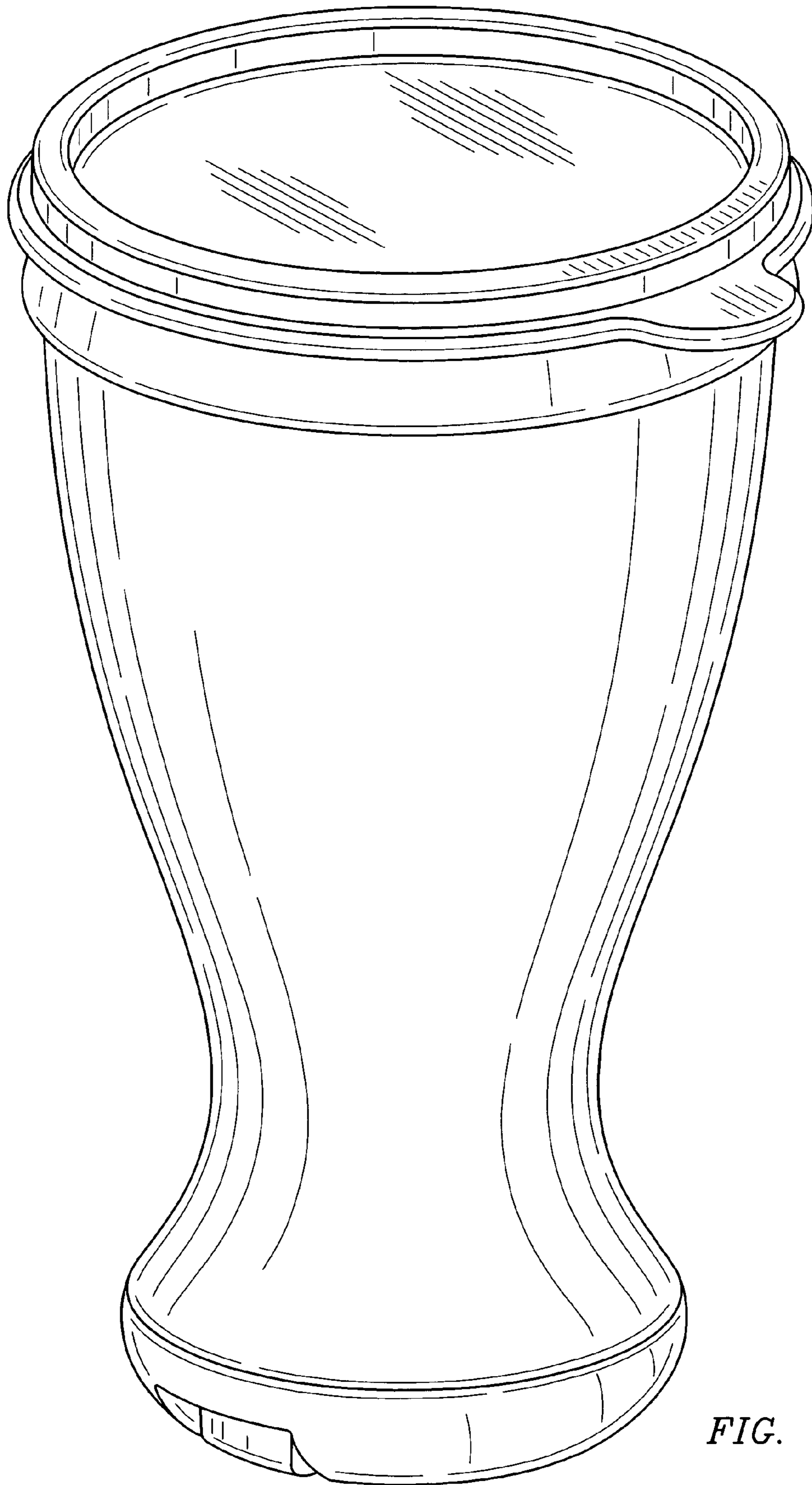

FIG. 8