



US00D592852S

(12) **United States Design Patent**
Mermea

(10) **Patent No.:** **US D592,852 S**

(45) **Date of Patent:** **** May 26, 2009**

(54) **FLUORESCENT TUBE PROTECTIVE CASE**

(57) **CLAIM**

(76) **Inventor:** **Ernest Montoya Mermea**, 9214
Blockade Dr., San Antonio, TX (US)
78240

I claim the ornamental design for a fluorescent tube protective case, as shown and described.

(**) **Term:** **14 Years**

DESCRIPTION

(21) **Appl. No.:** **29/332,410**

(22) **Filed:** **Feb. 14, 2009**

(51) **LOC (9) Cl.** **03-01**

(52) **U.S. Cl.** **D3/269**

(58) **Field of Classification Search** D3/254,
D3/260, 262, 273, 276, 291, 221; 206/315.1,
206/443; 190/100, 110, 111, 119, 120, 121;
473/1, 2, 3

See application file for complete search history.

(56) **References Cited**

U.S. PATENT DOCUMENTS

D293,044	S	*	12/1987	Johnson	D3/300
5,553,708	A	*	9/1996	Lawrence et al.	206/419
D392,801	S	*	3/1998	Hields et al.	D3/261
5,829,591	A	*	11/1998	Lyons	206/373
D437,680	S	*	2/2001	Gobel	D3/11
D442,367	S	*	5/2001	Terrell	D3/260
D479,398	S	*	9/2003	Sanderson	D3/254
D505,260	S	*	5/2005	Gruetzmacher	D3/269

* cited by examiner

Primary Examiner—Raphael Barkai

Assistant Examiner—Randall H Gholson

(74) *Attorney, Agent, or Firm*—QuickPatents, Inc.; Kevin Prince

FIG. 1 is an exploded perspective view of a fluorescent tube protective case, illustrating a two-tube embodiment, showing my new design;

FIG. 2 is a front elevational view of the invention;

FIG. 3 is a rear elevational view of the invention;

FIG. 4 is a left-side elevational view of the invention, illustrating the two-tube embodiment, the right-side elevational view being a mirror image thereof;

FIG. 5 is a top plan view of the invention;

FIG. 6 is a bottom plan view of the invention;

FIG. 7 is an exploded perspective view of the invention, illustrating a four-tube embodiment;

FIG. 8 is a left-side elevational view of the invention, illustrating the four-tube embodiment, the right-side elevational view being a mirror image thereof;

FIG. 9 is a top plan view of the invention, illustrating the four-tube embodiment; and,

FIG. 10 is a bottom plan view of the invention, illustrating the four-tube embodiment.

The broken lines showing fluorescent lighting tubes in FIGS. 1 and 7 are included for the purpose of illustrating the invention in use, and form no part of the claimed design.

1 Claim, 3 Drawing Sheets

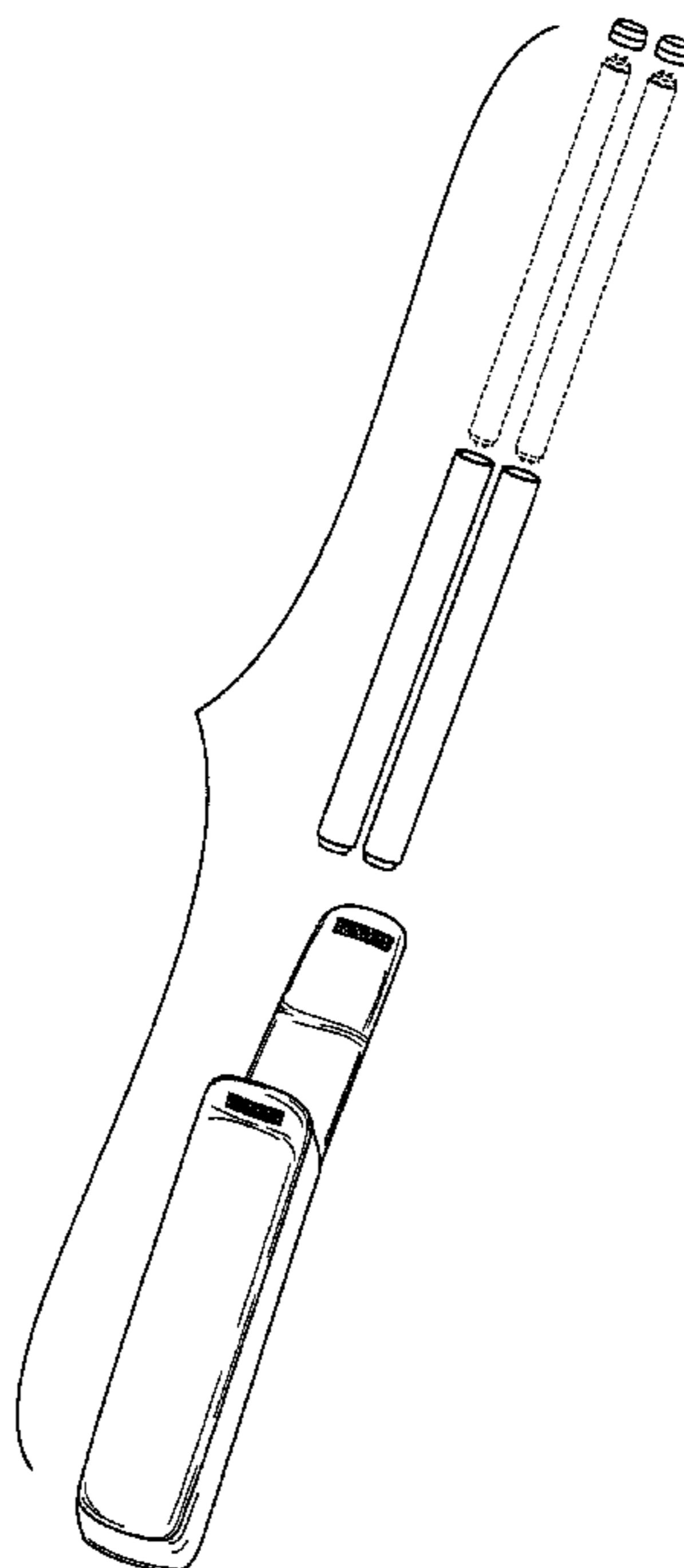

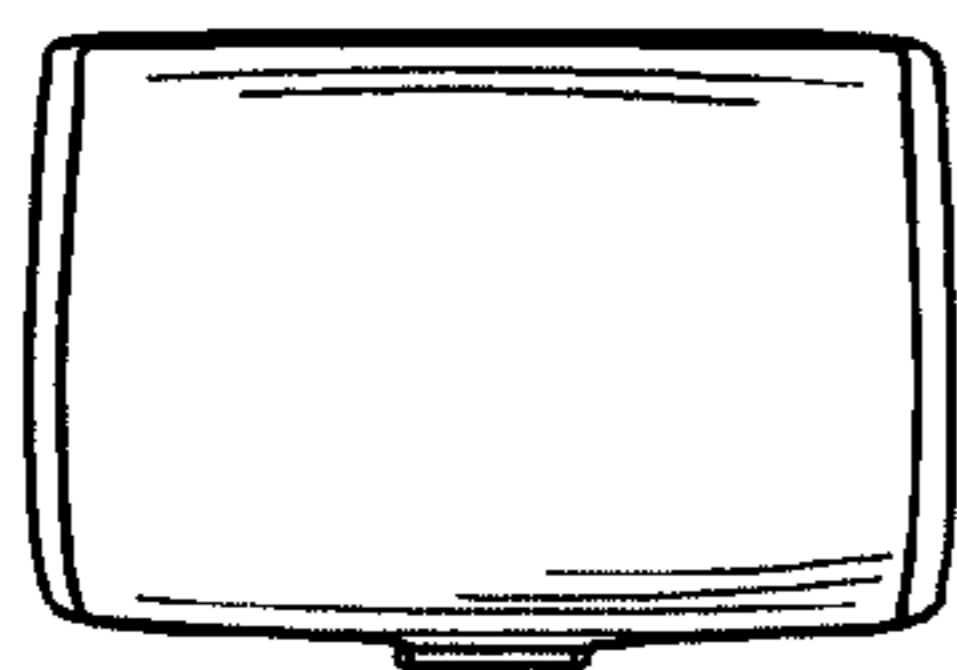

FIG. 5

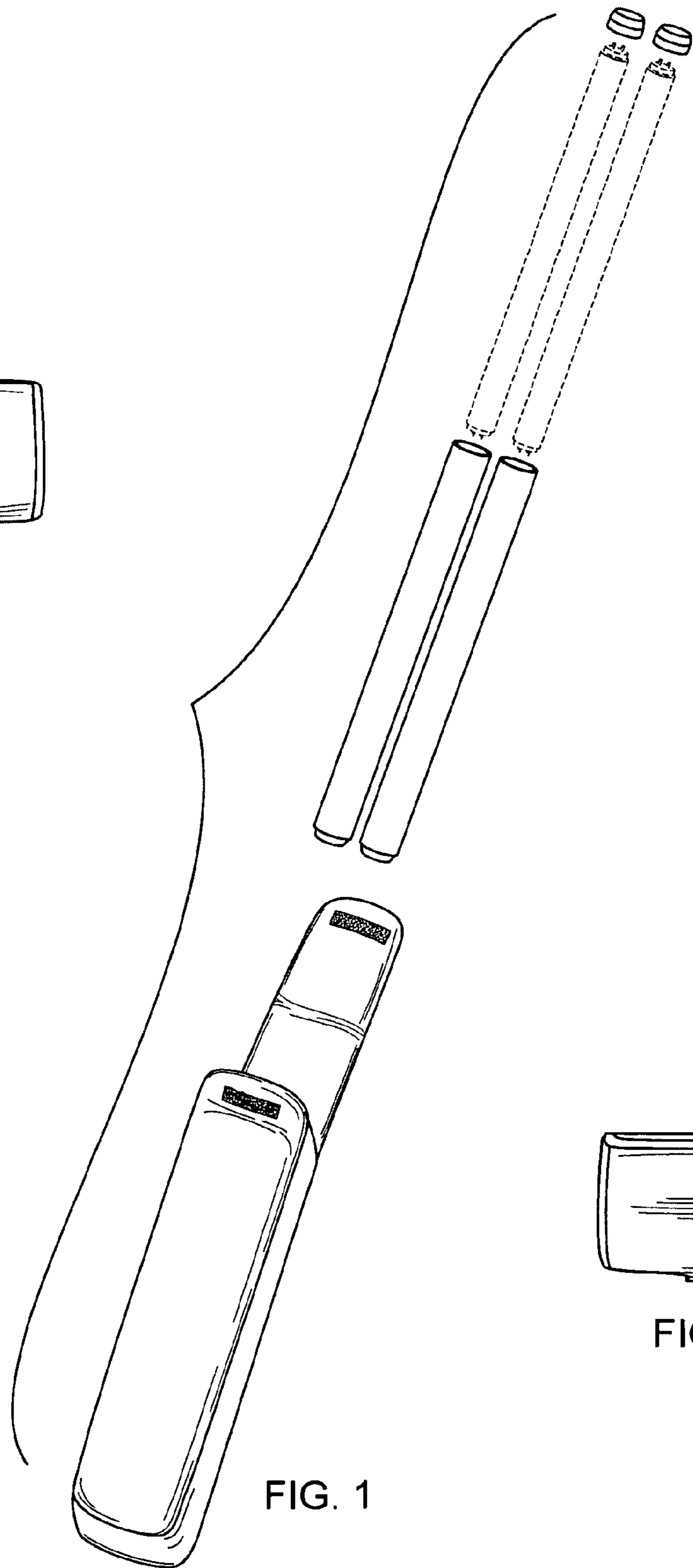

FIG. 1



FIG. 6

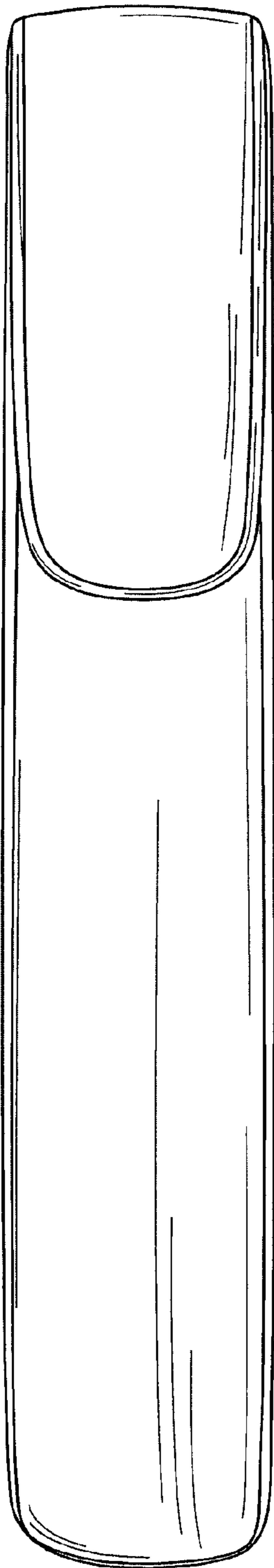

FIG. 2

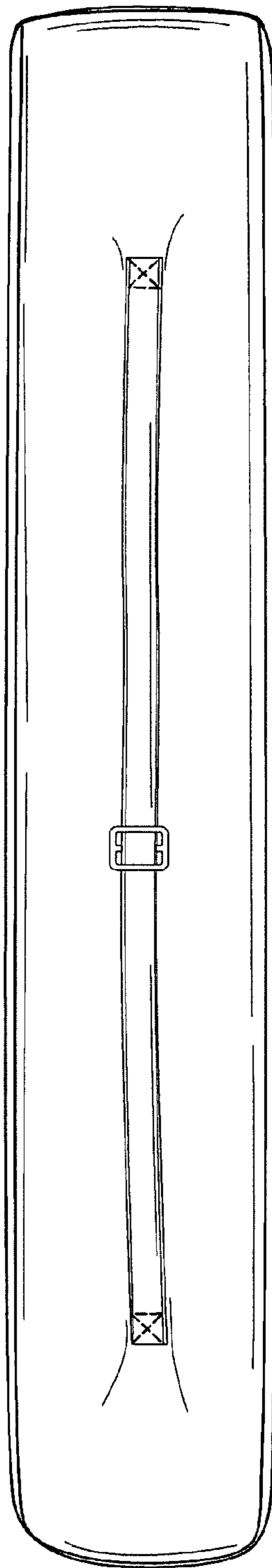

FIG. 3

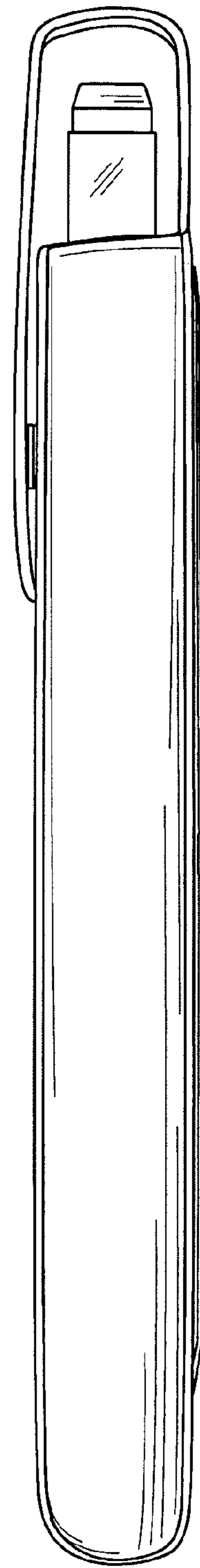

FIG. 4

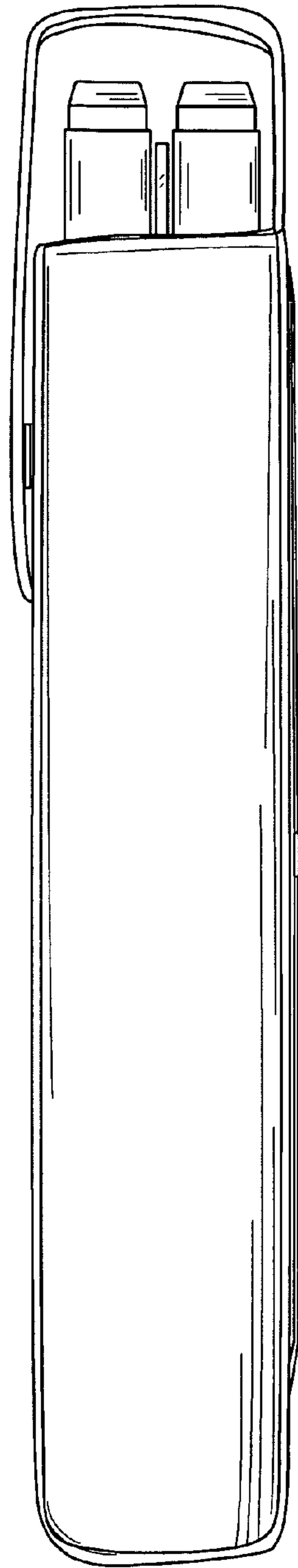

FIG. 8

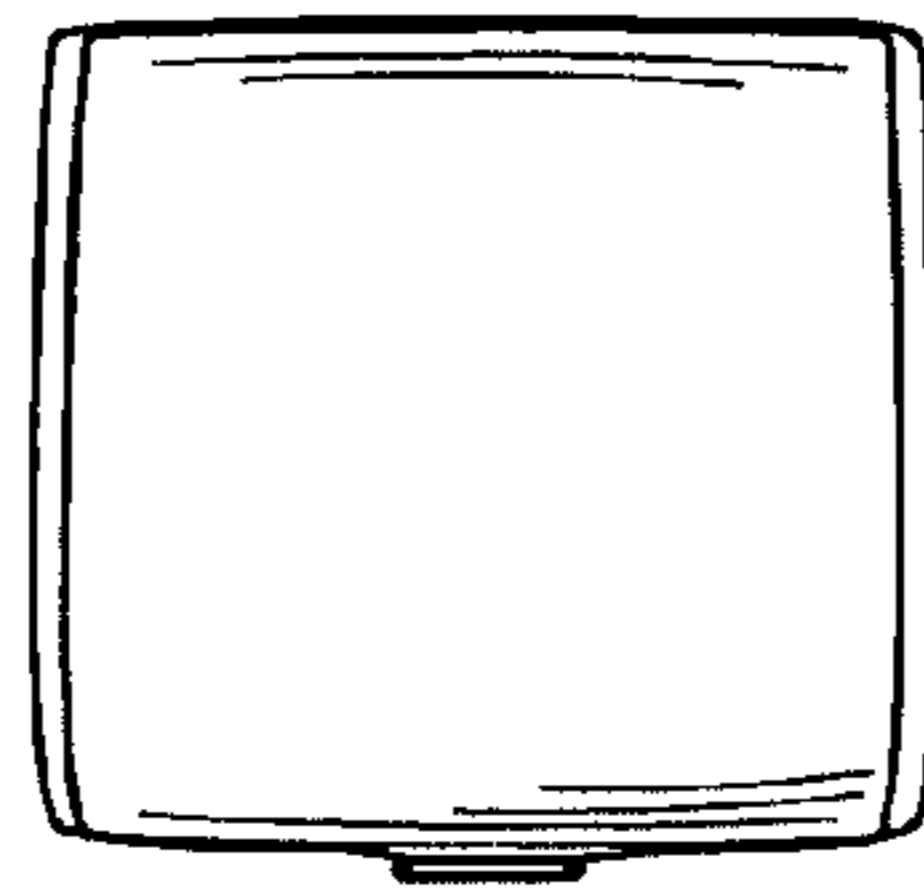

FIG. 9

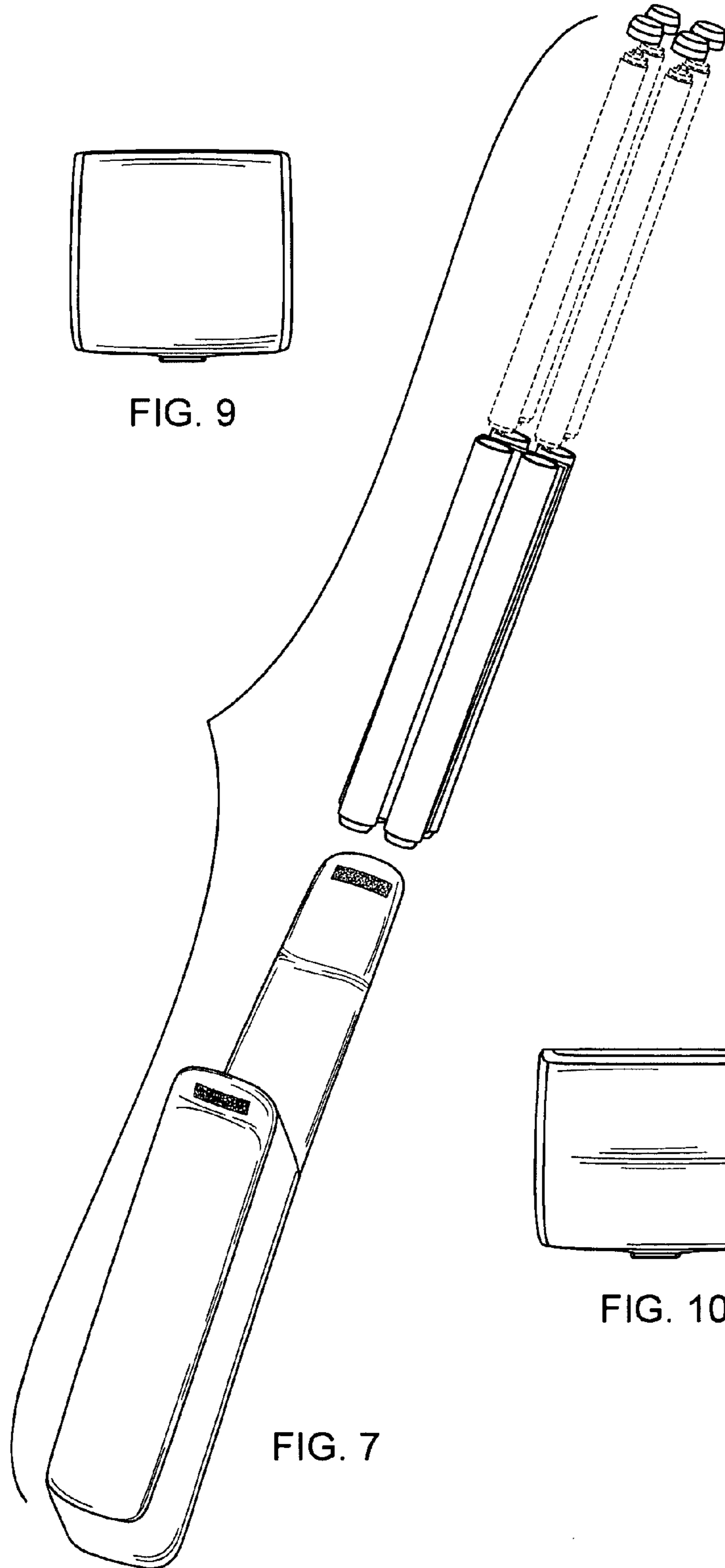

FIG. 7

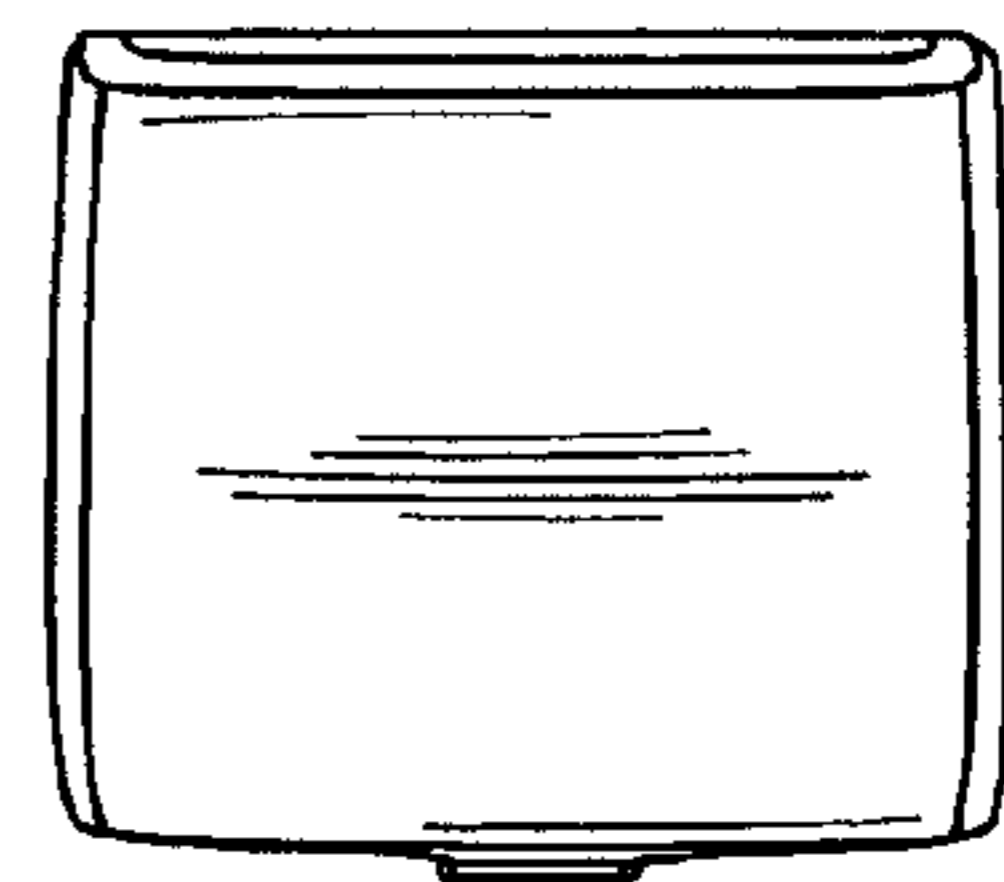

FIG. 10