



US00D592833S

(12) **United States Design Patent**
Bain

(10) **Patent No.:** **US D592,833 S**

(45) **Date of Patent:** **** May 26, 2009**

(54) **BALL CAP**

(76) **Inventor:** **Eddie M. Bain**, 3869 Liberty Square Dr.,
Apt. 506, Montgomery, AL (US) 36116

(**) **Term:** **14 Years**

(21) **Appl. No.:** **29/310,333**

(22) **Filed:** **Aug. 11, 2008**

(51) **LOC (9) Cl.** **02-03**

(52) **U.S. Cl.** **D2/869**

(58) **Field of Classification Search** D2/865,
D2/866, 868, 869, 870, 871, 872, 873, 875,
D2/876, 879, 882, 884, 893; 2/10, 12, 171,
2/171.1, 172, 173, 183, 184, 195.1, 195.2,
2/195.3, 200.1, 200.2, 200.3, 209.11, 209.12,
2/209.13, 209.4, 209.5

See application file for complete search history.

(56) **References Cited**

U.S. PATENT DOCUMENTS

2,908,012	A *	10/1959	Feldman	43/57.1
D230,103	S *	1/1974	Hyatt, Jr.	D29/105
4,716,599	A *	1/1988	Bell	2/195.1
5,343,567	A *	9/1994	Zumbiel	2/195.1
D352,378	S *	11/1994	Wise	D2/876
D360,972	S *	8/1995	Bennett, Jr.	D2/865
D364,287	S *	11/1995	Jurasinski	D6/451
D367,156	S *	2/1996	Dunlavey	D2/866
5,772,544	A *	6/1998	Yang	473/598
D396,944	S *	8/1998	Harriman	D2/884

5,966,743	A *	10/1999	Flann	2/209.13
6,571,396	B1 *	6/2003	Yan	2/195.1
6,663,519	B2 *	12/2003	Kuhn et al.	473/597
D499,231	S *	12/2004	Toppel	D2/882
D539,012	S *	3/2007	Evans	D2/882
D539,049	S *	3/2007	Zimmermann	D6/358
D540,512	S *	4/2007	Chesser	D2/882
D572,919	S *	7/2008	Gao	D6/358
D580,634	S *	11/2008	Robinson	D2/869

* cited by examiner

Primary Examiner—Elizabeth A Albert

Assistant Examiner—Karen E Eldridge Powers

(74) *Attorney, Agent, or Firm*—Ronald R. Kilponen

(57) **CLAIM**

I claim the ornamental design for the ball cap, as shown and described.

DESCRIPTION

FIG. 1 is a right side view of the ball cap showing the new design:

FIG. 2 is a left side view thereof;

FIG. 3 is a front view thereof;

FIG. 4 is a rear view thereof;

FIG. 5 is a top view thereof;

FIG. 6 is a bottom view thereof; and,

FIG. 7 is a sectional view along 7—7 of FIG. 2 thereof.

1 Claim, 5 Drawing Sheets

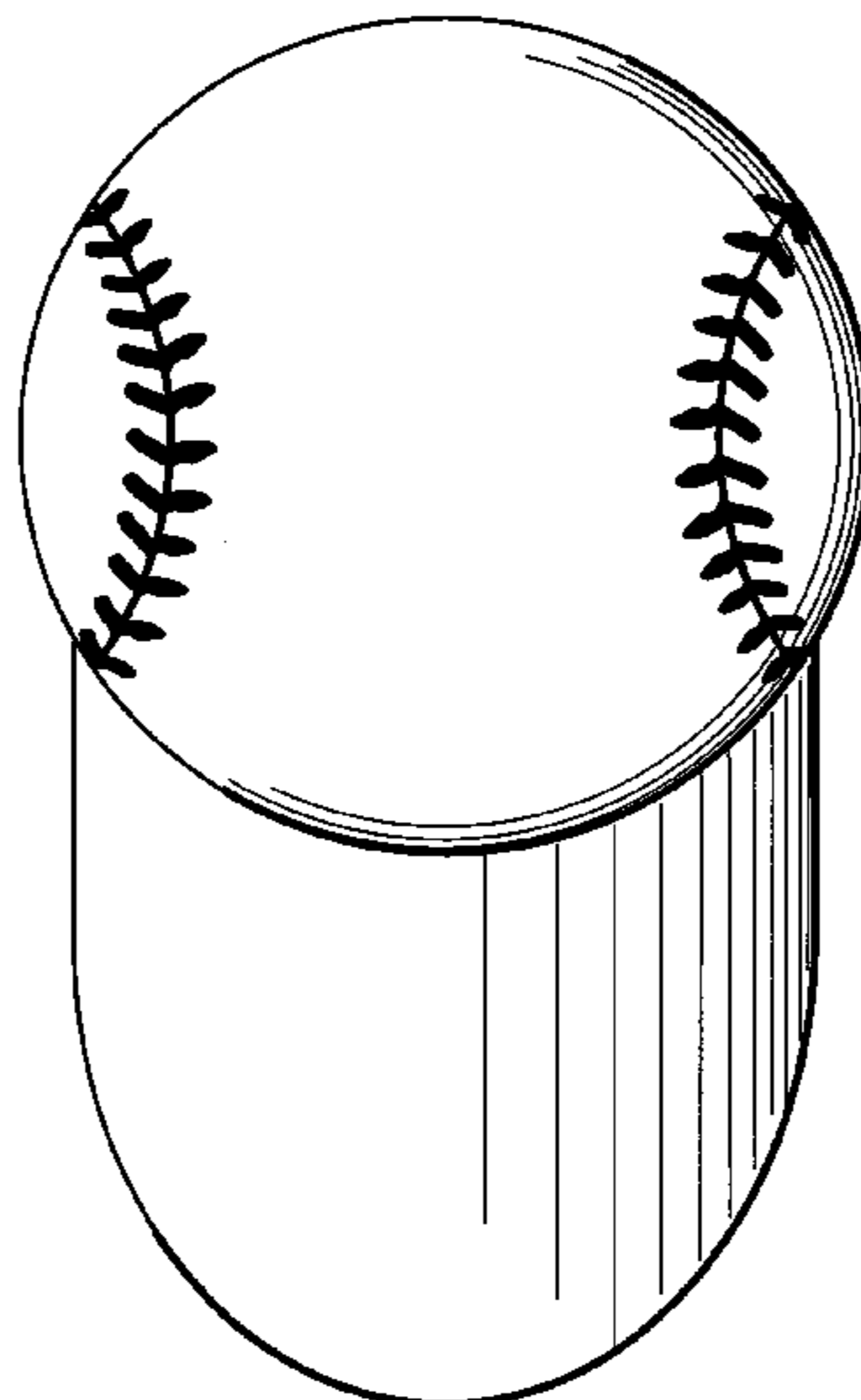
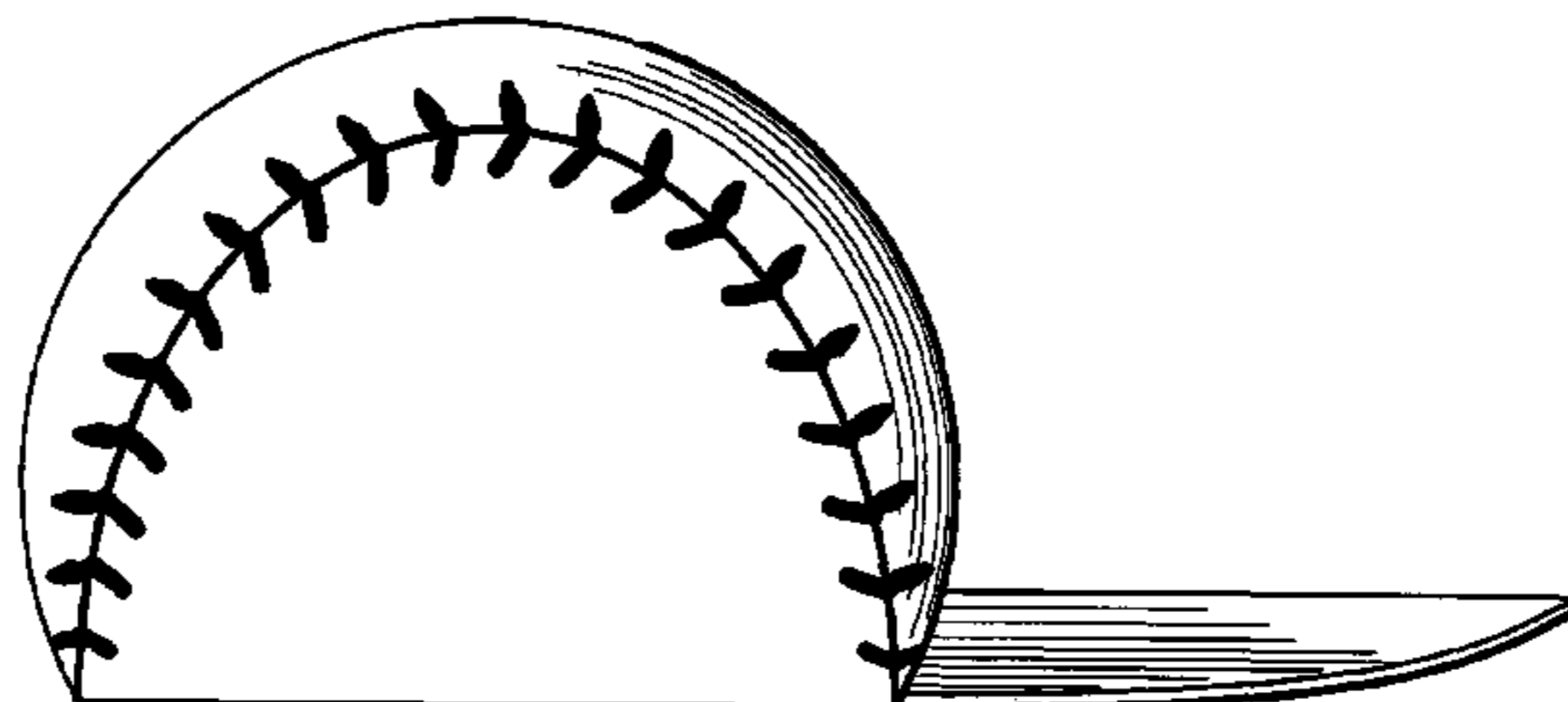

FIG. 1

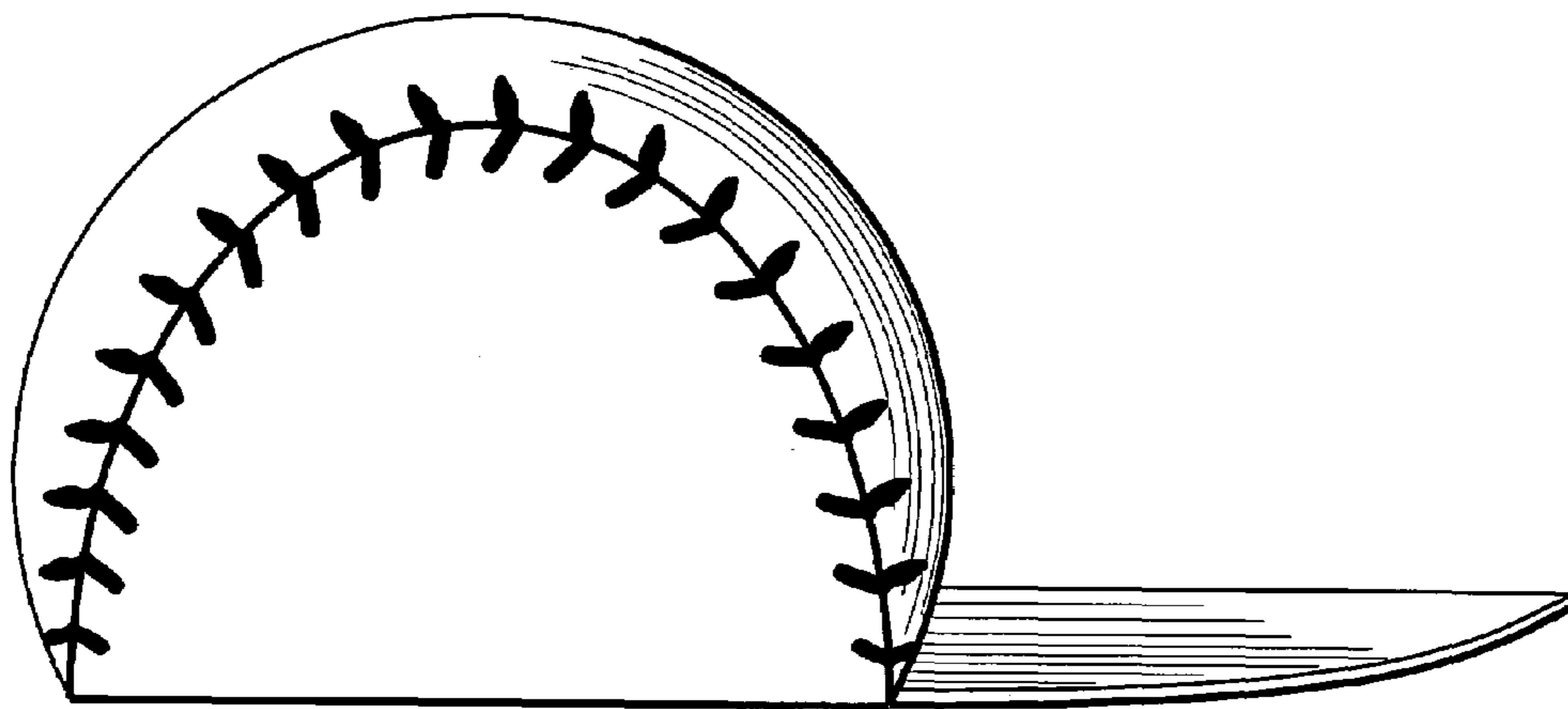

FIG. 2

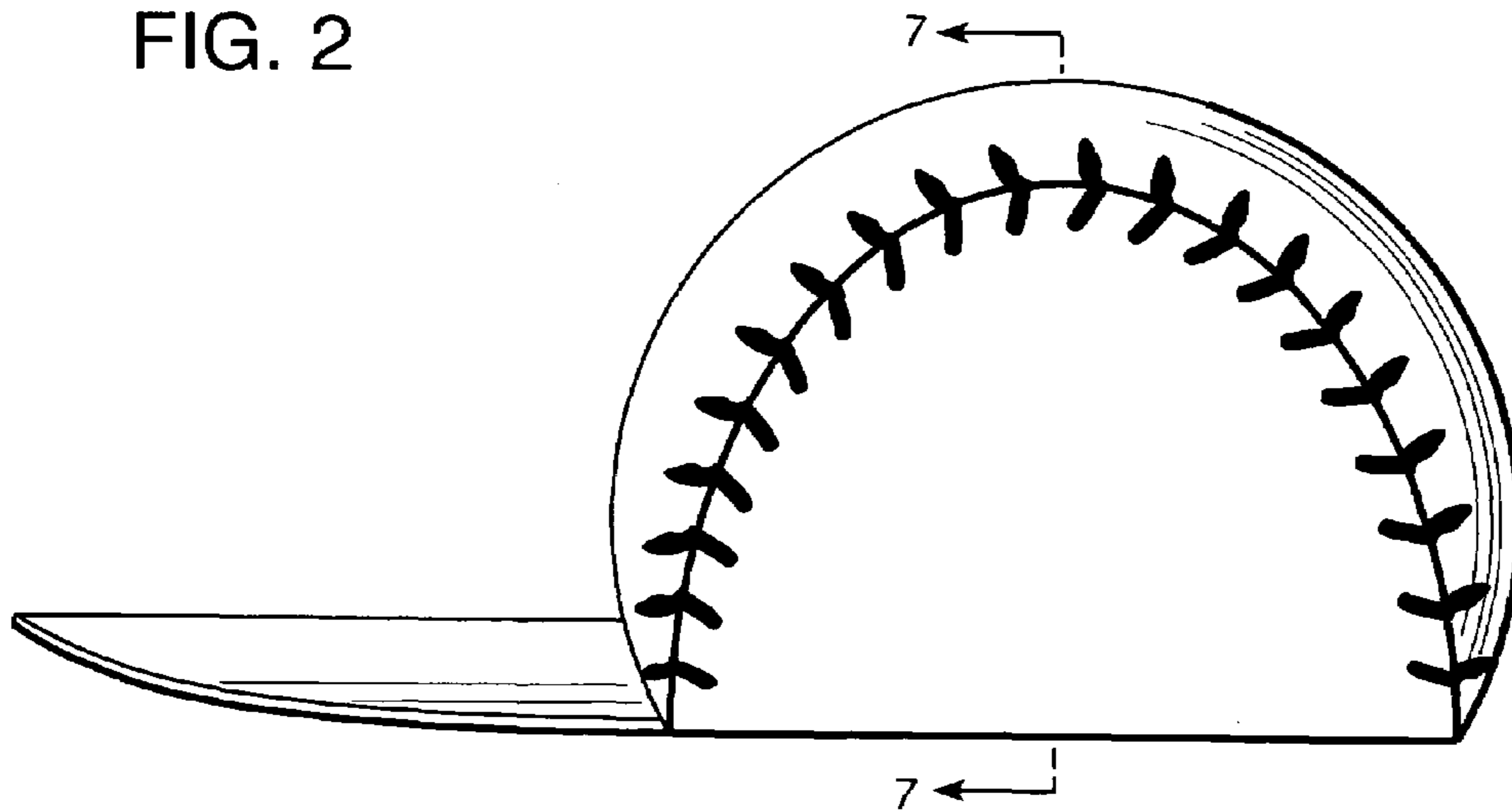

FIG. 3

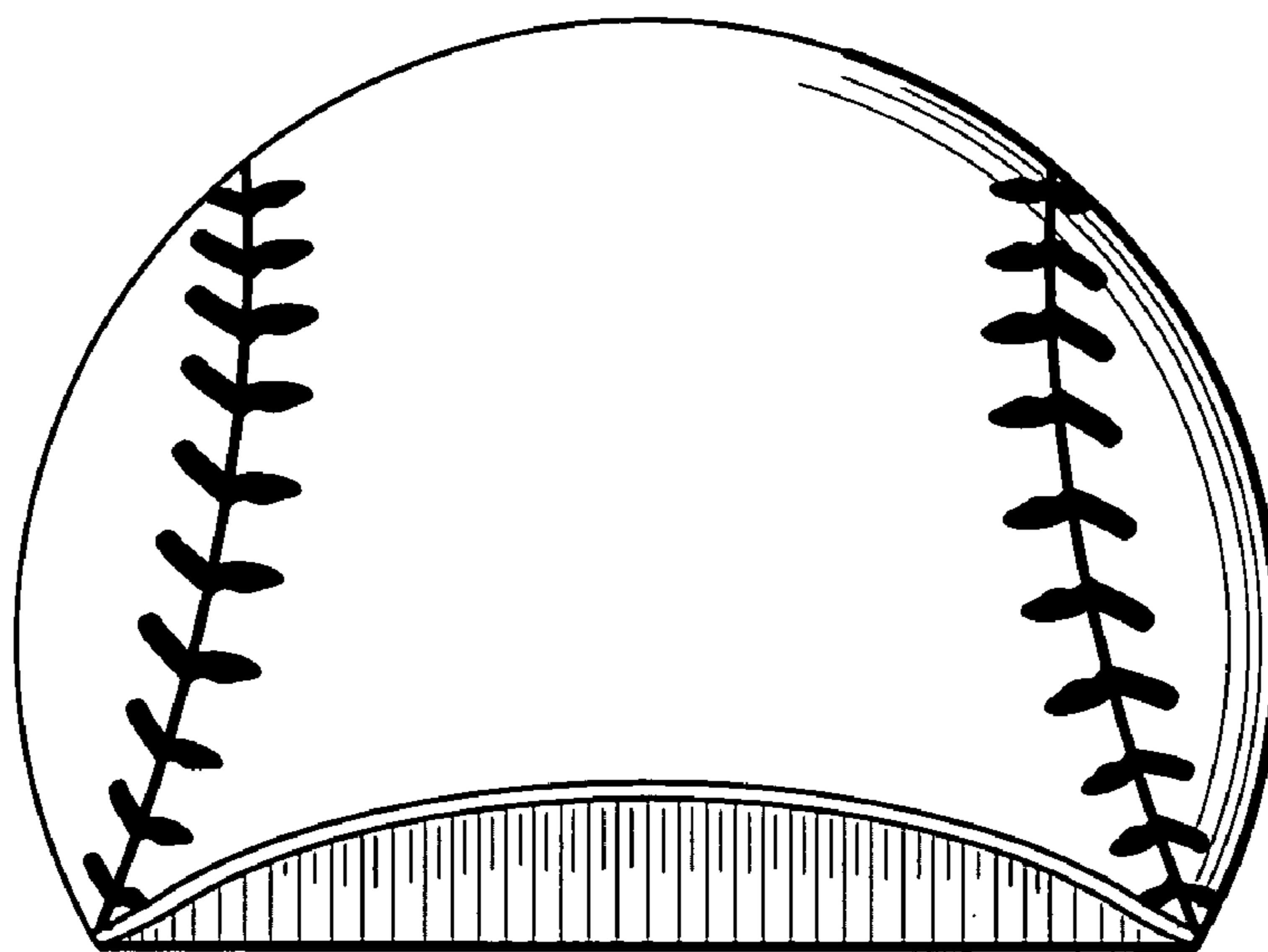

FIG. 4

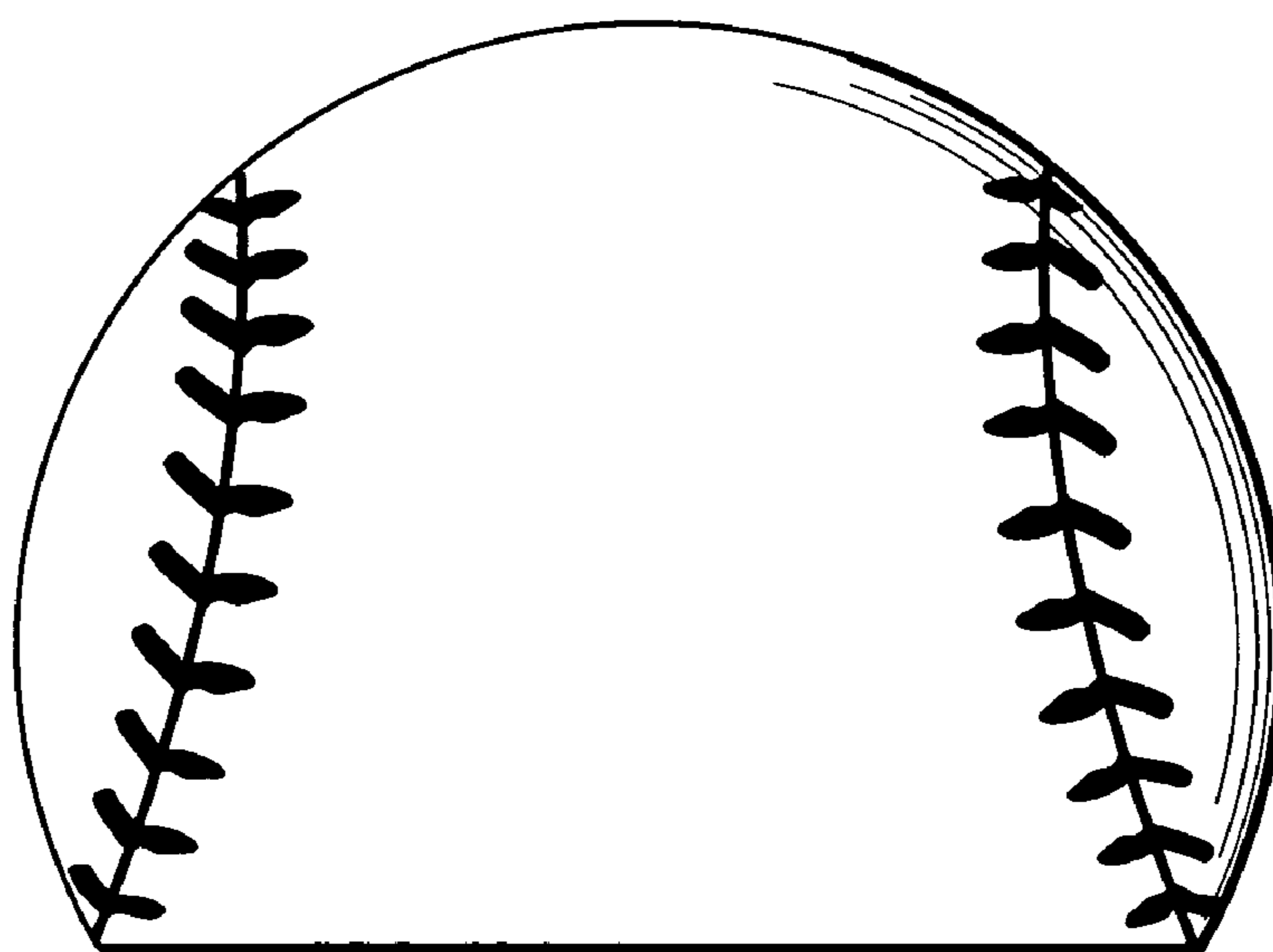

FIG. 5

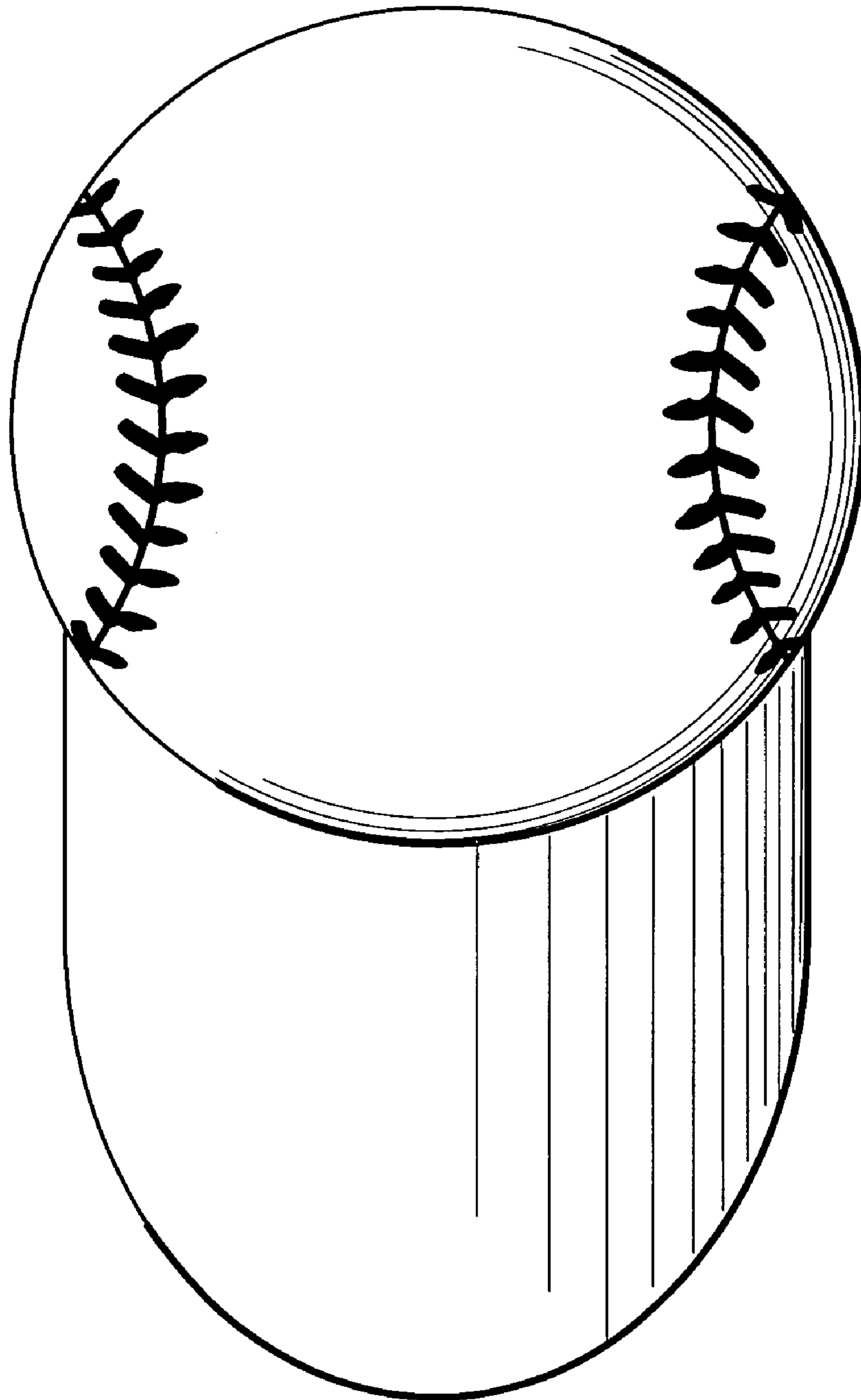

FIG. 6

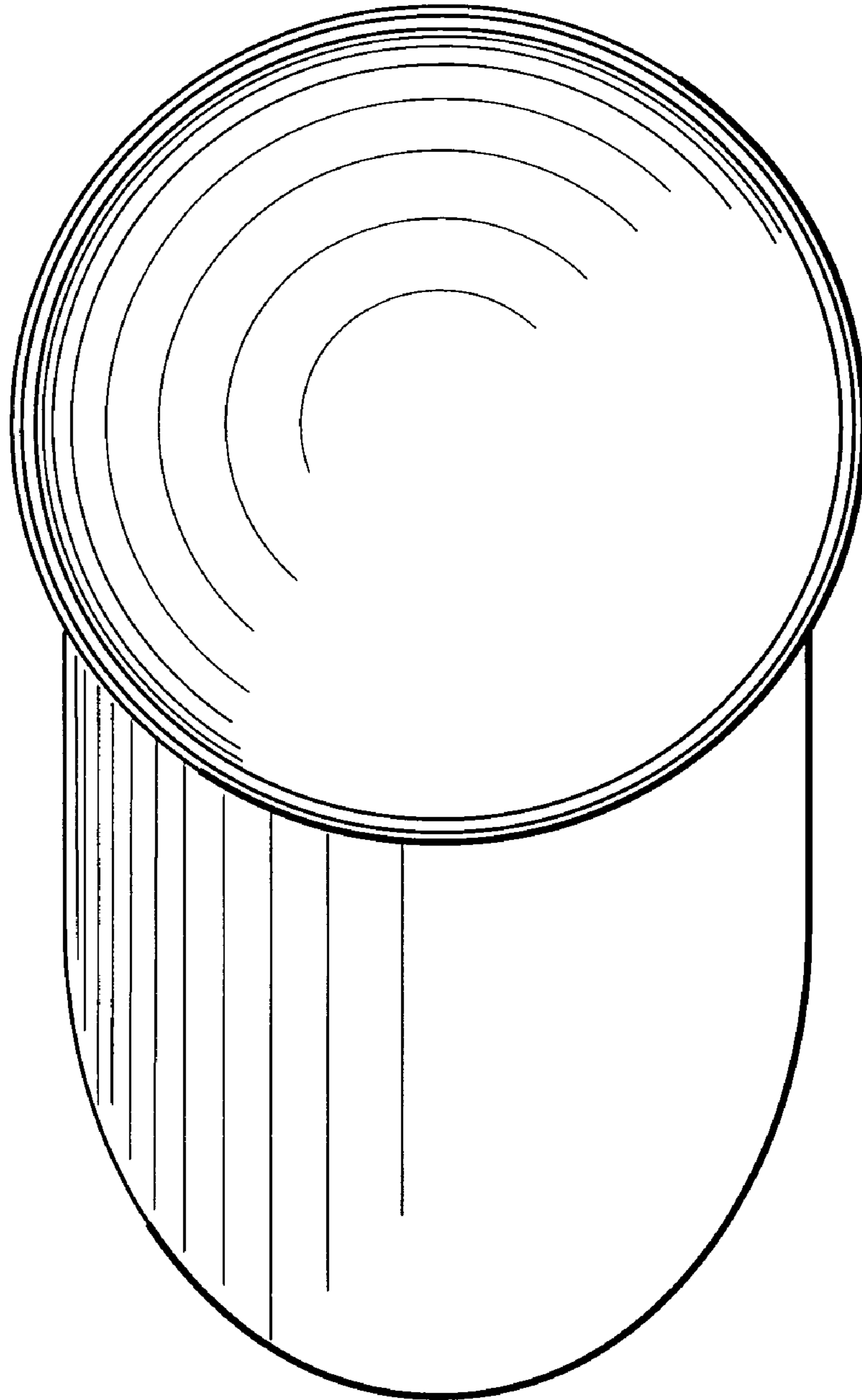

FIG. 7

