

US00D592811S

(12) **United States Design Patent**
Juhlin

(10) **Patent No.:** **US D592,811 S**

(45) **Date of Patent:** **** May 19, 2009**

(54) **WELDING HELMET COLLAR PORTION**

(75) **Inventor:** **Oskar E. Juhlin**, Gustavsberg (SE)

(73) **Assignee:** **3M Innovative Properties Company**,
St. Paul, MN (US)

(**) **Term:** **14 Years**

(21) **Appl. No.:** **29/297,648**

(22) **Filed:** **Nov. 15, 2007**

(51) **LOC (9) Cl.** **29-02**

(52) **U.S. Cl.** **D29/122**

(58) **Field of Classification Search** D29/108,
D29/110, 111, 122; 2/7, 8.1–8.8, 9–11, 15,
2/6.3, 6.5, 6.7, 424, 427, 429, 5; 128/857,
128/858, 206.28, 207.11, 207.17, 201.23,
128/201.24, 201.25, 206.21, 206.23, 206.24;
D24/191

See application file for complete search history.

(56) **References Cited**

U.S. PATENT DOCUMENTS

D393,933 S *	4/1998	Huh	D29/110
D394,732 S *	5/1998	Huh	D29/110
D398,421 S *	9/1998	Crafoord et al.	D29/110
D517,745 S *	3/2006	Lee et al.	D29/122
D524,992 S	7/2006	Belin et al.		
D525,395 S	7/2006	Fridholm et al.		

D526,097 S *	8/2006	Lilenthal et al.	D29/122
D532,560 S	11/2006	Fredriksson et al.		
D532,939 S	11/2006	Juhlin et al.		
D533,313 S	12/2006	Mases et al.		
D540,990 S *	4/2007	Huh	D29/110
D553,802 S *	10/2007	Huh	D29/110
D565,800 S *	4/2008	Wang	D29/110

* cited by examiner

Primary Examiner—Ruth McInroy

(74) *Attorney, Agent, or Firm*—Anna A. Wetzels

(57) **CLAIM**

The ornamental design for a welding helmet collar portion, as shown and described.

DESCRIPTION

FIG. 1 is a perspective view, showing the new design for a welding helmet collar portion;

FIG. 2 is a front view thereof;

FIG. 3 is a rear view thereof;

FIG. 4 is a left side view, the right side view being a mirror image thereof;

FIG. 5 is a top view thereof; and,

FIG. 6 is a bottom view thereof.

The details shown in broken lines form no part of the claimed design.

1 Claim, 6 Drawing Sheets

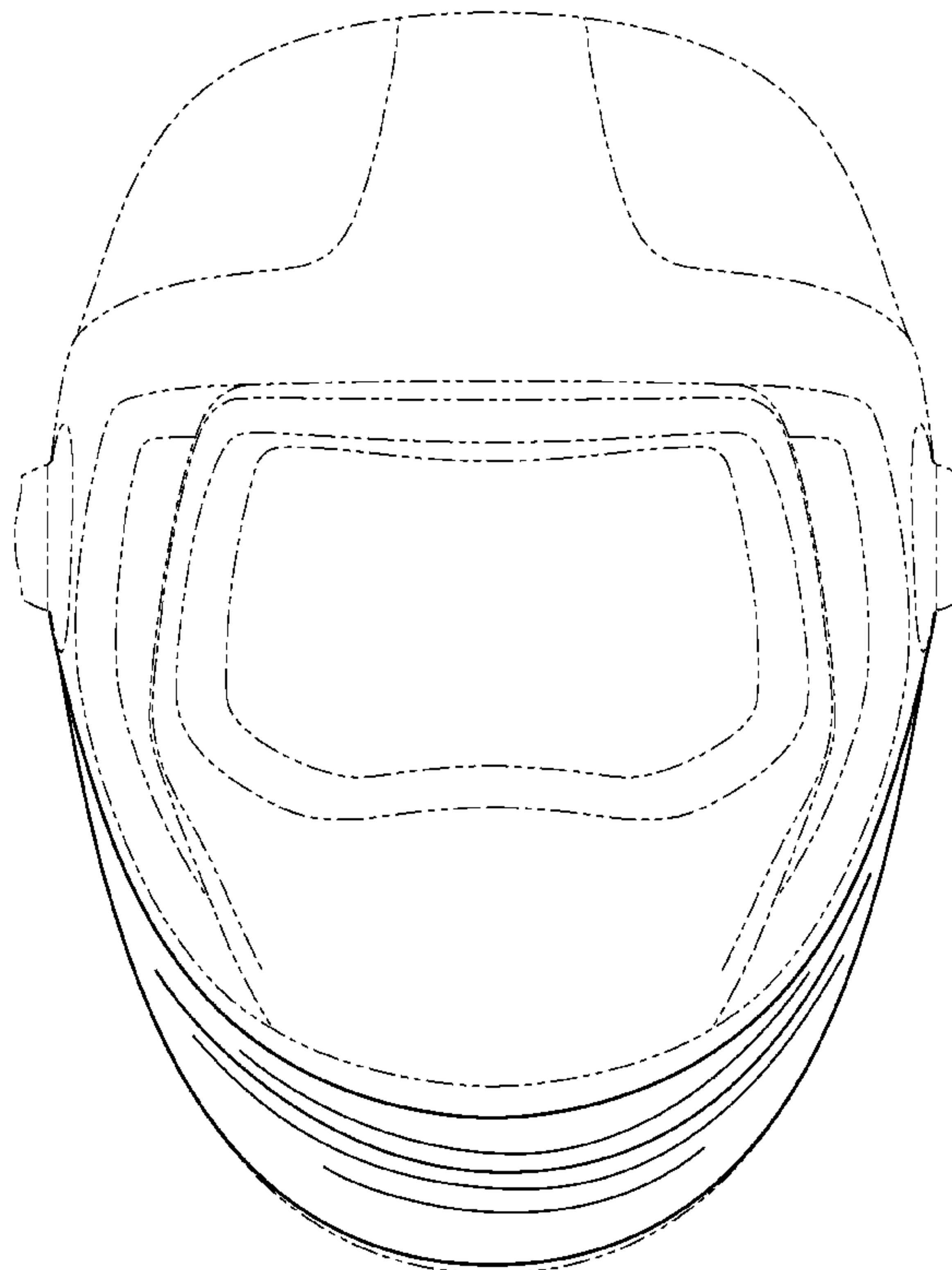
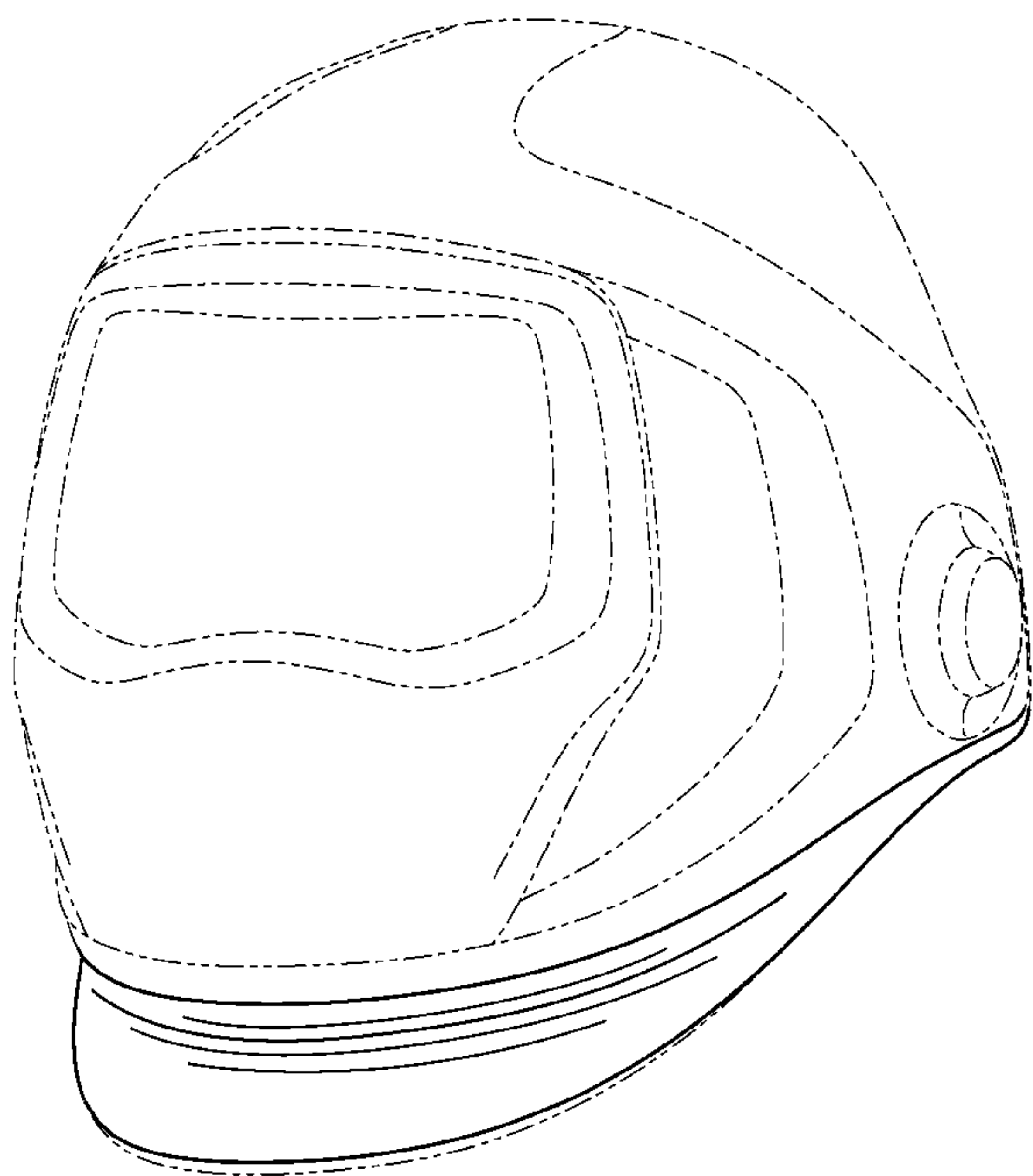



Fig. 1

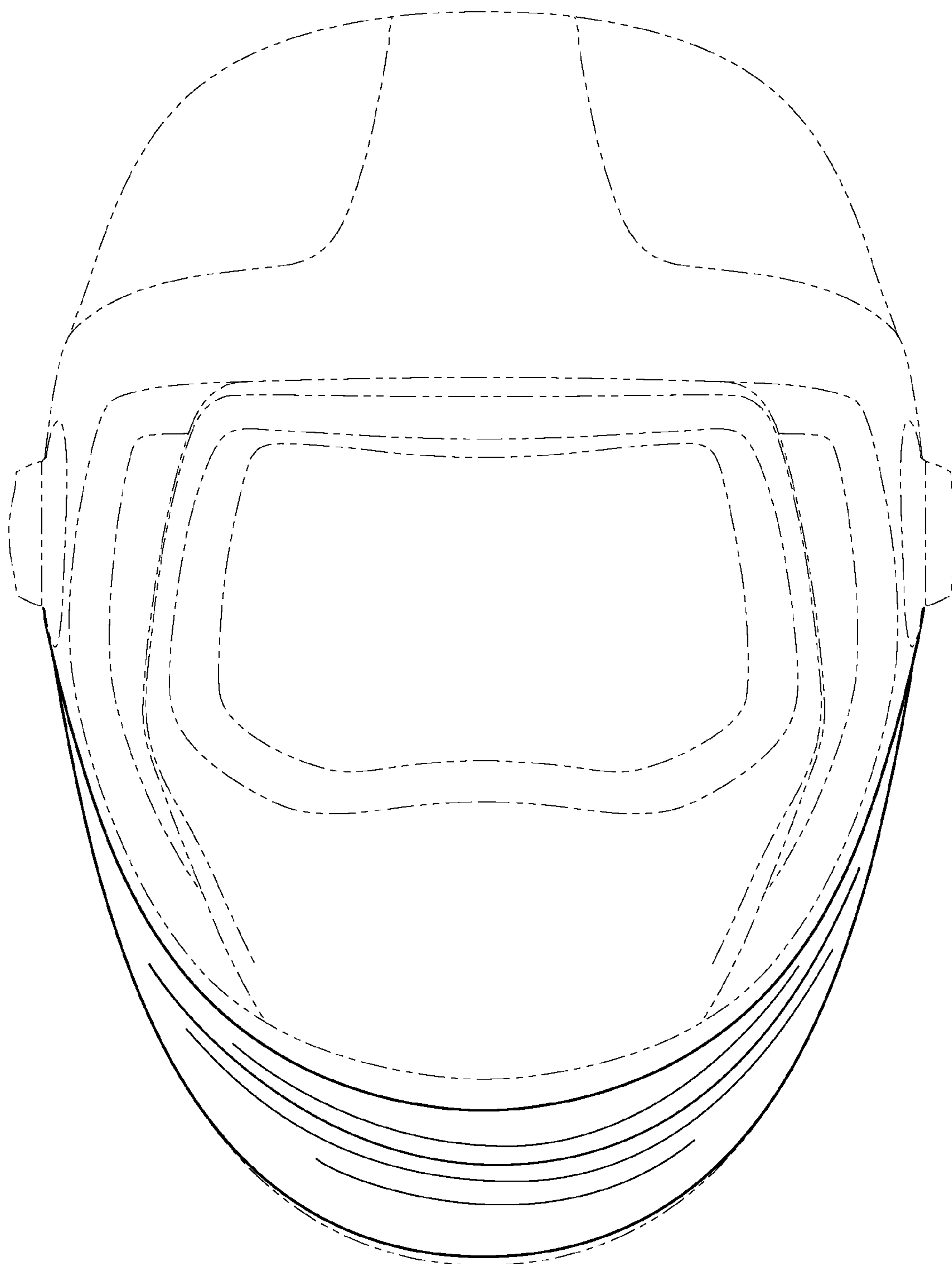

Fig. 2

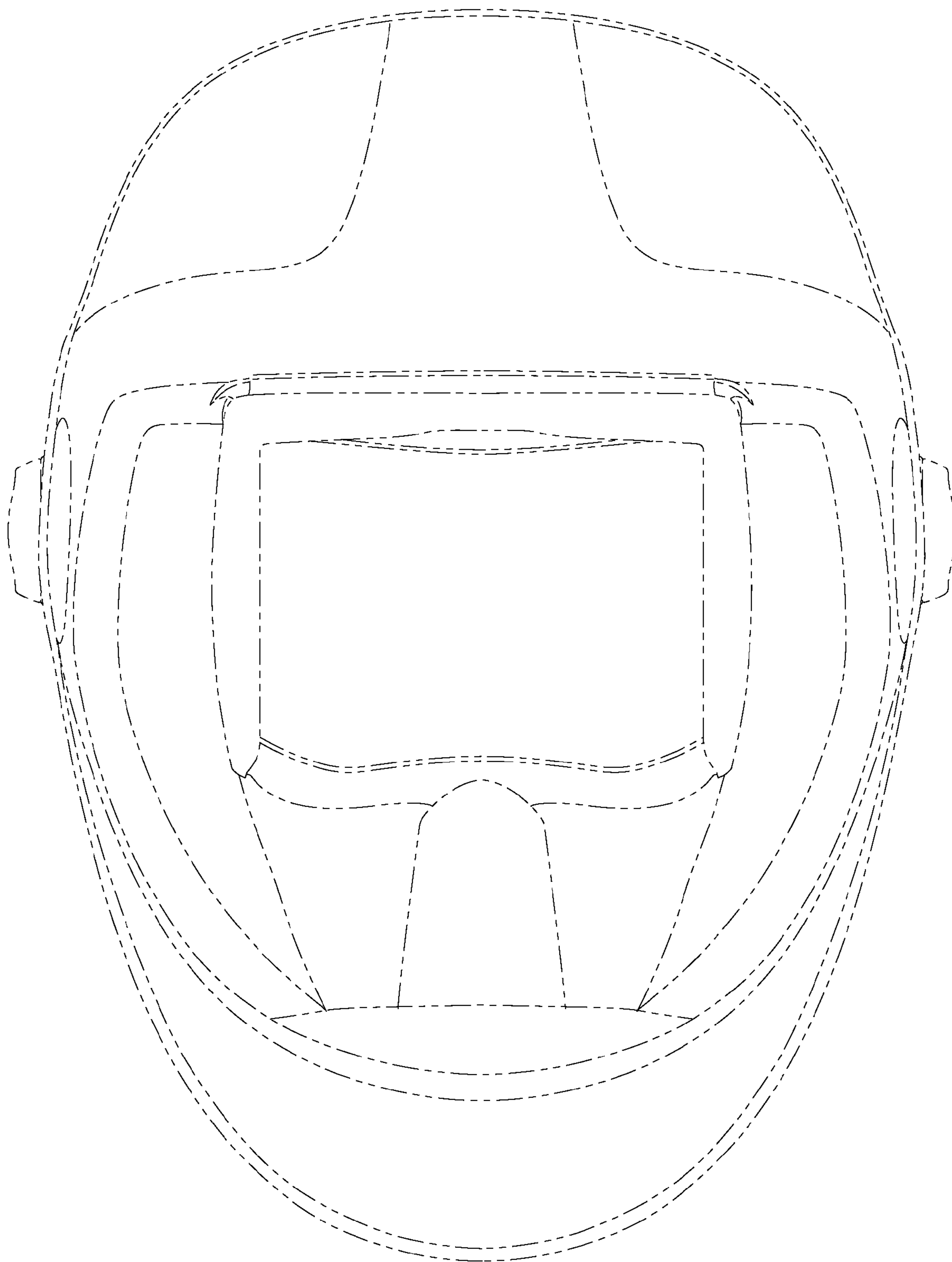

Fig. 3

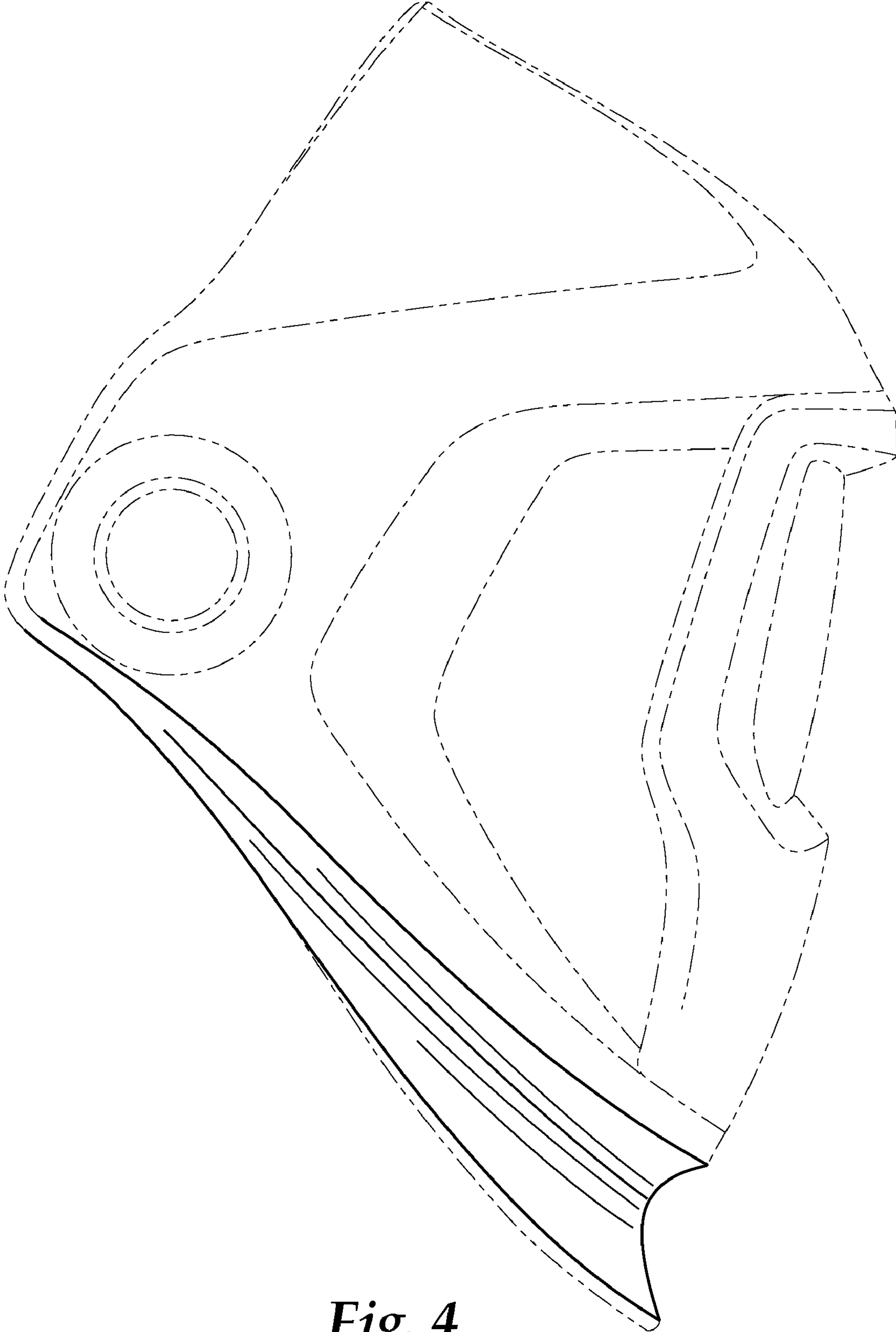

Fig. 4

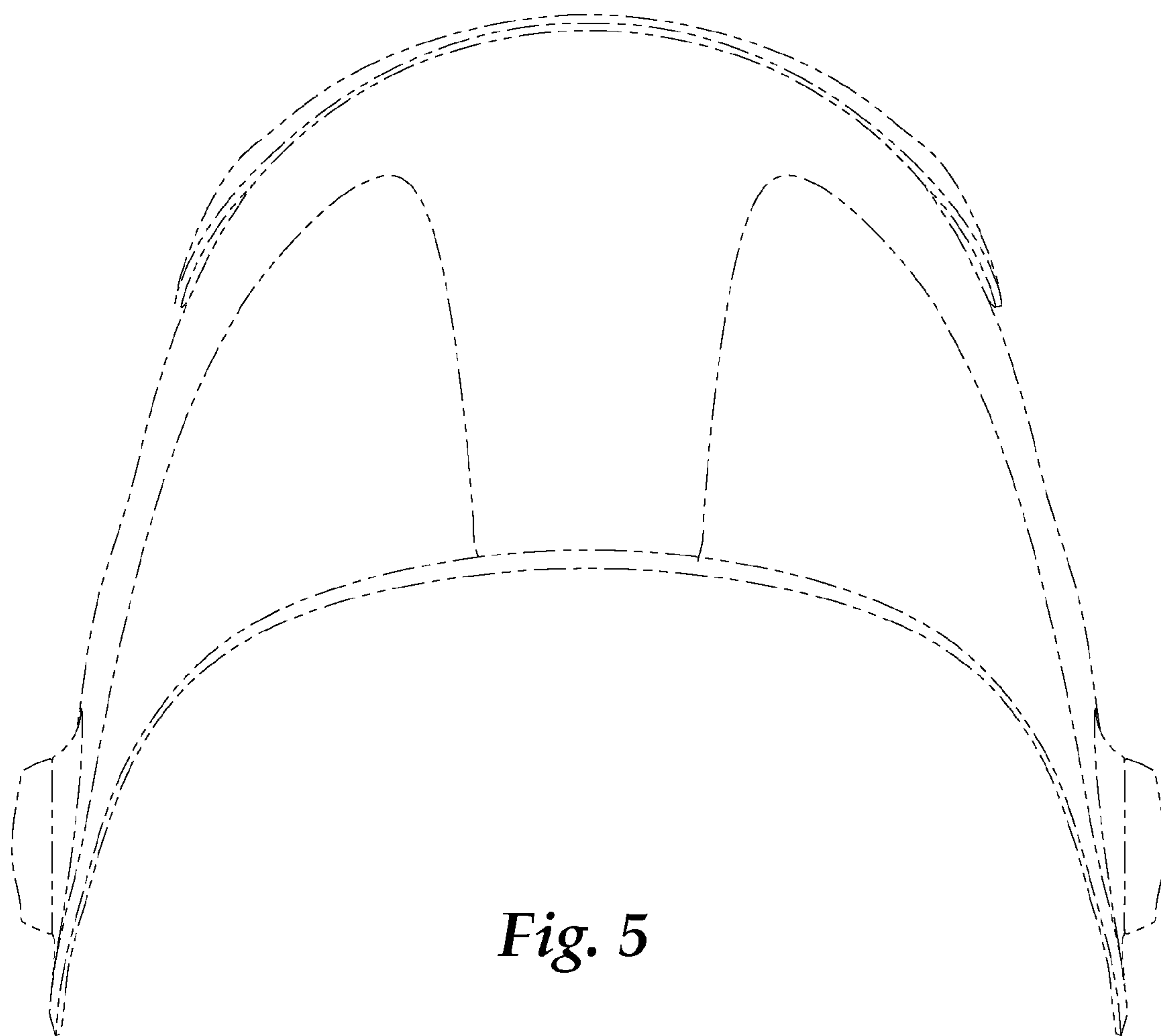

Fig. 5

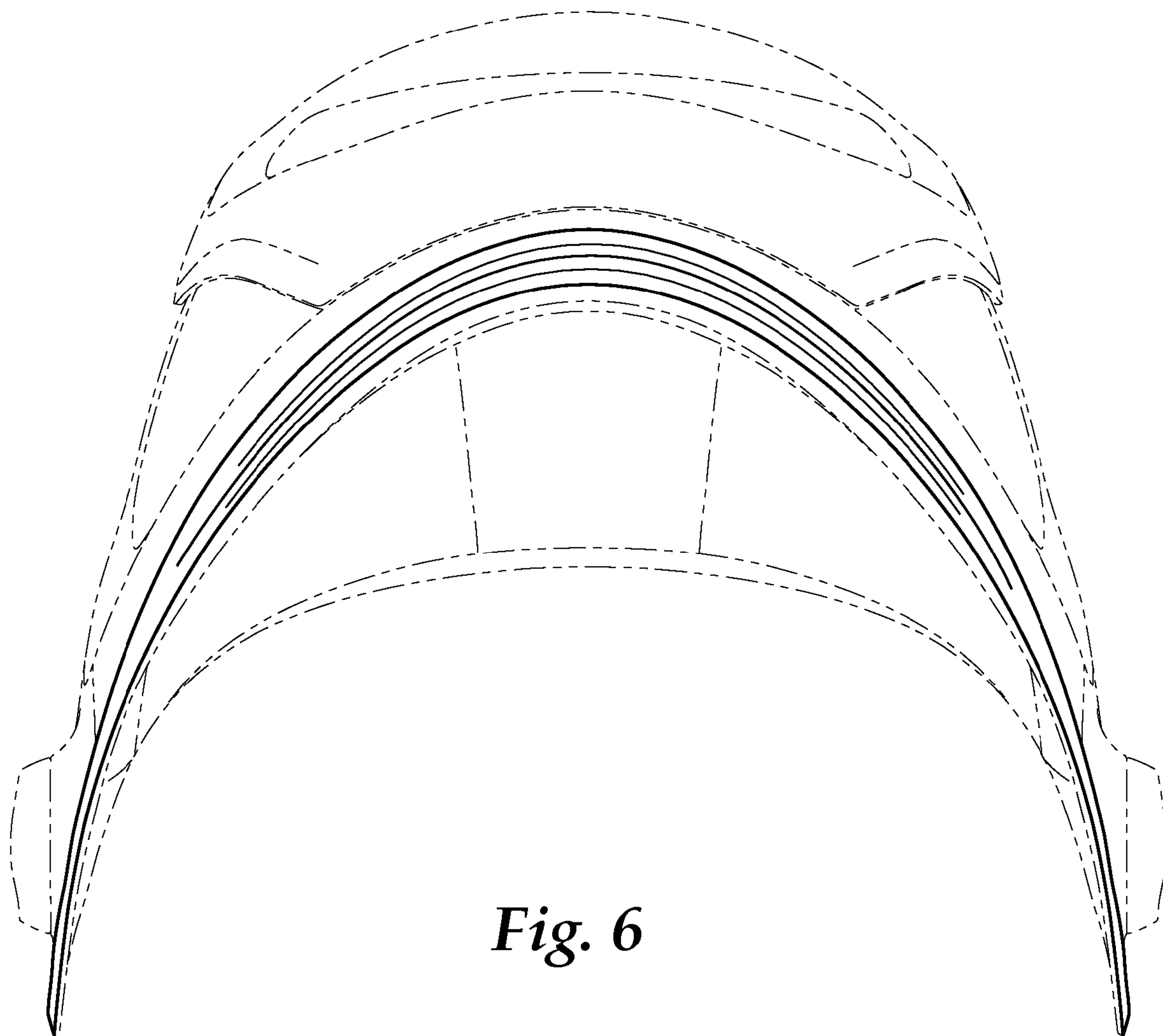

Fig. 6