



US00D592802S

(12) **United States Design Patent**
Chuan

(10) **Patent No.:** **US D592,802 S**

(45) **Date of Patent:** **** May 19, 2009**

(54) **LIGHTER**

D581,094 S * 11/2008 Smith D27/157

(76) Inventor: **Chin-Chung Chuan**, No. 13, Alley 41,
Lane 8, Tainmu E. Rd., Shihlin Dist.,
Taipei City 111 (TW)

* cited by examiner

Primary Examiner—Jennifer Rivard
(74) *Attorney, Agent, or Firm*—Banger Shia

(**) Term: **14 Years**

(21) Appl. No.: **29/331,553**

(22) Filed: **Jan. 28, 2009**

(57) **CLAIM**

The ornamental design for a lighter, as shown and described.

(51) **LOC (9) Cl.** **27-05**

(52) **U.S. Cl.** **D27/154; D27/157; D27/155**

(58) **Field of Classification Search** D27/139–161;
431/253–256, 273–277, 129, 143, 153

See application file for complete search history.

DESCRIPTION

FIG. 1 is a perspective view of a lighter showing my new design;

FIG. 2 is a front elevational view thereof;

FIG. 3 is a rear elevational view thereof;

FIG. 4 is a left side elevational view thereof;

FIG. 5 is a right side elevational view thereof;

FIG. 6 is a top plan view thereof; and,

FIG. 7 is a bottom plan view thereof.

(56) **References Cited**

U.S. PATENT DOCUMENTS

D520,675 S *	5/2006	Chen	D27/148
D526,440 S *	8/2006	Smith	D27/157
D537,978 S *	3/2007	Chen	D27/148
D577,151 S *	9/2008	Smith	D27/195

1 Claim, 4 Drawing Sheets

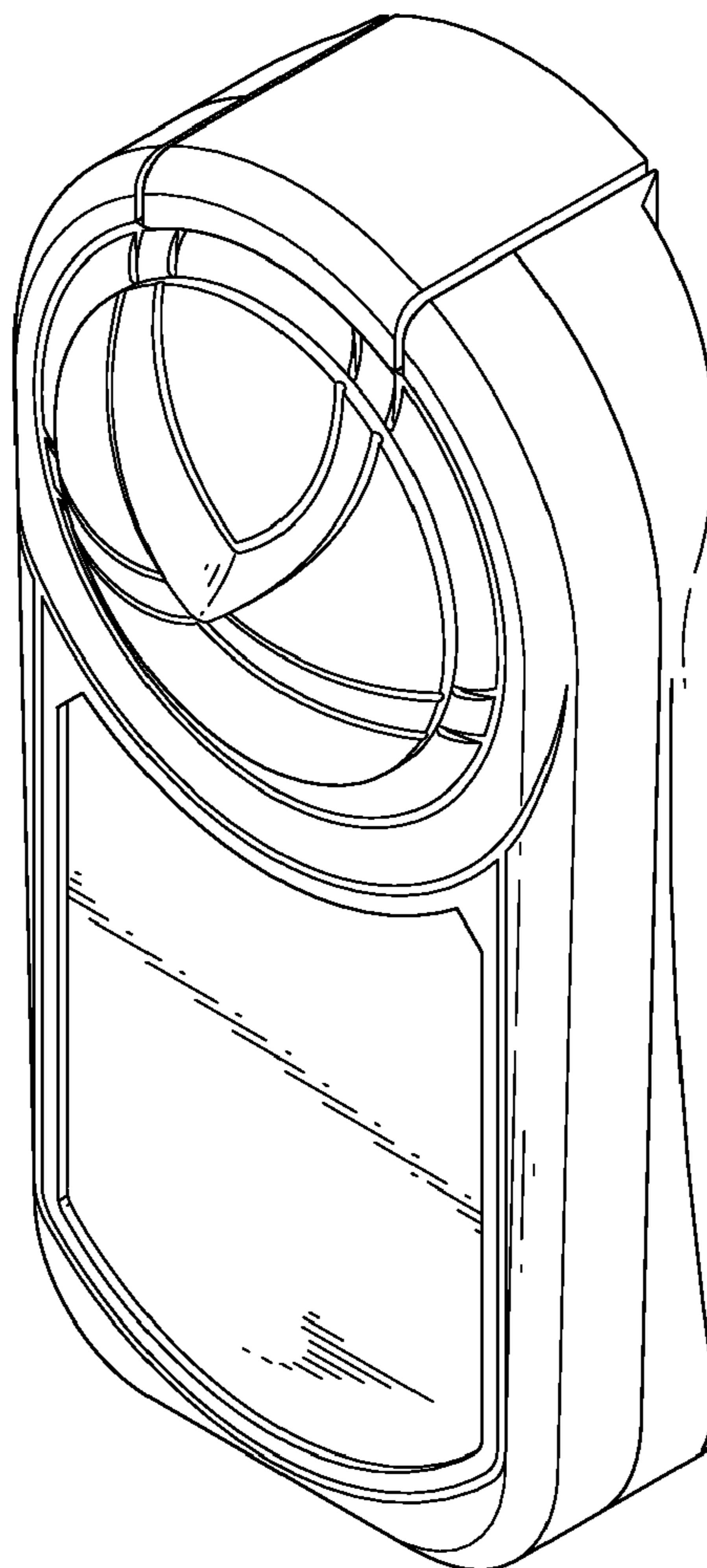

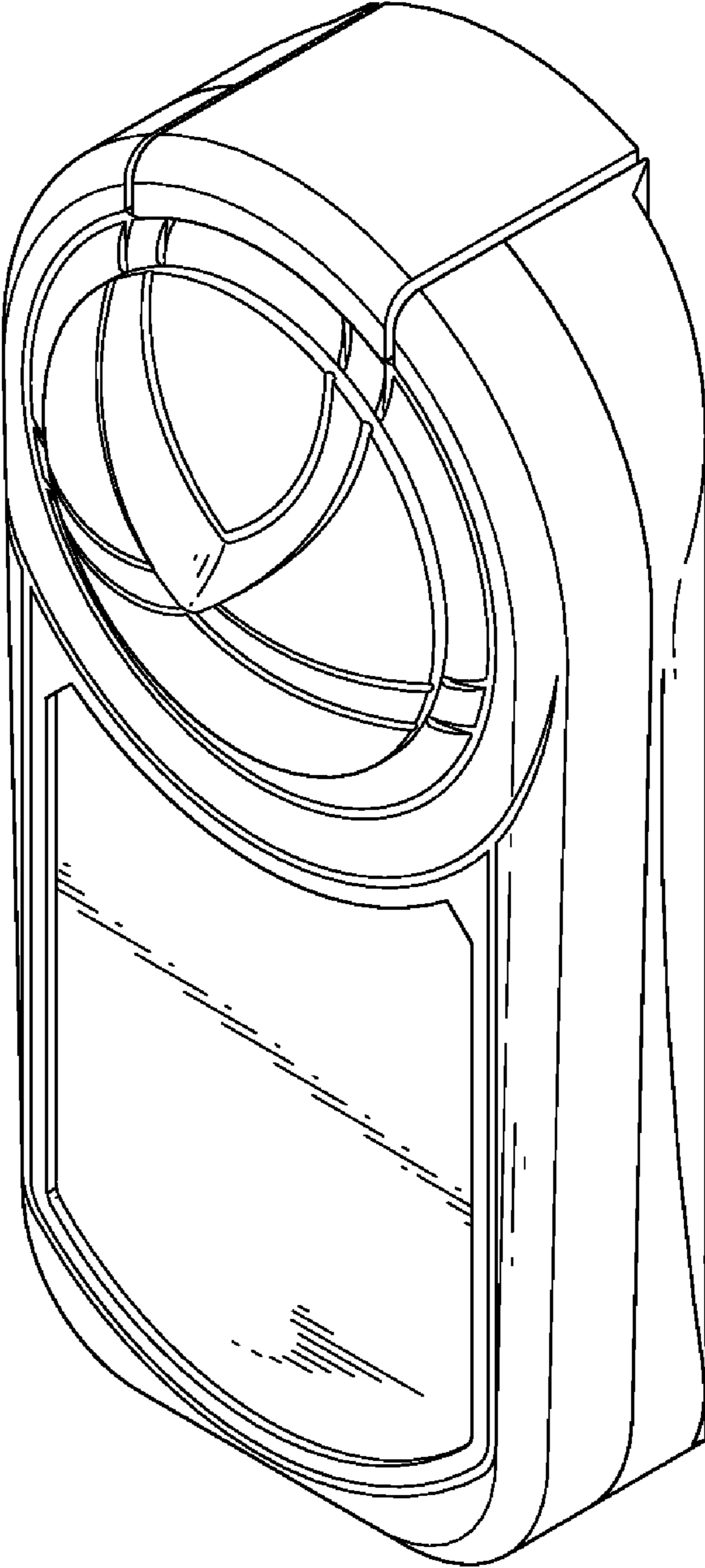

FIG. 1

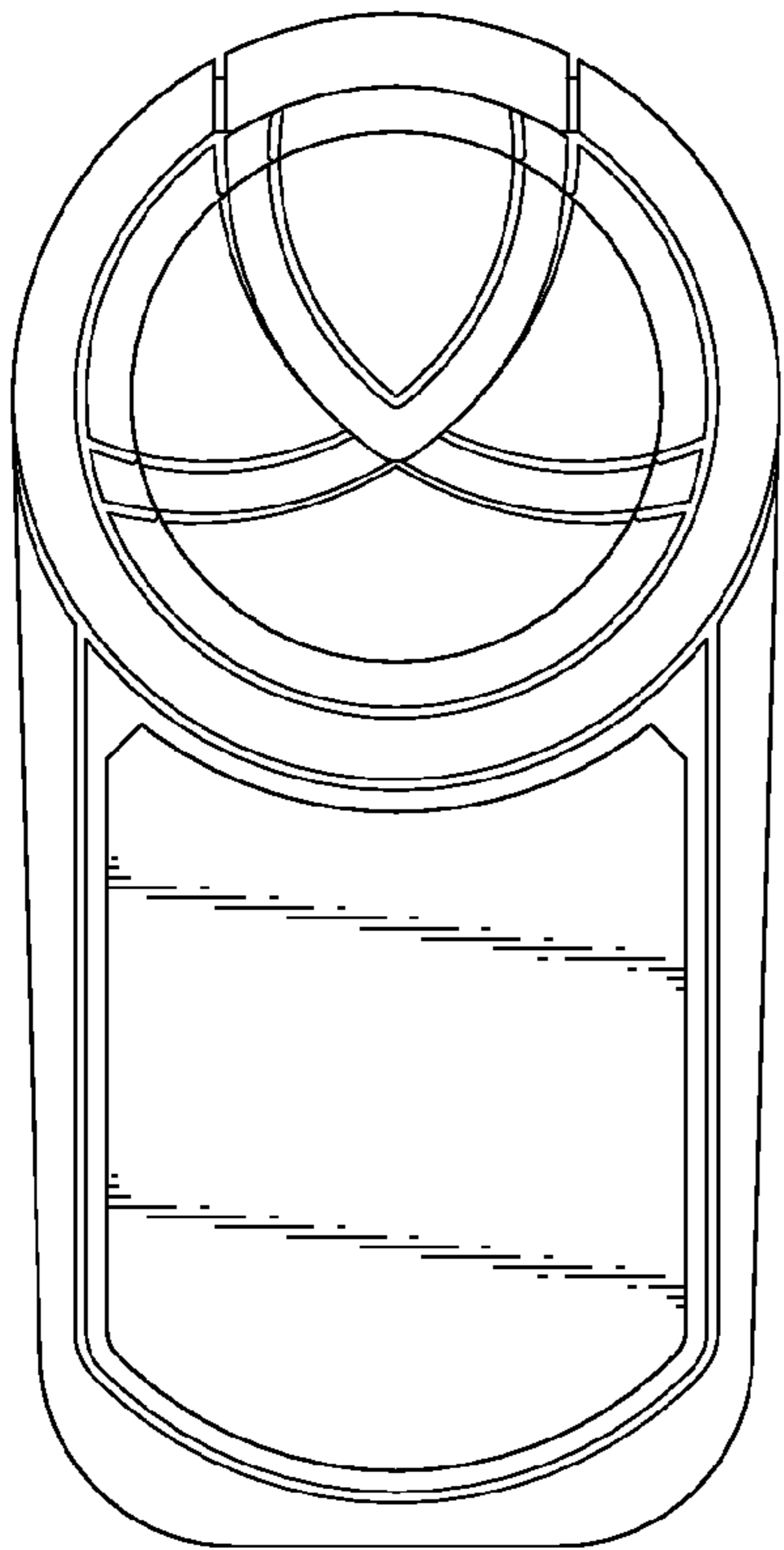

FIG. 2

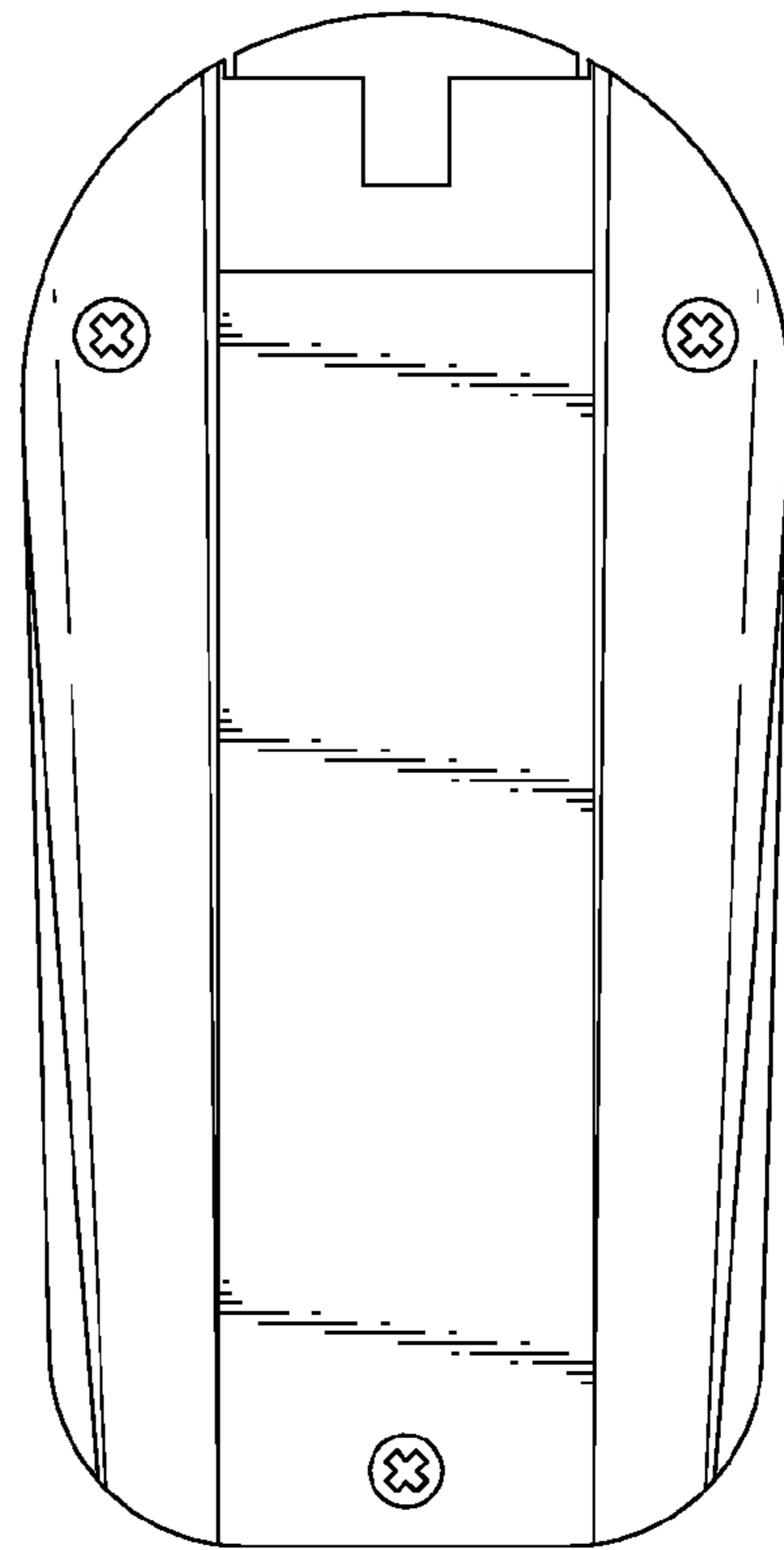

FIG. 3

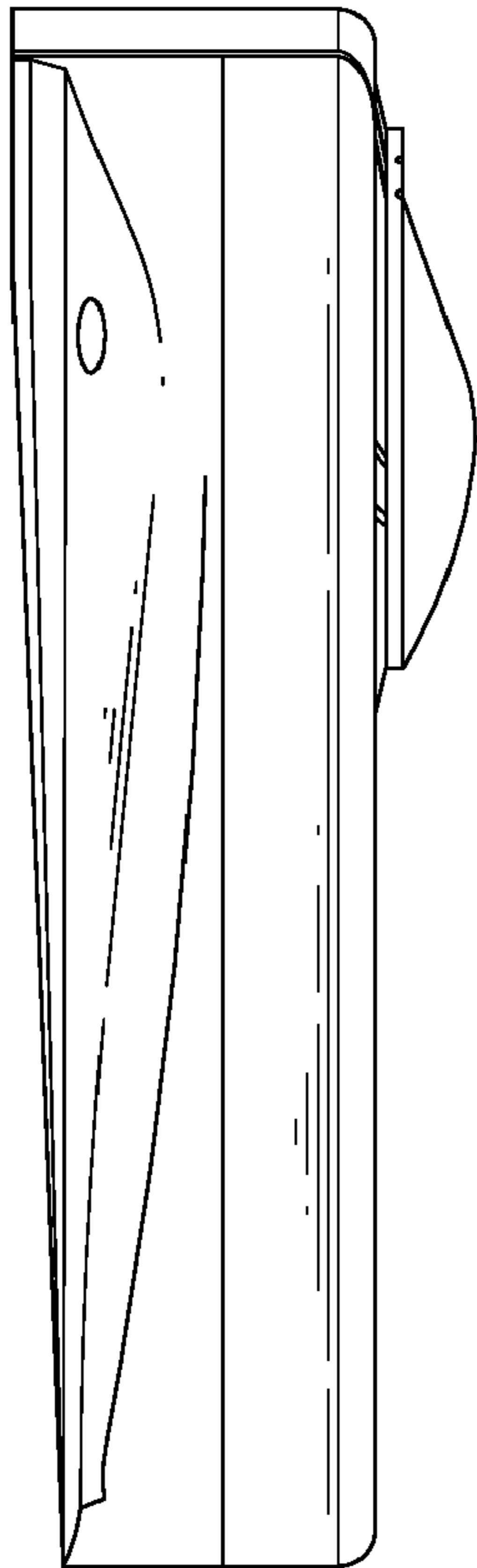

FIG. 4



FIG. 5

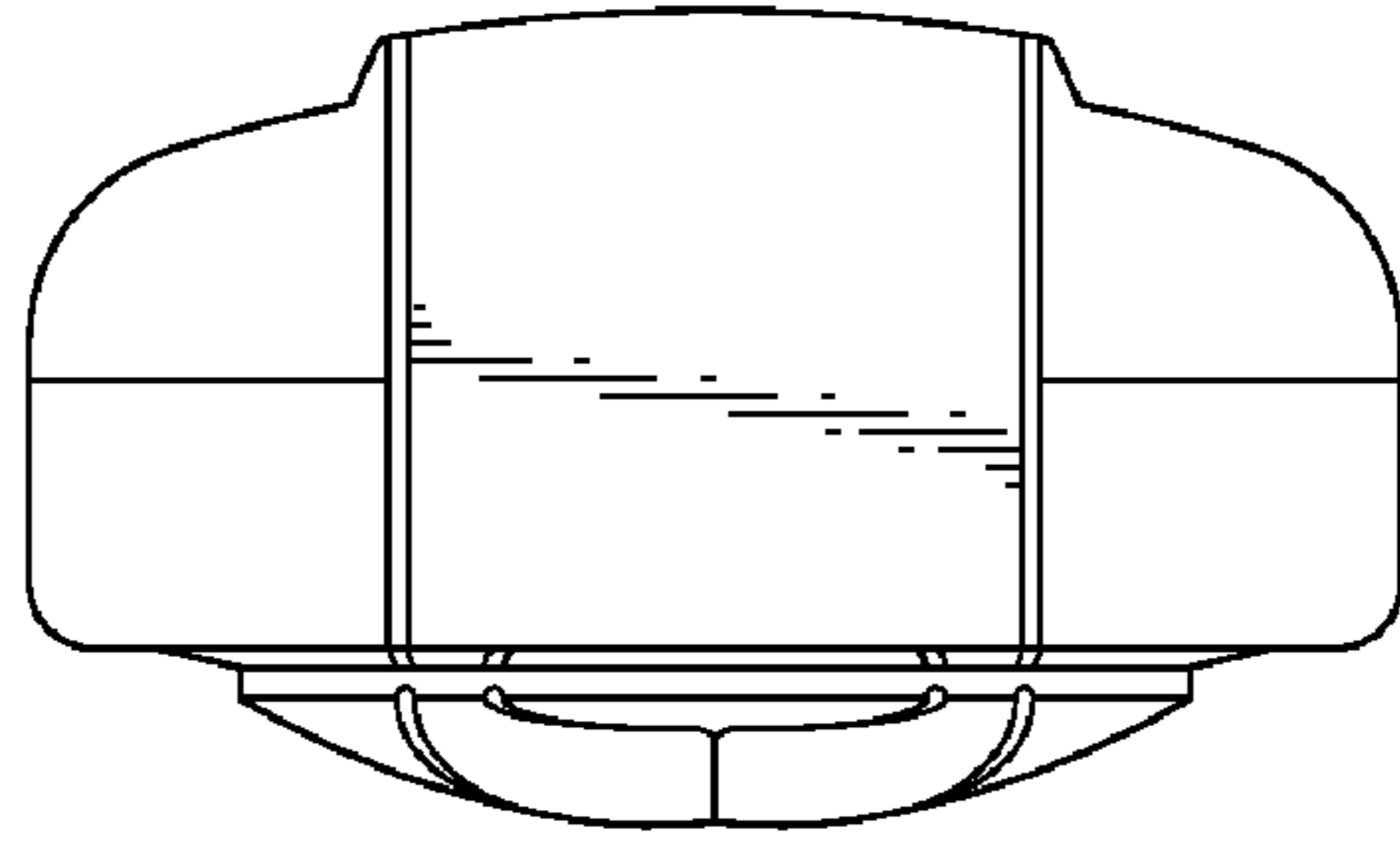

FIG. 6

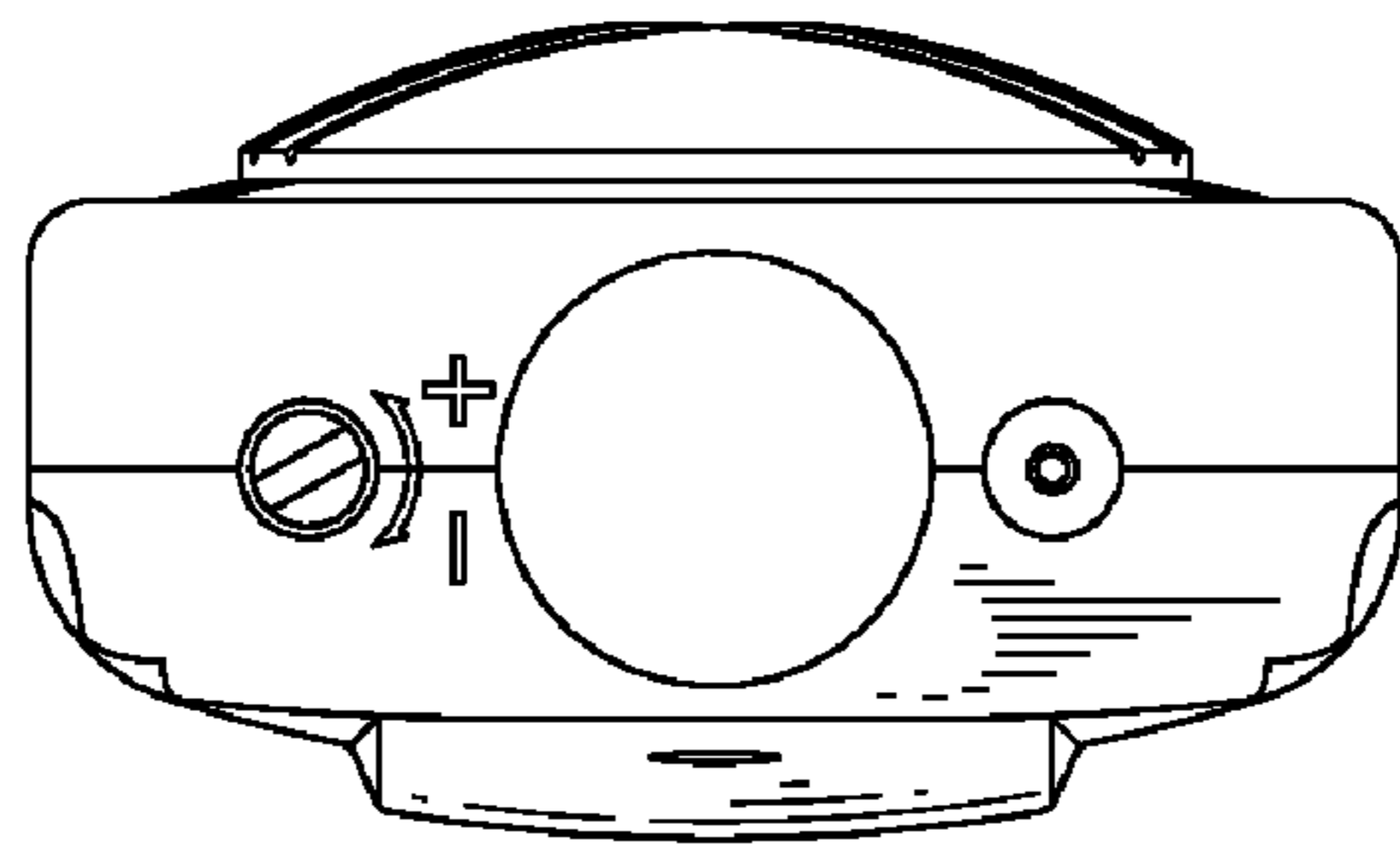

FIG. 7