

US00D592793S

(12) **United States Design Patent**
Chandler

(10) **Patent No.:** **US D592,793 S**

(45) **Date of Patent:** **** May 19, 2009**

(54) **HANGING LAMP SUPPORT**

(75) Inventor: **George Chandler**, Hubbardton, VT (US)

(73) Assignee: **Hubbardton Forge LLC**, Castleton, VT (US)

(**) Term: **14 Years**

(21) Appl. No.: **29/325,384**

(22) Filed: **Sep. 30, 2008**

(51) **LOC (9) Cl.** **26-03**

(52) **U.S. Cl.** **D26/88; D26/141**

(58) **Field of Classification Search** D26/75,
D26/76, 79, 81, 83, 84, 85, 88-91, 118, 138,
D26/141; 362/147, 404-408

See application file for complete search history.

(56) **References Cited**

U.S. PATENT DOCUMENTS

D42,583 S *	6/1912	Morgan	D26/81
D79,044 S *	7/1929	Ohm	D26/91
D79,241 S *	8/1929	Rosenblatt	D26/91
D84,764 S *	7/1931	Stange	D26/88
D430,331 S *	8/2000	Bleisch	D26/91
D468,475 S *	1/2003	De Lucchi	D26/90
D562,493 S *	2/2008	Chen	D26/88

OTHER PUBLICATIONS

George Kovacs Pendant #P388-084. Added to www.carolinarustica.com on Sep. 1, 2007.*

* cited by examiner

Primary Examiner—Clare E Heflin

(74) *Attorney, Agent, or Firm*—Bourque and Associates

(57) **CLAIM**

The ornamental design for a hanging lamp support, as shown and described.

DESCRIPTION

FIG. 1 is a perspective view of the hanging lamp support according to the present invention;

FIG. 2 is a left side elevation view thereof;

FIG. 3 is a right side elevation thereof;

FIG. 4 is a front elevation view thereof;

FIG. 5 is a rear elevation view thereof;

FIG. 6 is a top plan view thereof; and,

FIG. 7 is a bottom perspective view of the hanging lamp support thereof.

The broken lines shown are for illustrative purposes only and form no part of the claimed design.

1 Claim, 7 Drawing Sheets

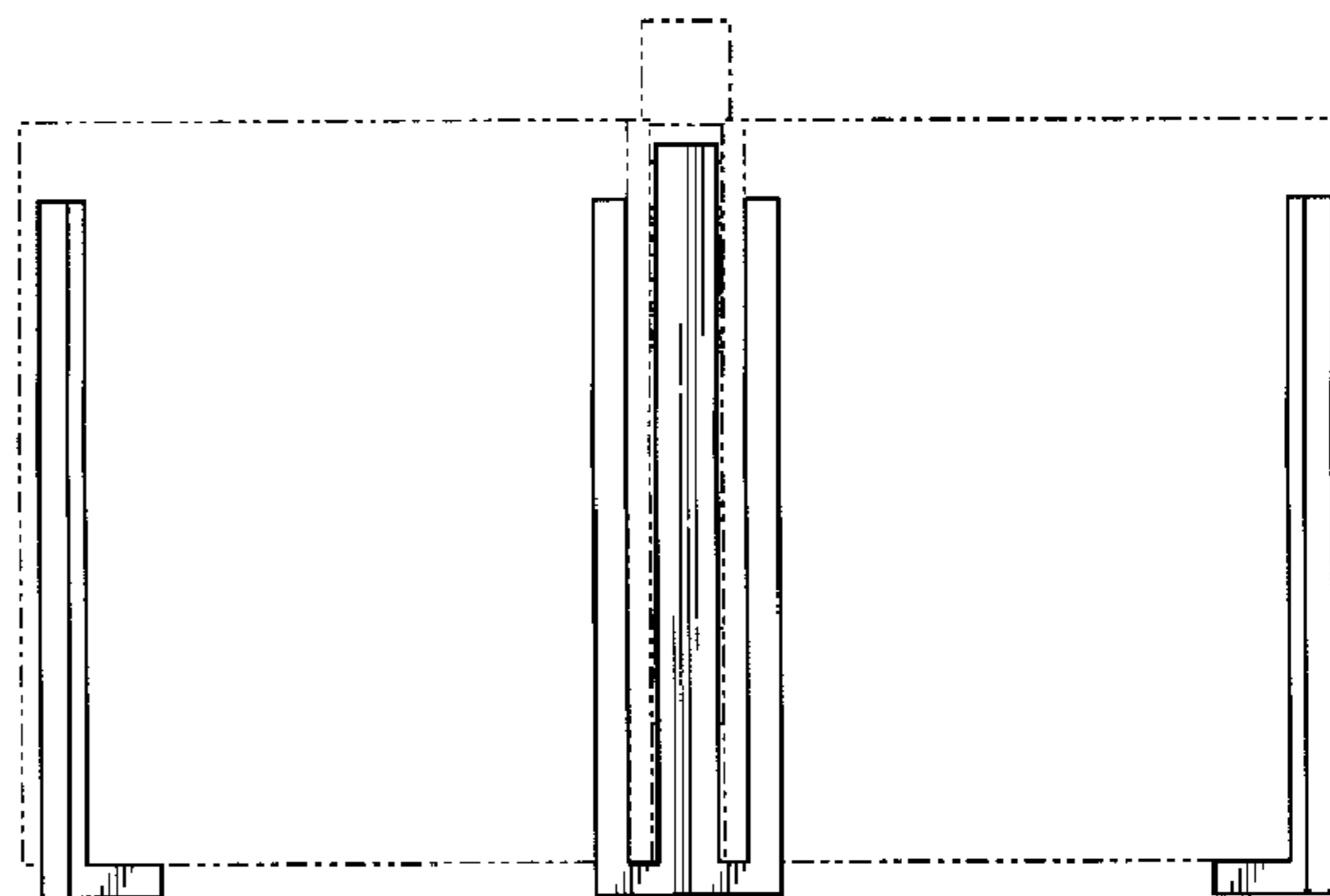
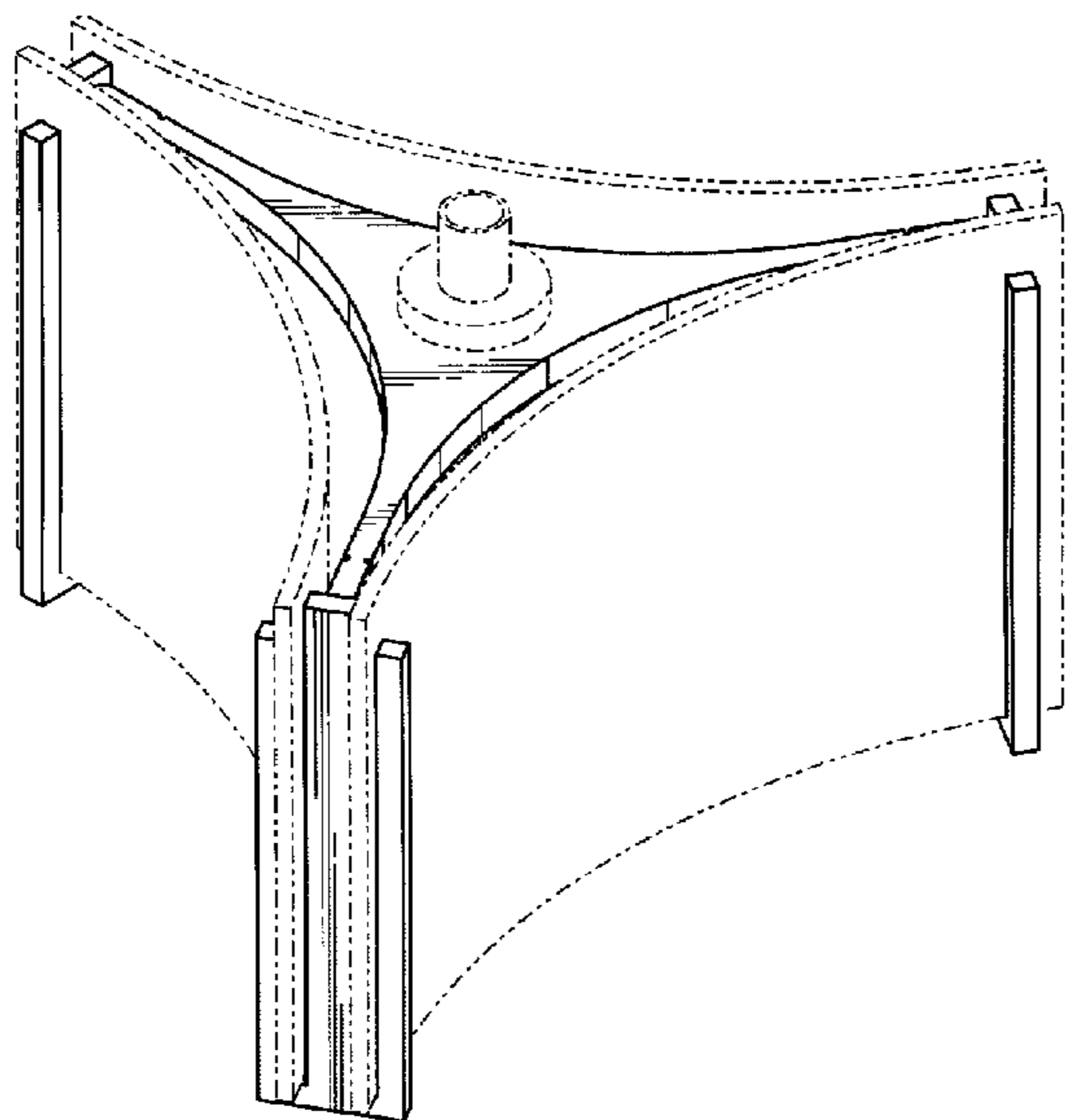

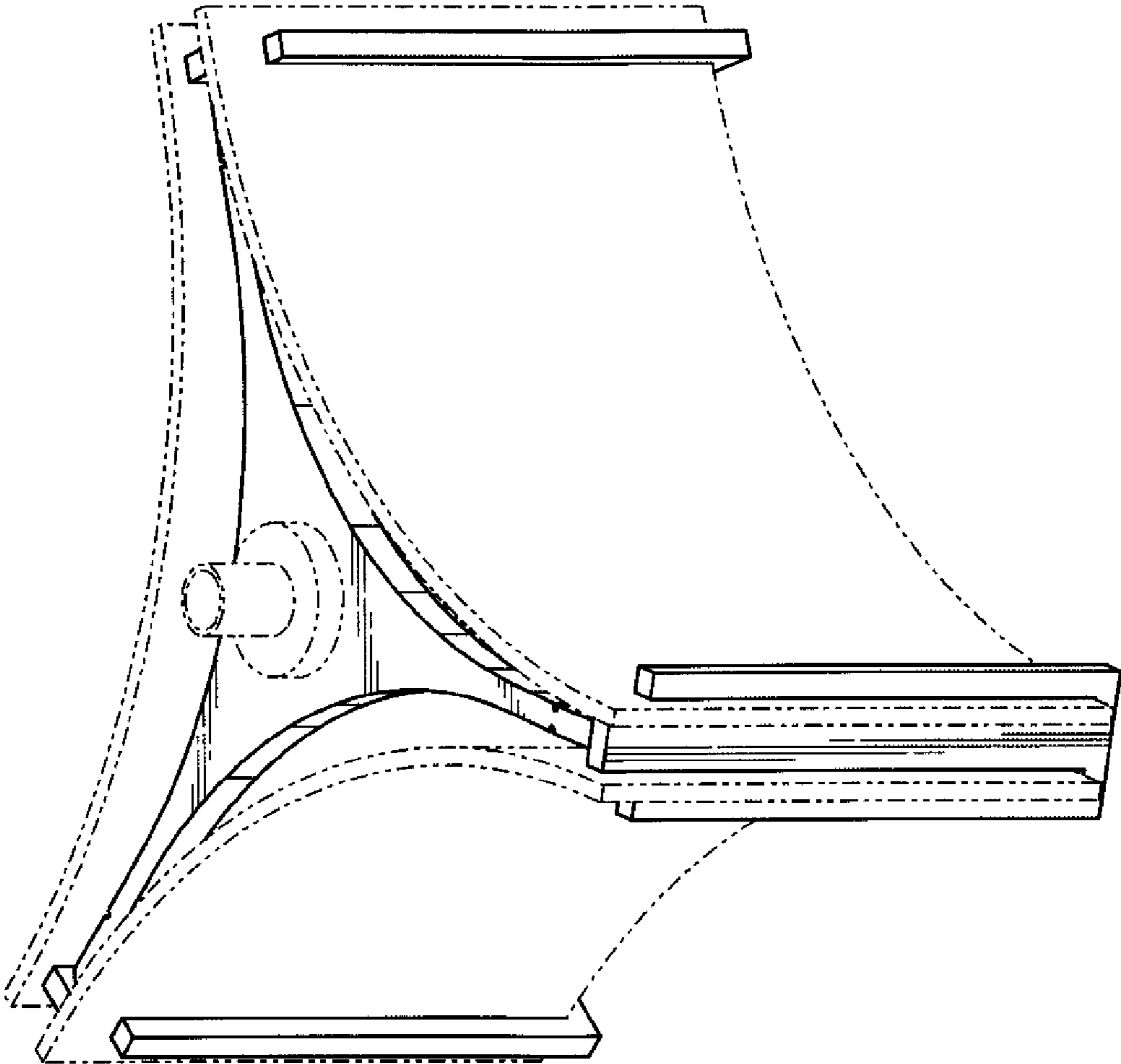

FIG. 1

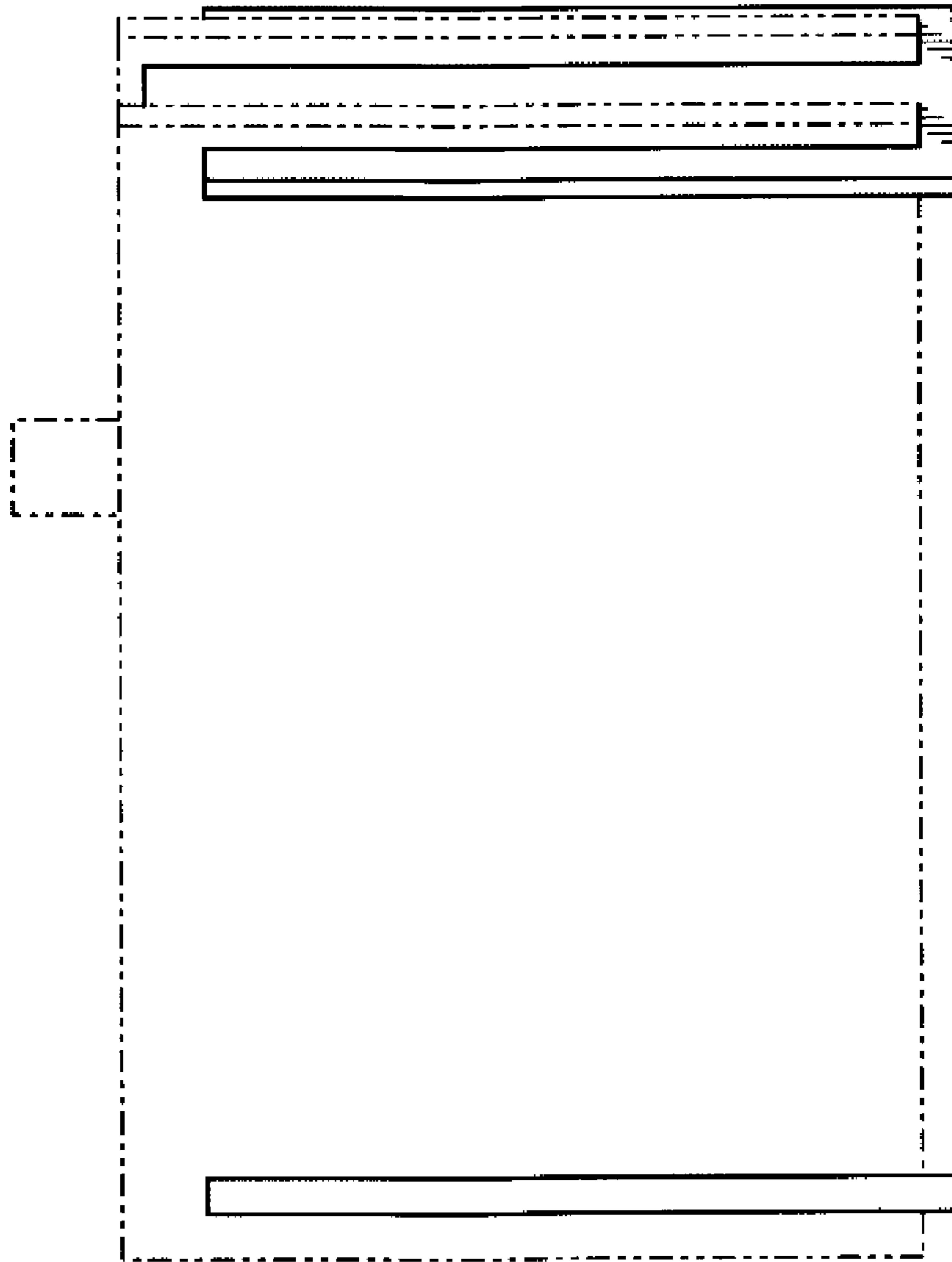

FIG. 2

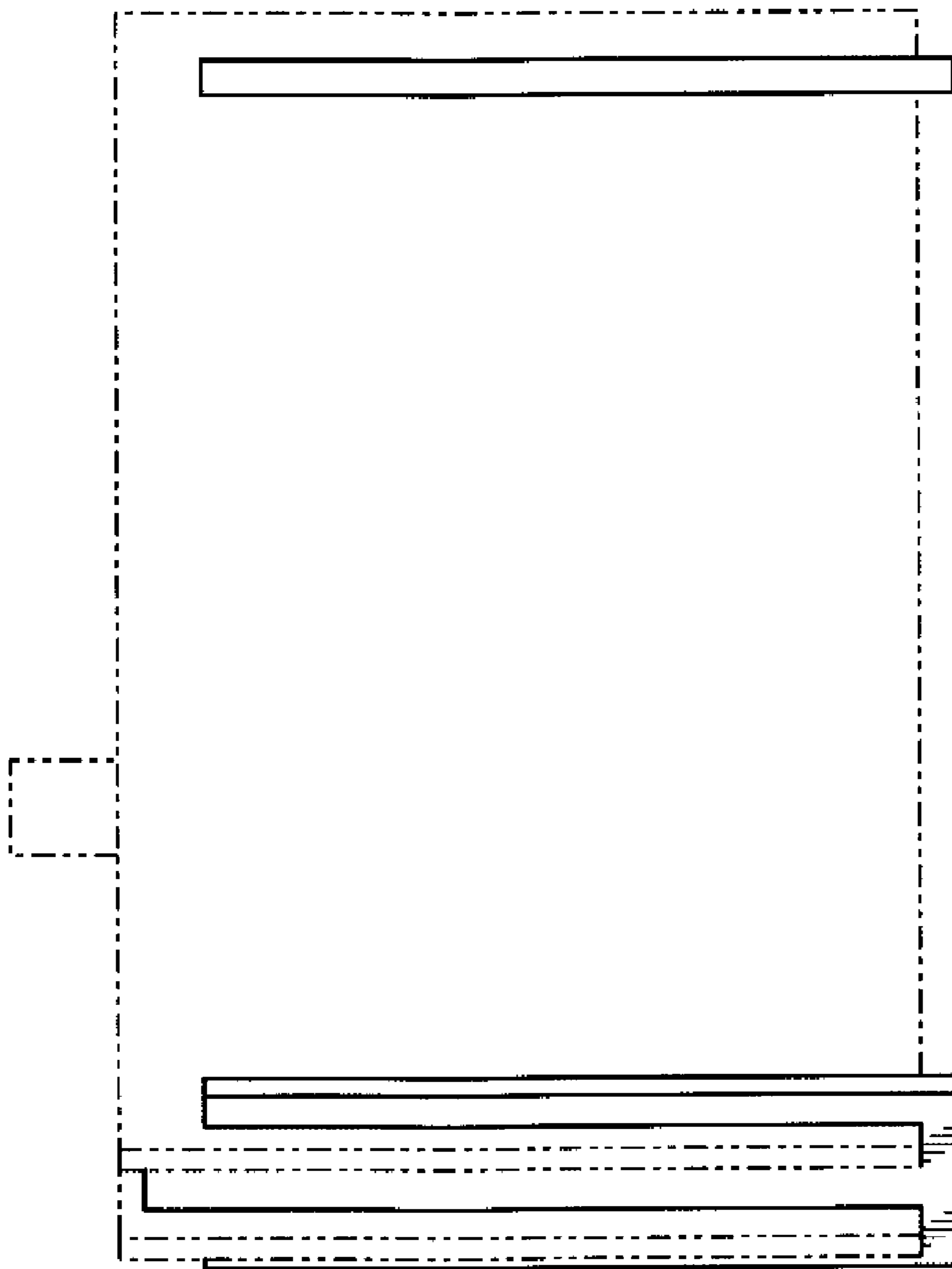

FIG. 3

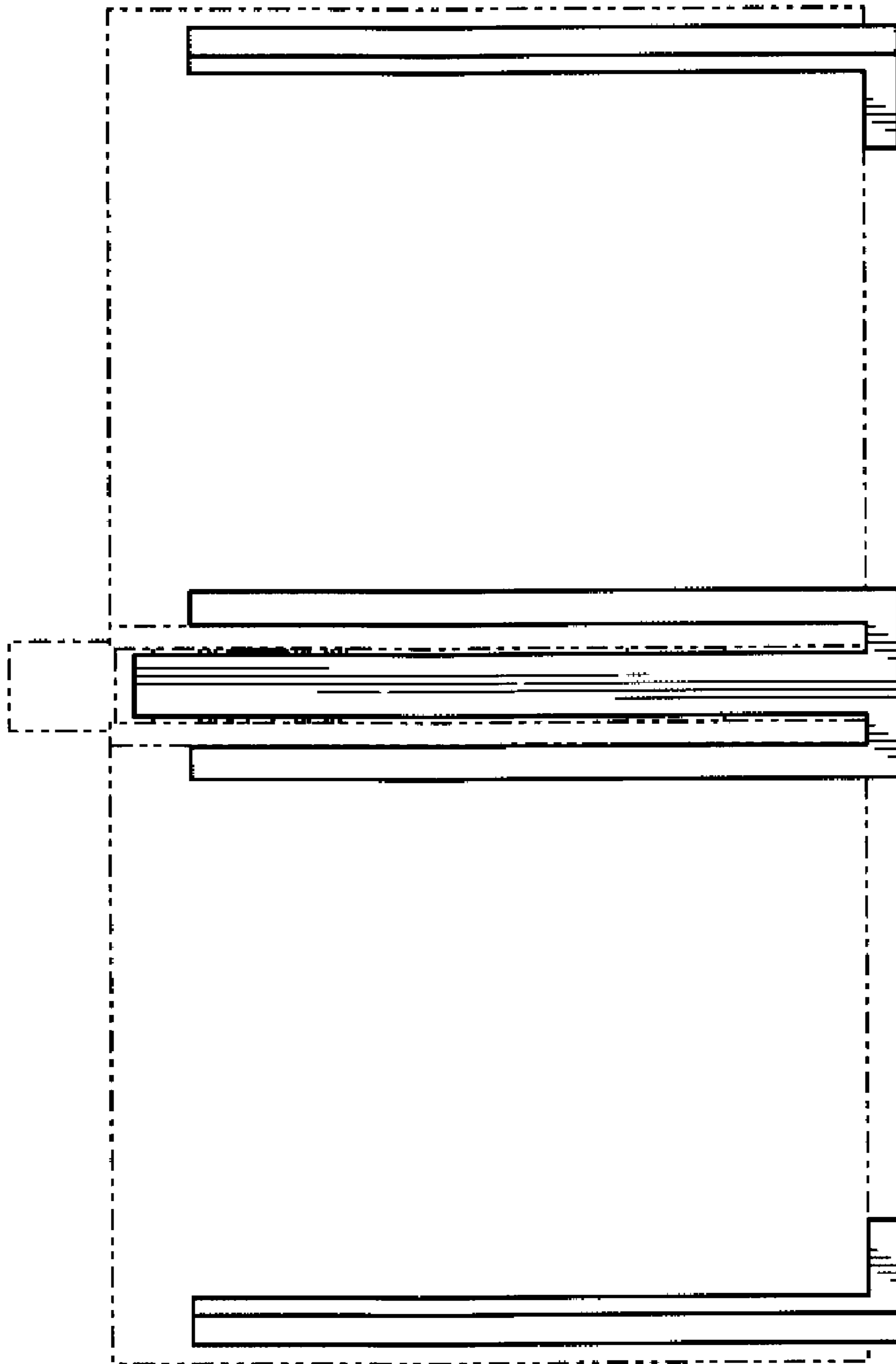

FIG. 4

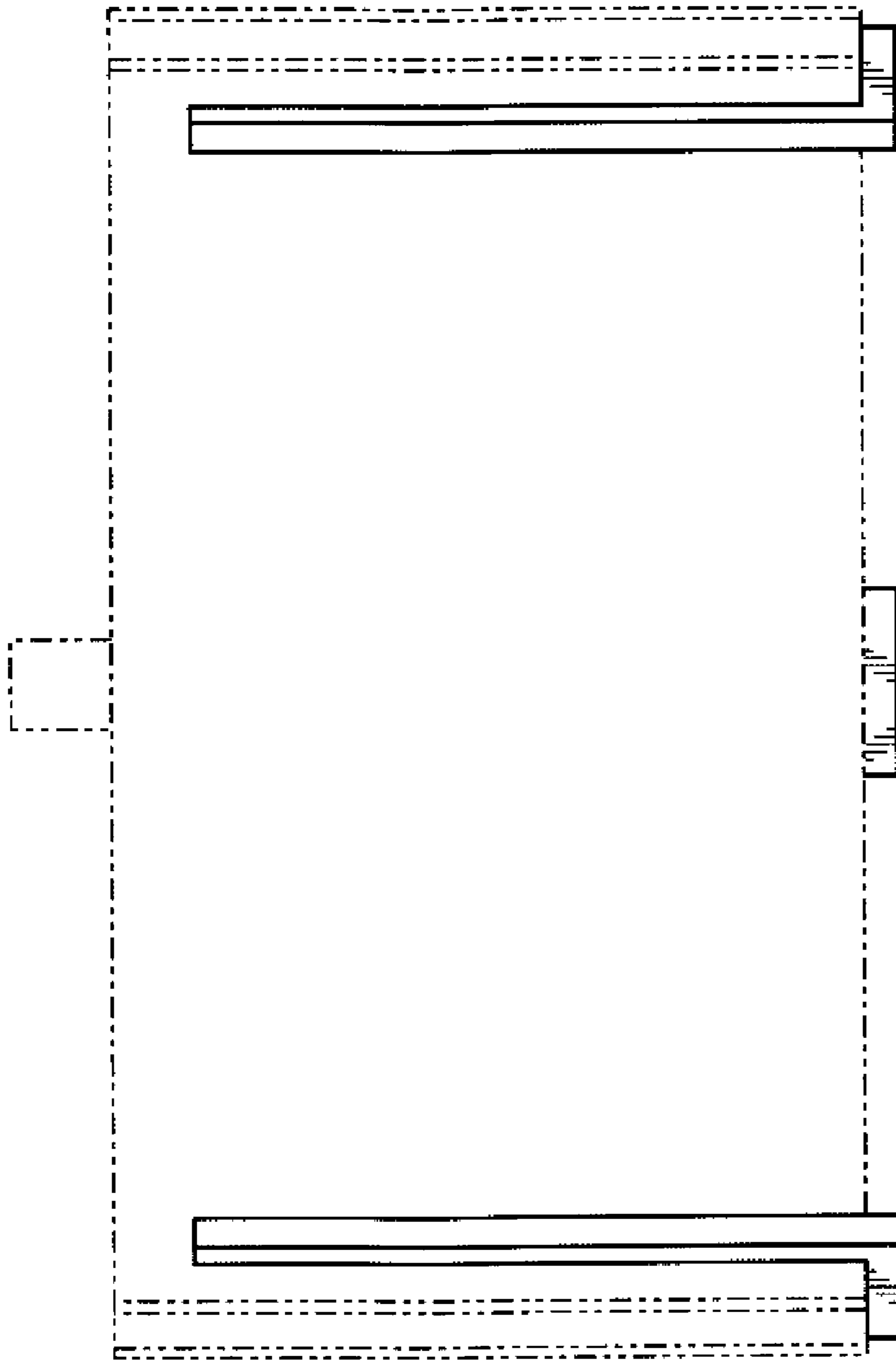

FIG. 5

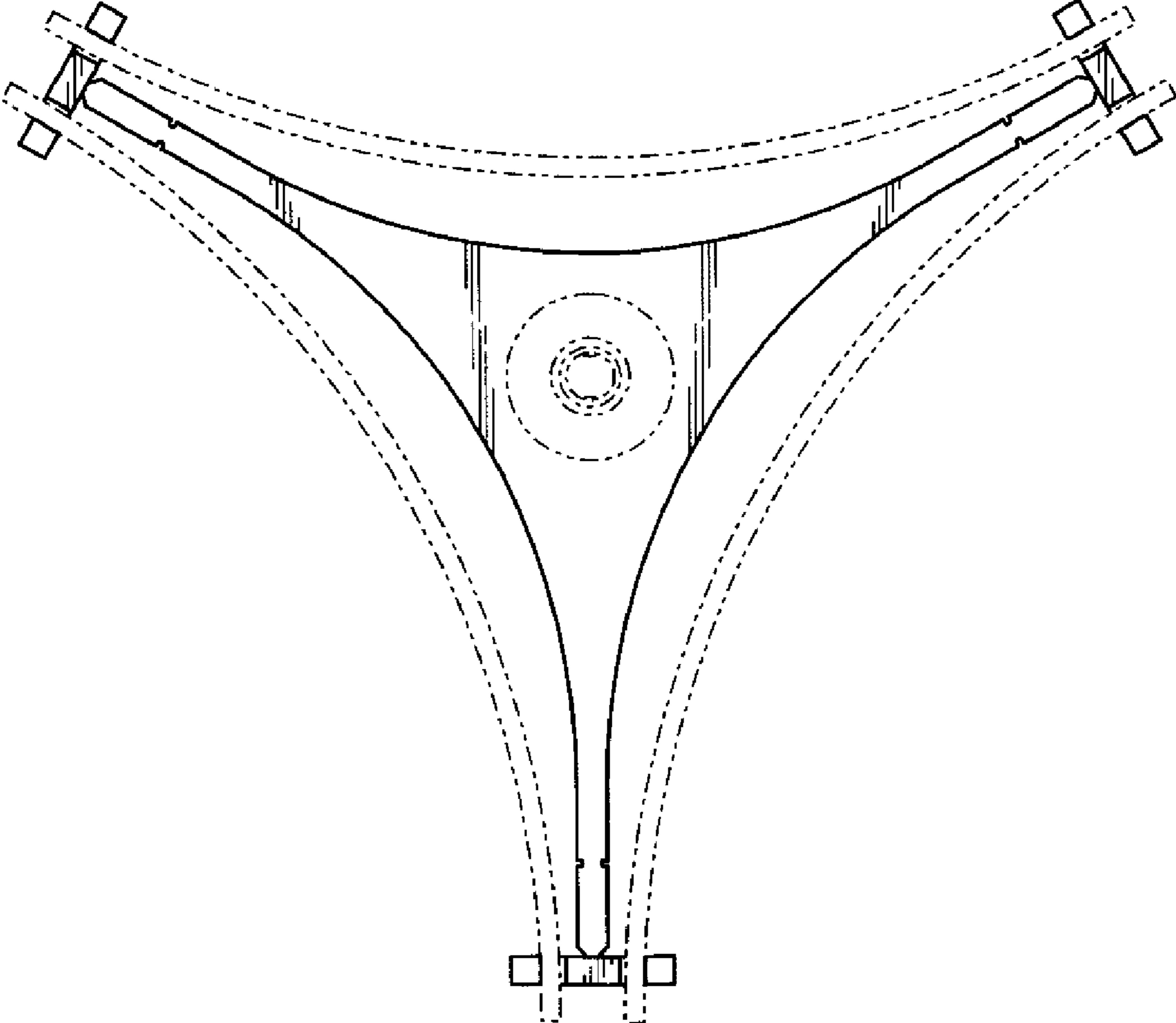

FIG. 6

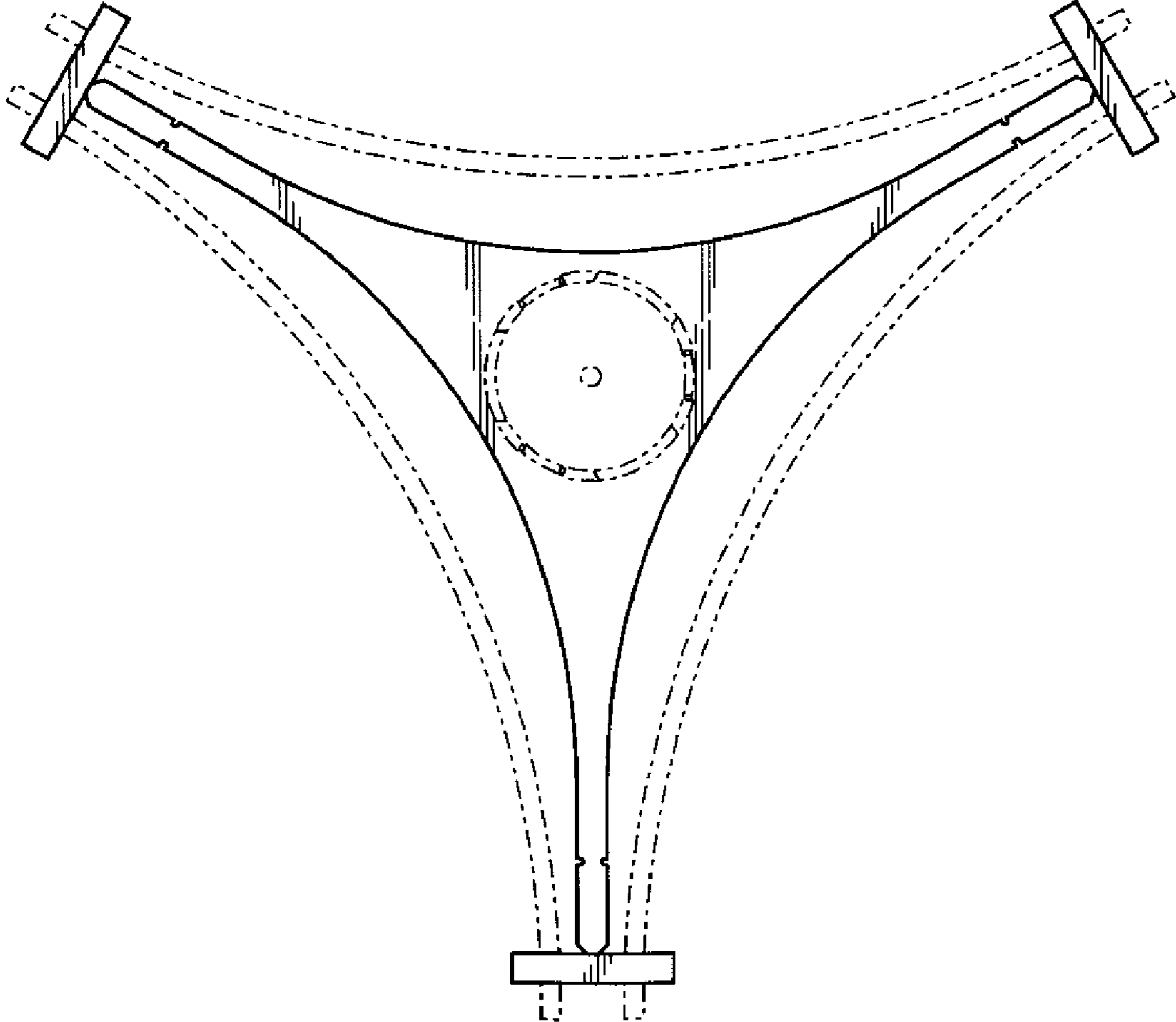

FIG. 7