



US00D592712S

(12) **United States Design Patent**  
**Sato et al.**

(10) **Patent No.:** **US D592,712 S**

(45) **Date of Patent:** **\*\* May 19, 2009**

(54) **TOY**

(75) Inventors: **Wataru Sato**, Kawasaki (JP); **Noriyoshi Matsumura**, Chiba (JP)

(73) Assignee: **Spin Master Ltd.**, Toronto, Ontario (CA)

(\*\*) Term: **14 Years**

(21) Appl. No.: **29/293,923**

(22) Filed: **Dec. 18, 2007**

(51) **LOC (9) Cl.** ..... **21-01**

(52) **U.S. Cl.** ..... **D21/584; D21/606**

(58) **Field of Classification Search** ..... D21/578–584, D21/606; 446/71–72, 97, 99, 487  
See application file for complete search history.

(56) **References Cited**

**U.S. PATENT DOCUMENTS**

D272,458 S	1/1984	Fleminger
D286,800 S	11/1986	Maruyama
D287,258 S	12/1986	Maruyama
D292,110 S	9/1987	Tamakoshi
D296,916 S	7/1988	Matsuda
D297,749 S	9/1988	Rodis-Jamero
D298,150 S	10/1988	Torres et al.
D298,151 S	10/1988	Torres et al.

*Primary Examiner*—Sandra Morris

(74) *Attorney, Agent, or Firm*—Cohen Pontani Lieberman & Pavane LLP

(57) **CLAIM**

The ornamental design for a toy, as shown and described.

**DESCRIPTION**

FIG. 1 is a front perspective view showing the toy in the opened state;

FIG. 2 is a rear perspective view thereof;

FIG. 3 is a top view thereof;

FIG. 4 is a bottom view thereof;

FIG. 5 is a front view thereof;

FIG. 6 is a rear view thereof;

FIG. 7 is a left side view thereof;

FIG. 8 is a right side view thereof;

FIG. 9 is a front, perspective view of the toy in the closed state;

FIG. 10 is a top view thereof;

FIG. 11 is a bottom view thereof;

FIG. 12 is a front view thereof;

FIG. 13 is a rear view thereof;

FIG. 14 is a left side view thereof; and,

FIG. 15 is a right side view thereof.

**1 Claim, 9 Drawing Sheets**

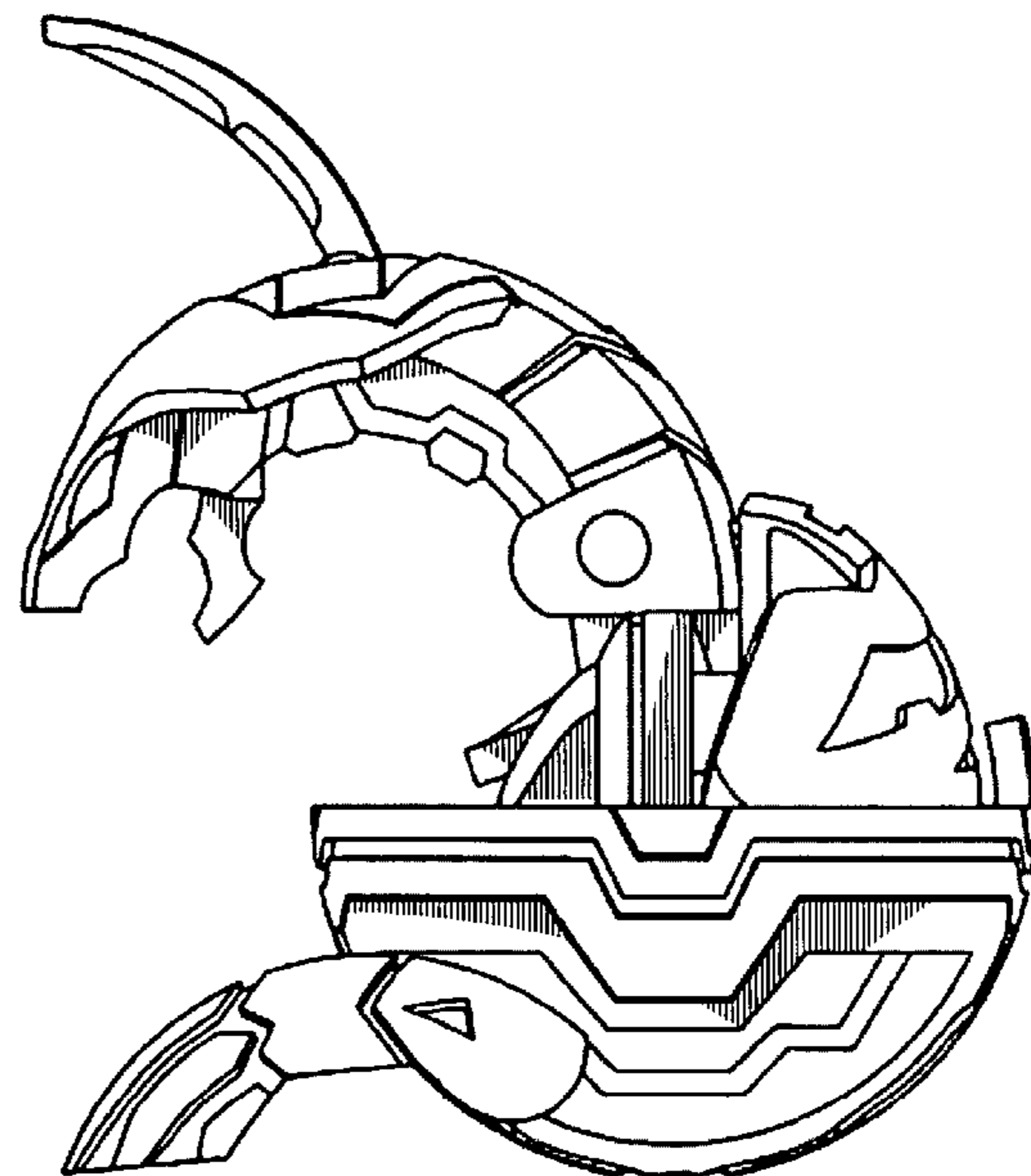
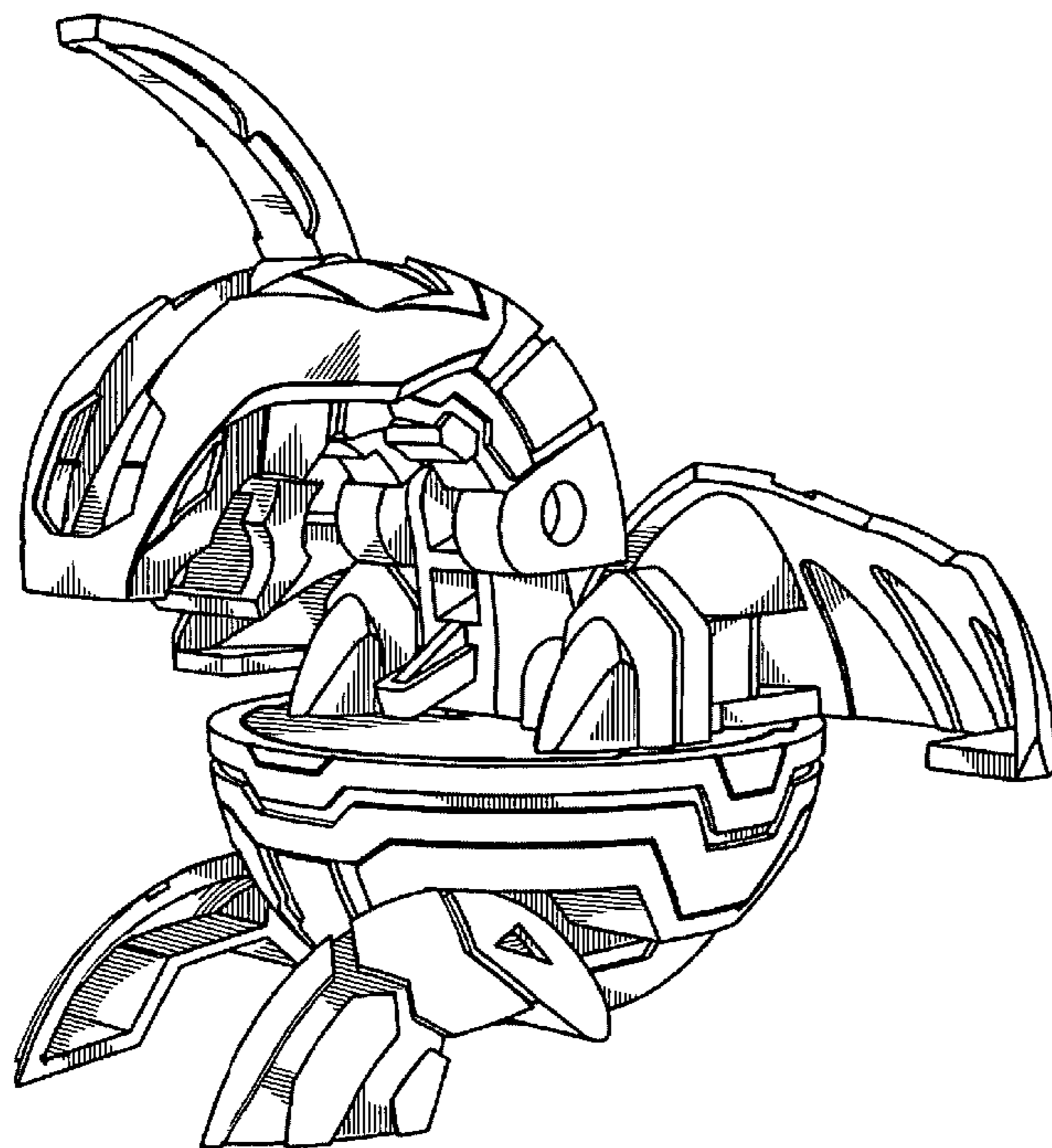

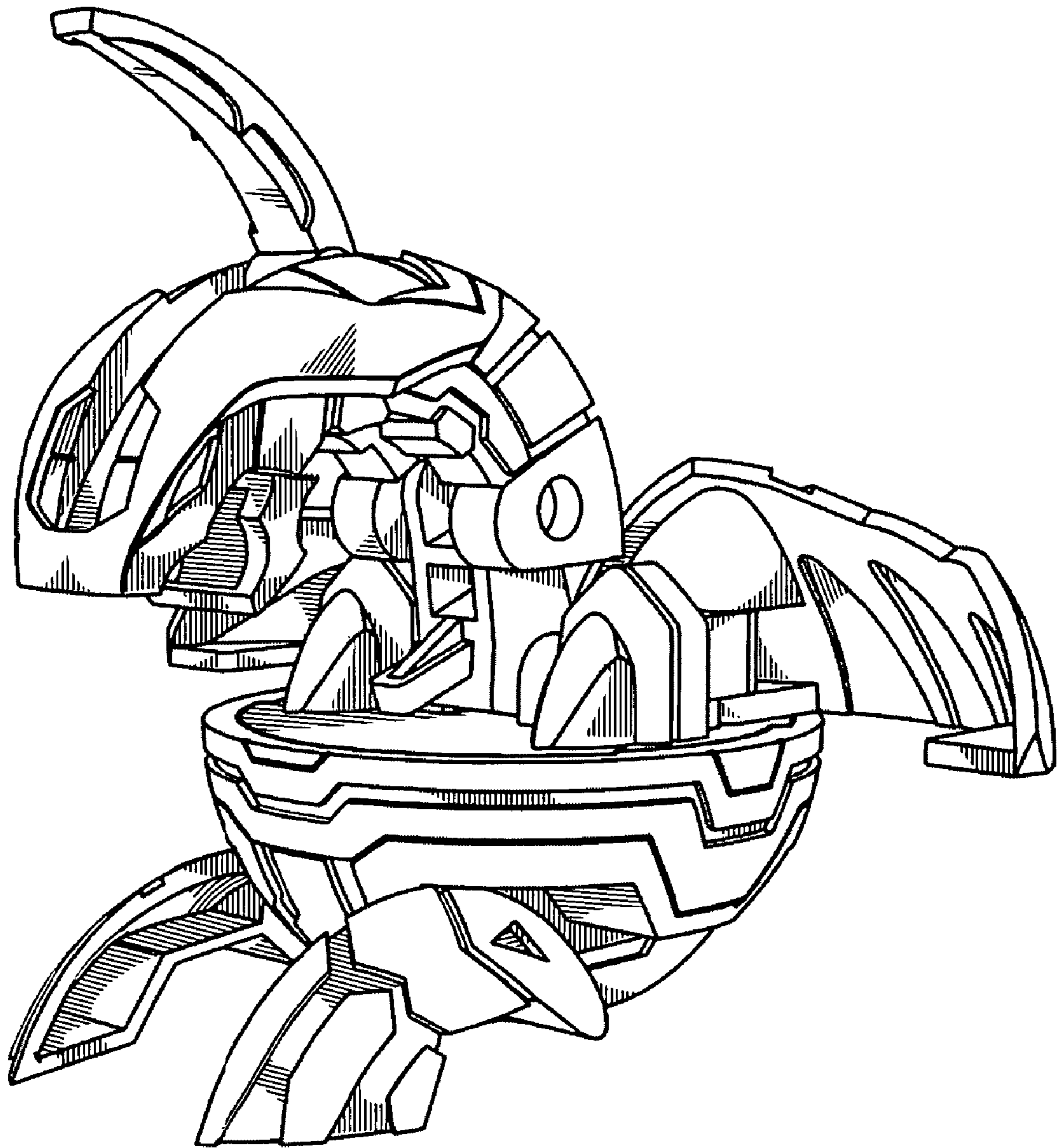

**Fig. 1**



**Fig. 2**



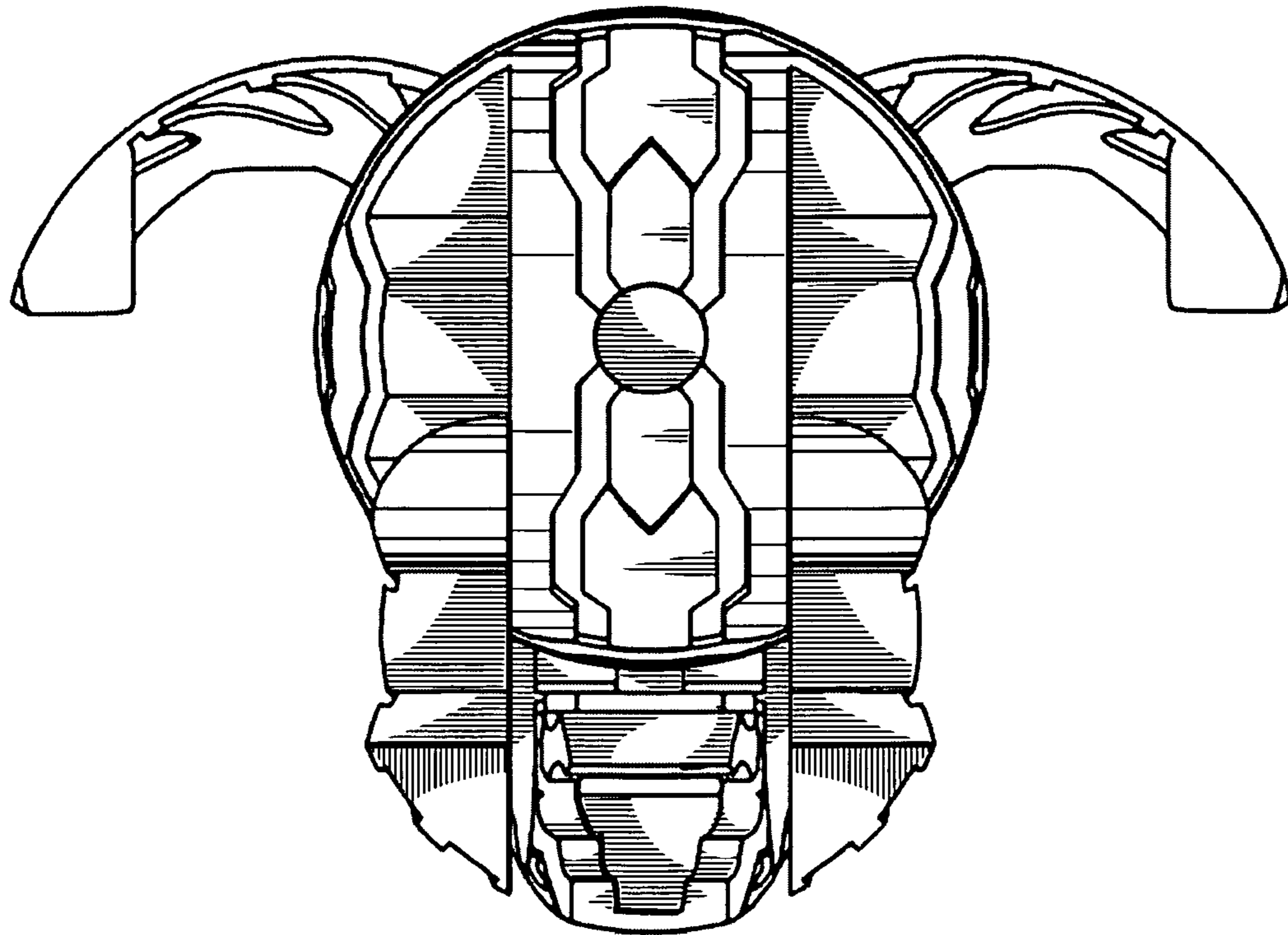

Fig. 4

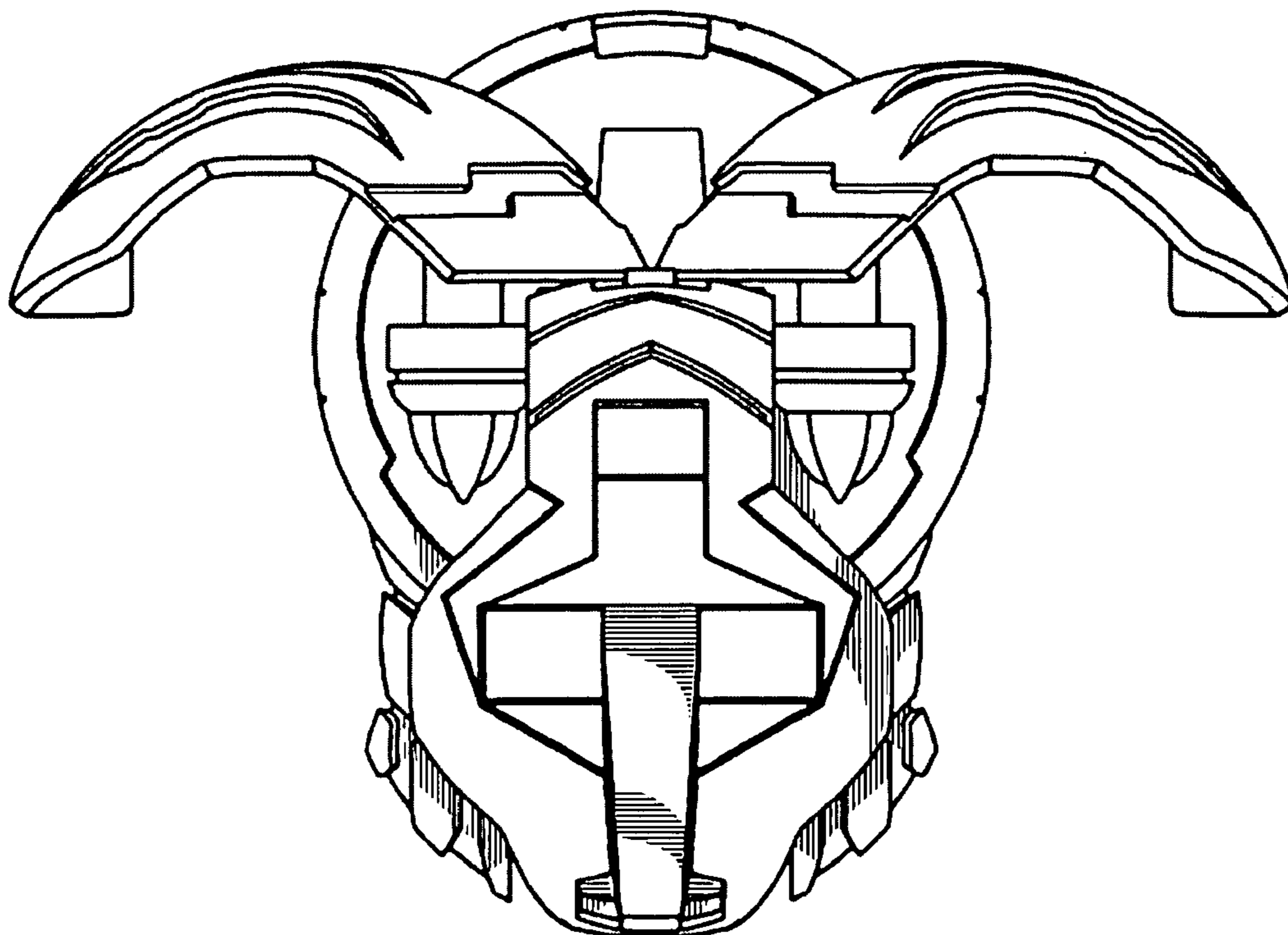
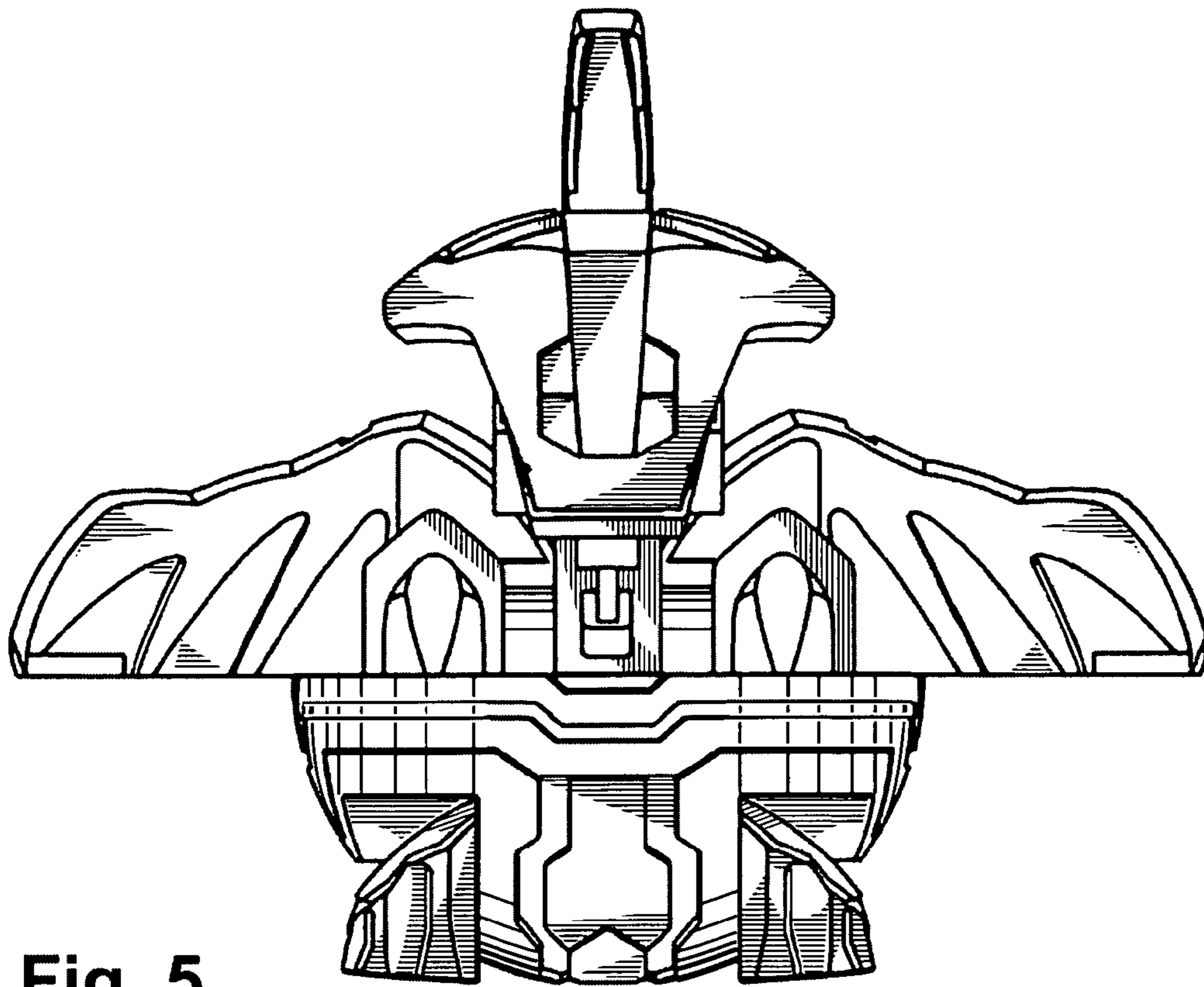
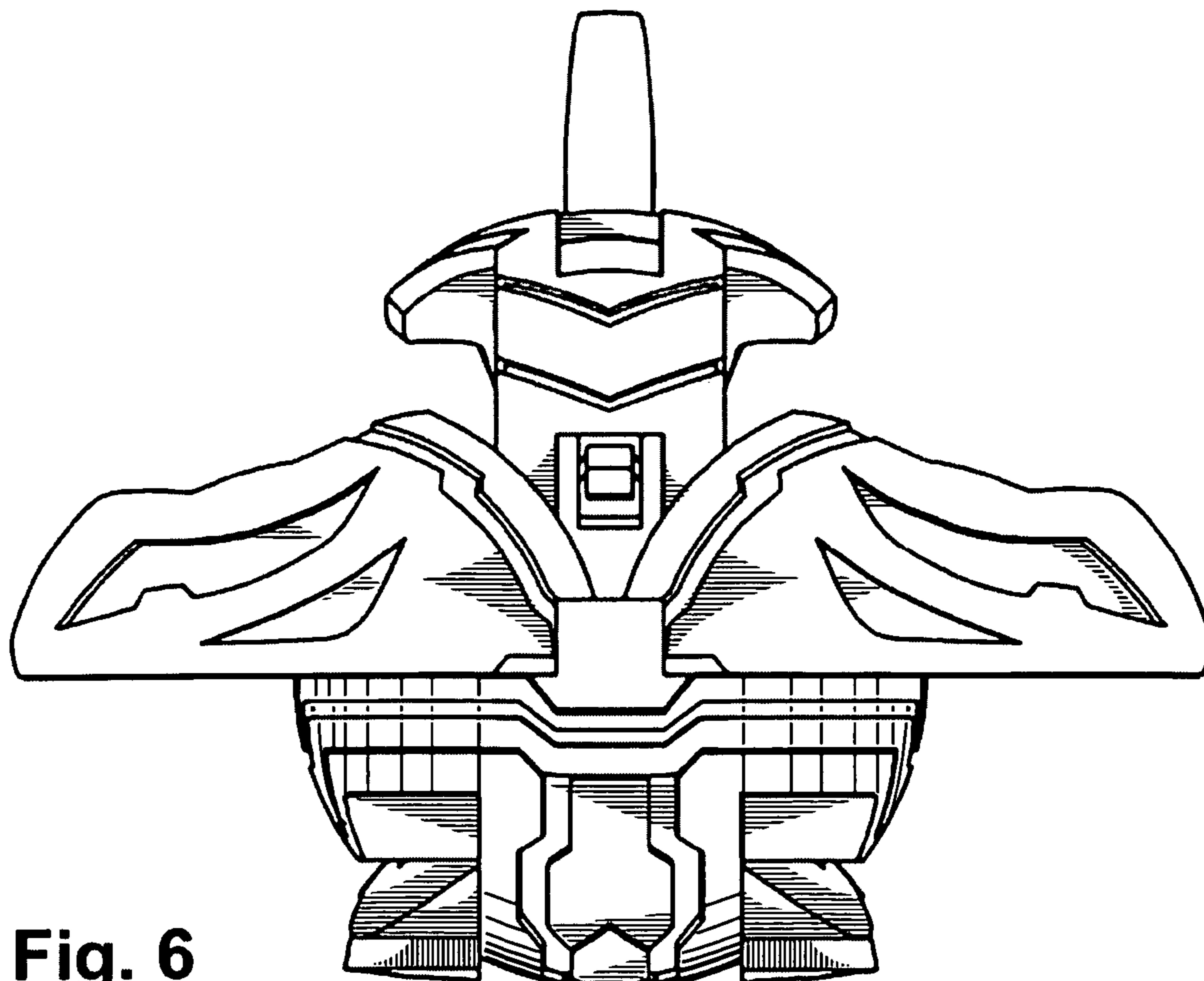

Fig. 3



**Fig. 5**



**Fig. 6**

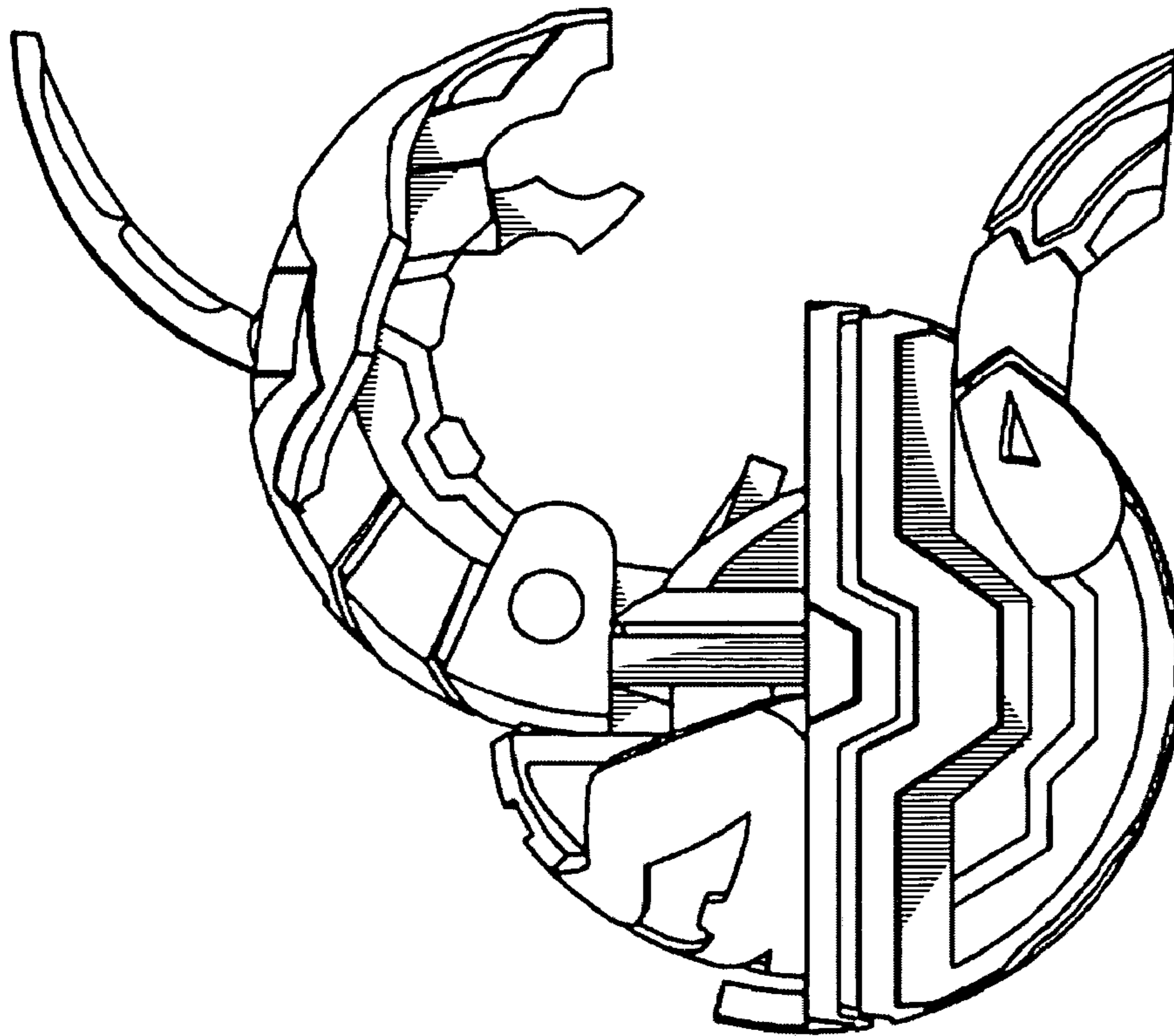

Fig. 8

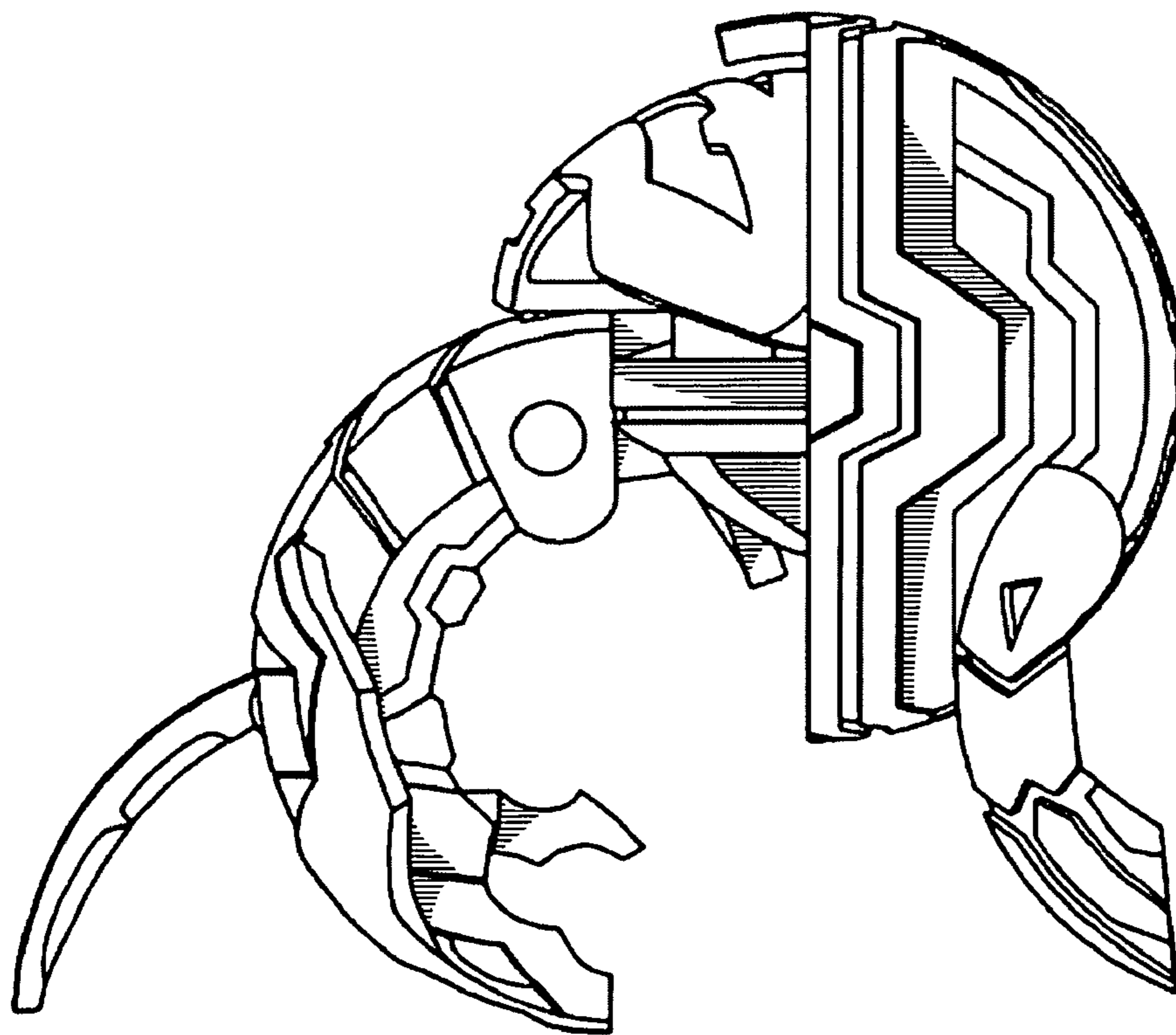
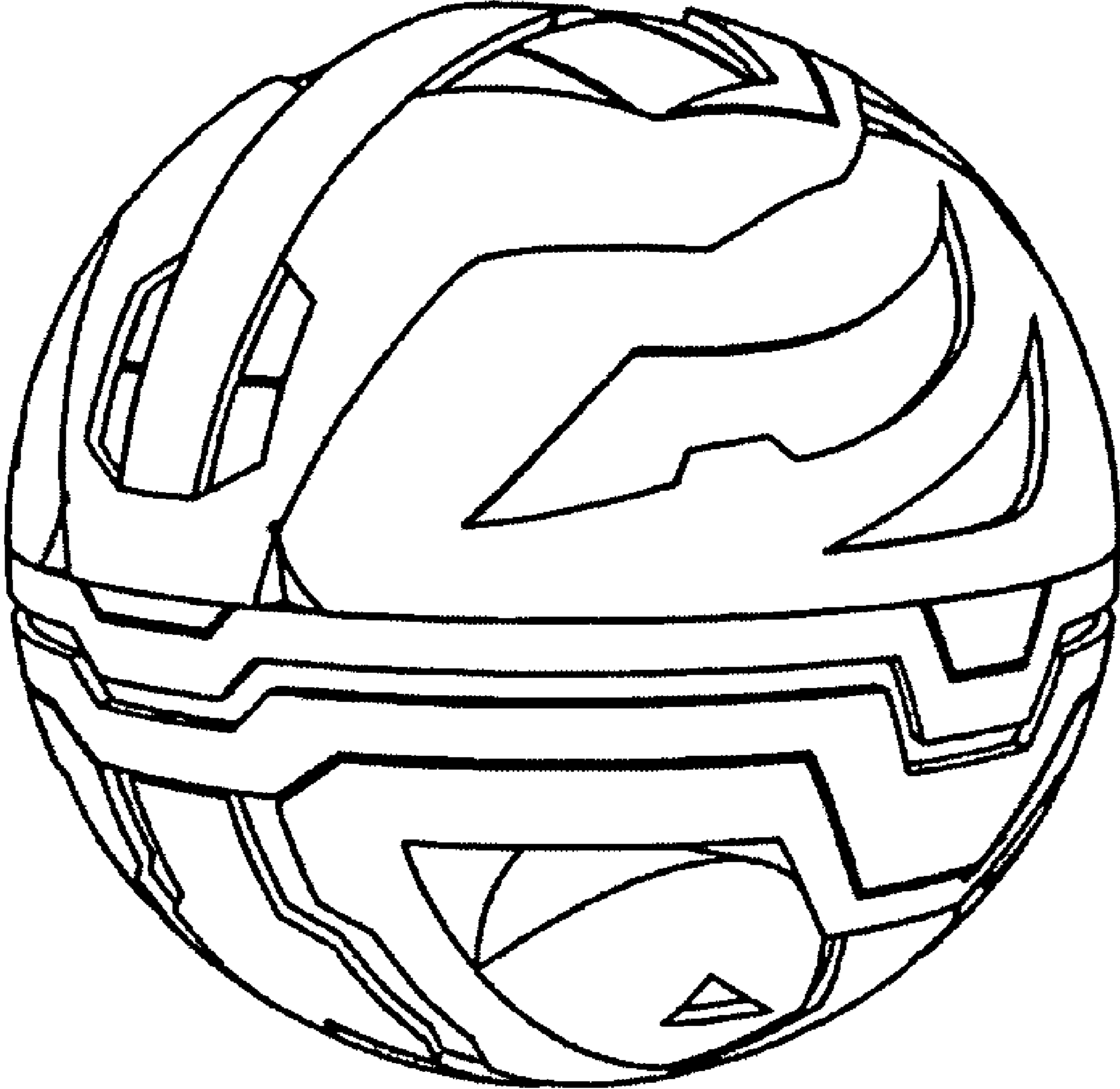
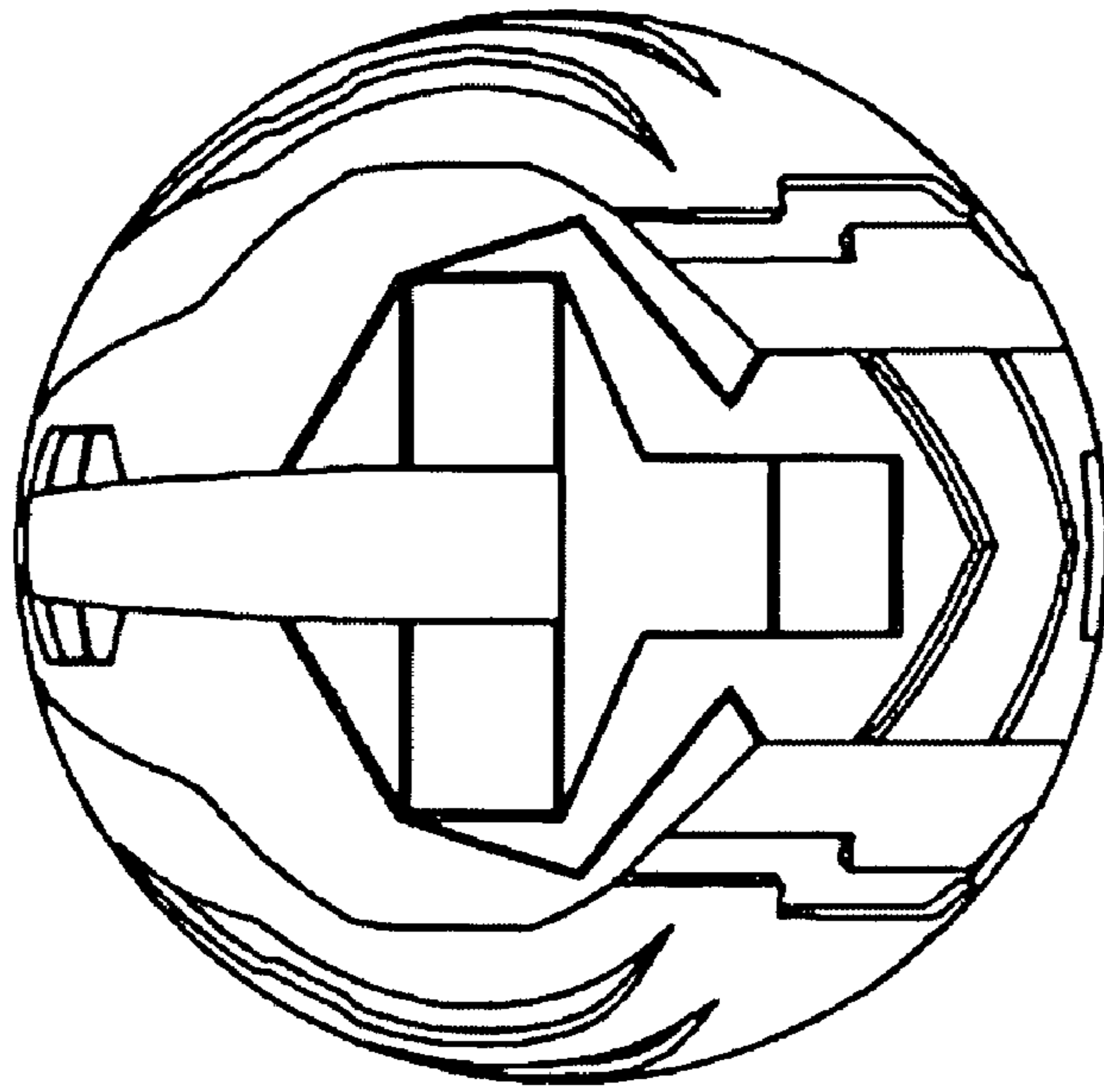

Fig. 7

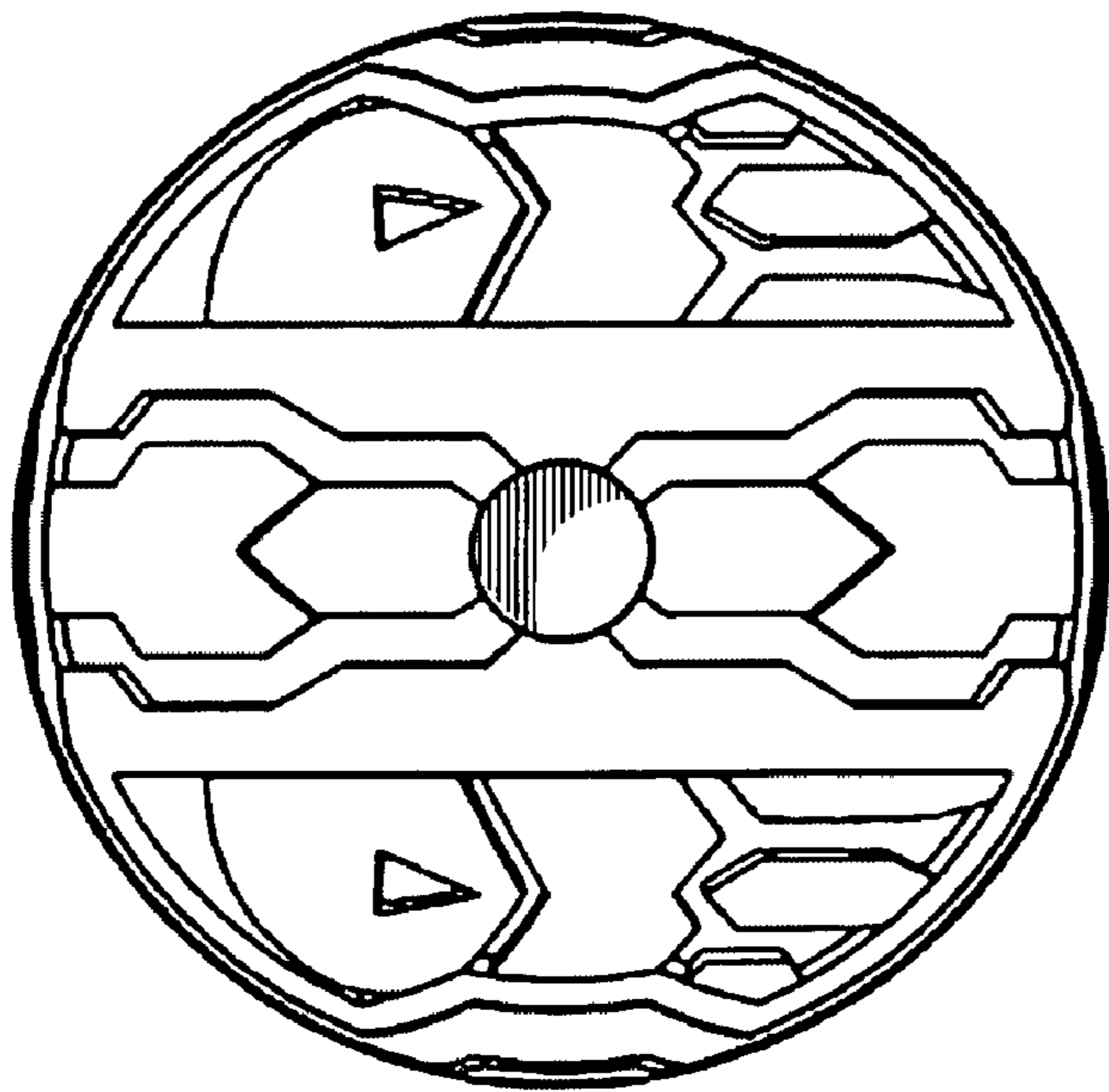

**Fig. 9**



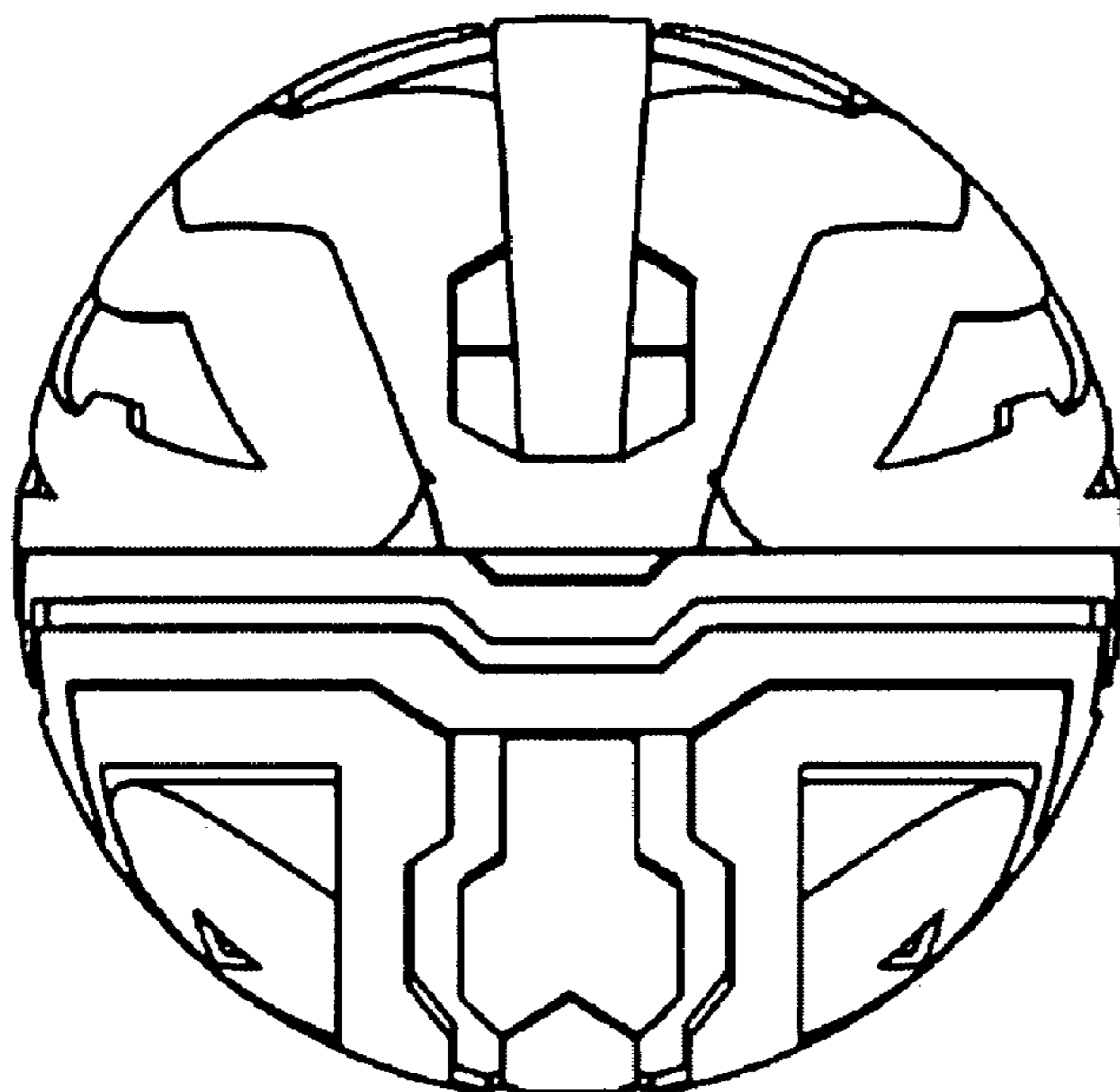

**Fig. 10**

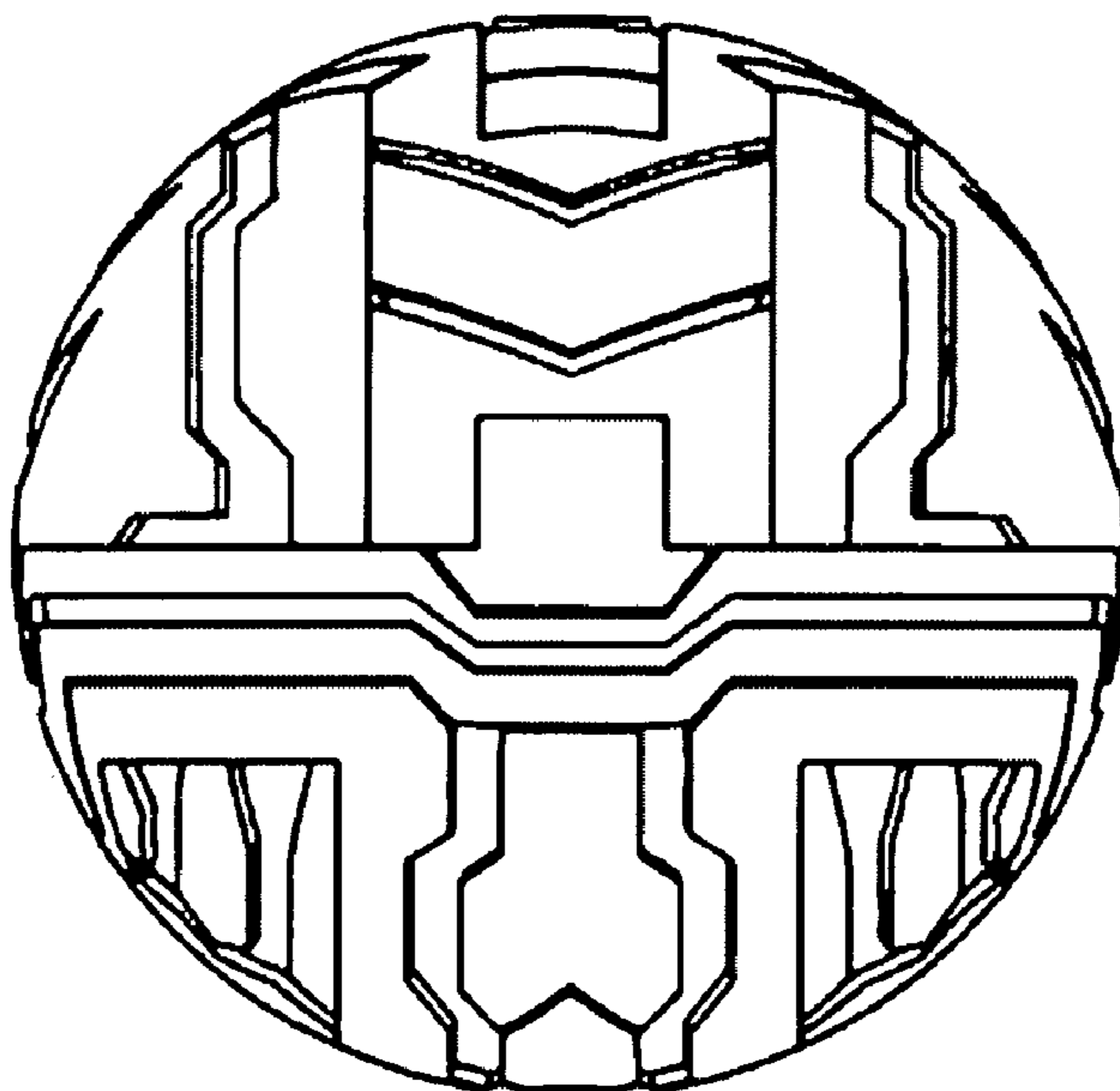

**Fig. 11**





**Fig. 12**



**Fig. 13**



**Fig. 14**

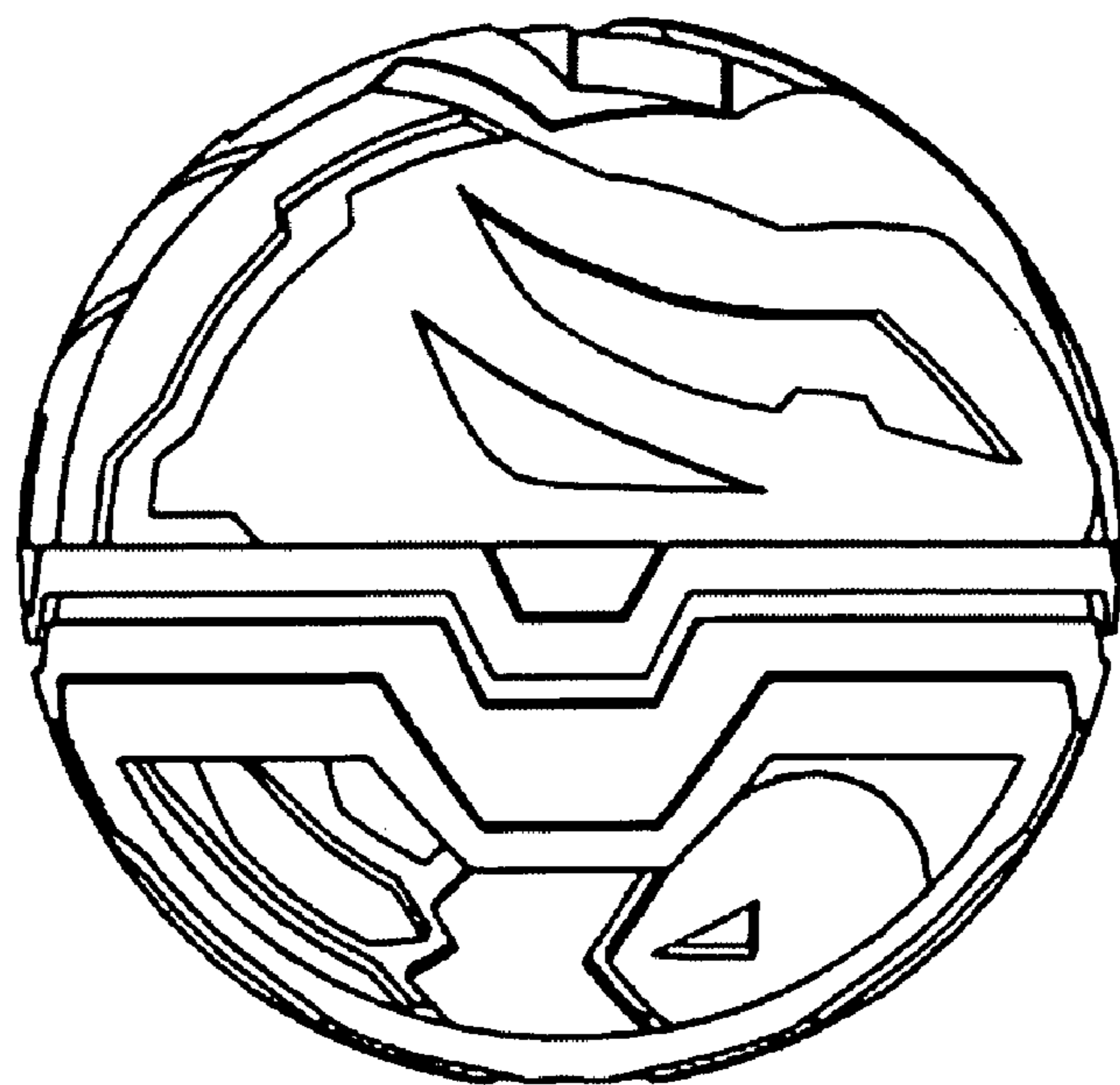

**Fig. 15**