



US00D592645S

(12) **United States Design Patent**
Motoishi

(10) **Patent No.:** **US D592,645 S**

(45) **Date of Patent:** **** May 19, 2009**

(54) **SPEAKER BOX**

(75) Inventor: **Takuya Motoishi**, Tokyo (JP)

(73) Assignee: **Sony Corporation**, Tokyo (JP)

(**) Term: **14 Years**

(21) Appl. No.: **29/309,195**

(22) Filed: **Jul. 7, 2008**

(30) **Foreign Application Priority Data**

Jan. 14, 2008 (CN) 2008 3 0001659

(51) **LOC (9) Cl.** **14-01**

(52) **U.S. Cl.** **D14/215**

(58) **Field of Classification Search** D14/204,
D14/210-216, 172; 181/143-144, 147-148,
181/150-153, 157, 198-199; 381/300-303,
381/306, 332-333, 336, 345, 361-364, 386-388
See application file for complete search history.

(56) **References Cited**

U.S. PATENT DOCUMENTS

D268,673 S * 4/1983 Iijima D14/214
D467,572 S 12/2002 Narita

D470,474 S 2/2003 Kobayashi
D497,900 S * 11/2004 Motoishi D14/215
D506,746 S 6/2005 Hioki
D519,105 S 4/2006 Masui
D542,275 S 5/2007 Hibino

* cited by examiner

Primary Examiner—Nanda Bondade

(74) *Attorney, Agent, or Firm*—Rader, Fishman & Grauer, PLLC

(57) **CLAIM**

The ornamental design for a speaker box, as shown.

DESCRIPTION

FIG. 1 is a perspective view of a speaker box showing my new design;

FIG. 2 is a front elevational view thereof;

FIG. 3 is a rear elevational view thereof;

FIG. 4 is a left side elevational view thereof;

FIG. 5 is a right side elevational view thereof;

FIG. 6 is a top plan view thereof; and,

FIG. 7 is a bottom plan view thereof.

1 Claim, 7 Drawing Sheets

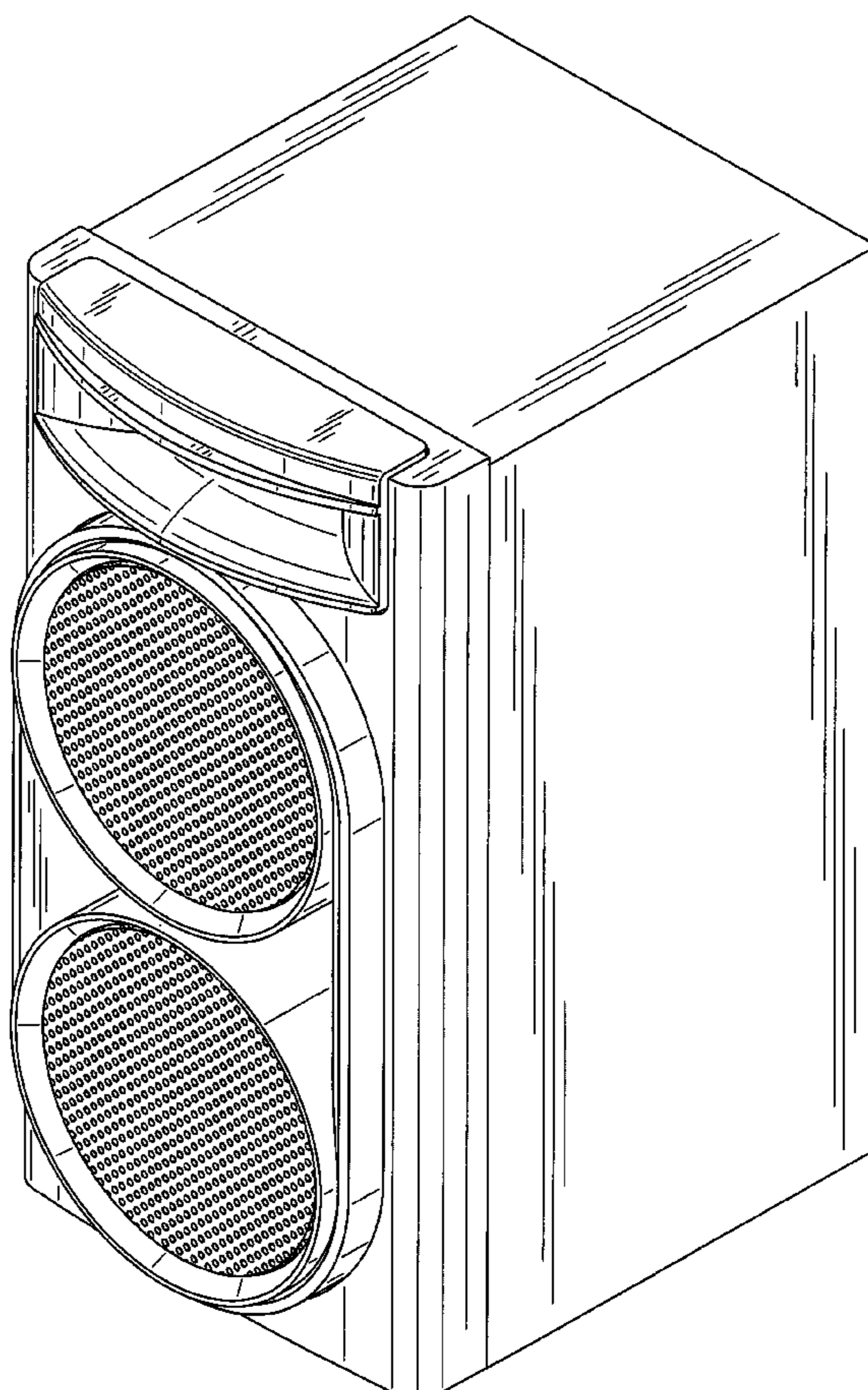

FIG.1

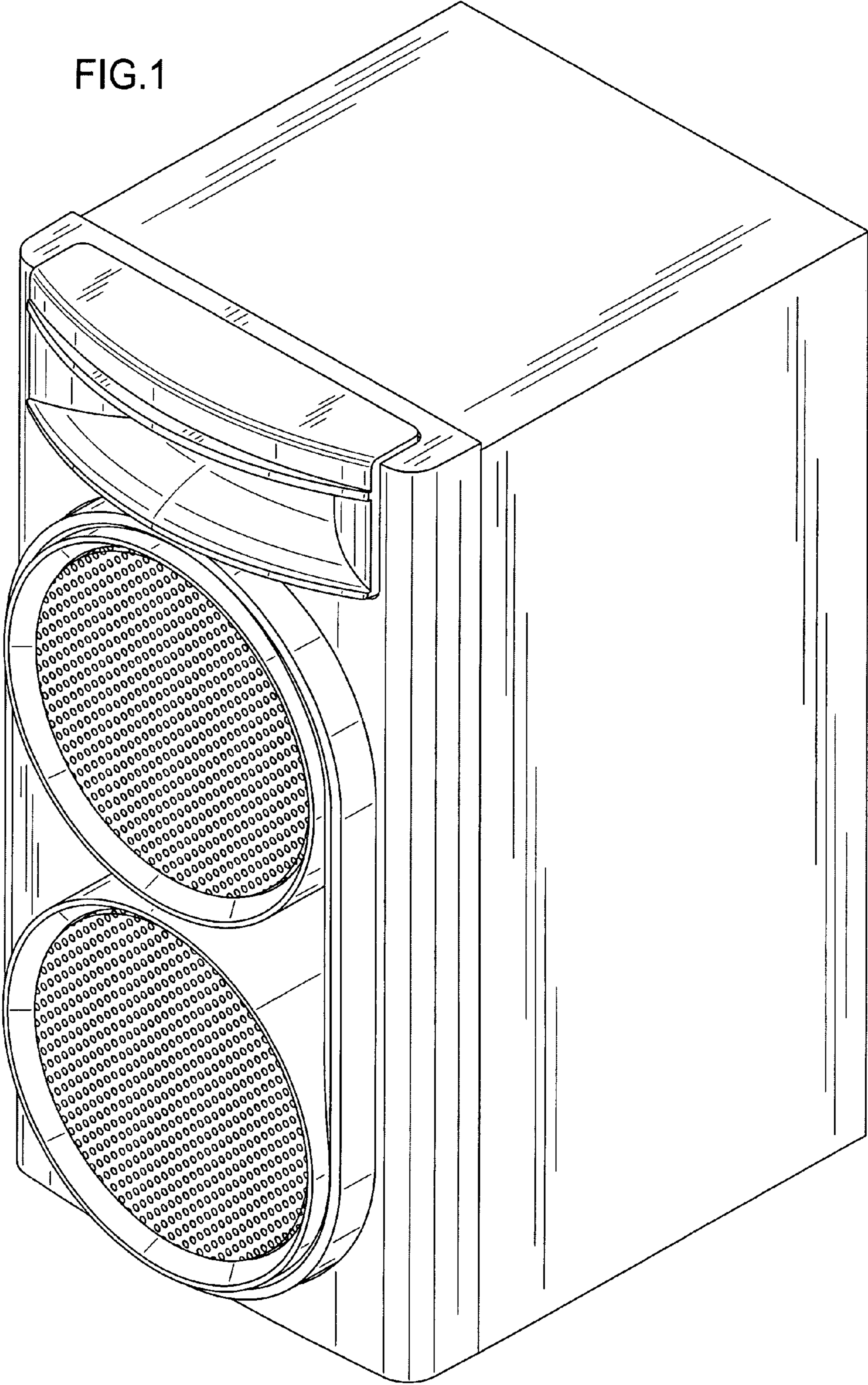

FIG.2

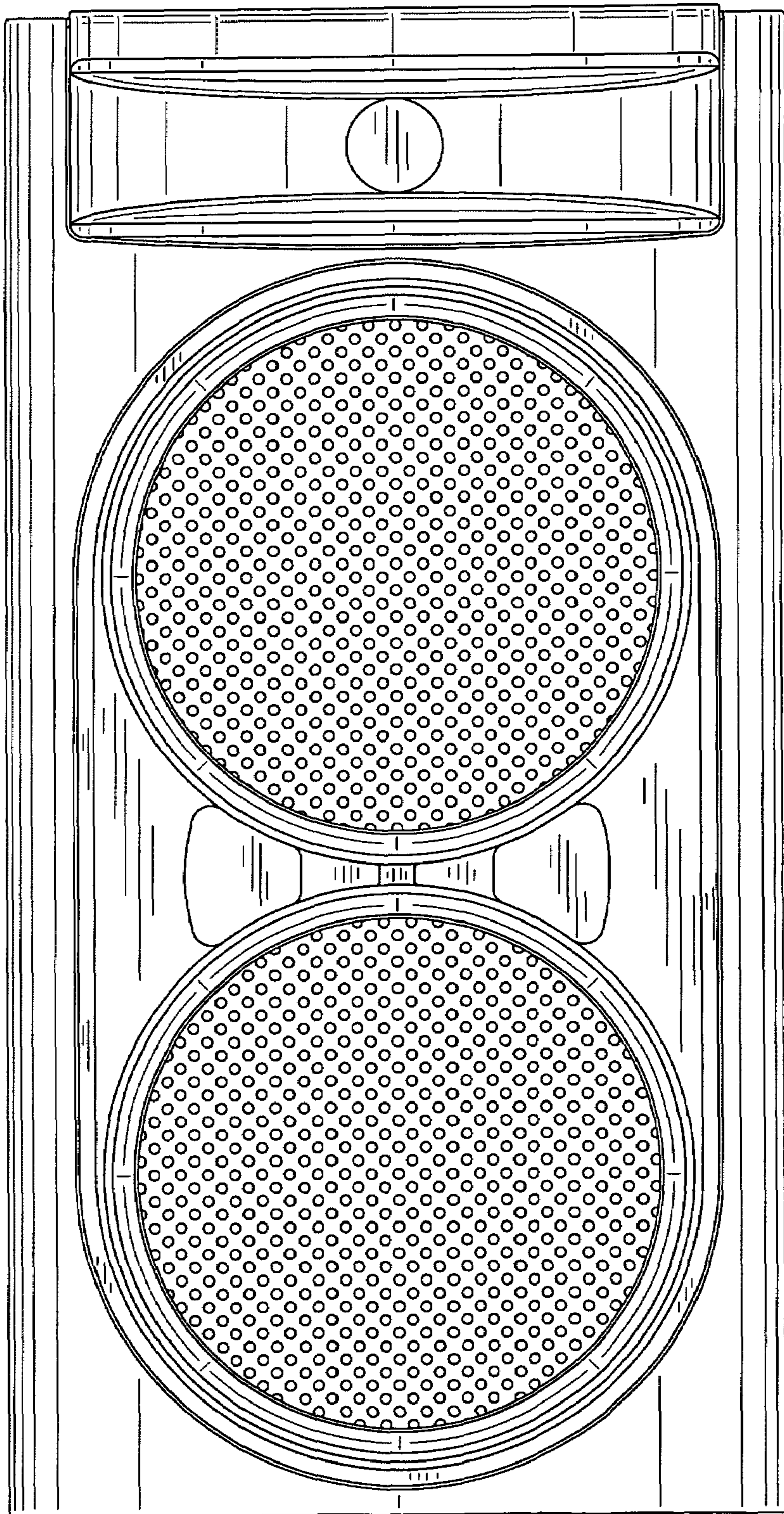

FIG.3

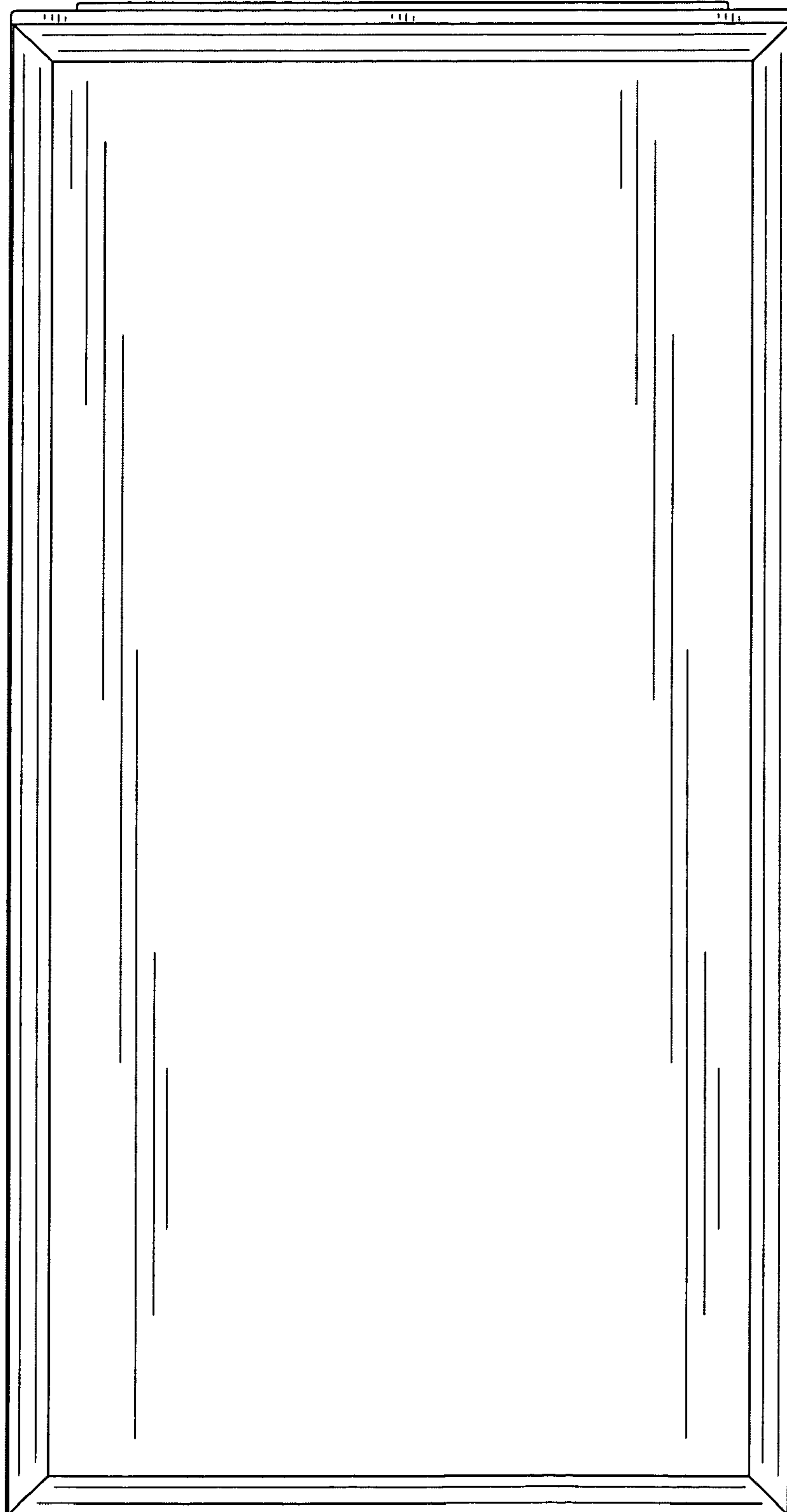

FIG.4

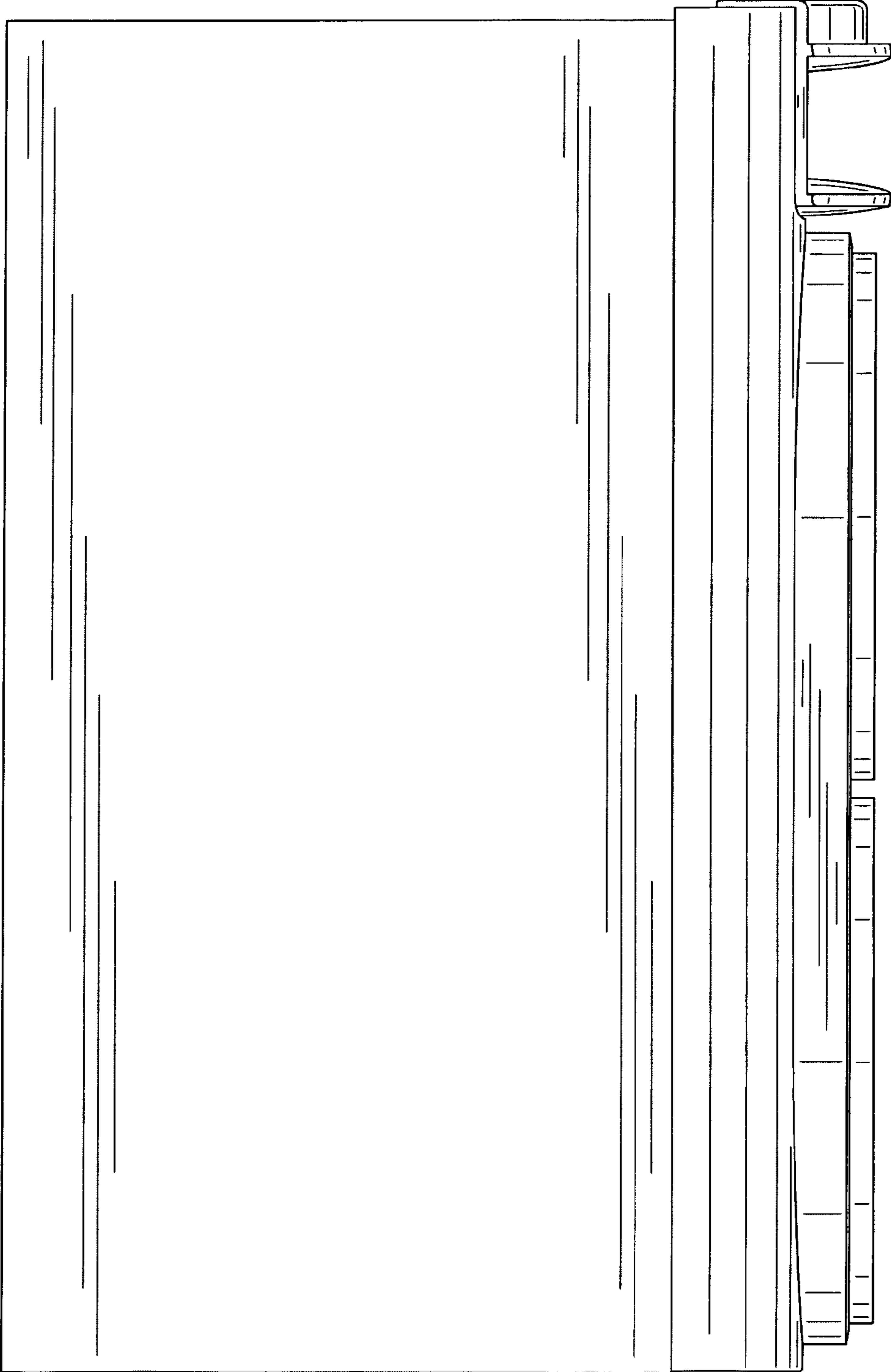

FIG.5

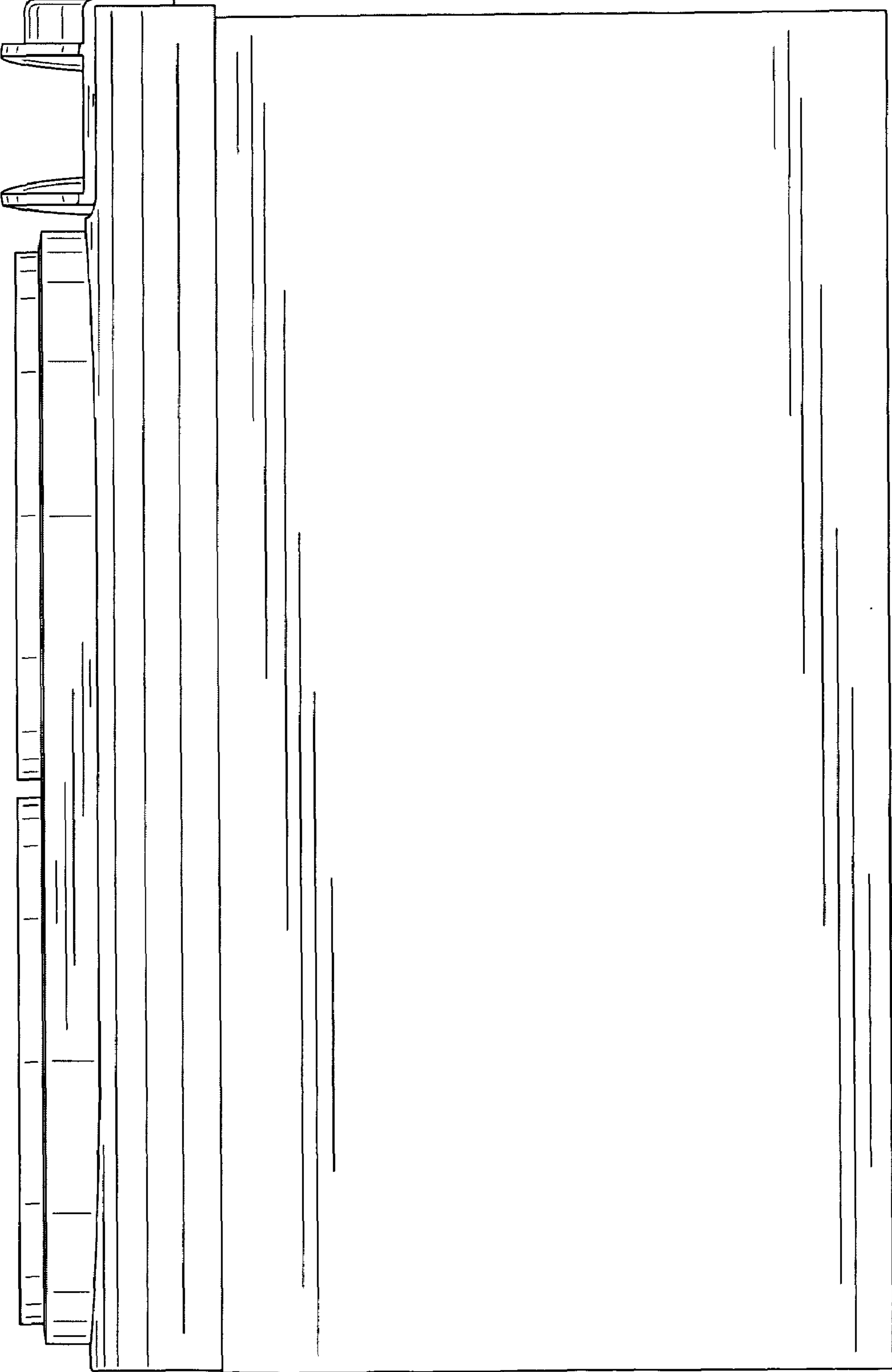

FIG.6

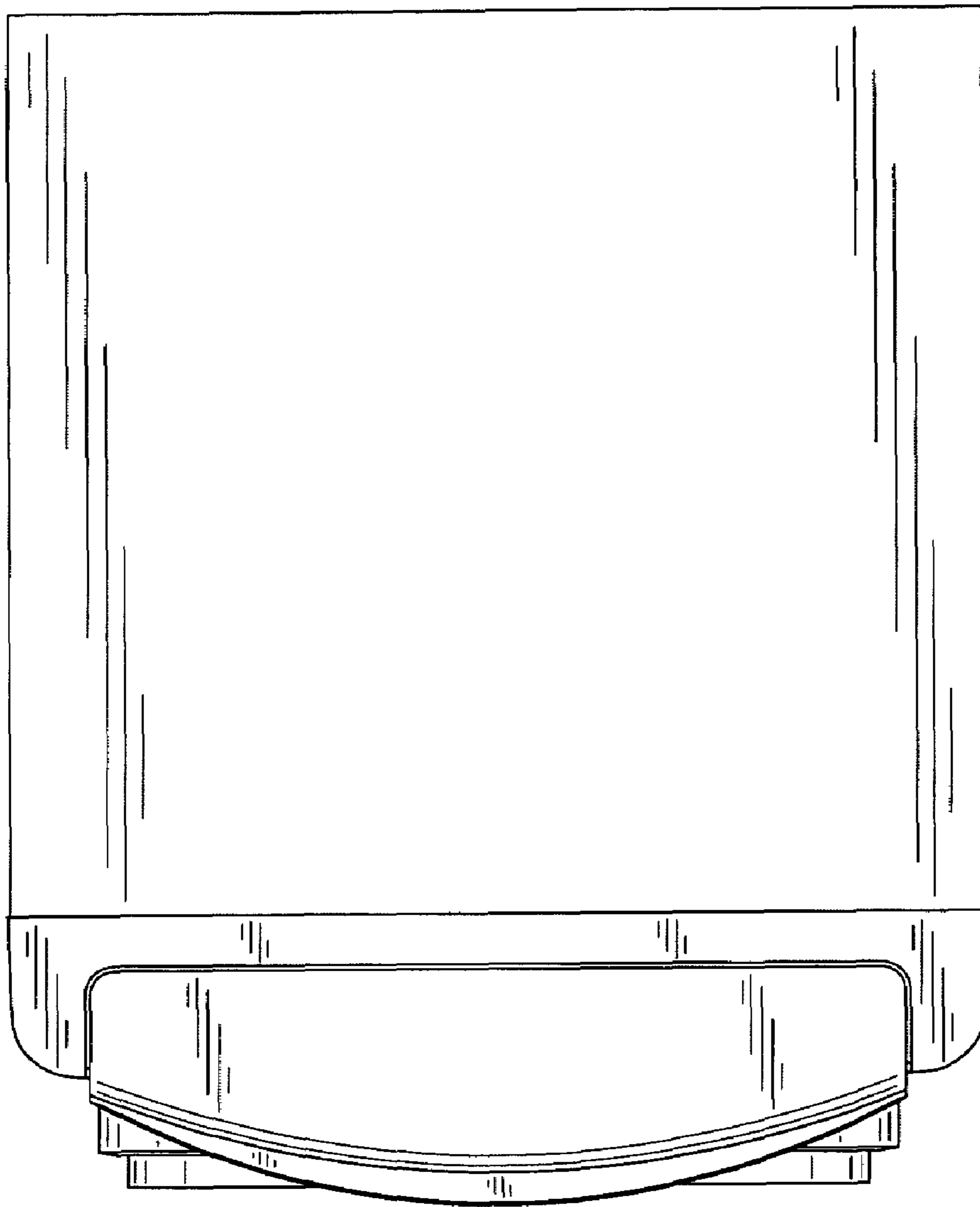

FIG.7

