



US00D592536S

(12) **United States Design Patent**
Chan Chen

(10) **Patent No.:** **US D592,536 S**

(45) **Date of Patent:** **** May 19, 2009**

(54) **COMBINED EMERGENCY AND EXIT LIGHT**

(76) **Inventor:** **Hsiu-Li Chan Chen**, 2Fl., 15, Alley 2,
Lane 95, Sec. 3, Muxin Road, Taipei
(TW)

(**) **Term:** **14 Years**

(21) **Appl. No.:** **29/319,872**

(22) **Filed:** **Jun. 17, 2008**

(51) **LOC (9) Cl.** **10-05**

(52) **U.S. Cl.** **D10/114**

(58) **Field of Classification Search** D10/109,
D10/113, 114; 362/235, 227, 485; D26/80,
D26/139, 28-31, 60, 119, 120; D20/10;
116/42; 340/332

See application file for complete search history.

(56) **References Cited**

U.S. PATENT DOCUMENTS

D57,850 S *	5/1921	Mullvain	D26/30
1,806,276 A *	5/1931	Bailey	116/42
D115,802 S *	7/1939	Soderberg	D26/30
D115,949 S *	8/1939	Brady	D26/30
D118,312 S *	12/1939	Pope	D26/30
D152,684 S *	2/1949	Feltz	D26/30
D313,661 S *	1/1991	Kang	D26/31

D391,992 S *	3/1998	Vosika et al.	D20/10
6,294,983 B1 *	9/2001	Lee	340/332
2003/0076313 A1 *	4/2003	Minato et al.	345/204

* cited by examiner

Primary Examiner—Caron Veynar

Assistant Examiner—George D Kirschbaum

(74) *Attorney, Agent, or Firm*—Ming Chow; Sinorica, LLC

(57) **CLAIM**

The ornamental design for a combined emergency and exit light, as shown.

DESCRIPTION

FIG. 1 is a perspective view of the design for a combined emergency and exit light;

FIG. 2 is a front view of the design;

FIG. 3 is a rear view of the design;

FIG. 4 is a right side view of the design;

FIG. 5 is a left side view of the design;

FIG. 6 is a top view of the design;

FIG. 7 is a bottom view of the design; and,

FIG. 8 is a front view of the design.

1 Claim, 7 Drawing Sheets

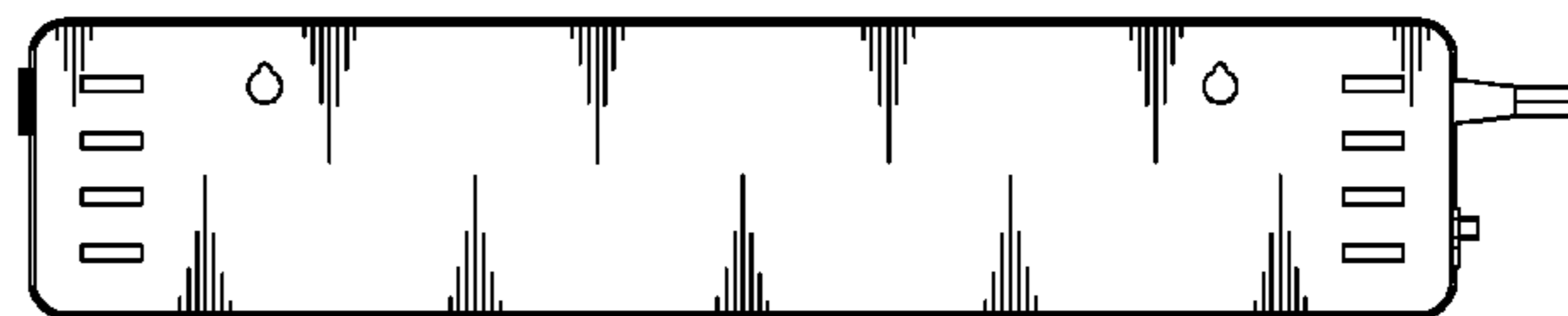
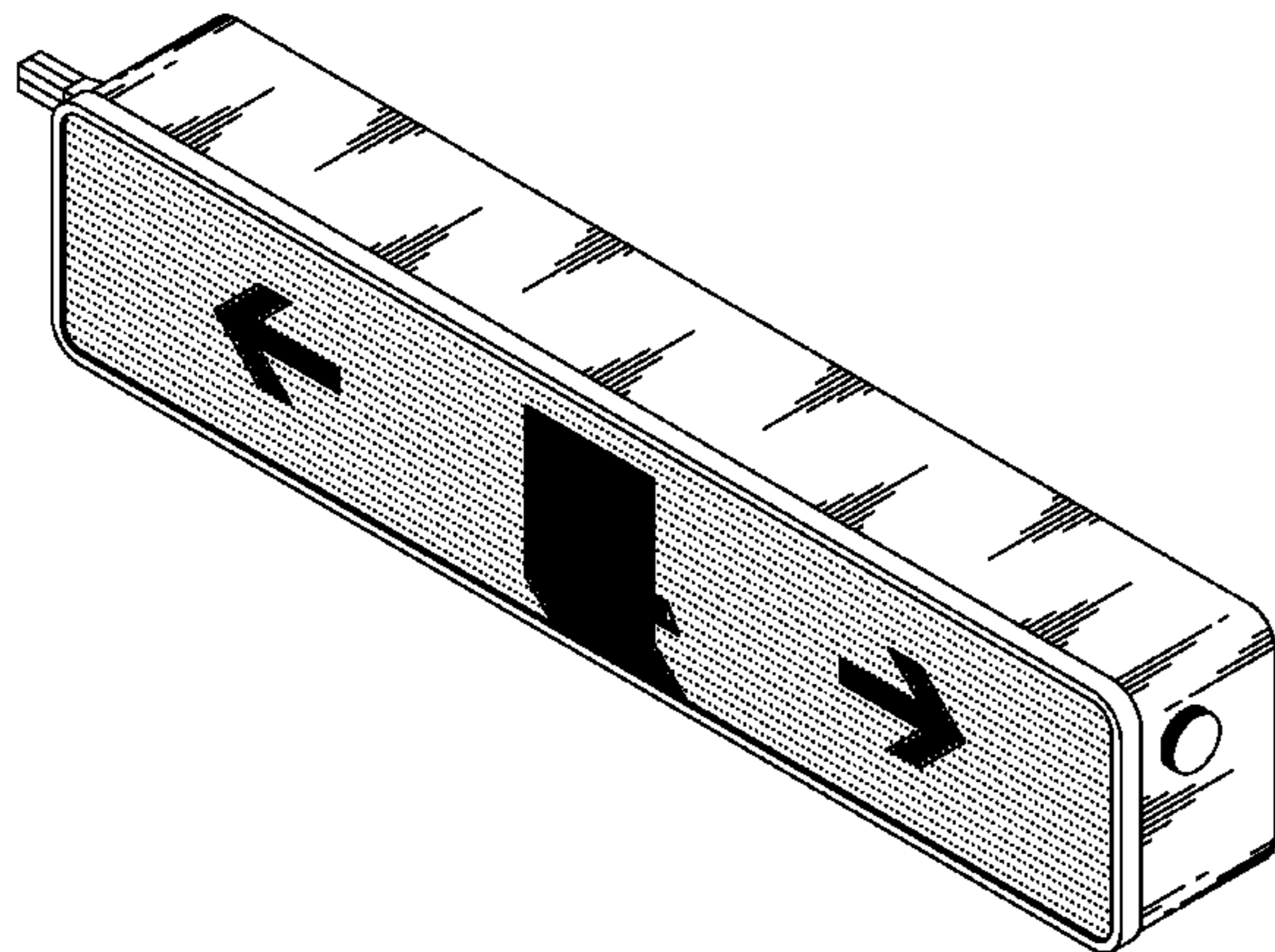

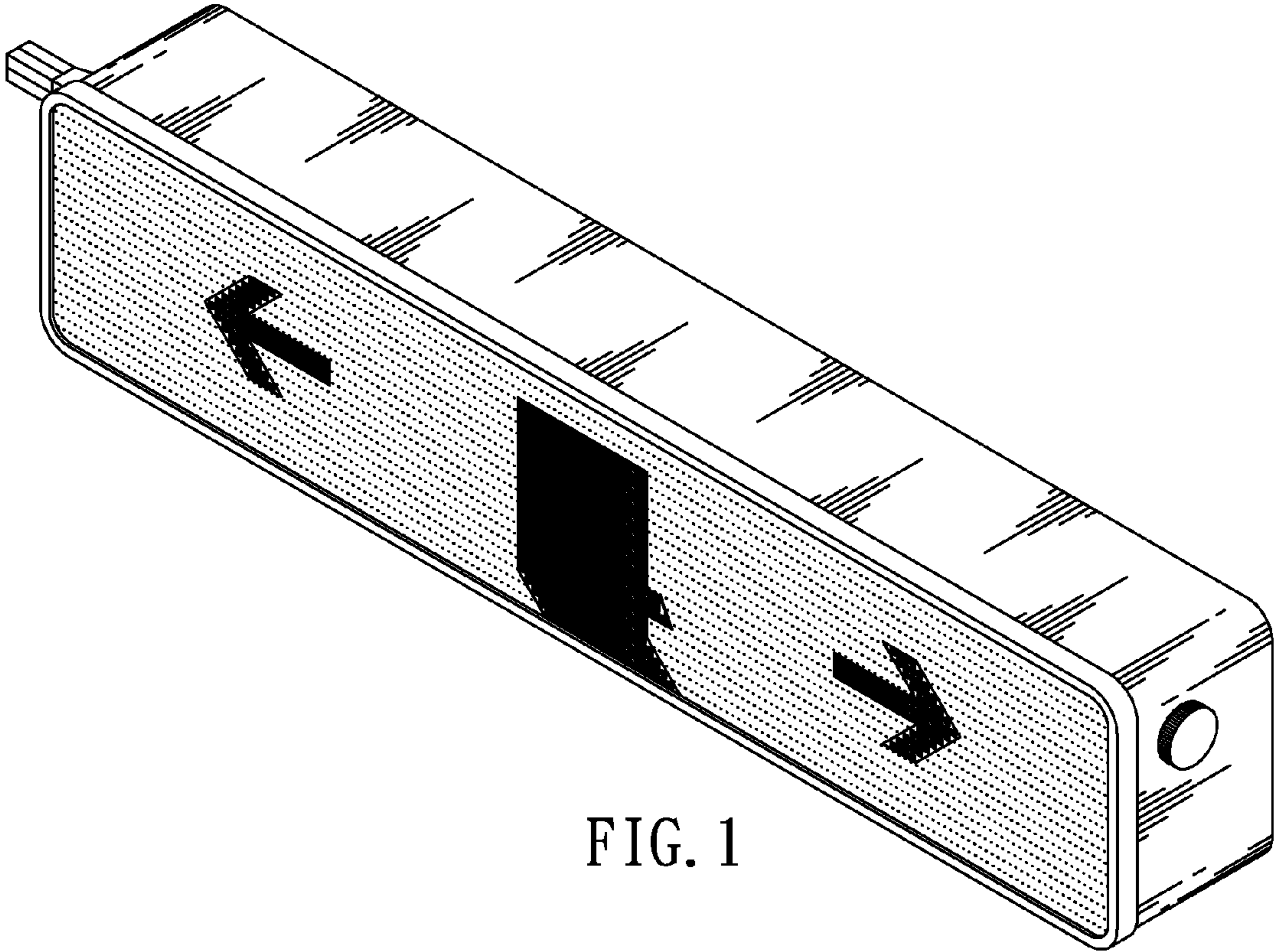

FIG. 1

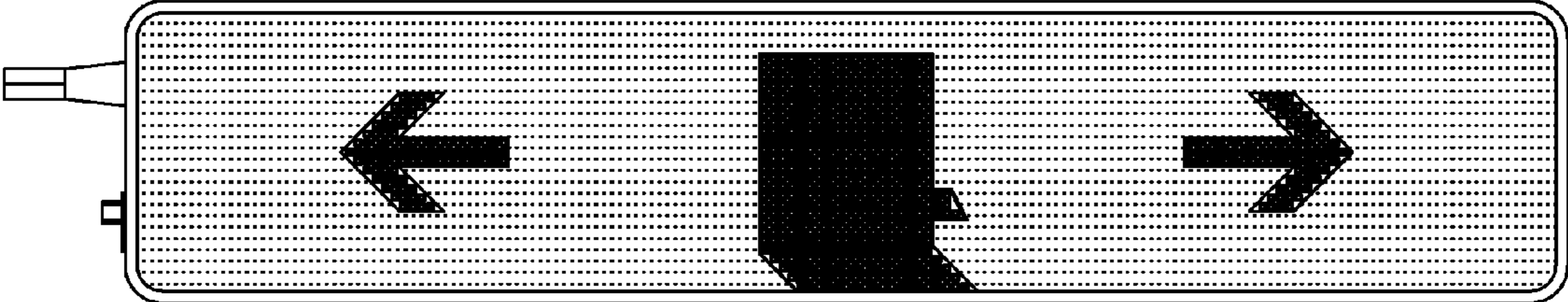

FIG. 2

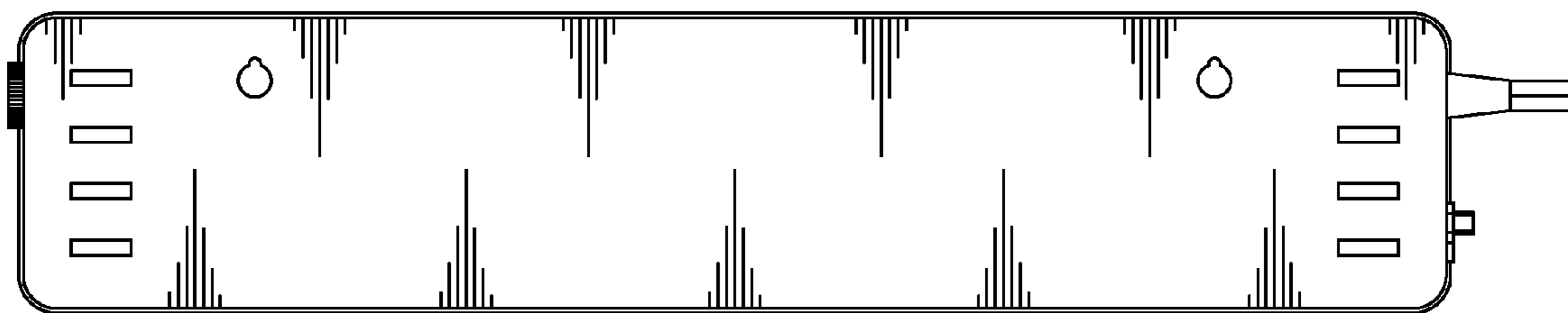

FIG. 3

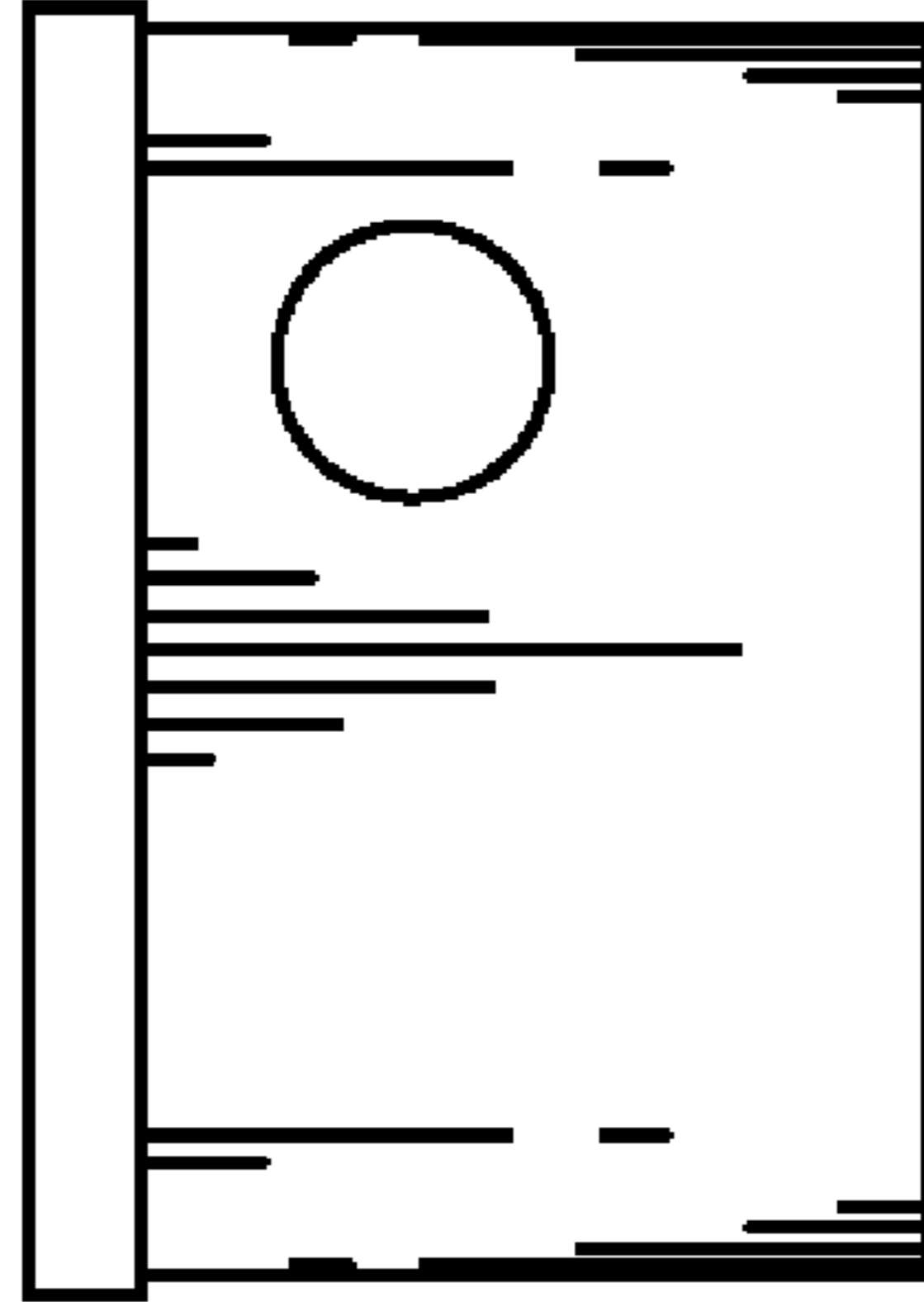

FIG. 4

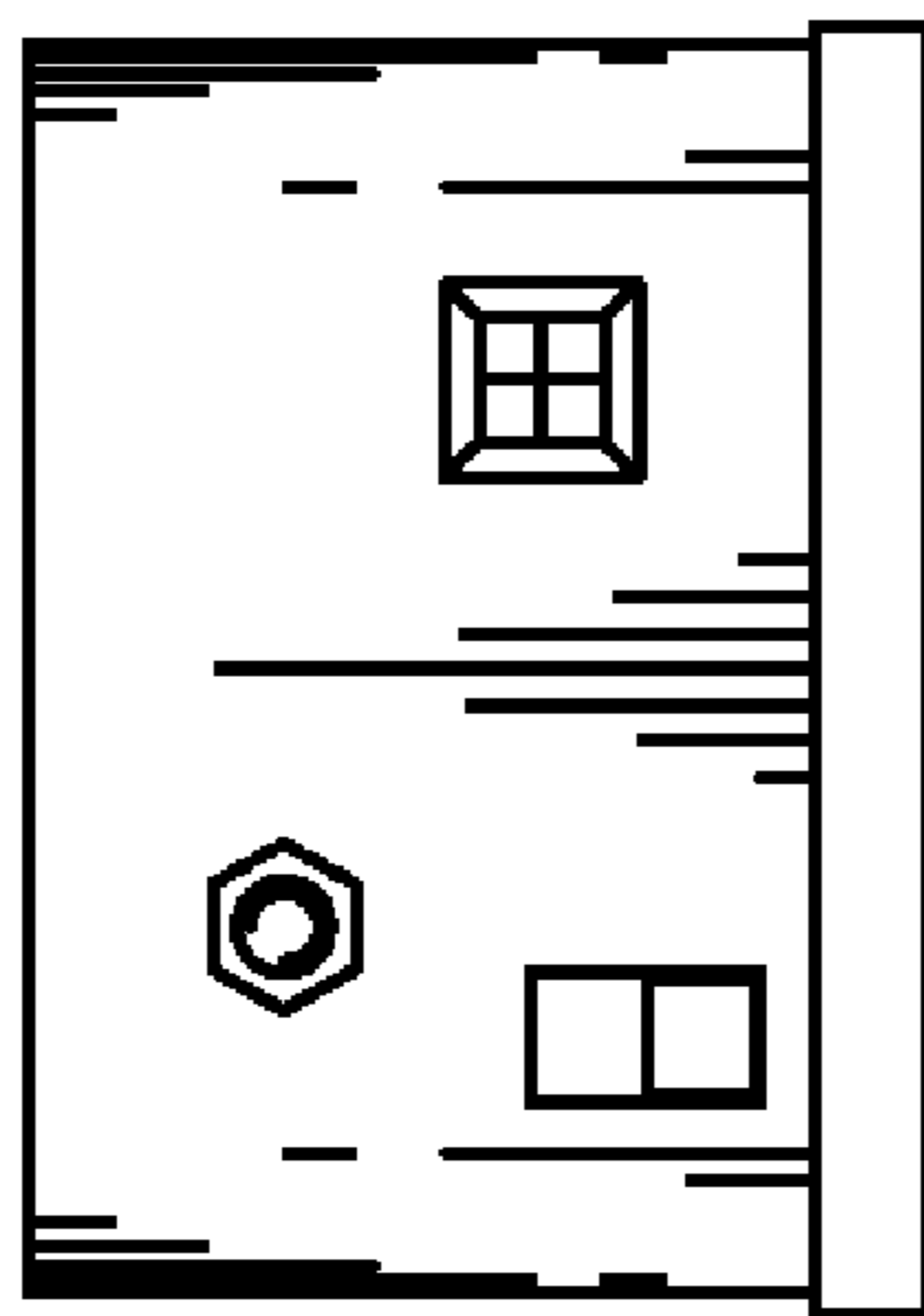

FIG. 5

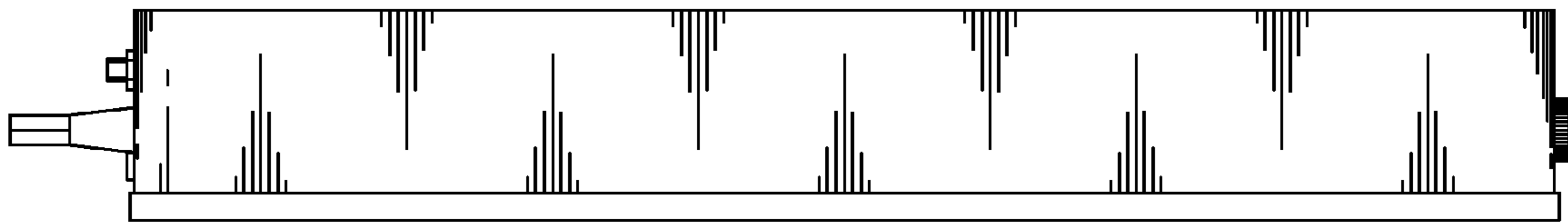

FIG. 6

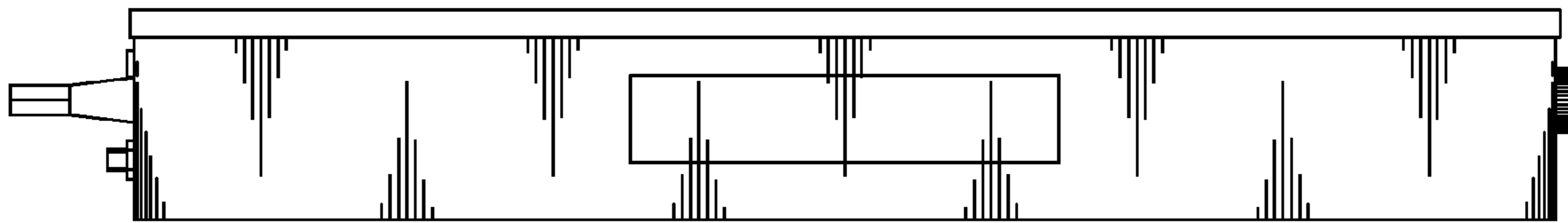

FIG. 7

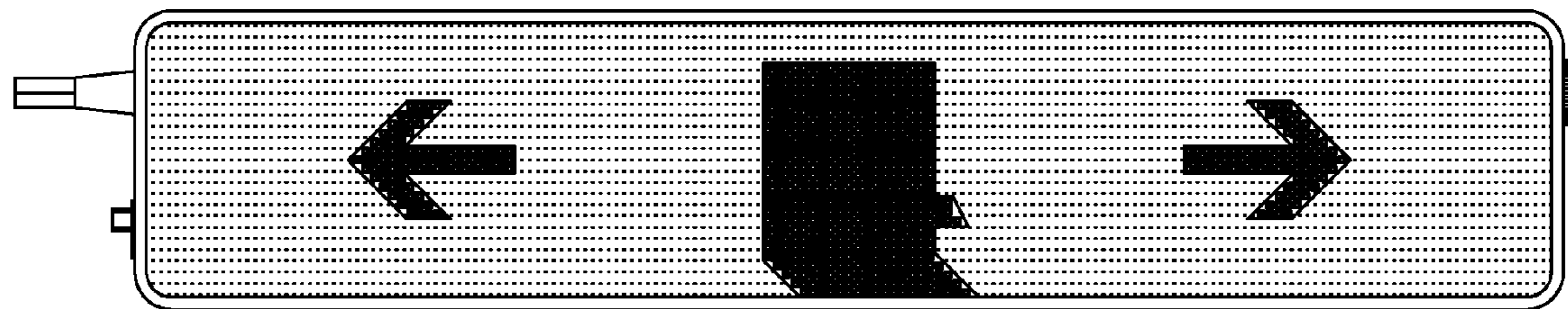

FIG. 8