

US00D592467S

(12) **United States Design Patent**
Heintzinger

(10) **Patent No.:** **US D592,467 S**

(45) **Date of Patent:** **** May 19, 2009**

(54) **ROASTING STICK FOR OPEN FIRE ROASTING**

(57) **CLAIM**

(76) **Inventor:** **Thomas A Heintzinger**, 10204 SE.
270th Pl., Kent, WA (US) 98031

I claim the ornamental design for a roasting stick for open fire roasting, as shown and described.

(**) **Term:** **14 Years**

DESCRIPTION

(21) **Appl. No.:** **29/323,785**

FIG. 1 is perspective view of a roasting stick for open fire roasting in a form of a stick figure suggestive of a person, the roasting stick for open fire roasting comprising a shank and a tine on a shank first end shown with an article of food to be roasted mounted on the tine. Also on the shank first end is a body component, two arm components, two leg components and a head component to which the tine is attached, all configured as shown.

(22) **Filed:** **Aug. 29, 2008**

(51) **LOC (9) Cl.** **07-06**

(52) **U.S. Cl.** **D7/684**

(58) **Field of Classification Search** D7/683,
D7/684, 686, 387; 294/1.1, 5, 26, 50, 55.5,
294/61; 99/419, 427, 421 A, 421 H, 441
See application file for complete search history.

FIG. 2 is a perspective view of the roasting stick for open fire roasting of FIG. 1 shown without a food article mounted on the tine.

(56) **References Cited**

U.S. PATENT DOCUMENTS

D192,256 S *	2/1962	Ackerson	D7/686
6,012,749 A *	1/2000	Farber et al.	294/5
D502,631 S *	3/2005	Burke	D7/387
D541,113 S *	4/2007	West et al.	D7/684
D541,114 S *	4/2007	West et al.	D7/684

FIG. 3 is a top view of the roasting stick for open fire roasting of FIG. 1.

FIG. 4 is a bottom view of the roasting stick for open fire roasting of FIG. 1.

FIG. 5 is a side view of the roasting stick for open fire roasting of FIG. 1.

FIG. 6 is a front end view of the roasting stick for open fire roasting of FIG. 1; and,

FIG. 7 is a back end view of the roasting stick for open fire roasting of FIG. 1.

The broken lines showing the article of food is for illustrative purposes only and form no part of the claimed design.

* cited by examiner

Primary Examiner—Terry A Wallace
(74) *Attorney, Agent, or Firm*—David L Tingey

1 Claim, 4 Drawing Sheets

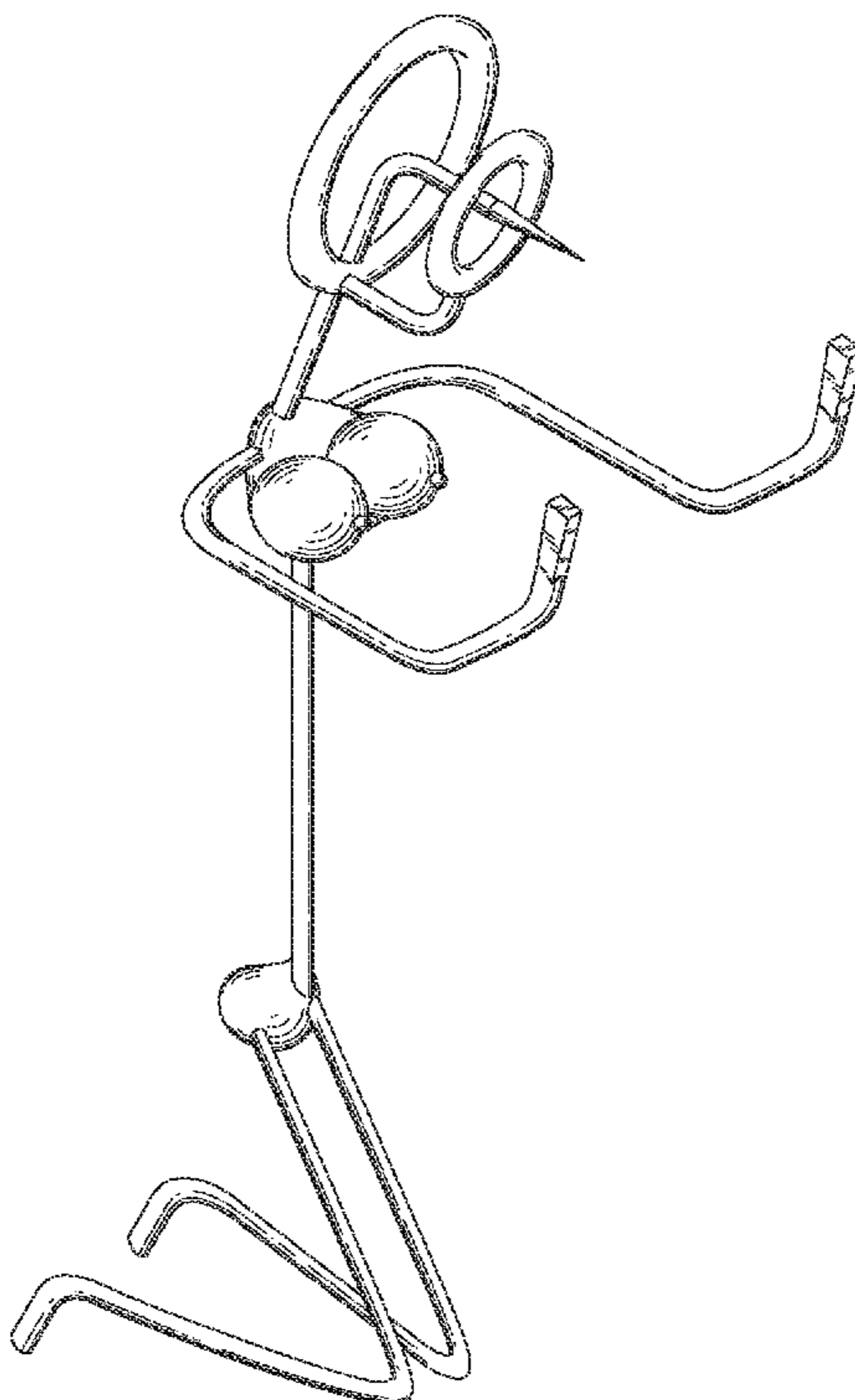

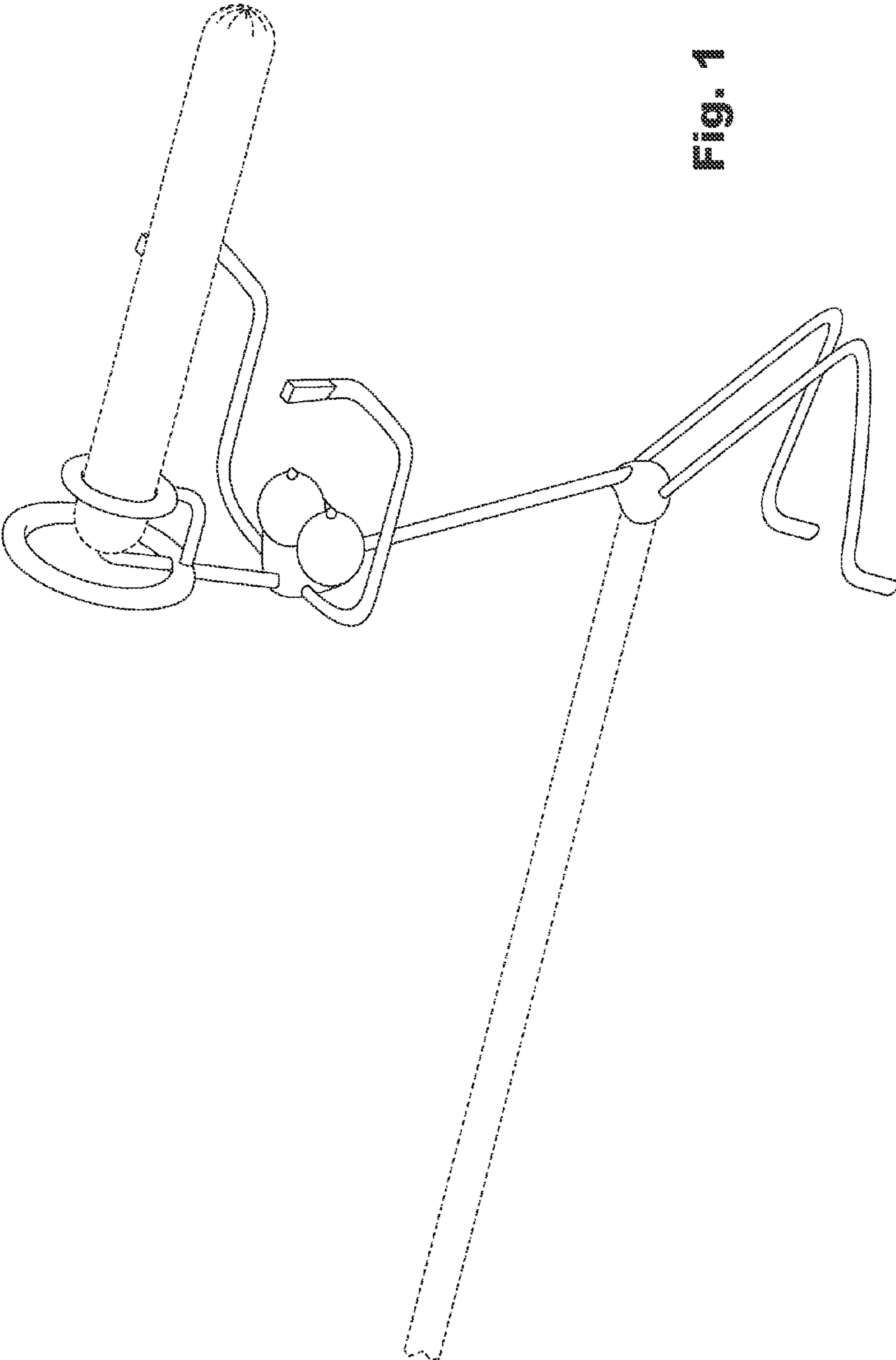

Fig. 1

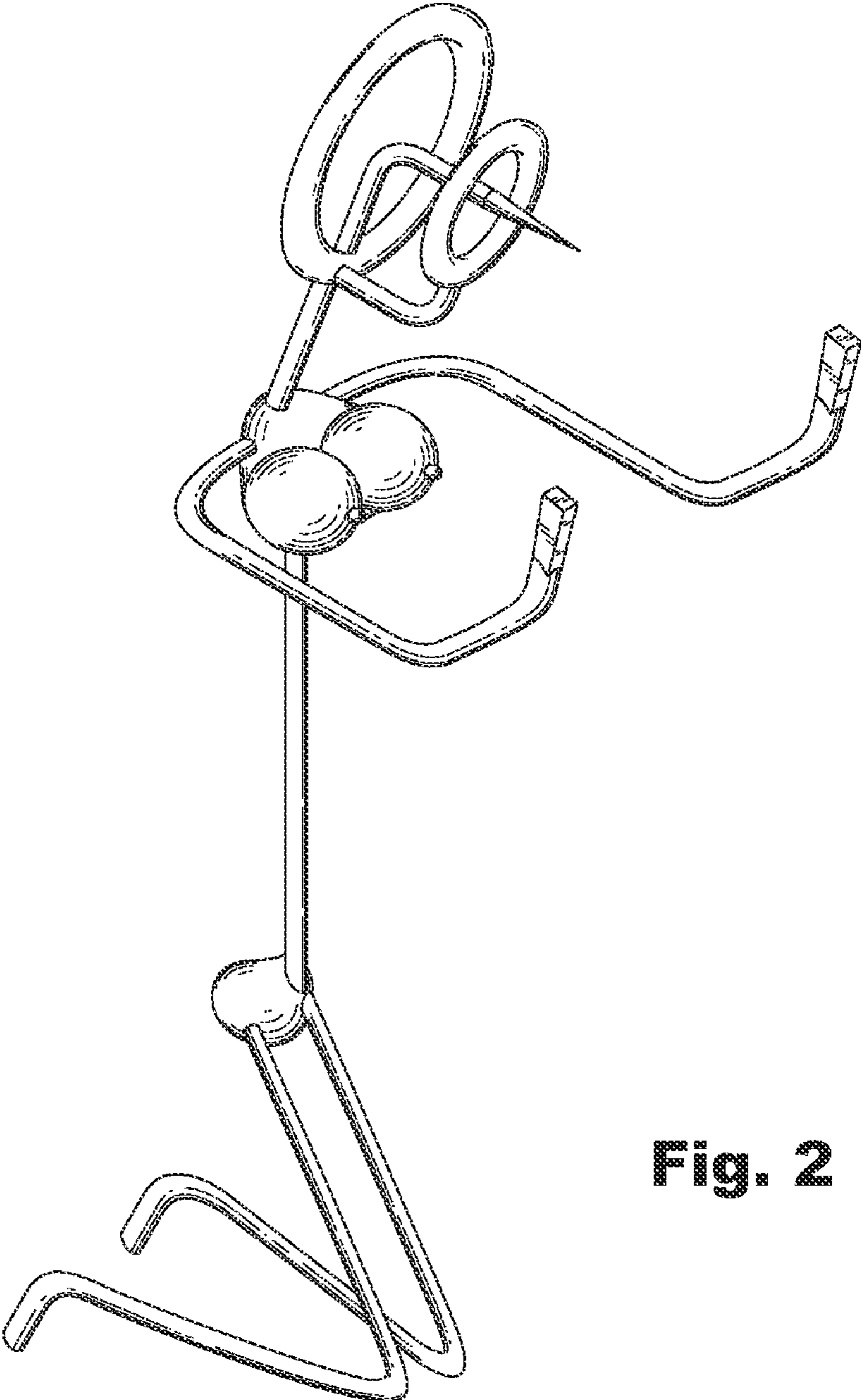

Fig. 2

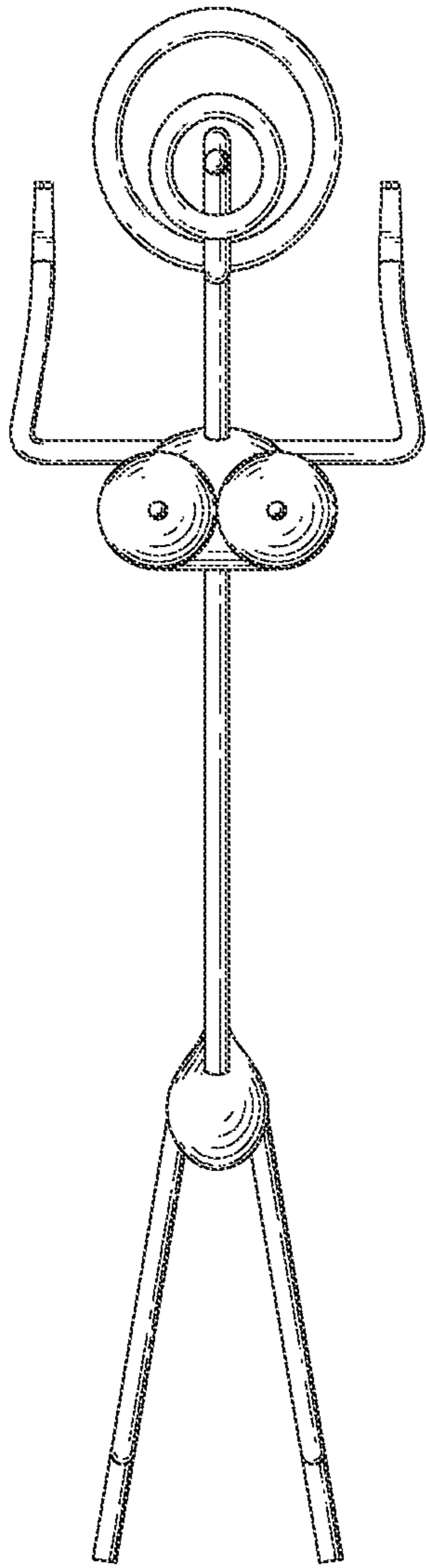

Fig. 3

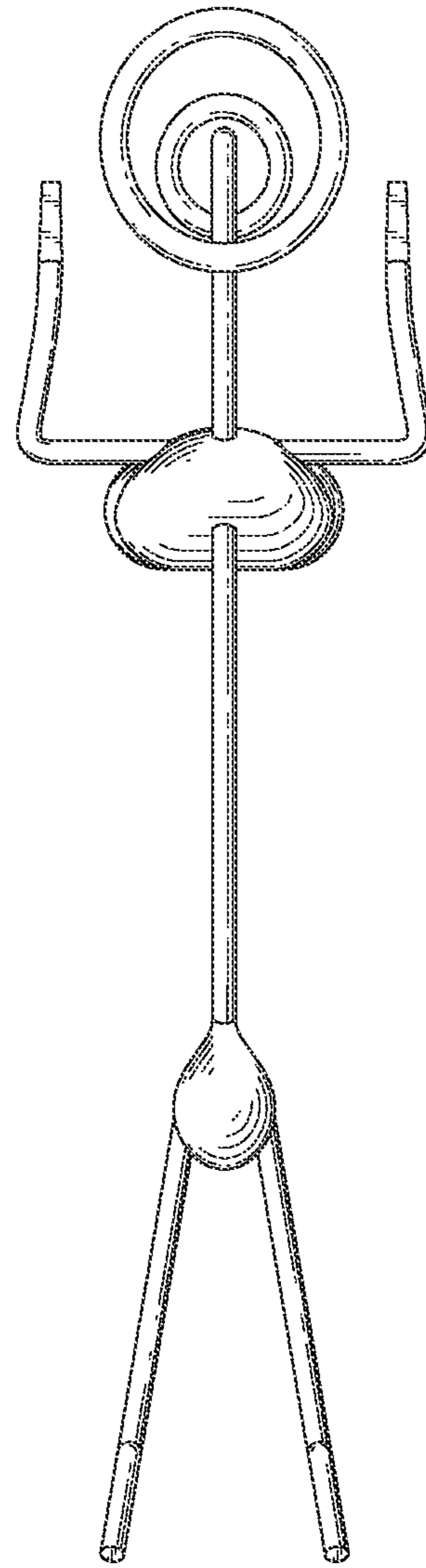

Fig. 4

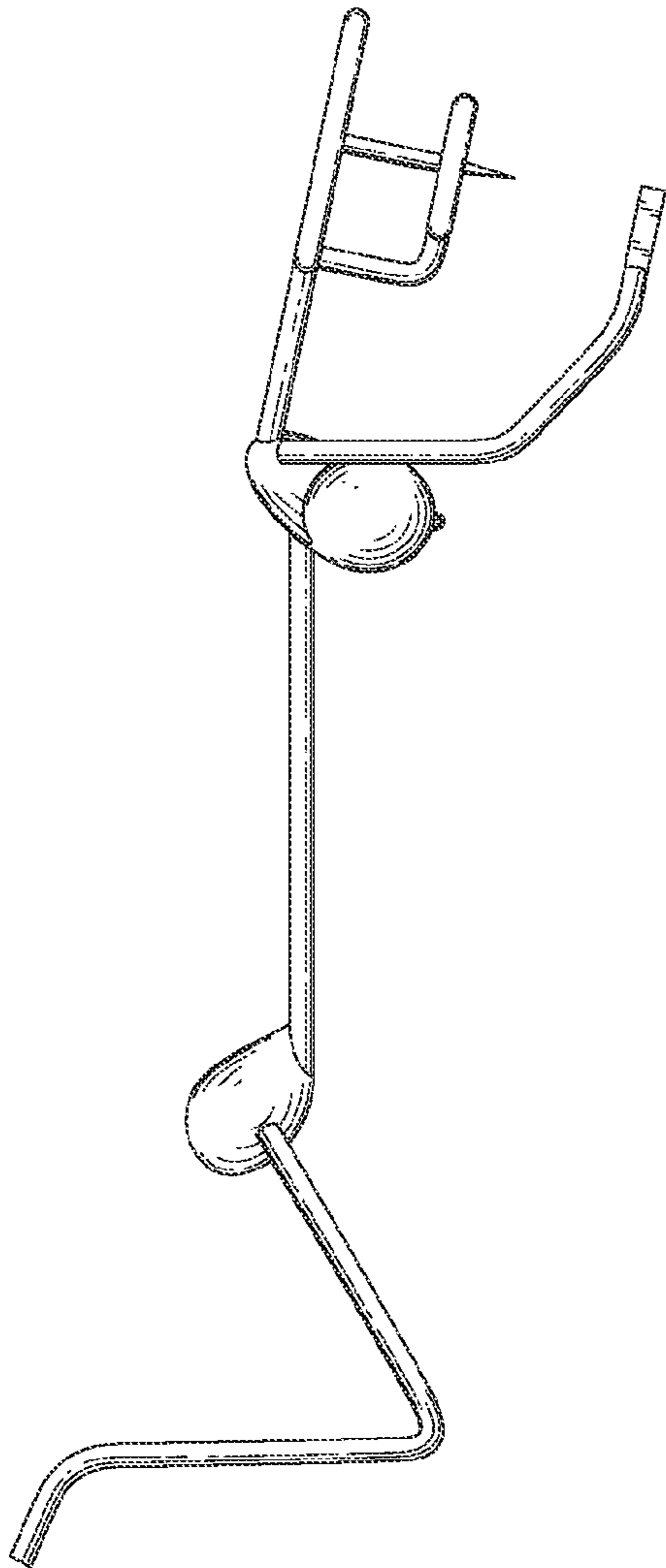

Fig. 5

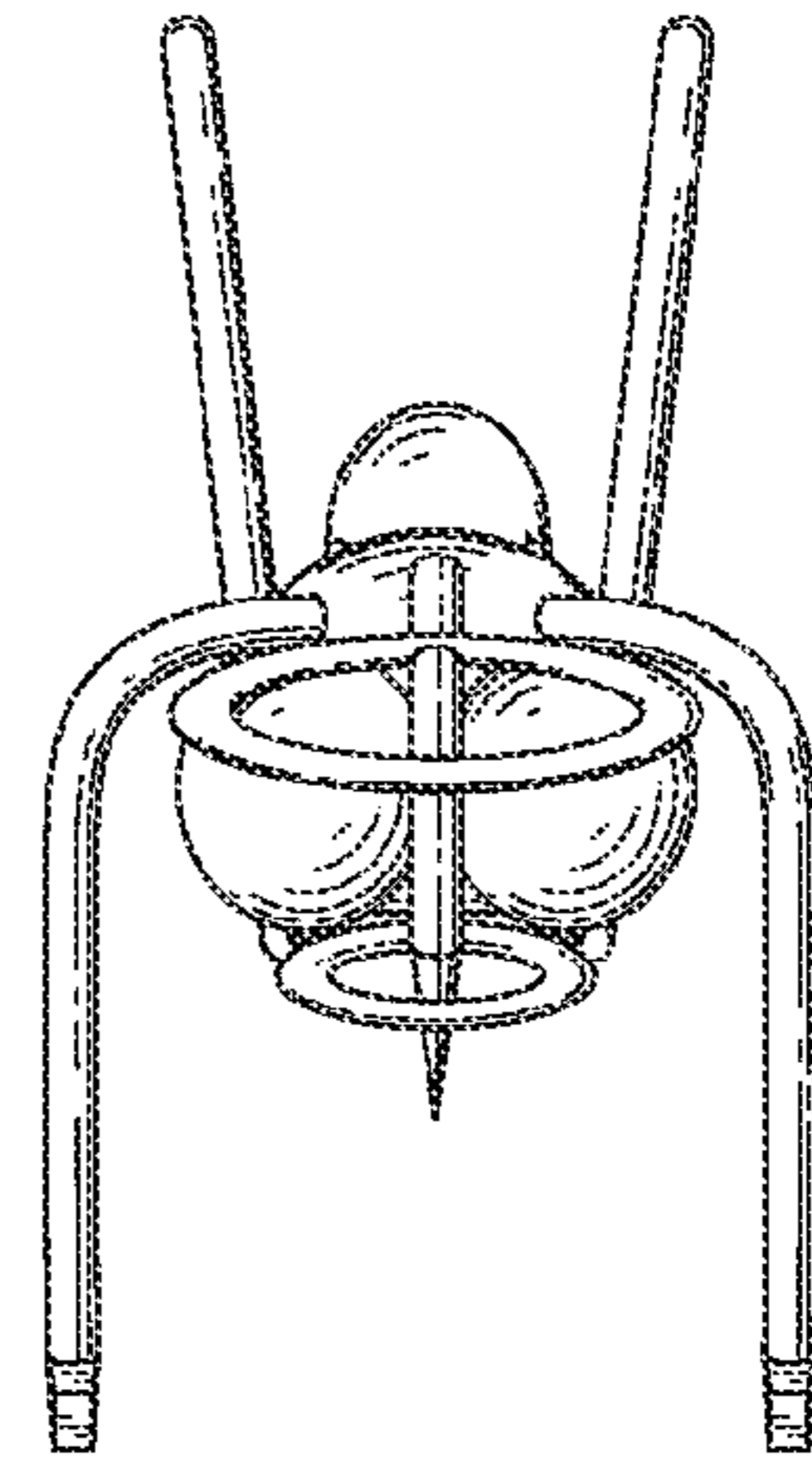

Fig. 6

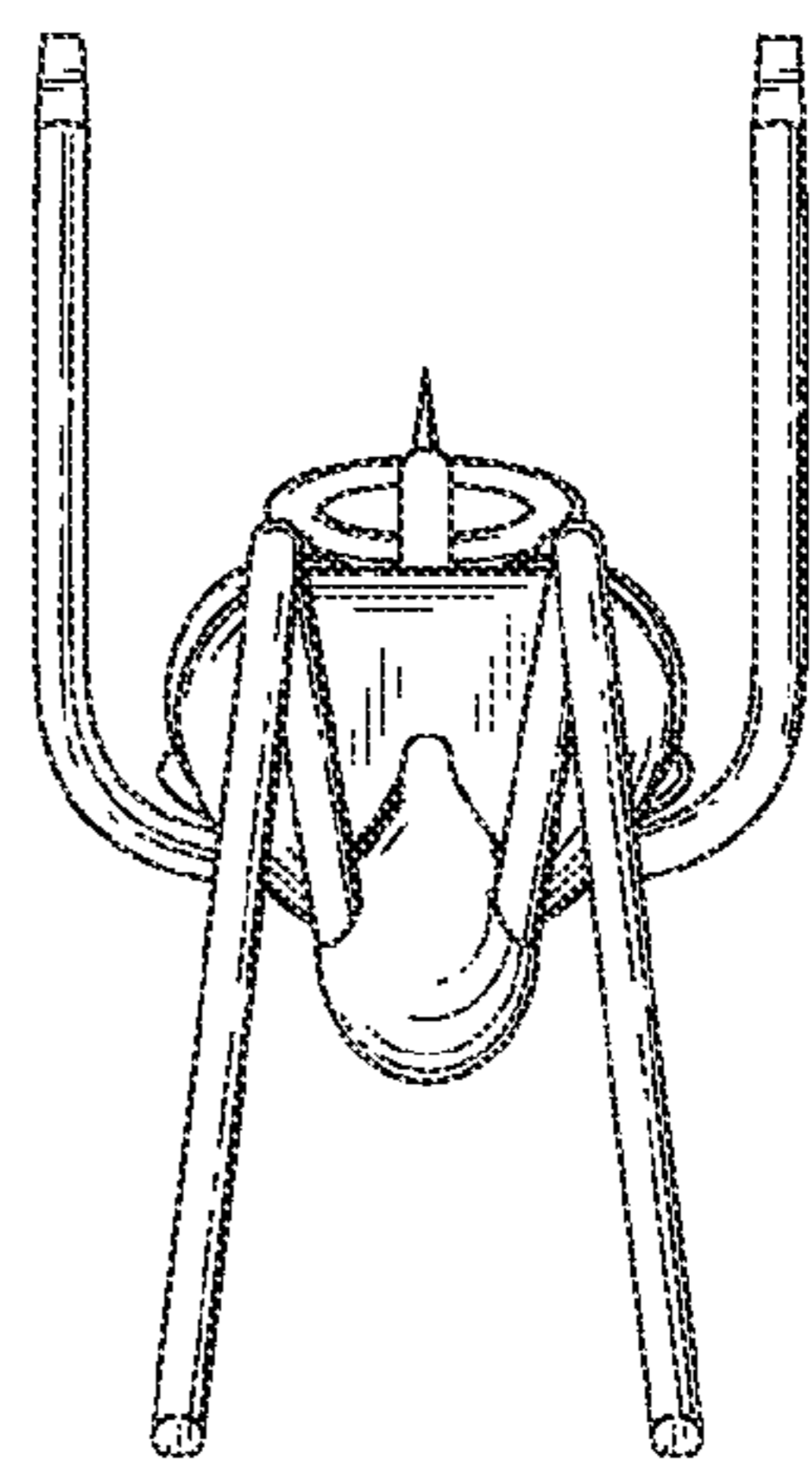

Fig. 7