

US00D592453S

(12) **United States Design Patent**  
**Rasa**

(10) **Patent No.:** **US D592,453 S**

(45) **Date of Patent:** **\*\* May 19, 2009**

(54) **PEELER BLADE**

(76) **Inventor:** **Iwan Rasa**, Zollhausstrasse 16, CH-8505 Pfyn (CH)

(\*\*) **Term:** **14 Years**

(21) **Appl. No.:** **29/243,624**

(22) **Filed:** **Nov. 30, 2005**

(51) **LOC (9) Cl.** ..... **07-02**

(52) **U.S. Cl.** ..... **D7/412**

(58) **Field of Classification Search** ..... D7/372,  
D7/376-386, 393, 395, 412-414, 505, 665,  
D7/673, 678, 693, 695; 30/120.1, 123.5,  
30/278, 279.6, 280, 294, 304, 315; 83/425.3,  
83/858; 99/492, 495, 509-511, 584, 588;  
366/64-67, 98, 197-207, 241-254, 279-292,  
366/341-343

See application file for complete search history.

(56) **References Cited**

**U.S. PATENT DOCUMENTS**

|           |     |         |                  |       |          |
|-----------|-----|---------|------------------|-------|----------|
| 2,106,796 | A * | 2/1938  | De Vault         | ..... | 30/280   |
| 2,232,940 | A * | 2/1941  | Fender           | ..... | 30/278   |
| 2,238,425 | A * | 4/1941  | Morris           | ..... | 30/315   |
| 2,266,278 | A * | 12/1941 | Senkewitz        | ..... | 30/280   |
| D181,941  | S * | 1/1958  | Murphree         | ..... | D7/695   |
| 3,406,450 | A * | 10/1968 | Grotz            | ..... | 30/279.6 |
| D247,870  | S * | 5/1978  | Herrmeyer et al. | ..... | D7/695   |
| D262,770  | S * | 1/1982  | Propalis, Jr.    | ..... | D7/695   |
| D290,804  | S * | 7/1987  | Chasen           | ..... | D7/695   |
| D332,034  | S * | 12/1992 | Viemeister       | ..... | D7/695   |
| D397,921  | S * | 9/1998  | Joergensen       | ..... | D7/695   |

|           |      |         |                 |       |          |
|-----------|------|---------|-----------------|-------|----------|
| 5,865,110 | A *  | 2/1999  | Yonezawa        | ..... | 99/588   |
| D435,202  | S *  | 12/2000 | Ancona et al.   | ..... | D7/695   |
| D441,619  | S *  | 5/2001  | Darnell         | ..... | D7/695   |
| D442,036  | S *  | 5/2001  | Nilsson         | ..... | D7/695   |
| D461,692  | S *  | 8/2002  | Law             | ..... | D7/695   |
| D486,703  | S *  | 2/2004  | Settele         | ..... | D7/695   |
| D488,362  | S *  | 4/2004  | Overthun et al. | ..... | D7/695   |
| D501,123  | S *  | 1/2005  | Rasa            | ..... | D7/695   |
| D509,711  | S *  | 9/2005  | Bennerdahl      | ..... | D7/695   |
| D511,442  | S *  | 11/2005 | Lee             | ..... | D7/695   |
| D519,335  | S *  | 4/2006  | Ishii           | ..... | D7/695   |
| 7,065,882 | B2 * | 6/2006  | Haberstroh      | ..... | 30/279.6 |

\* cited by examiner

*Primary Examiner*—Caron Veynar  
*Assistant Examiner*—Ricky Pham

(57) **CLAIM**

The ornamental design for a peeler blade, as shown and described.

**DESCRIPTION**

FIG. 1. is a bottom view of the peeler blade showing my new design;

FIG. 2 is a front view thereof;

FIG. 3 is a top view thereof;

FIG. 4 is a left side view thereof, the right side being a mirror image;

FIG. 5 is a rear view thereof; and,

FIG. 6 is a side perspective view thereof.

**1 Claim, 1 Drawing Sheet**

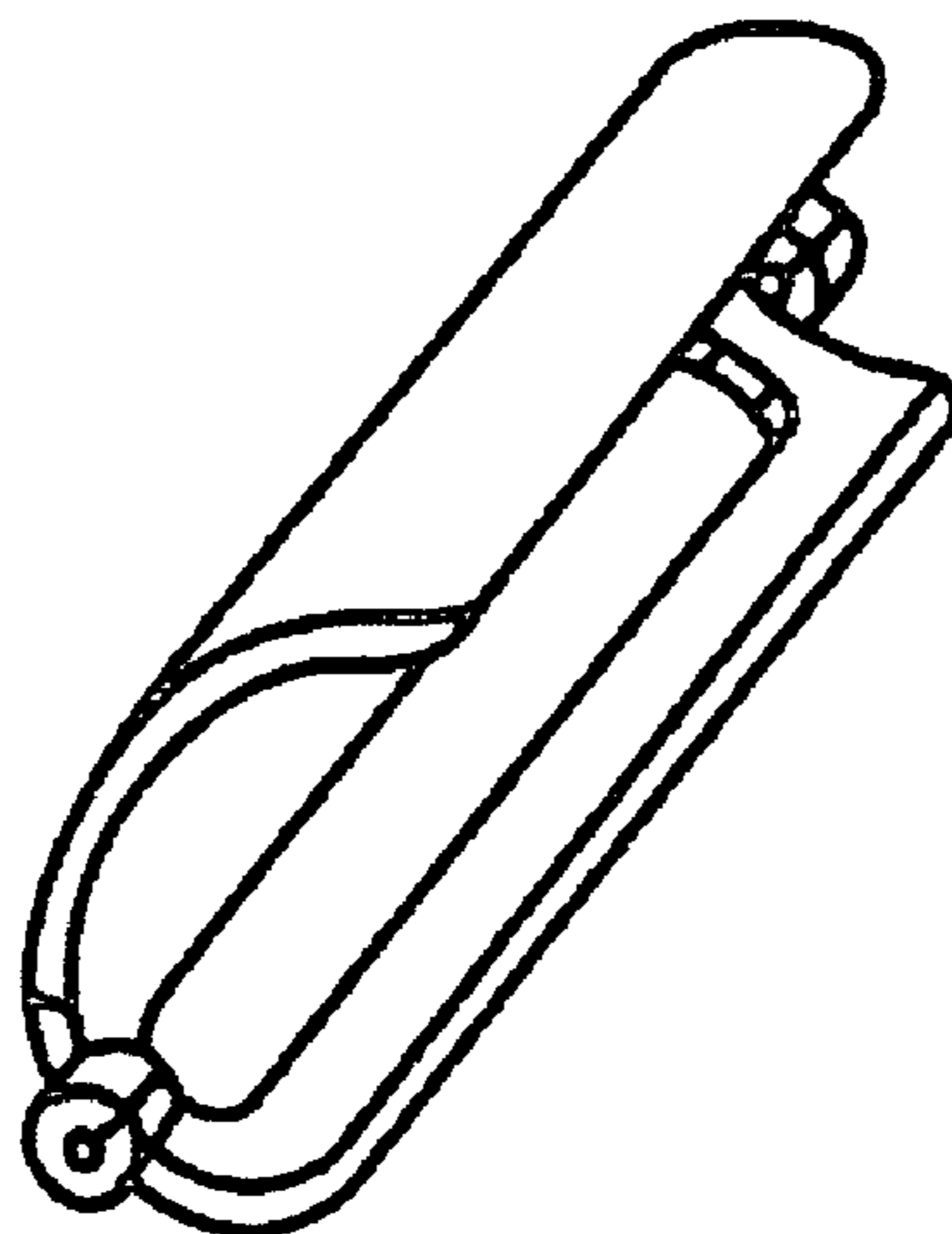
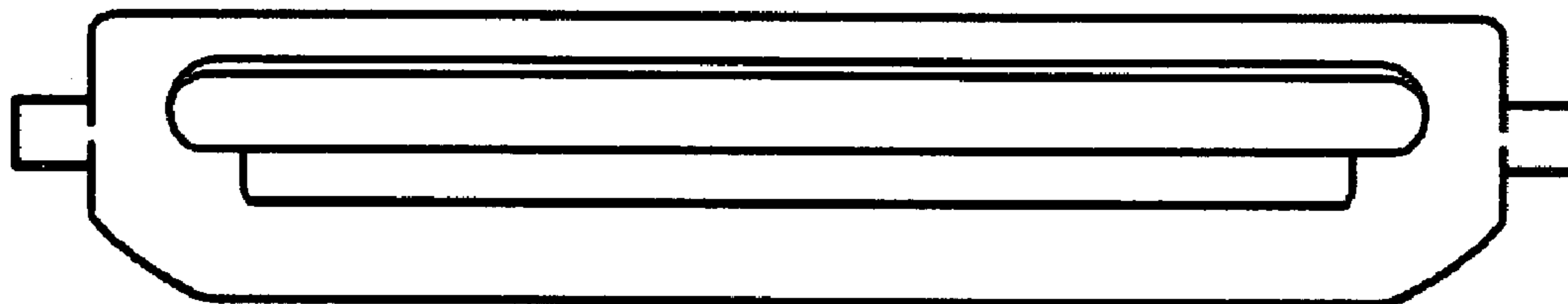

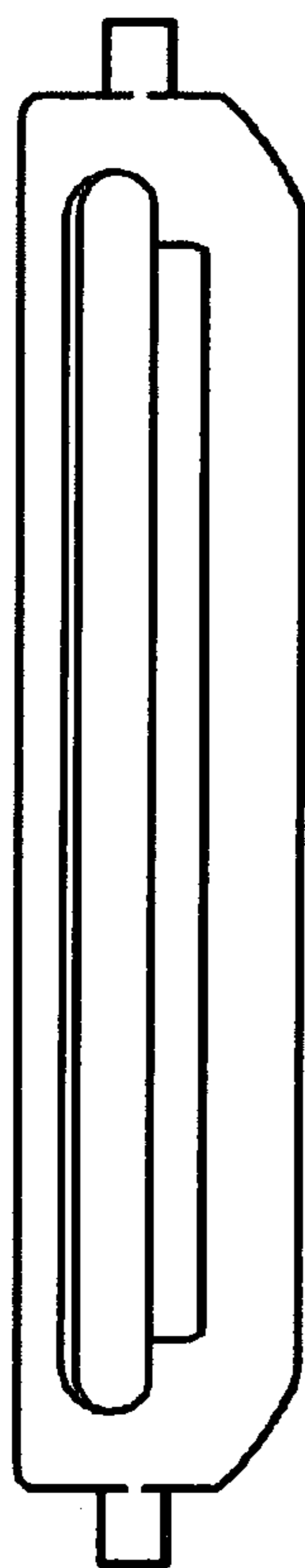

Fig.1



Fig. 4

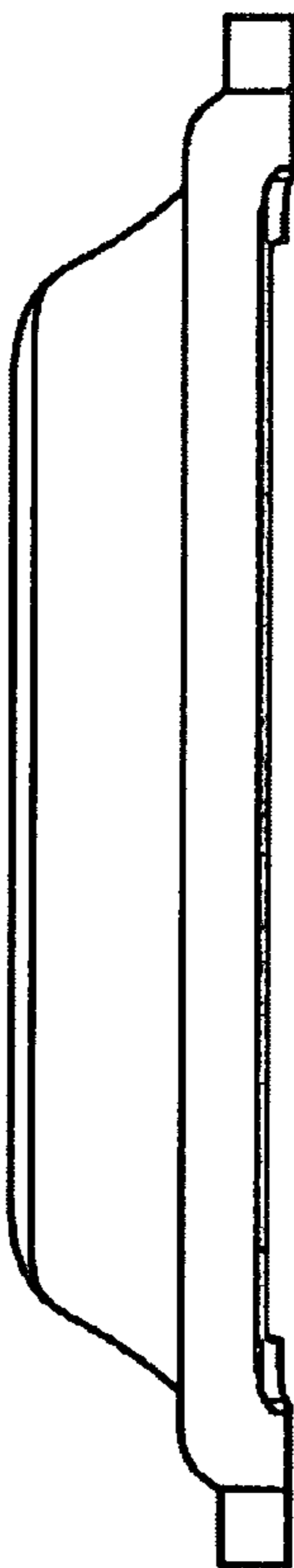

Fig.2

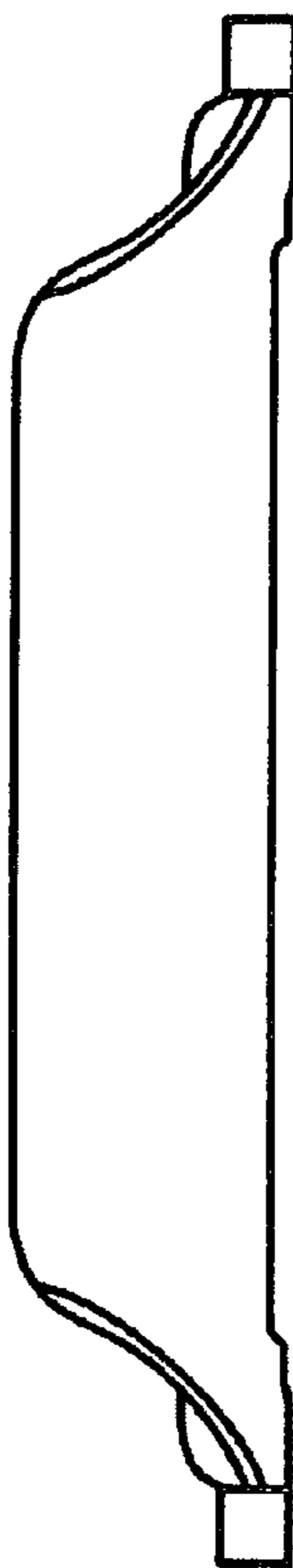

Fig. 5

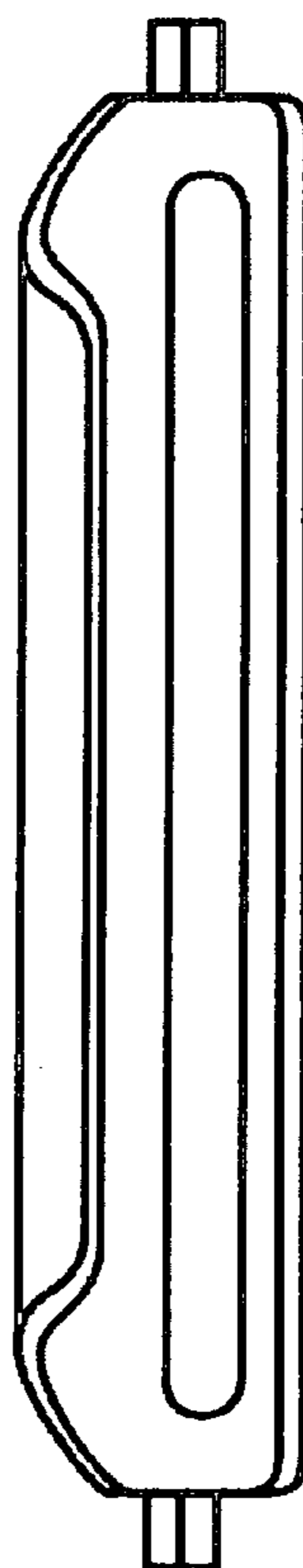

Fig.3

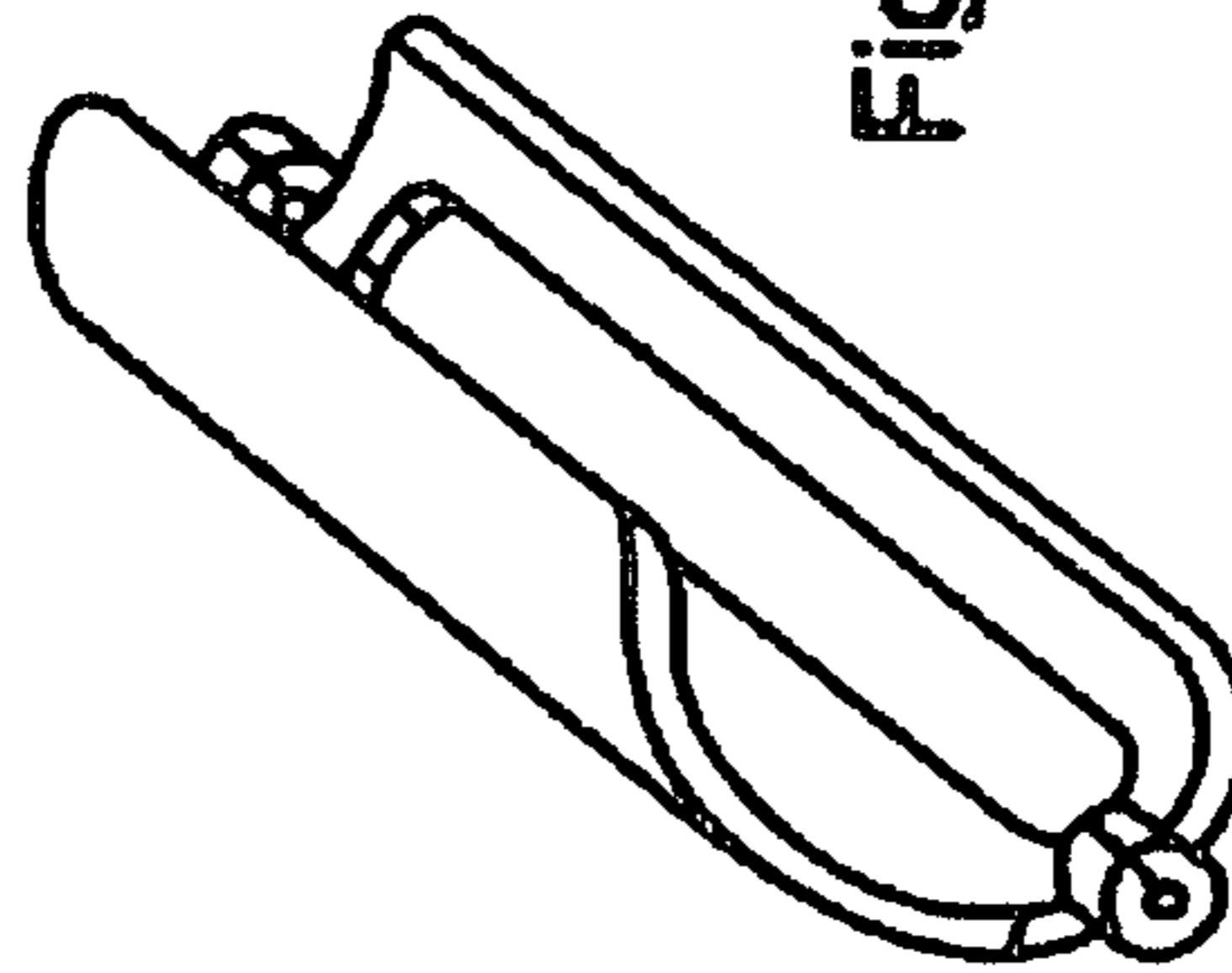

Fig. 6