



US00D592450S

(12) **United States Design Patent**  
**Rae**

(10) **Patent No.:** **US D592,450 S**

(45) **Date of Patent:** **\*\* May 19, 2009**

(54) **SAUCE PAN SIDE HANDLE**

(75) Inventor: **Robert A Rae**, Las Vegas, NV (US)

(73) Assignee: **Meyer Intellectual Properties Limited**  
(VG)

(\*\*) Term: **14 Years**

(21) Appl. No.: **29/323,032**

(22) Filed: **Aug. 15, 2008**

(51) **LOC (9) Cl.** ..... **07-02**

(52) **U.S. Cl.** ..... **D7/394**

(58) **Field of Classification Search** ..... D7/354-361,  
D7/393-395; D8/107, 300, 301, 307, 315,  
D8/317, 319; 16/430, 431, 110.1, 407, 441,  
16/443; 220/573.1-573.5, 752, 753, 755,  
220/756, 912

See application file for complete search history.

(56) **References Cited**

**U.S. PATENT DOCUMENTS**

D384,266 S \* 9/1997 Mantarakis et al. .... D8/301  
D384,568 S \* 10/1997 Mantarakis et al. .... D8/317  
D548,518 S \* 8/2007 Rae ..... D7/394  
D576,446 S \* 9/2008 Rae ..... D7/394

D584,105 S \* 1/2009 Moulin Robson ..... D7/394

\* cited by examiner

*Primary Examiner*—Holly H Baynham

*Assistant Examiner*—Cynthia M Chin

(74) *Attorney, Agent, or Firm*—Edward S. Sherman

(57) **CLAIM**

The ornamental design for a sauce pan side handle, as shown and described.

**DESCRIPTION**

FIG. 1 is a perspective view from above the front and side of the “sauce pan side handle”, showing my new design;

FIG. 2 is a top plan view thereof;

FIG. 3 is a front elevation thereof;

FIG. 4 is a side elevation view thereof;

FIG. 5 is a bottom plan view thereof;

FIG. 6 is a back elevation view thereof; and,

FIG. 7 is a bottom perspective view thereof.

The broken lines in FIGS. 1-7 are for illustrative purposes only, depicting the rivet holes in the handle, forming no part thereof as claimed.

**1 Claim, 1 Drawing Sheet**

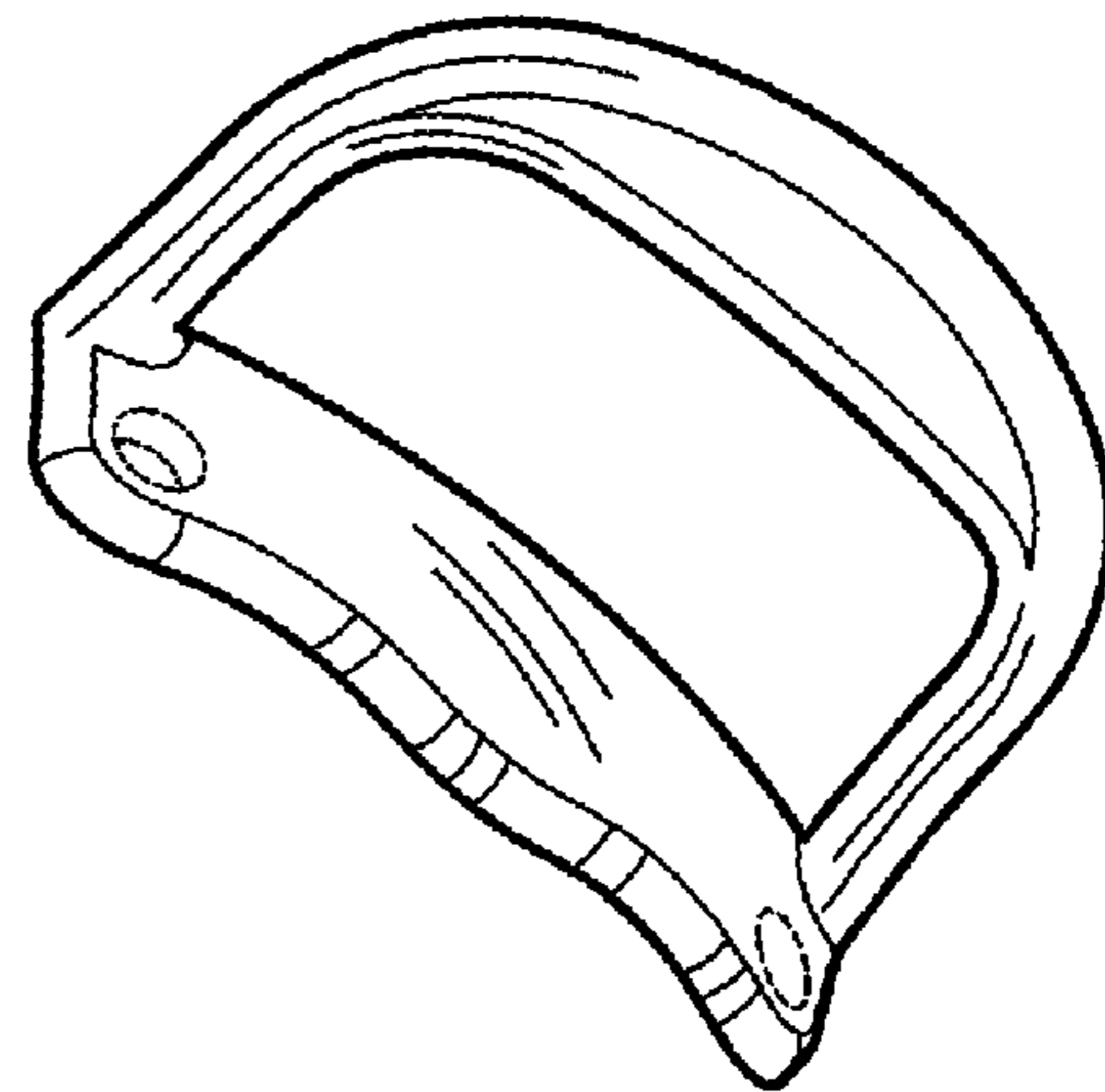
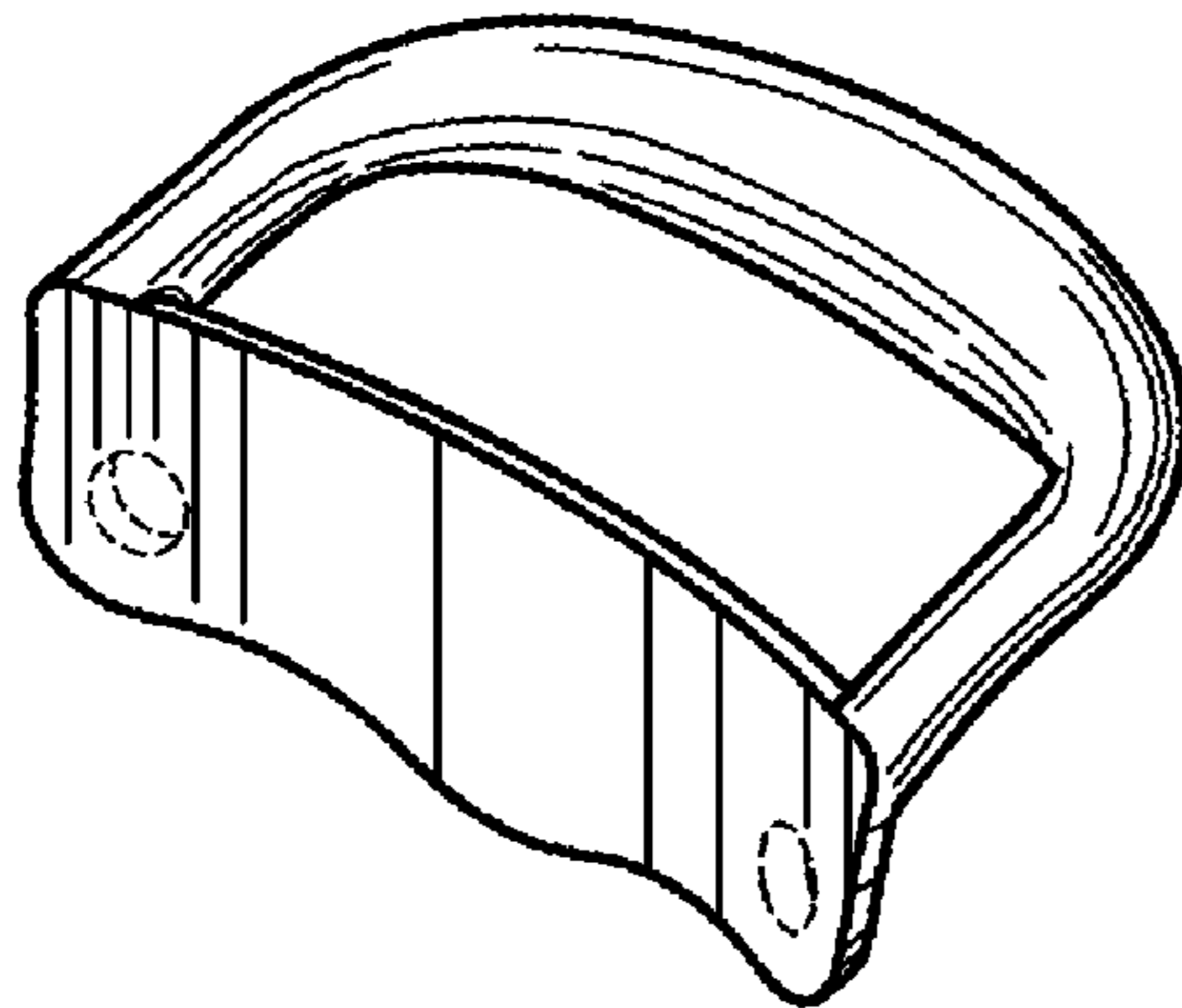

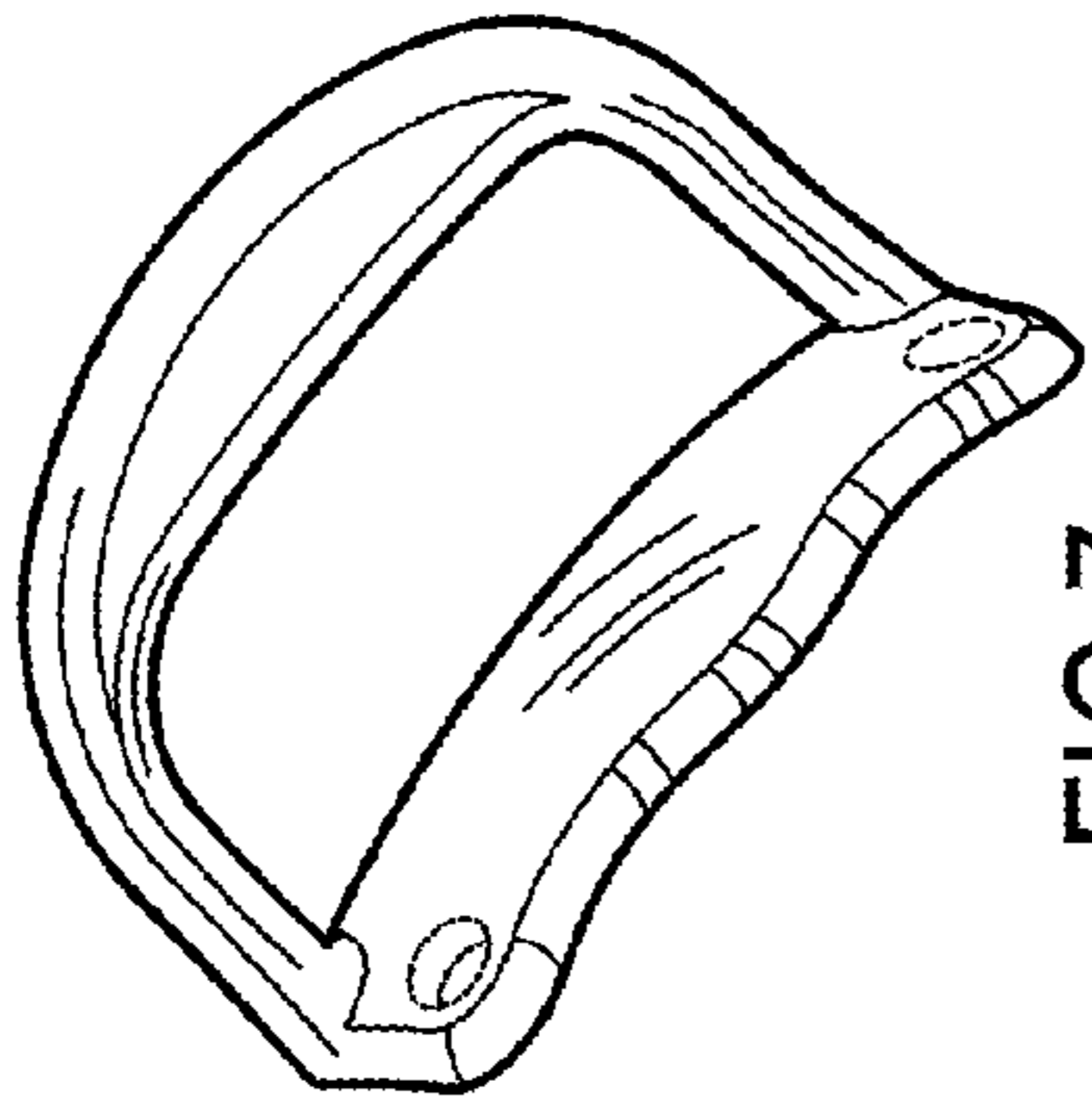

FIG.1

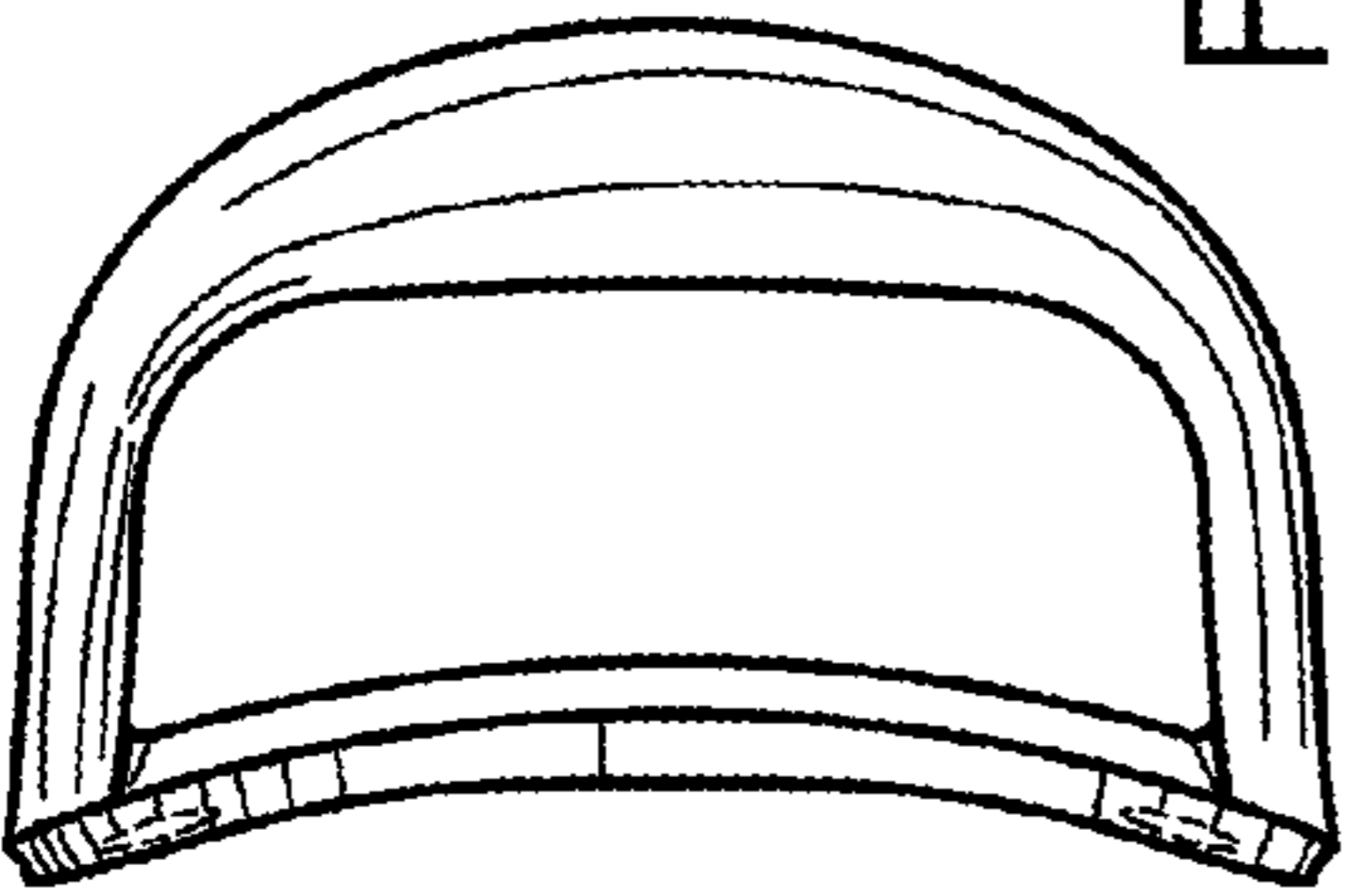

FIG.2

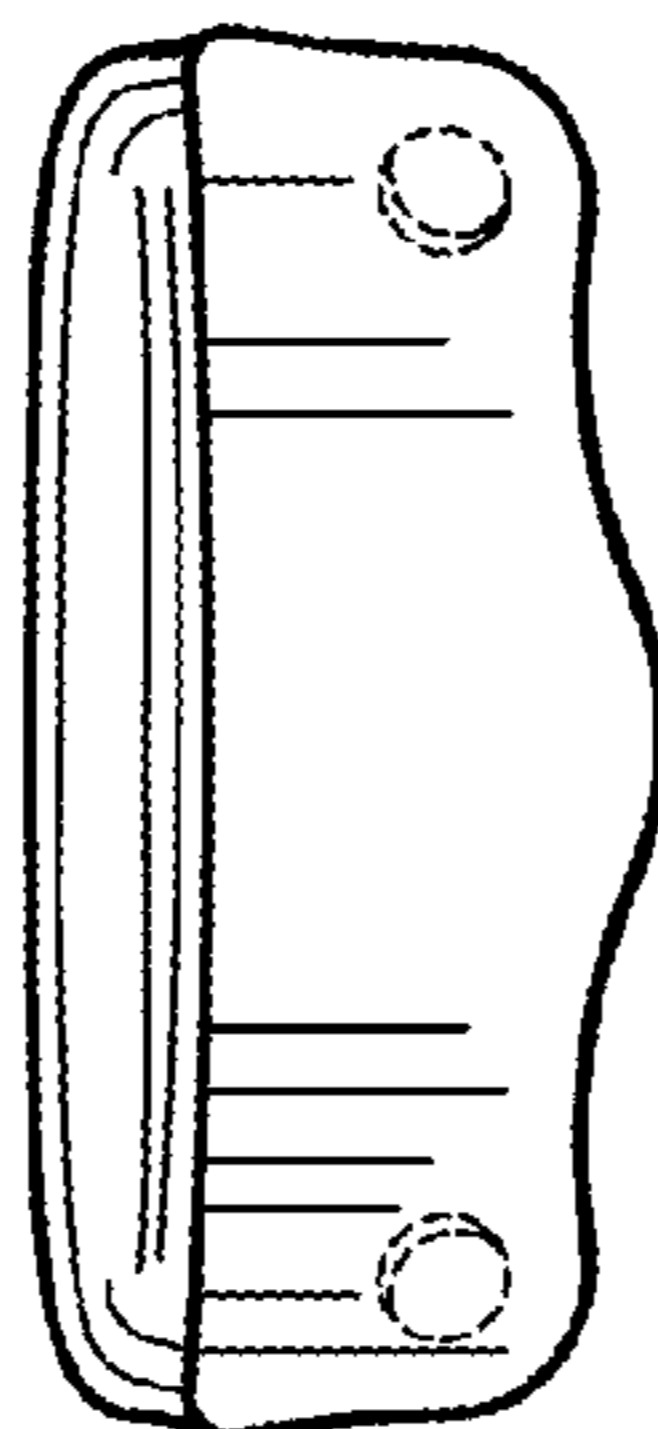

FIG.3

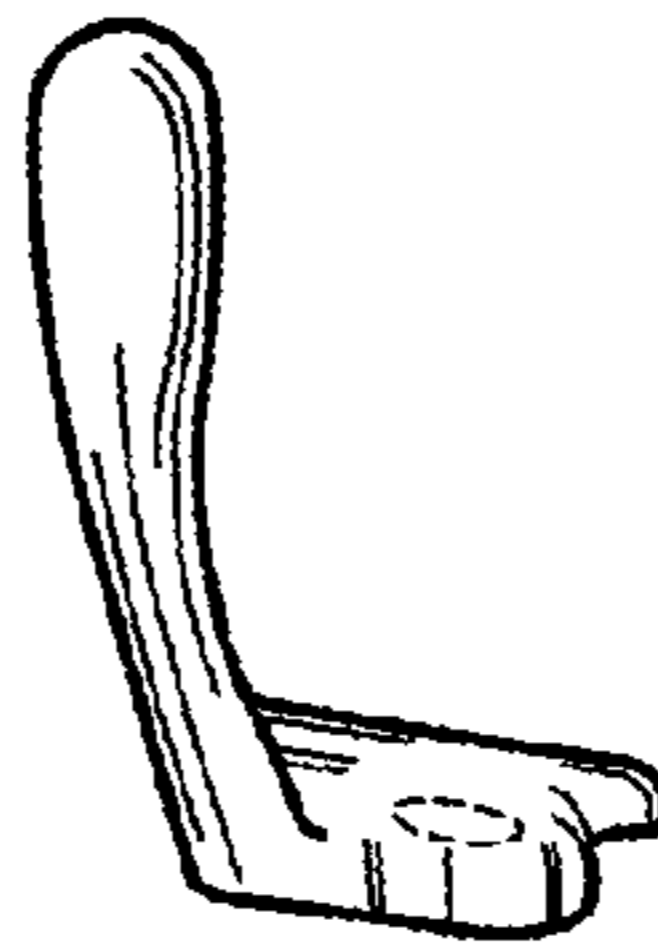

FIG.4



FIG.5

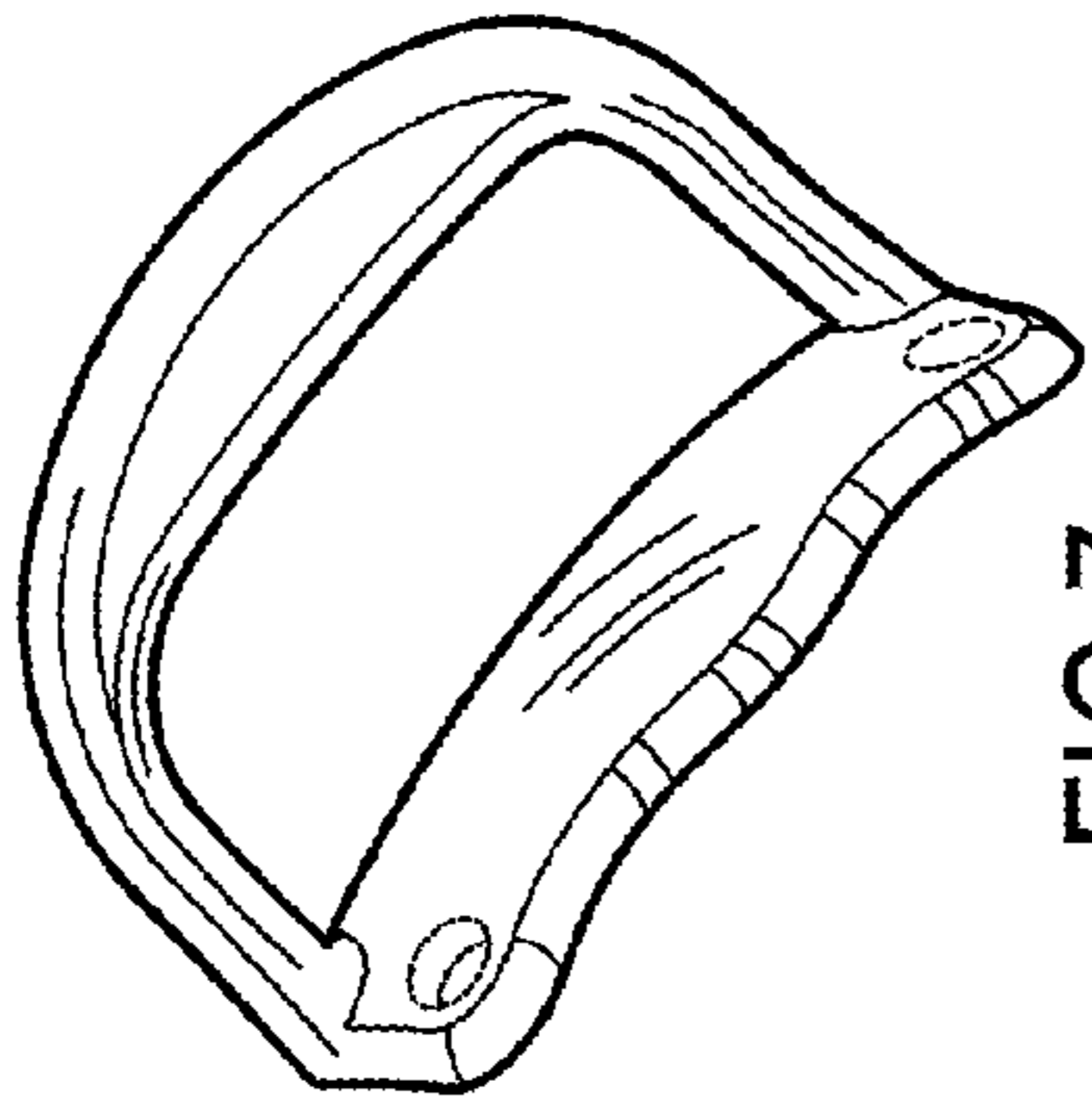

FIG.6

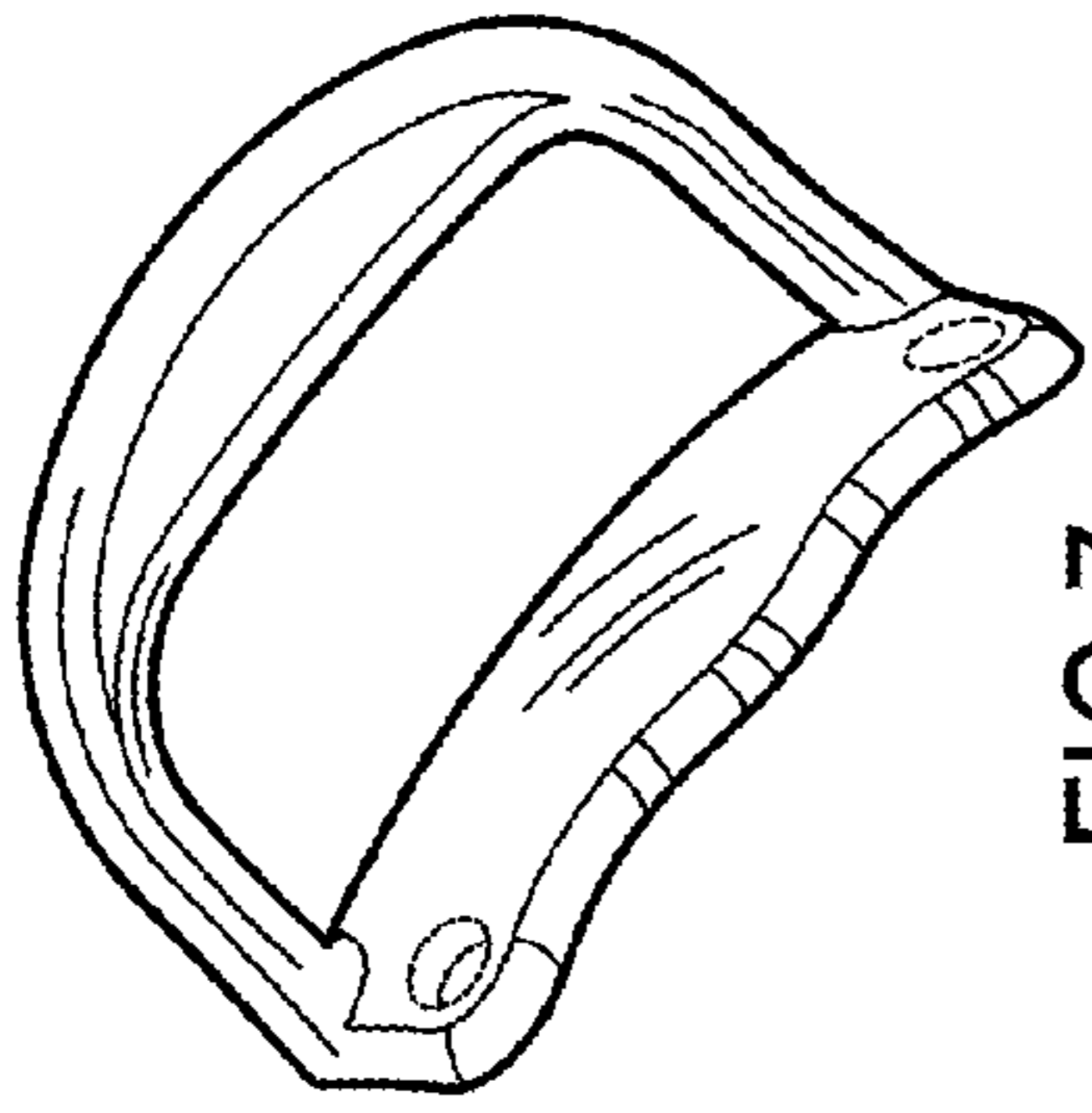

FIG.7

FIG.5