



US00D592425S

(12) **United States Design Patent**
Low

(10) **Patent No.:** **US D592,425 S**

(45) **Date of Patent:** **** May 19, 2009**

(54) **FLOWER POT-STABILIZING DEVICE WITH HANDLES**

(76) Inventor: **Bobbi C. Low**, 4265 Bower La.,
Winston-Salem, NC (US) 27104

(**) Term: **14 Years**

(21) Appl. No.: **29/262,691**

(22) Filed: **Jul. 10, 2006**

(51) **LOC (9) Cl.** **06-04**

(52) **U.S. Cl.** **D6/462**

(58) **Field of Classification Search** D6/462,
D6/458, 499, 403, 487, 556, 449, 480; 47/39,
47/45, 41.01; 220/737, 743; 215/395; 108/161;
211/71.01, 85.23, 181.1, 33; 248/153, 175;
D11/143, 153, 144, 152; D34/6; D7/704
See application file for complete search history.

(56) **References Cited**

U.S. PATENT DOCUMENTS

343,904 A	6/1886	Jewitt	
1,485,852 A *	3/1924	Jarvis	108/92
D71,175 S *	10/1926	Cartwright	D25/149
1,712,986 A	5/1929	Favata, Jr.	
D87,162 S *	6/1932	Malik	D6/403
2,000,632 A	5/1935	Zingre	
2,203,632 A	6/1940	Munson et al.	
D137,862 S *	5/1944	Conant	D6/462
D193,957 S *	10/1962	Young	D34/6
4,032,097 A	6/1977	Dwyer	
D245,155 S	7/1977	Harshman et al.	
4,068,761 A	1/1978	McCarthy	
D249,432 S	9/1978	Pearce et al.	
D271,831 S	12/1983	McGain	
D303,911 S	10/1989	Saari	
5,199,213 A	4/1993	Krebs et al.	

5,412,905 A *	5/1995	Allison	47/30
D362,762 S *	10/1995	Emalfarb et al.	D6/405
D365,700 S *	1/1996	Lee	D6/403
5,606,824 A	3/1997	Ruibal	
D411,722 S	6/1999	Grimes	
6,050,529 A	4/2000	Lin	
D449,180 S *	10/2001	Blake	D6/403
6,349,502 B1 *	2/2002	Fernandez	47/45
D478,735 S *	8/2003	Sellers	D6/403
D504,789 S *	5/2005	Hayes	D6/403

* cited by examiner

Primary Examiner—Caron Veynar

Assistant Examiner—Abraham Bahta

(74) *Attorney, Agent, or Firm*—Donald R. Schoonover

(57) **CLAIM**

I claim the ornamental design for a flower pot-stabilizing device with handles, as shown and described.

DESCRIPTION

FIG. 1 is a perspective view of a flower pot-stabilizing device with handles showing my new design;

FIG. 2 is a side elevational view thereof;

FIG. 3 is an elevational view of the opposing side thereof;

FIG. 4 is a side elevational view perpendicular to the views of FIGS. 2 and 3, the elevational view of the opposing side being a mirror image thereof;

FIG. 5 is a top plan view thereof;

FIG. 6 is a bottom plan view thereof; and,

FIG. 7 is a reduced perspective view showing the flower pot-stabilizing device with handles in use; the broken lines depict environmental structure for illustrative purposes only and form no part of the claimed design.

1 Claim, 4 Drawing Sheets

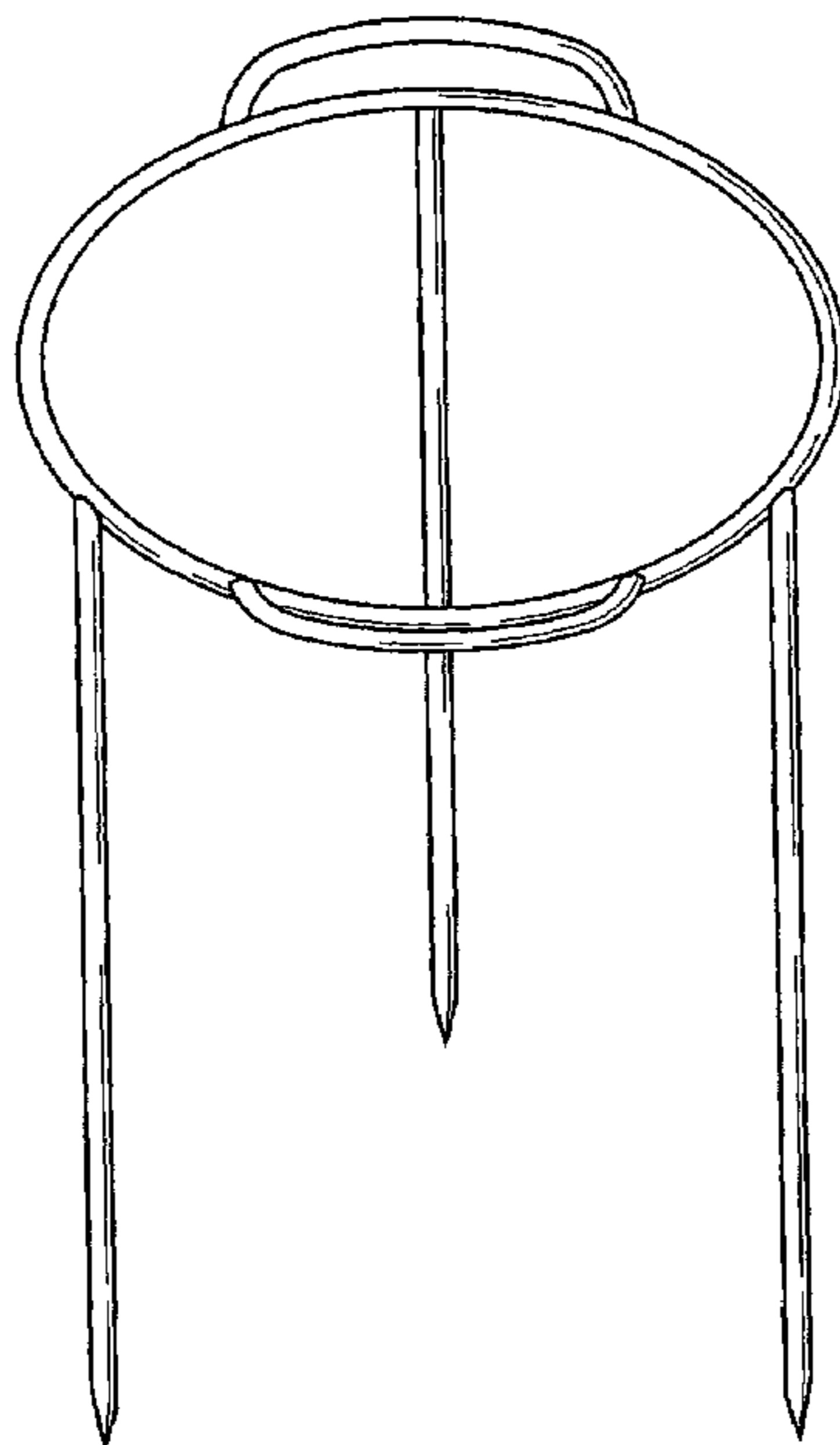

Fig. 1

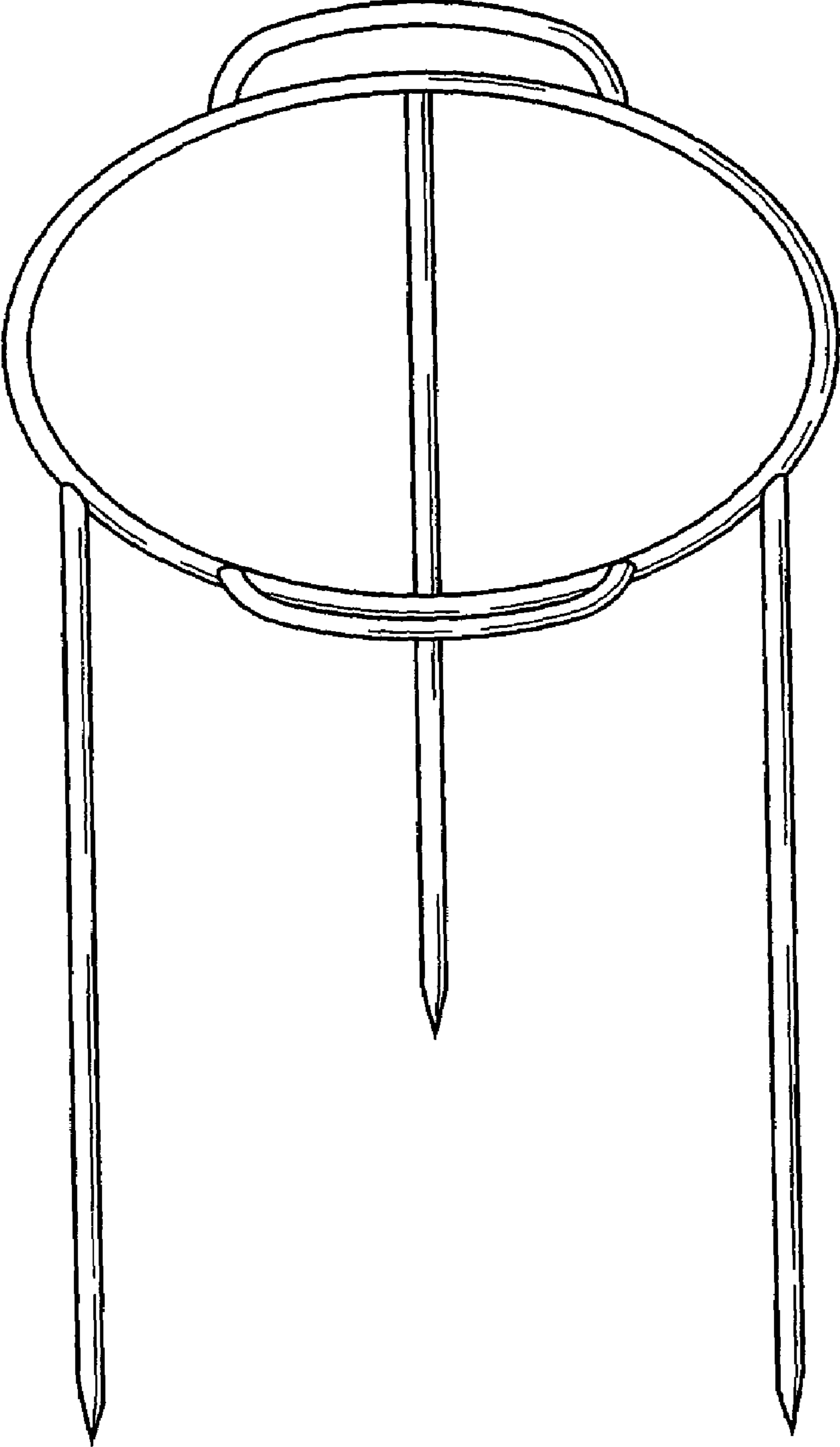

Fig. 3

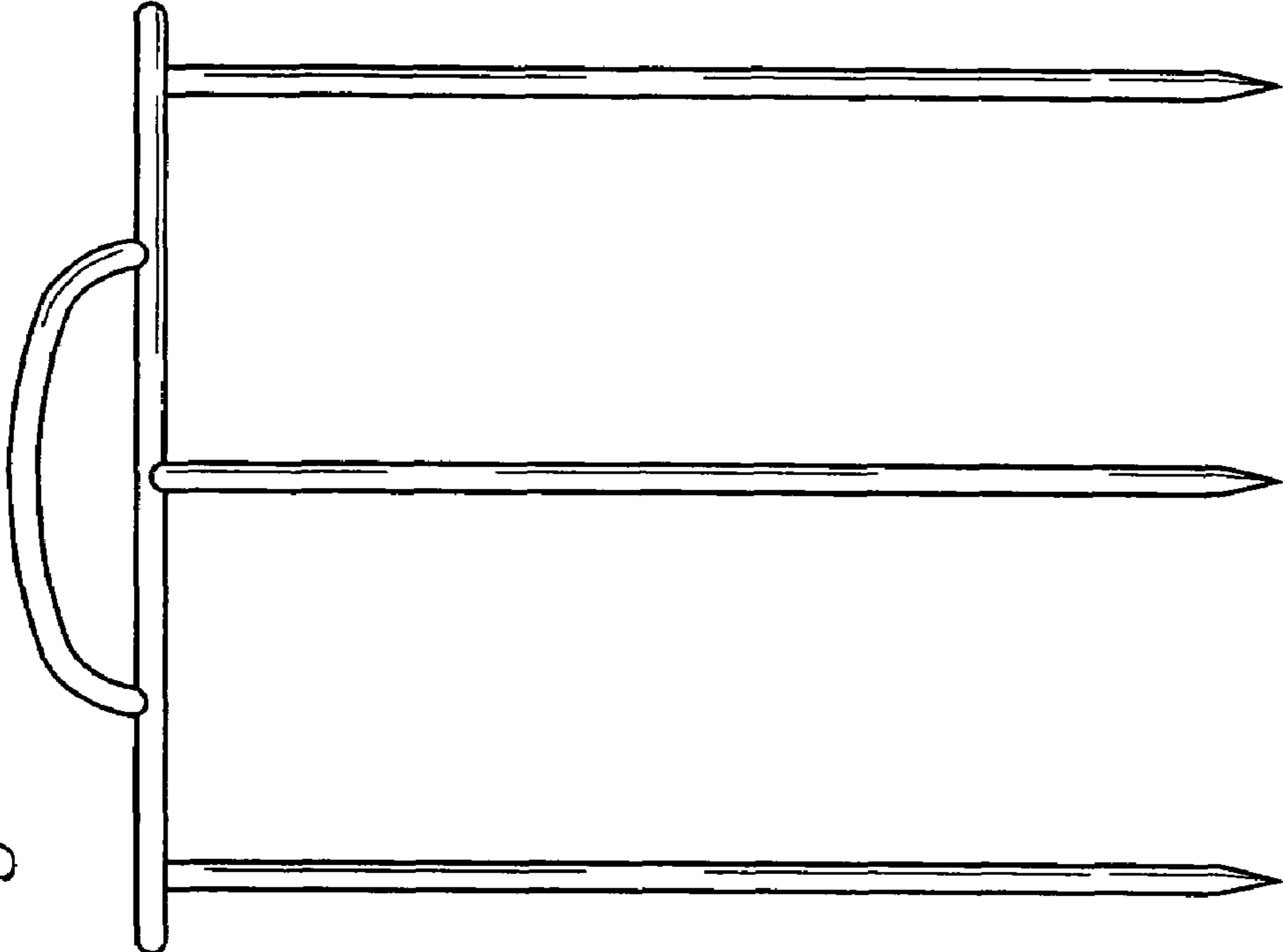
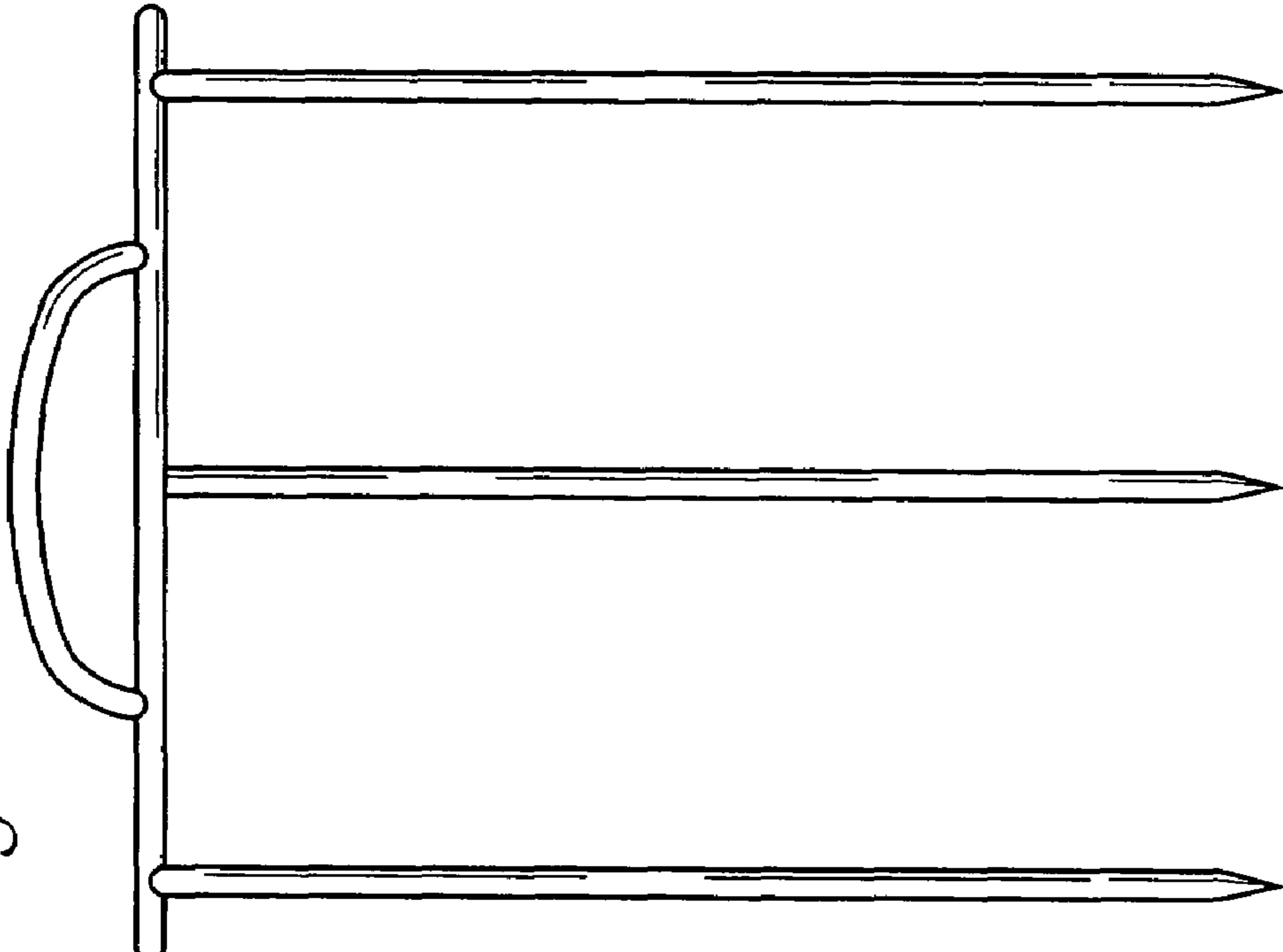

Fig. 2



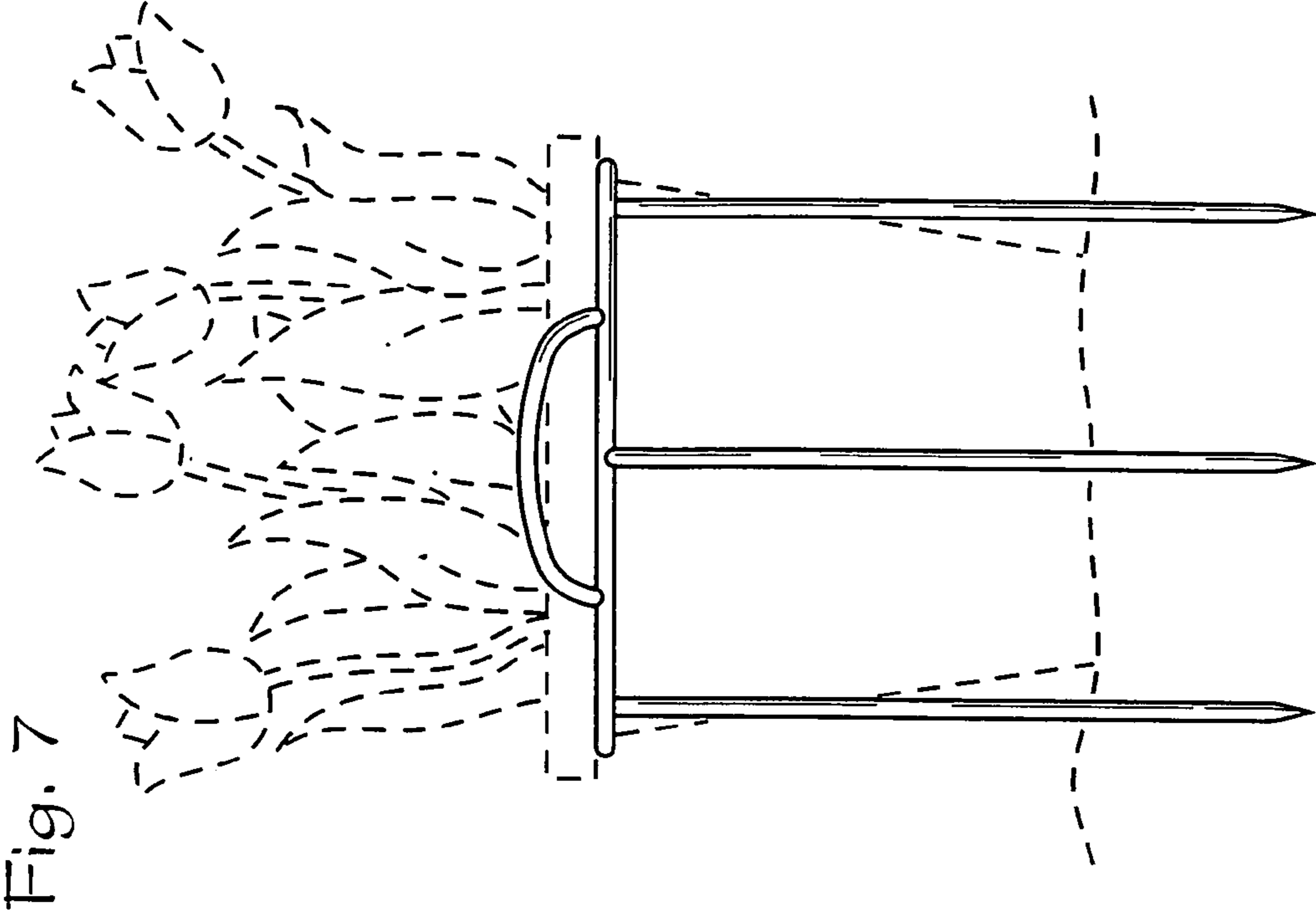

Fig. 7

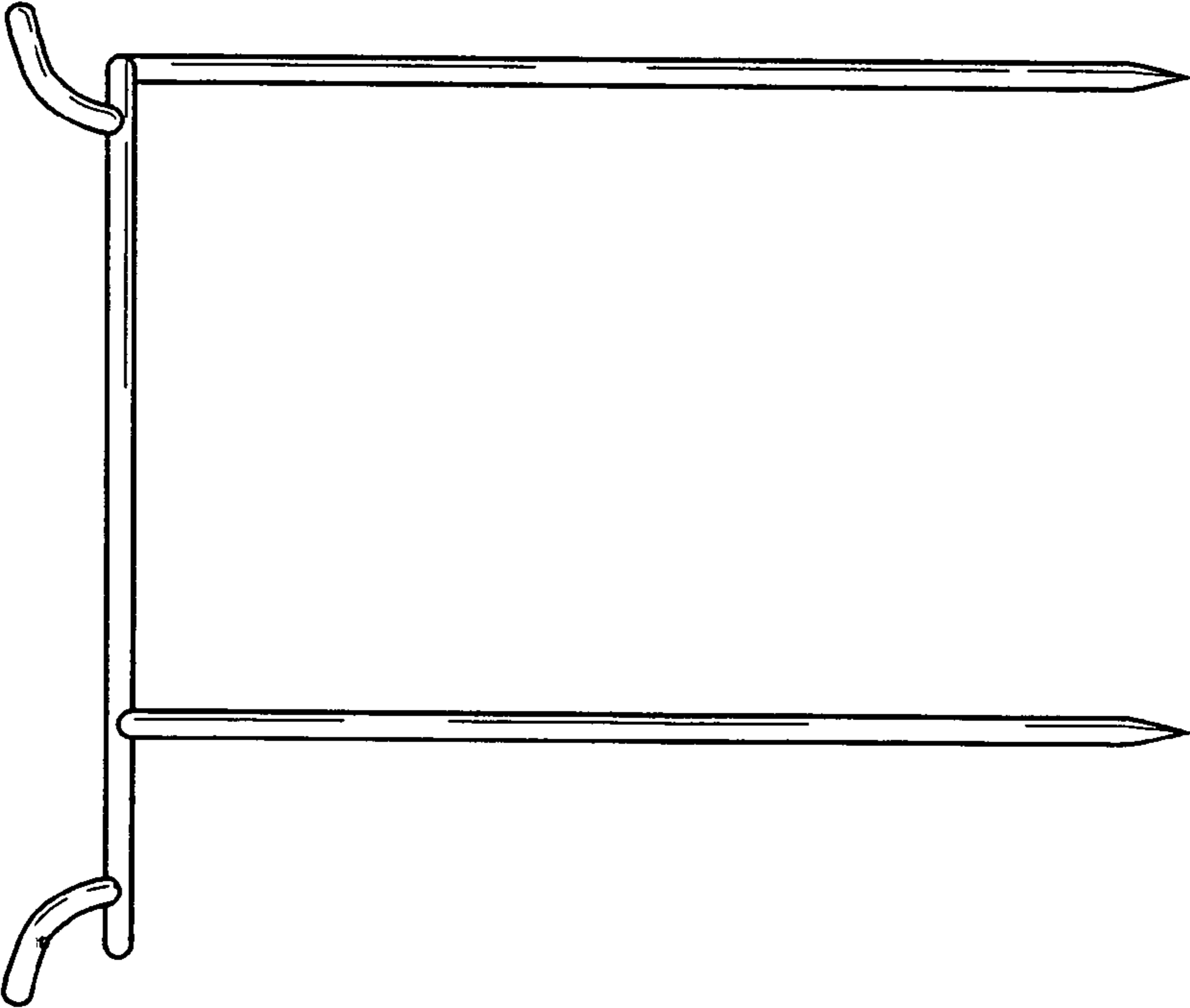

Fig. 4

Fig. 6

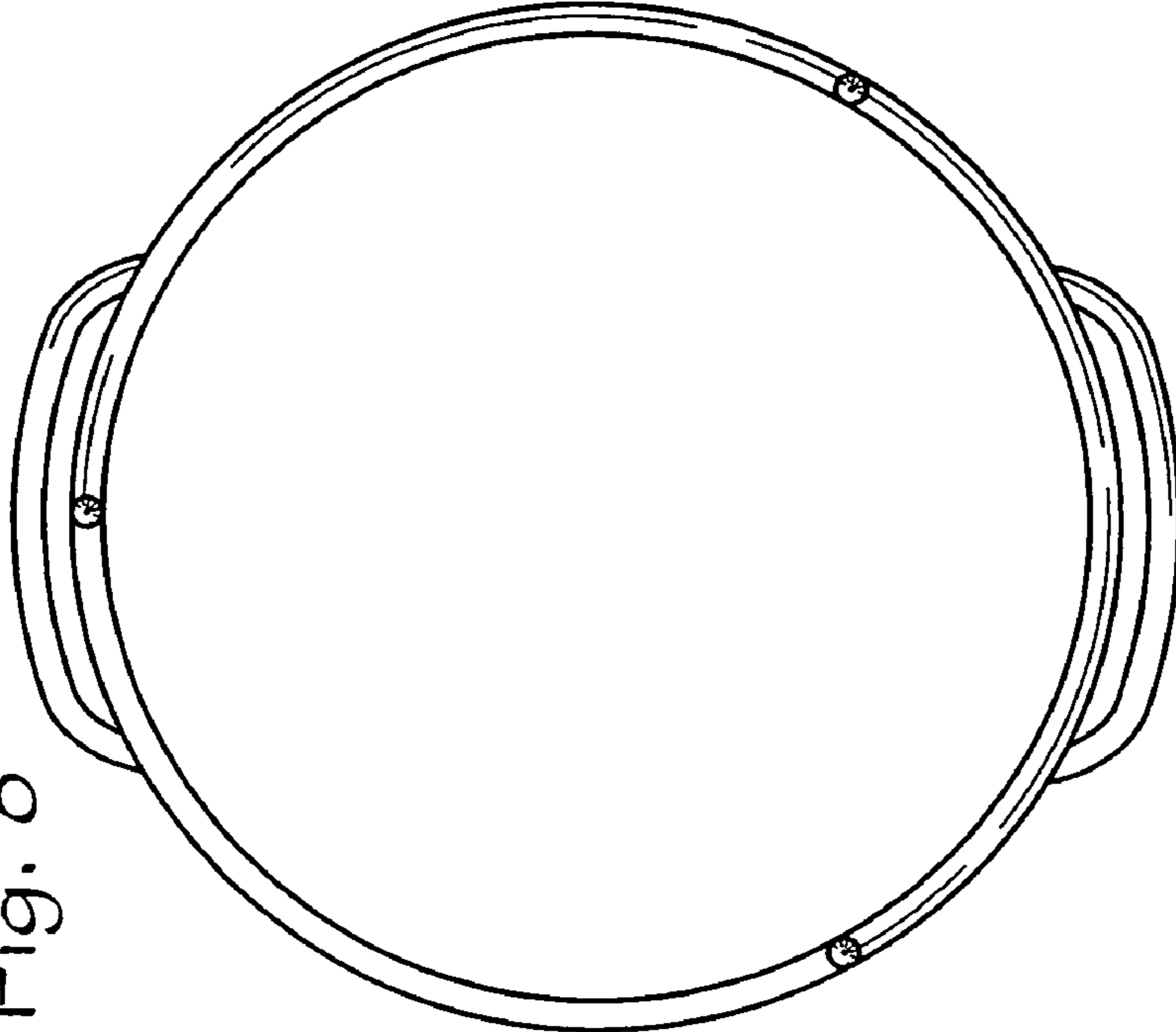

Fig. 5

