

US00D592310S

(12) **United States Design Patent**
Leatt et al.

(10) **Patent No.:** **US D592,310 S**

(45) **Date of Patent:** **** May 12, 2009**

(54) **NECK BRACE**

(75) Inventors: **Christopher James Leatt**, Cape Town (ZA); **Grant Leigh Nelson**, Cape Town (ZA); **Mark Eric Hopkins**, Cape Town (ZA)

(73) Assignee: **Xceed Holdings (Pty) Inc.**, Las Vegas, NV (US)

(**) Term: **14 Years**

(21) Appl. No.: **29/284,258**

(22) Filed: **Sep. 4, 2007**

(51) **LOC (9) Cl.** **24-01**

(52) **U.S. Cl.** **D24/191**

(58) **Field of Classification Search** D24/188-192; 602/4-5, 17-18, 20-21, 62; 128/77, 94, 128/878-880, DIG. 15, DIG. 23; 606/241
See application file for complete search history.

(56) **References Cited**

U.S. PATENT DOCUMENTS

4,827,915 A * 5/1989 Gorsen 602/18
5,010,877 A * 4/1991 Druskoczi 602/18
RE34,714 E * 8/1994 Burns et al. 602/18
5,437,612 A * 8/1995 Moore et al. 602/18

RE35,290 E * 7/1996 Druskoczi 602/18
5,797,713 A * 8/1998 Tweardy et al. 411/339
6,494,854 B1 * 12/2002 Visness et al. 602/18
D542,919 S * 5/2007 Leatt D24/191
D552,742 S * 10/2007 Leatt D24/191

* cited by examiner

Primary Examiner—Robert M Spear

Assistant Examiner—Susan E Krakower

(74) *Attorney, Agent, or Firm*—Connolly Bove Lodge & Hutz LLP; Michael G. Verga

(57) **CLAIM**

The ornamental design for a neck brace, as shown and described.

DESCRIPTION

FIG. 1 is a perspective view according to the invention;
FIG. 2 is a front view thereof;
FIG. 3 is a left side view thereof;
FIG. 4 is a rear view thereof;
FIG. 5 is a top plan view thereof;
FIG. 6 is a right side view thereof; and,
FIG. 7 is a bottom view thereof.

1 Claim, 7 Drawing Sheets

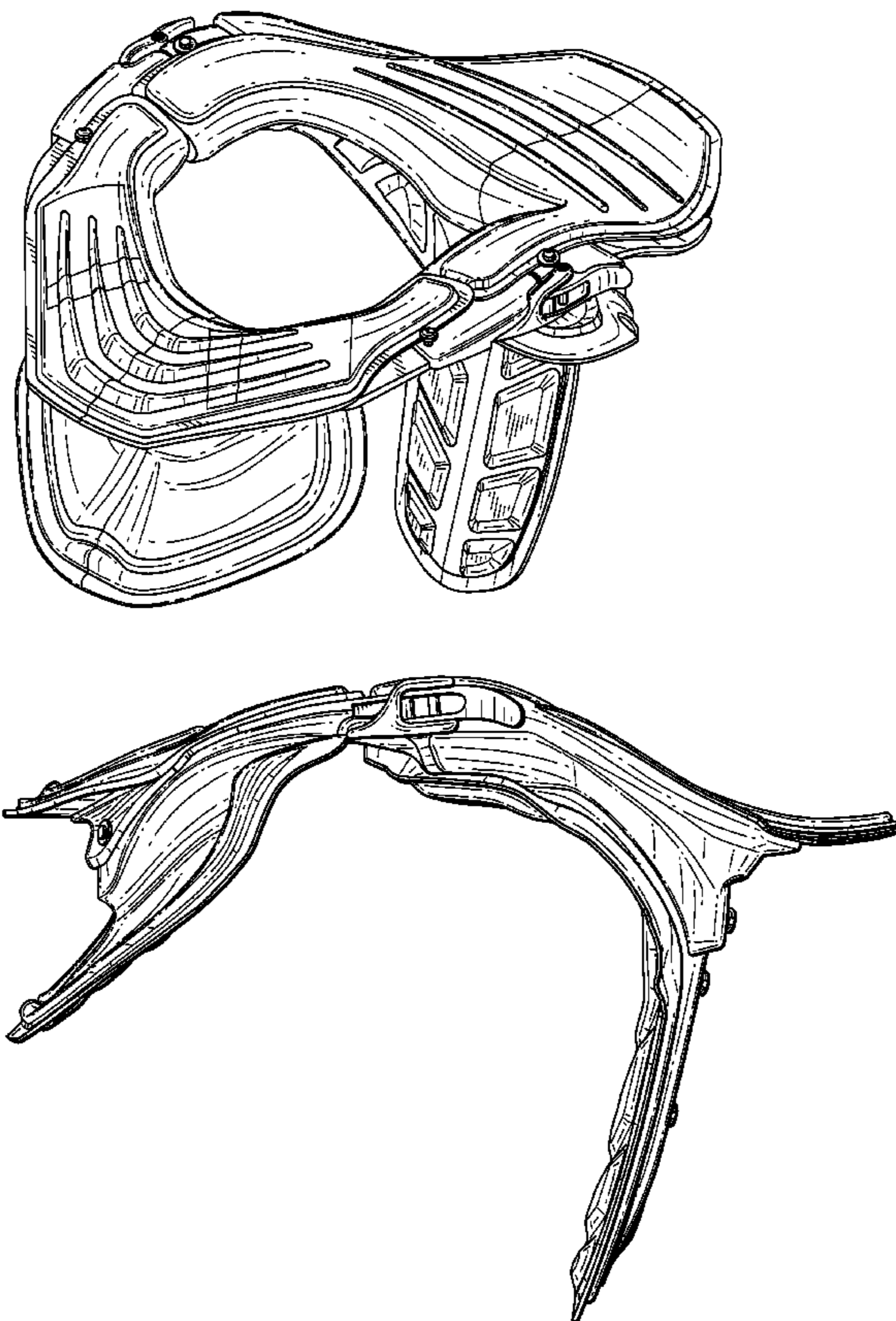

FIG. 1

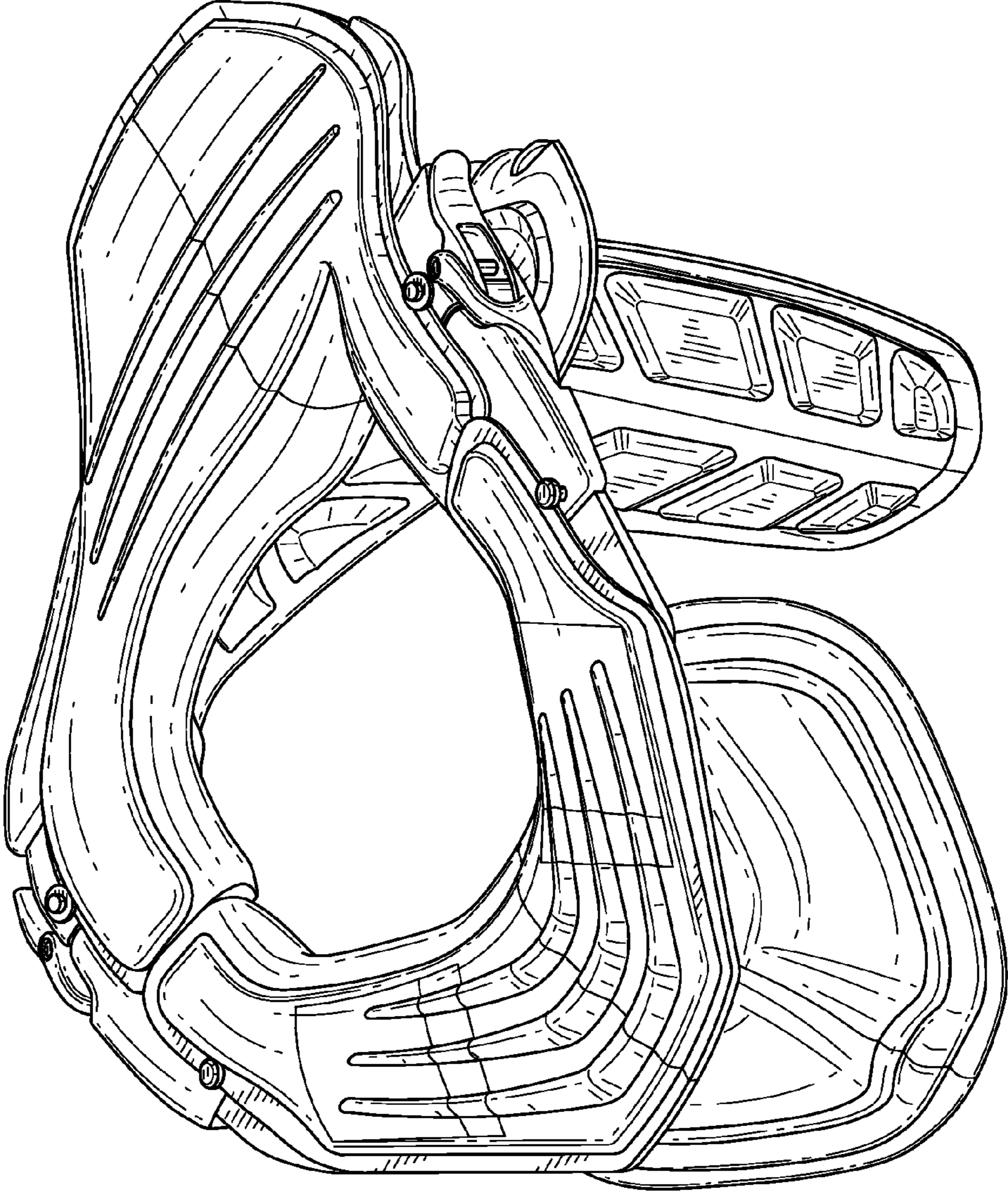

FIG. 2

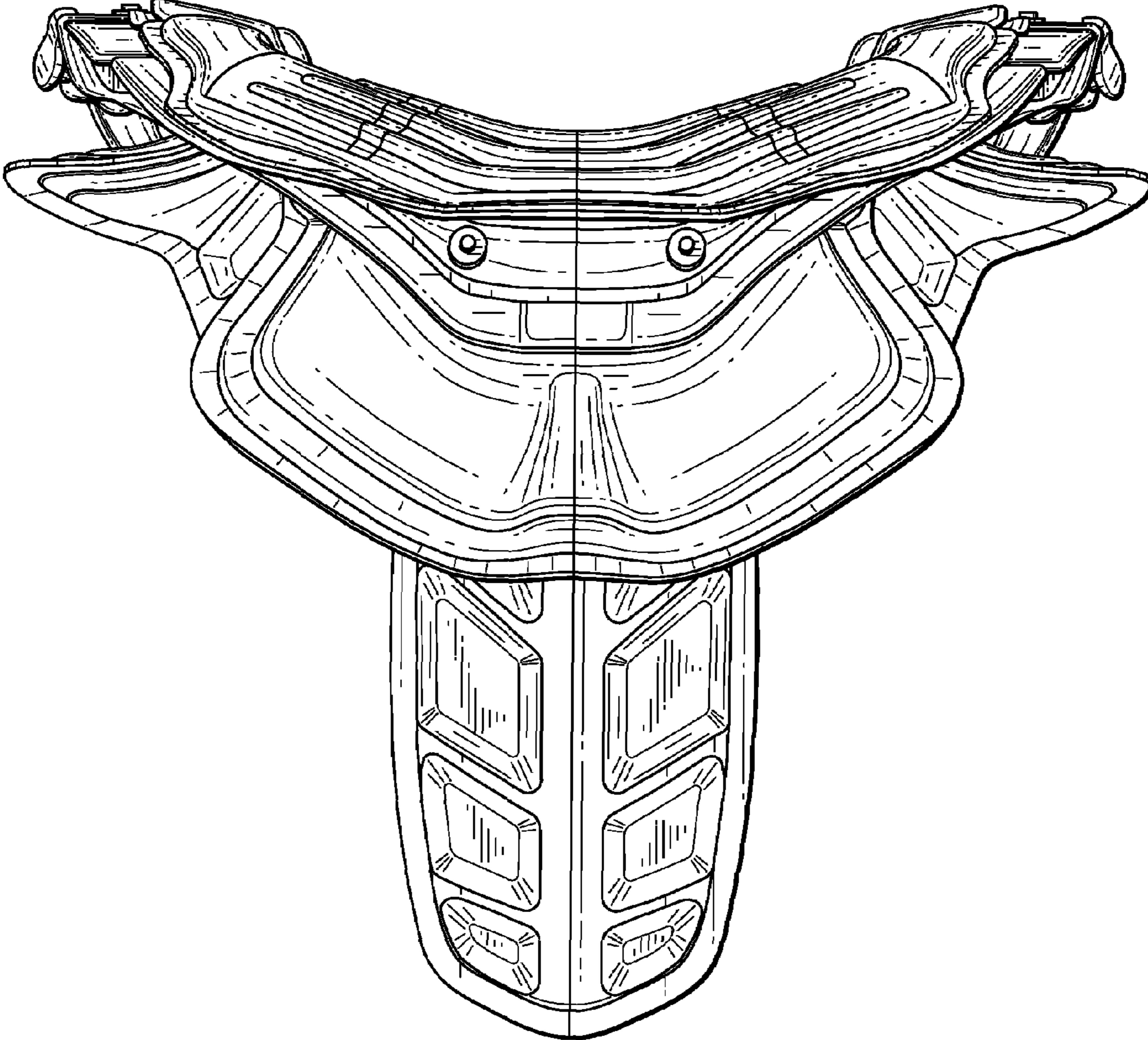

FIG. 3

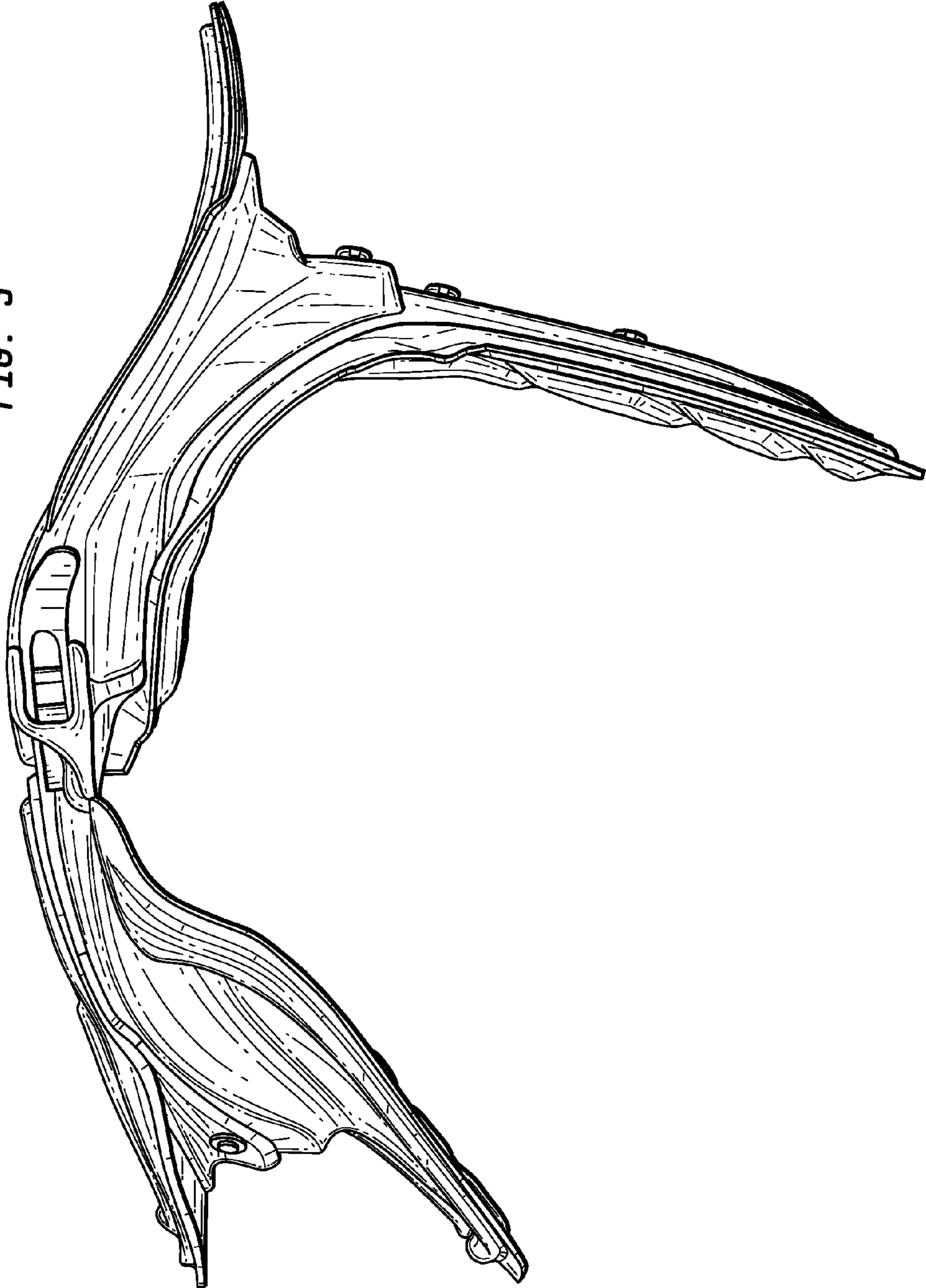

FIG. 4

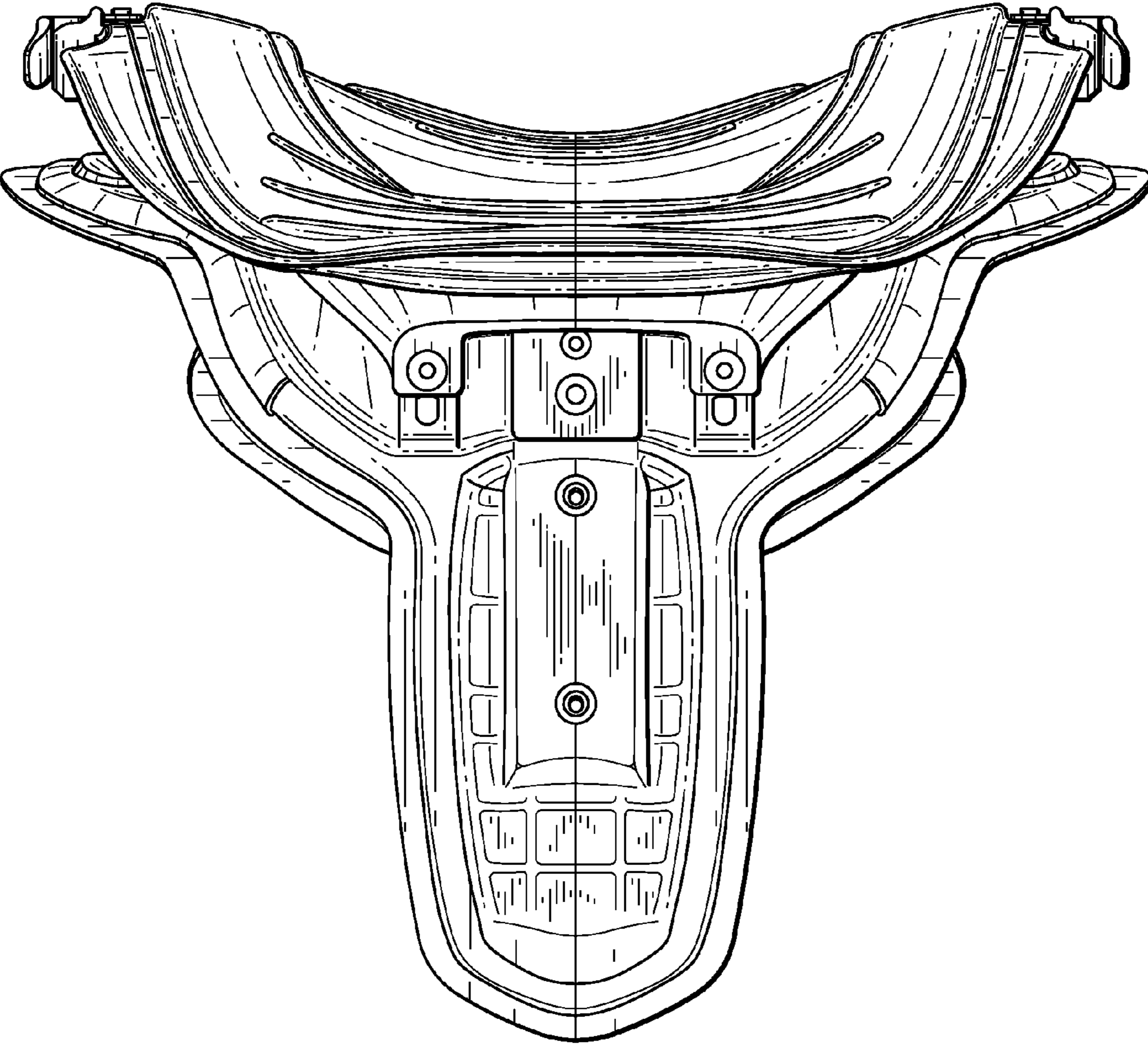
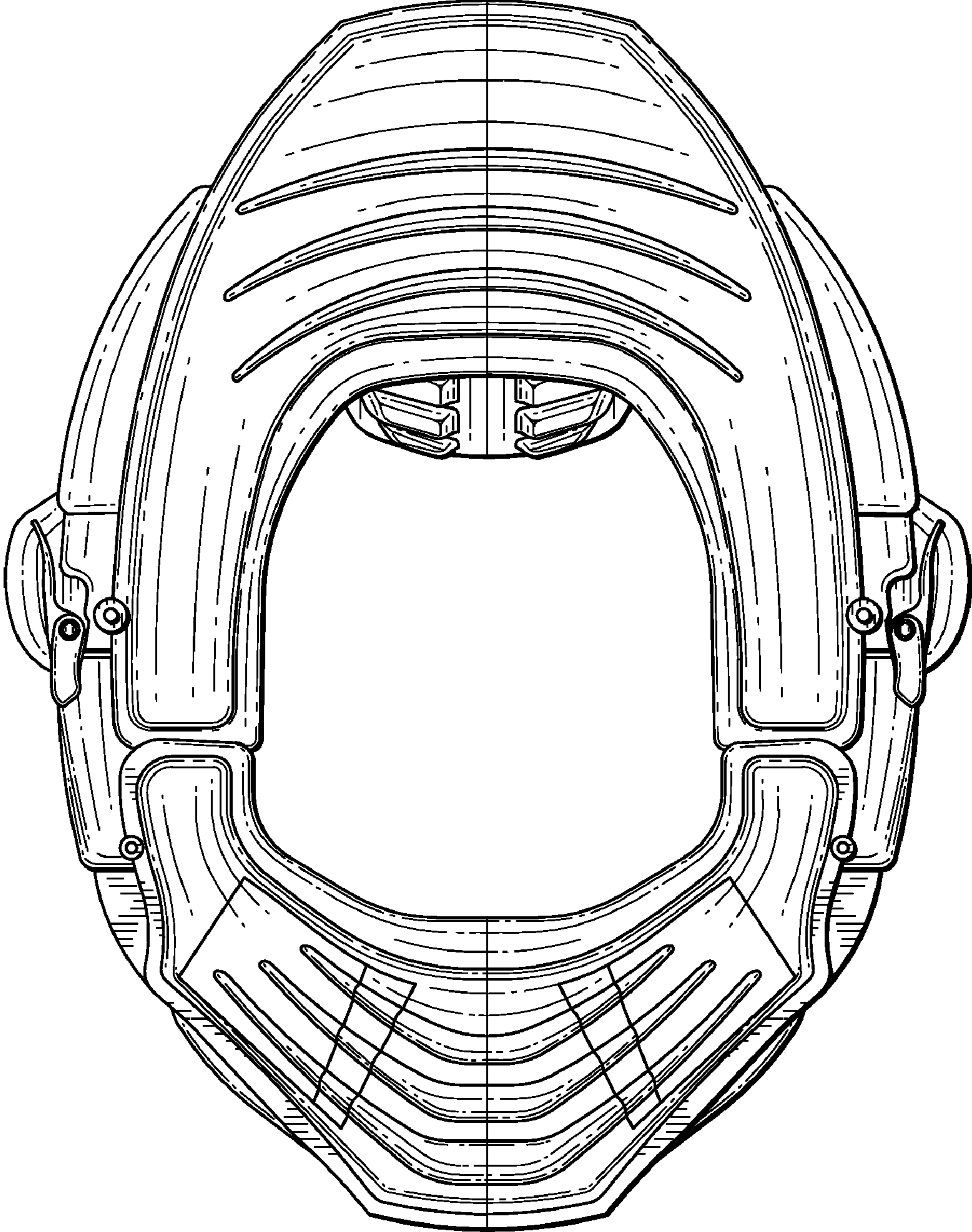

FIG. 5



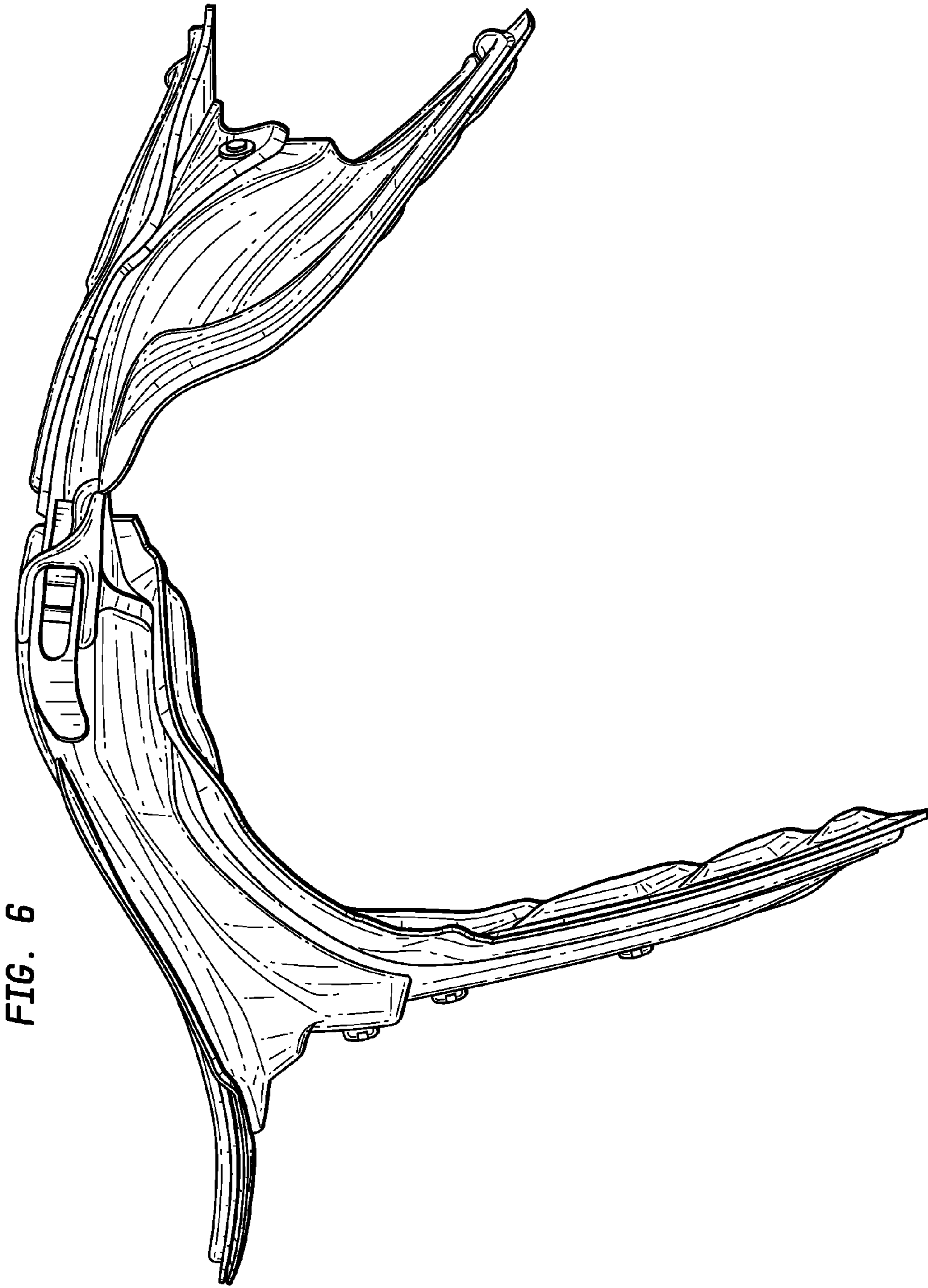

FIG. 6

FIG. 7

