



US00D592275S

(12) **United States Design Patent**
Schoenherr et al.

(10) **Patent No.:** **US D592,275 S**

(45) **Date of Patent:** **** May 12, 2009**

(54) **SHOWERHEAD**

(75) Inventors: **Tom Schoenherr**, Stuttgart (DE);
Fabian Kollmann, Stuttgart (DE)

(73) Assignee: **Hansgrohe AG**, Schiltach (DE)

(**) Term: **14 Years**

(21) Appl. No.: **29/322,137**

(22) Filed: **Jul. 30, 2008**

(30) **Foreign Application Priority Data**

Jan. 31, 2008 (EP) 000870282-0005

(51) **LOC (9) Cl.** **23-01**

(52) **U.S. Cl.** **D23/213**

(58) **Field of Classification Search** D23/213,
D23/223, 229-230; 239/282-283, 460, 462
See application file for complete search history.

(56) **References Cited**

U.S. PATENT DOCUMENTS

D475,119 S * 5/2003 Colligan et al. D23/213
D531,262 S * 10/2006 Tse D23/213
D559,953 S * 1/2008 Bickler et al. D23/229

OTHER PUBLICATIONS

Brochure—Alea Estratto Programma Doccia, 2 pgs., Alea sr.l.,
Vercelli, Italy (at least as early as Feb. 28, 2006).

Brochure—bongio catalog, 3 pgs., Bongio srl, San Maurizio
d’Opaglio, Italy (at least as early as Sep. 28, 2004).

Brochure—newarc choose your own style, 4 pgs., Ece Armatur
Sanayi ve Ticaret A.S., Samandira, Istanbul (at least as early as Feb.
2006).

* cited by examiner

Primary Examiner—Robin V Webster

(74) *Attorney, Agent, or Firm*—Nirav D. Parikh; Edgar A.
Zarins

(57) **CLAIM**

The ornamental design for a showerhead, as shown and
described.

DESCRIPTION

FIG. 1 is a front perspective view of a showerhead showing
our design;

FIG. 2 is a front elevational view thereof;

FIG. 3 is a rear elevational view thereof;

FIG. 4 is a left side elevational view thereof;

FIG. 5 is a right side elevational view thereof;

FIG. 6 is a top plan view thereof; and,

FIG. 7 is a bottom plan view thereof.

The broken lines in the figures are for the purpose of illus-
trating portions of the showerhead that form no part of the
claimed design.

1 Claim, 7 Drawing Sheets

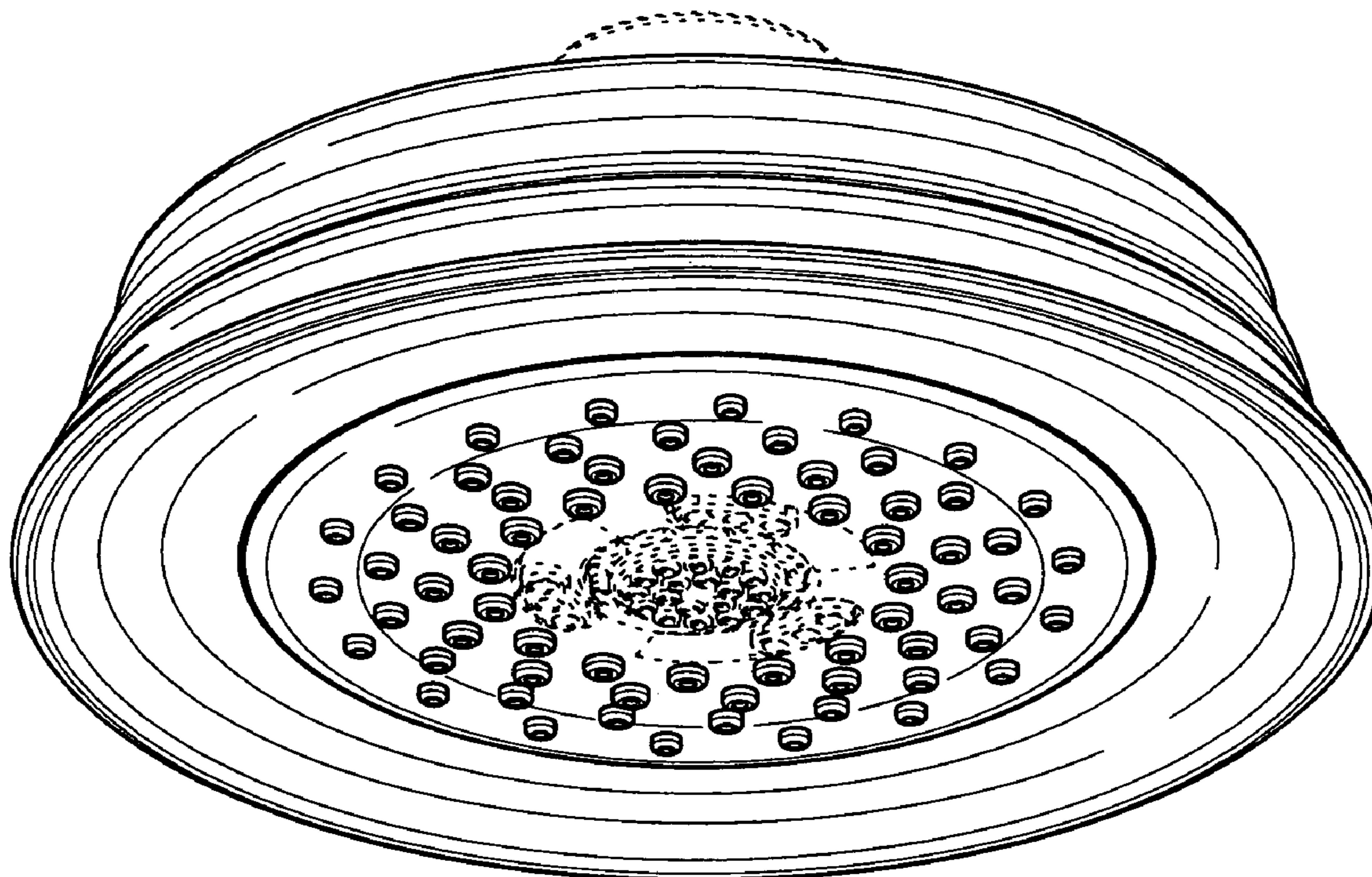

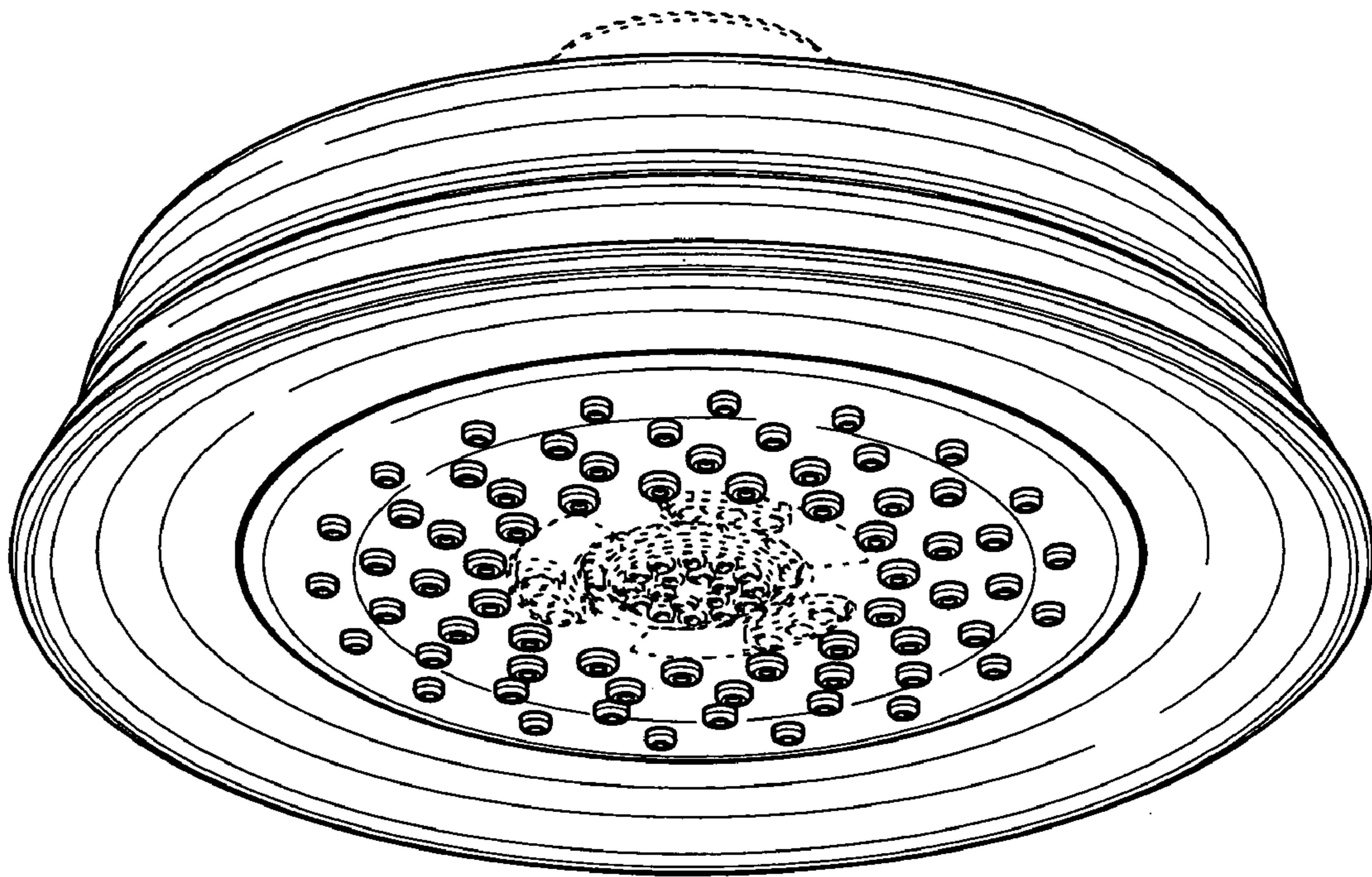

FIG. 1

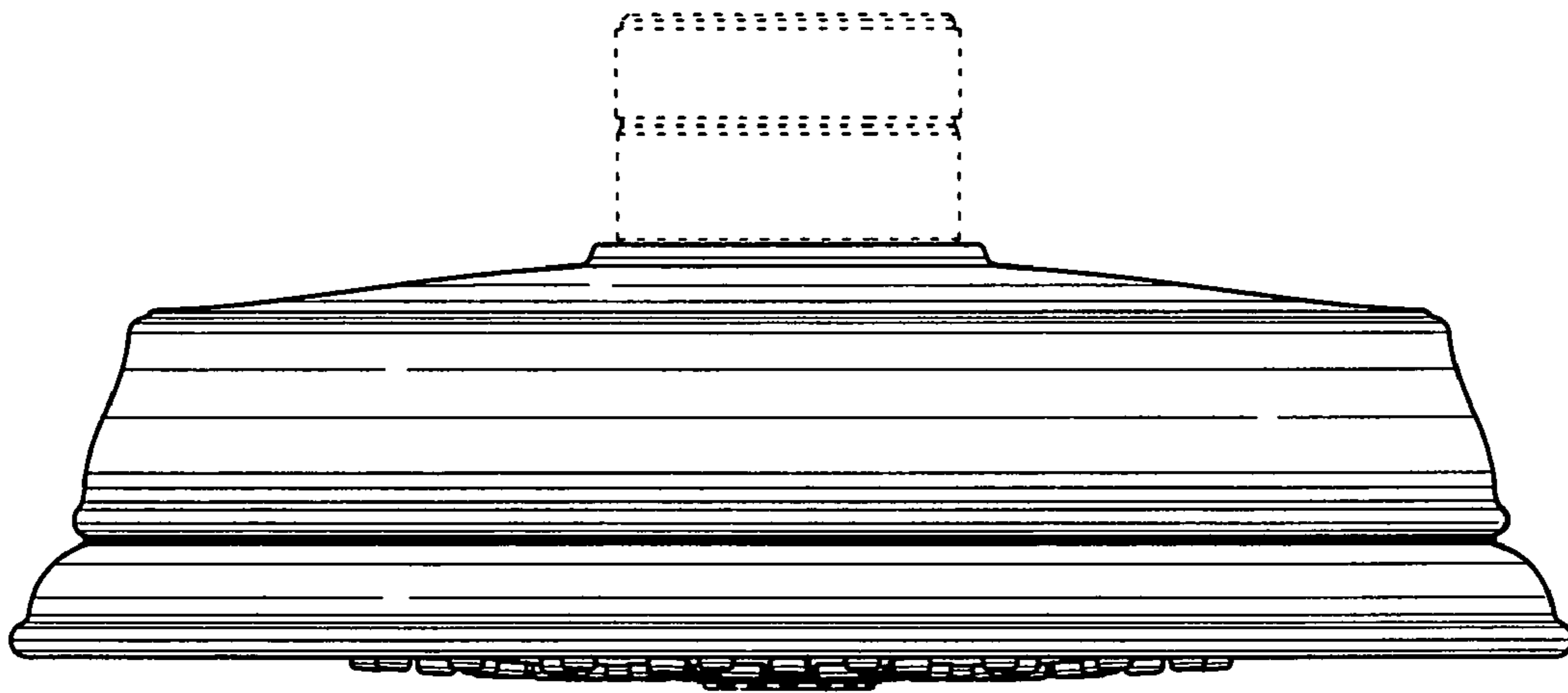

FIG. 2

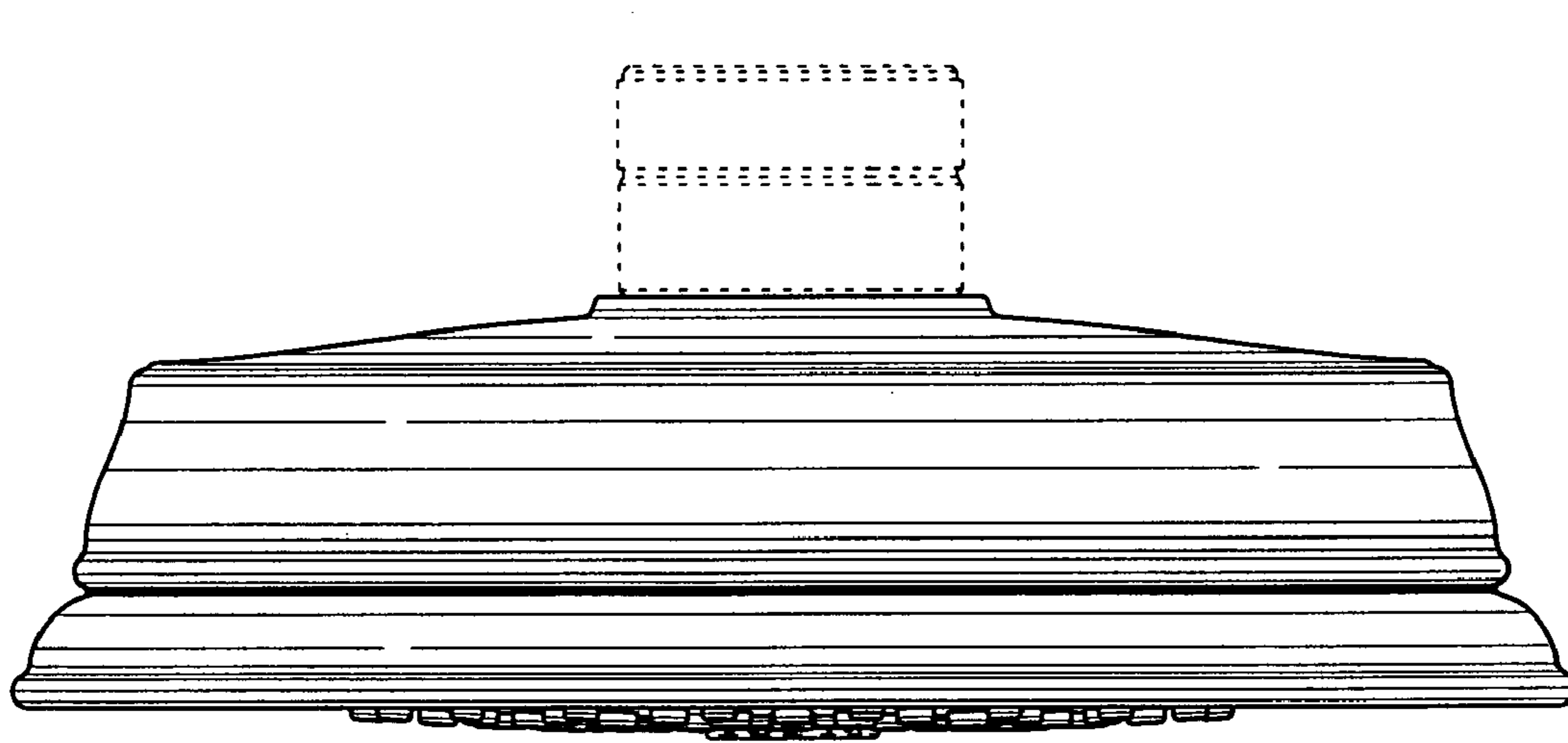

FIG. 3

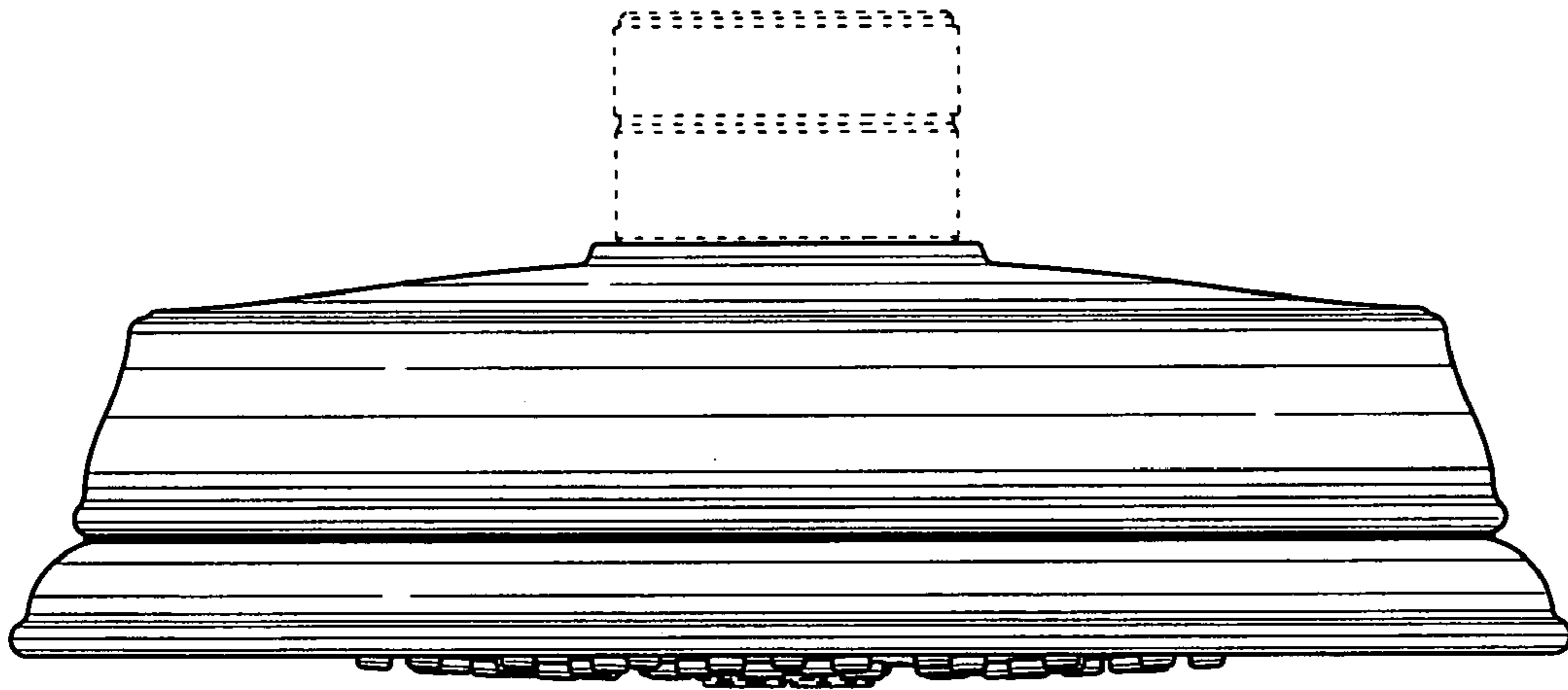

FIG. 4

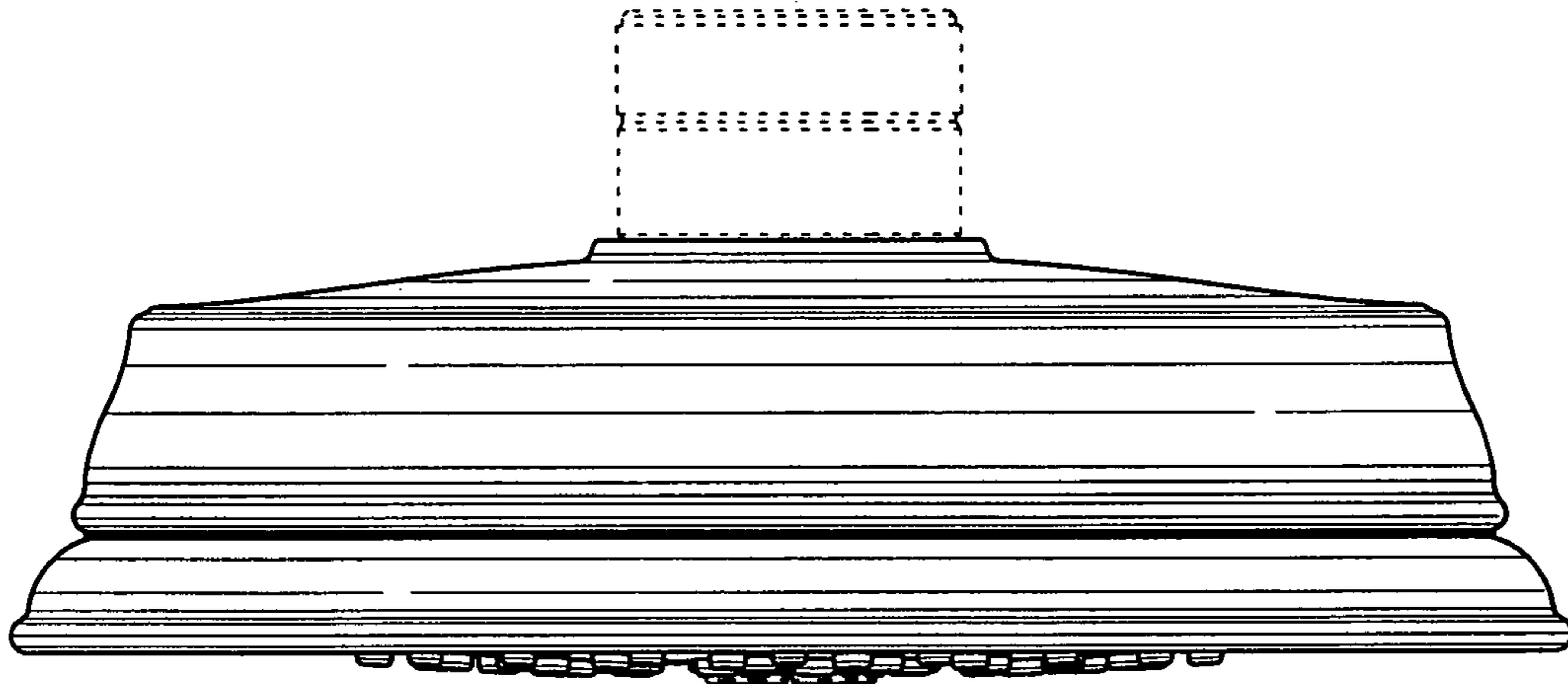

FIG. 5

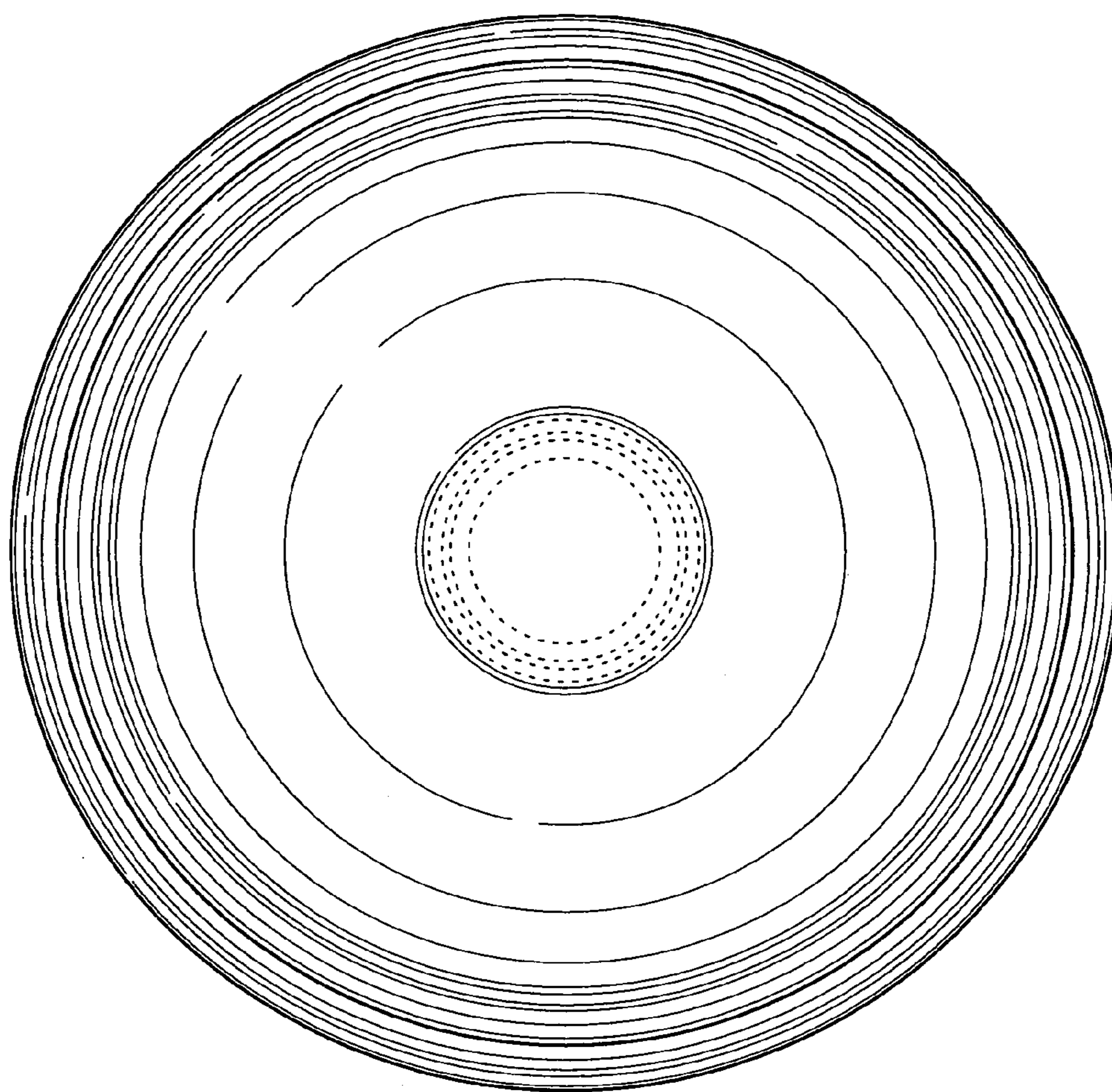

FIG. 6

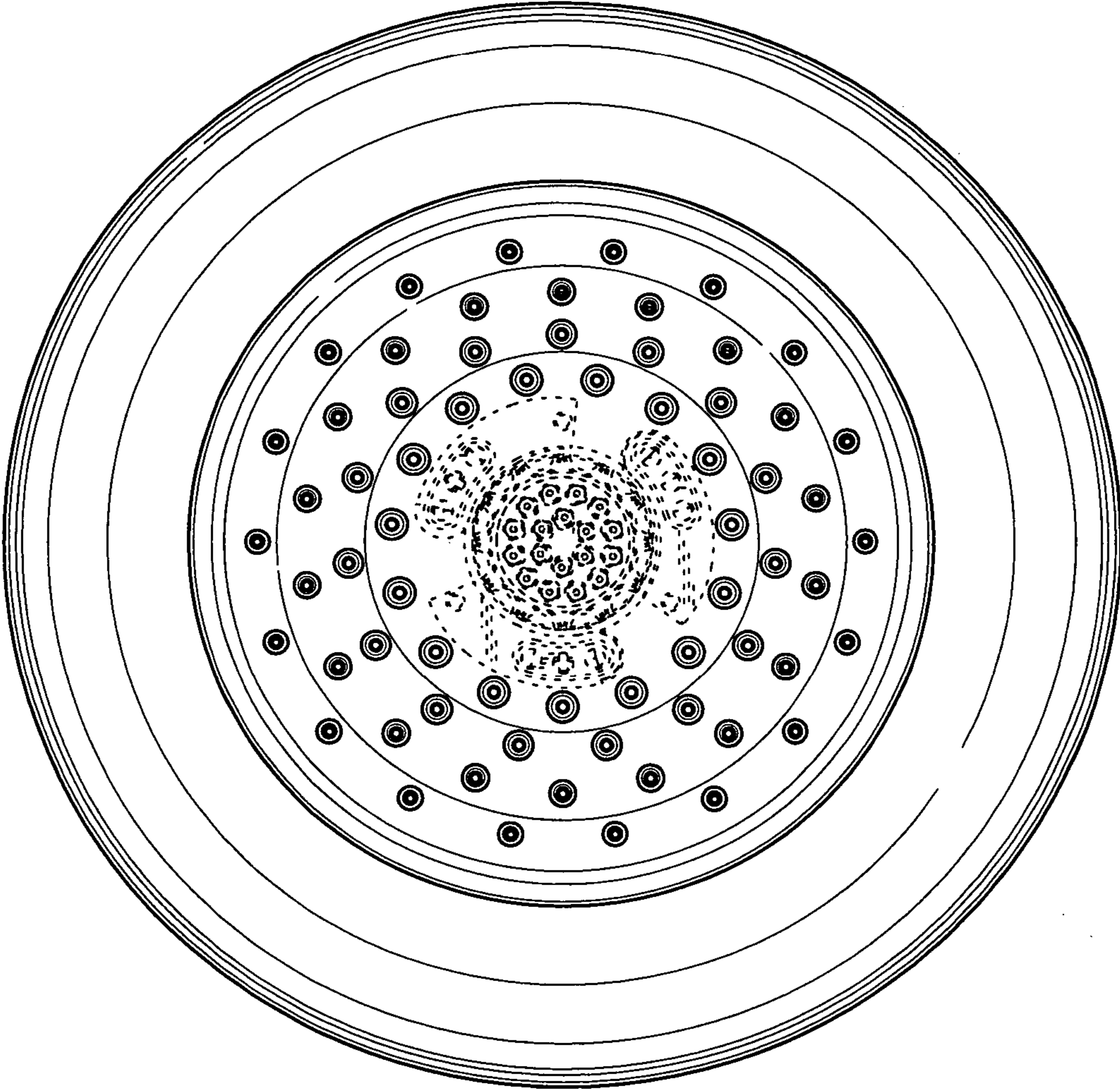

FIG. 7