



US00D592239S

(12) **United States Design Patent**
Gerlier

(10) **Patent No.:** **US D592,239 S**

(45) **Date of Patent:** **** May 12, 2009**

(54) **MONEY STORE**

(75) Inventor: **André Gerlier**, Sciez (FR)

(73) Assignee: **MEL, Inc.**, West Chester, PA (US)

(**) Term: **14 Years**

(21) Appl. No.: **29/252,303**

(22) Filed: **Jan. 20, 2006**

(30) **Foreign Application Priority Data**

Jul. 26, 2005 (EM) 000379383-0003

(51) **LOC (9) Cl.** **18-01**

(52) **U.S. Cl.** **D18/3.3; D18/3.1**

(58) **Field of Classification Search** D18/3.1,
D18/3.2, 5, 12, 46, 47, 50, 54, 56, 57, 59,
D18/99; 101/2, 3.1, 4, 5; 209/534; 235/2,
235/3, 379

See application file for complete search history.

(56) **References Cited**

U.S. PATENT DOCUMENTS

D233,694 S * 11/1974 Tamura et al. D18/3.1
D237,419 S * 10/1975 Lapins D3/282
D245,455 S * 8/1977 Cathey D14/328
D289,582 S * 5/1987 Brush et al. D3/281
D294,597 S * 3/1988 Lanagan D18/3.1
D322,803 S * 12/1991 Irie et al. D18/54
D349,128 S * 7/1994 Akioka et al. D18/46
5,325,970 A * 7/1994 Dillon et al. 206/576

D376,246 S * 12/1996 Sugawara et al. D99/28
D481,850 S * 11/2003 Magee et al. D99/28
D482,056 S * 11/2003 Bergeron et al. D18/3.3
D482,840 S * 11/2003 Magee et al. D99/28

* cited by examiner

Primary Examiner—Stella M Reid

Assistant Examiner—Elizabeth J Oswecki

(74) *Attorney, Agent, or Firm*—Fish & Richardson P.C.

(57) **CLAIM**

The ornamental design for a money store, as shown and described.

DESCRIPTION

FIG. 1 is a top plan view of a money store showing my new design,

FIG. 2 is a bottom plan view thereof,

FIG. 3 is a front elevational view thereof,

FIG. 4 is an isometric view thereof,

FIG. 5 is a left side elevational view thereof,

FIG. 6 is a right side elevational view thereof; and,

FIG. 7 is a back elevational view thereof.

The claimed design is for the front portion of the money store.

The broken line immediately adjacent to the shaded area represents the bounds of the claimed design. All other broken lines showing of a money store is included for the purpose of illustrating only and forms no part of the claimed design.

1 Claim, 7 Drawing Sheets

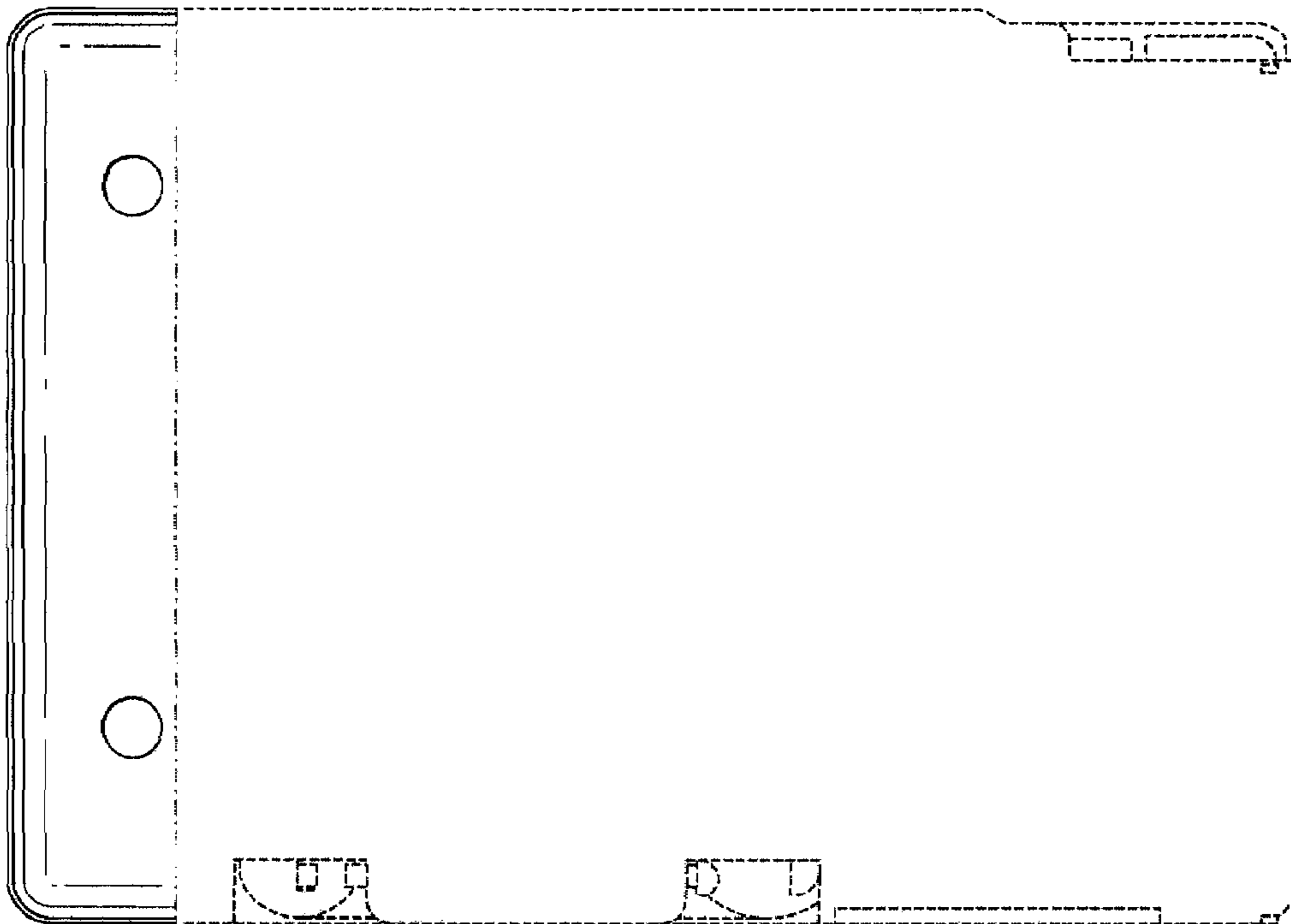

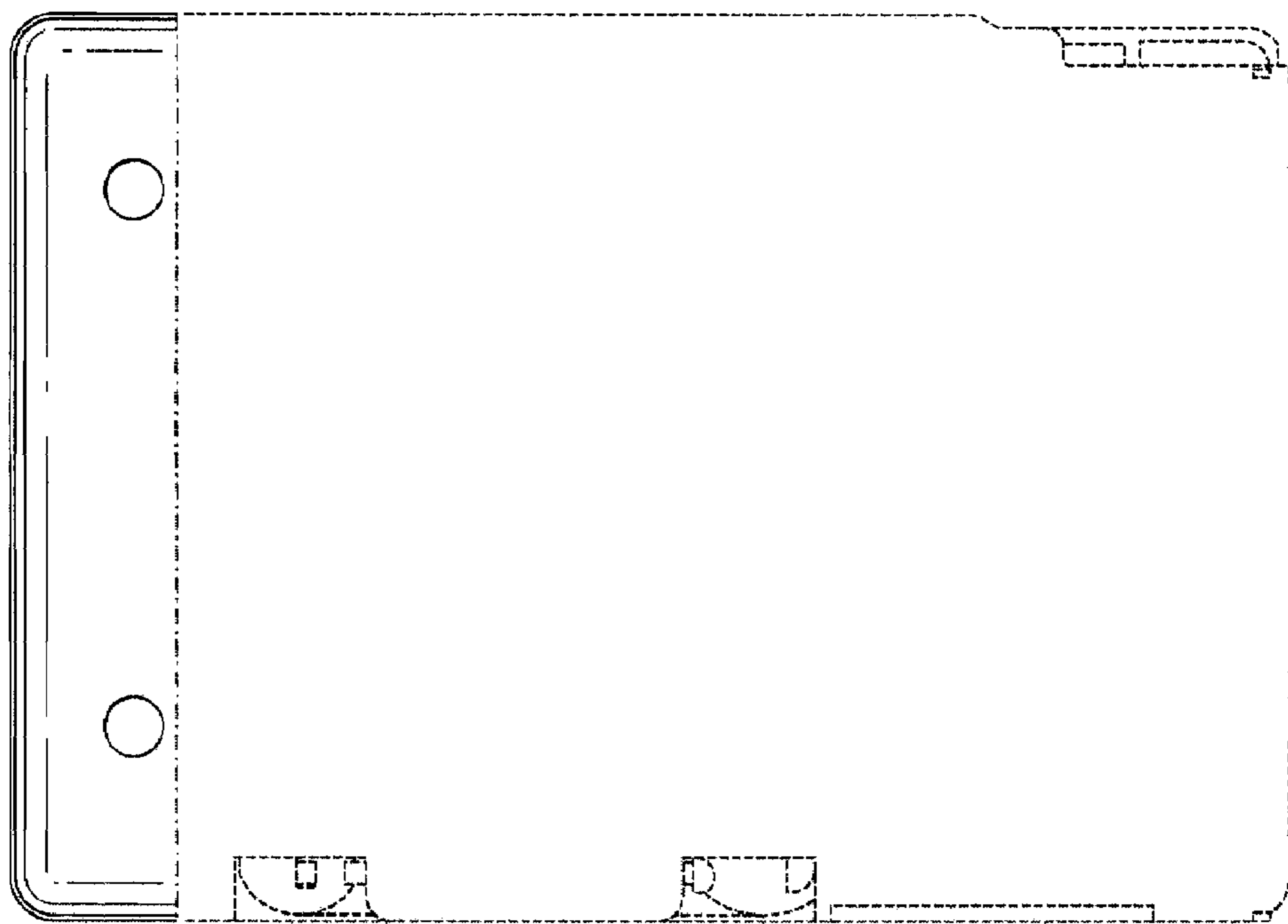

FIG. 1

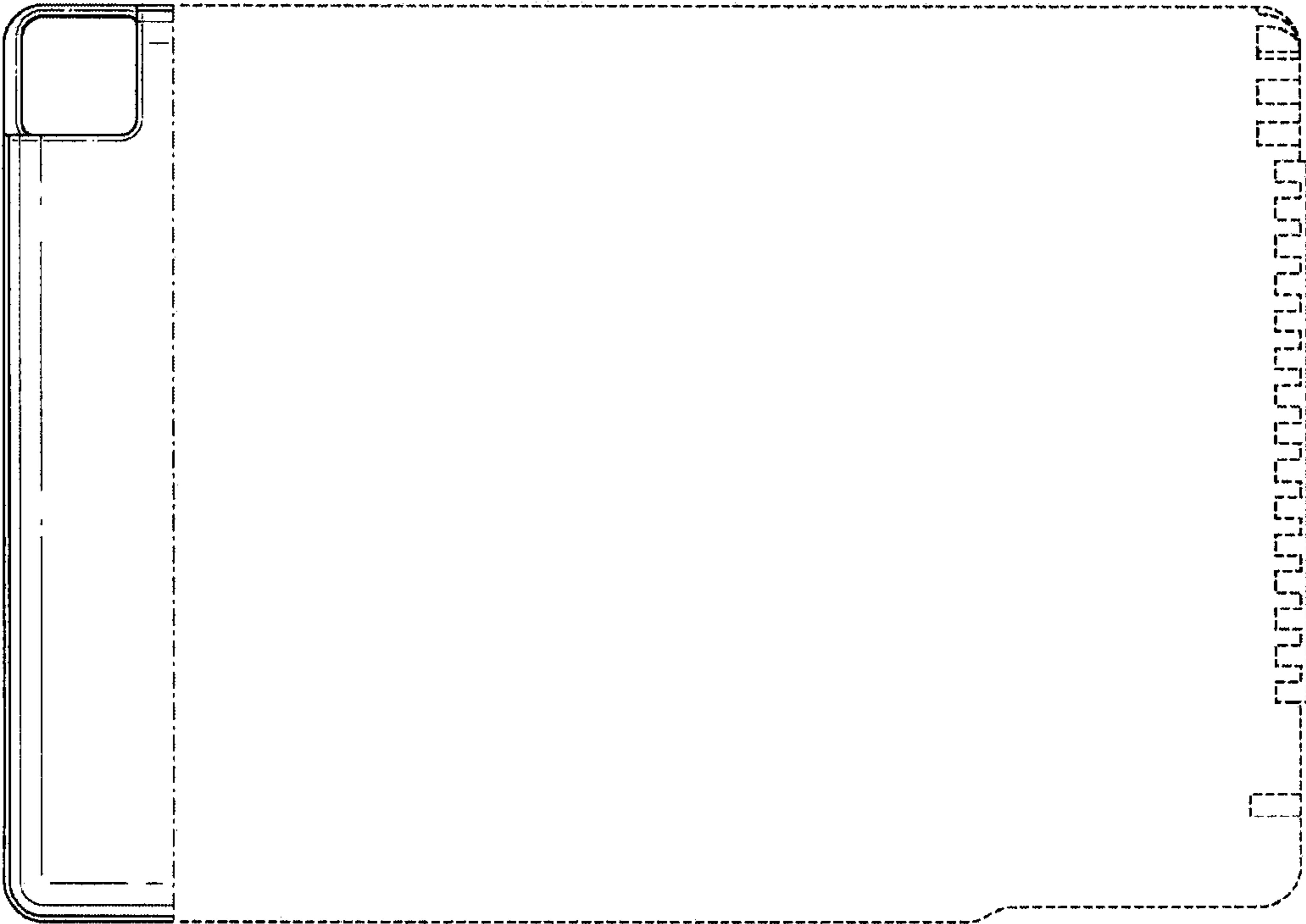

FIG. 2

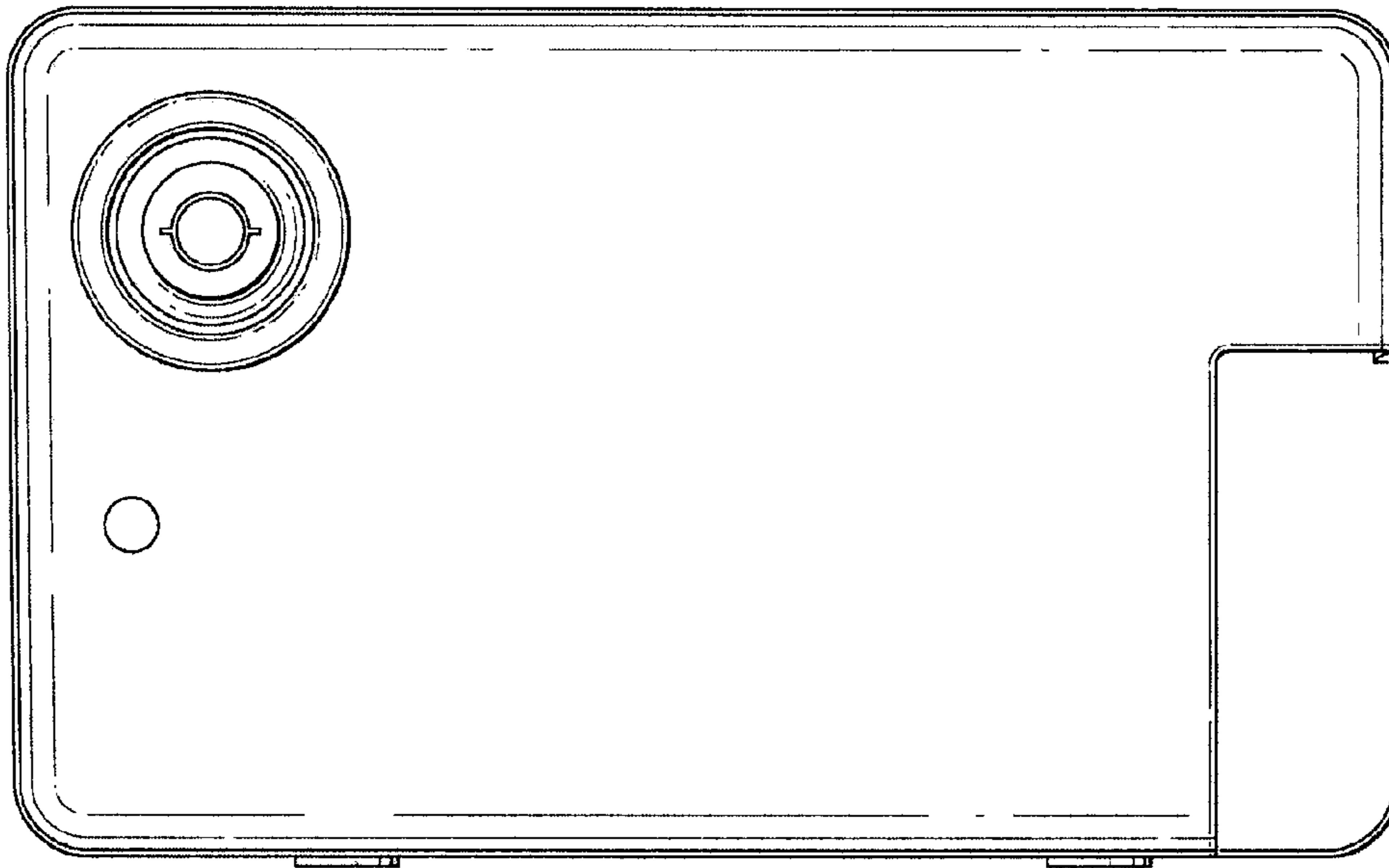

FIG. 3

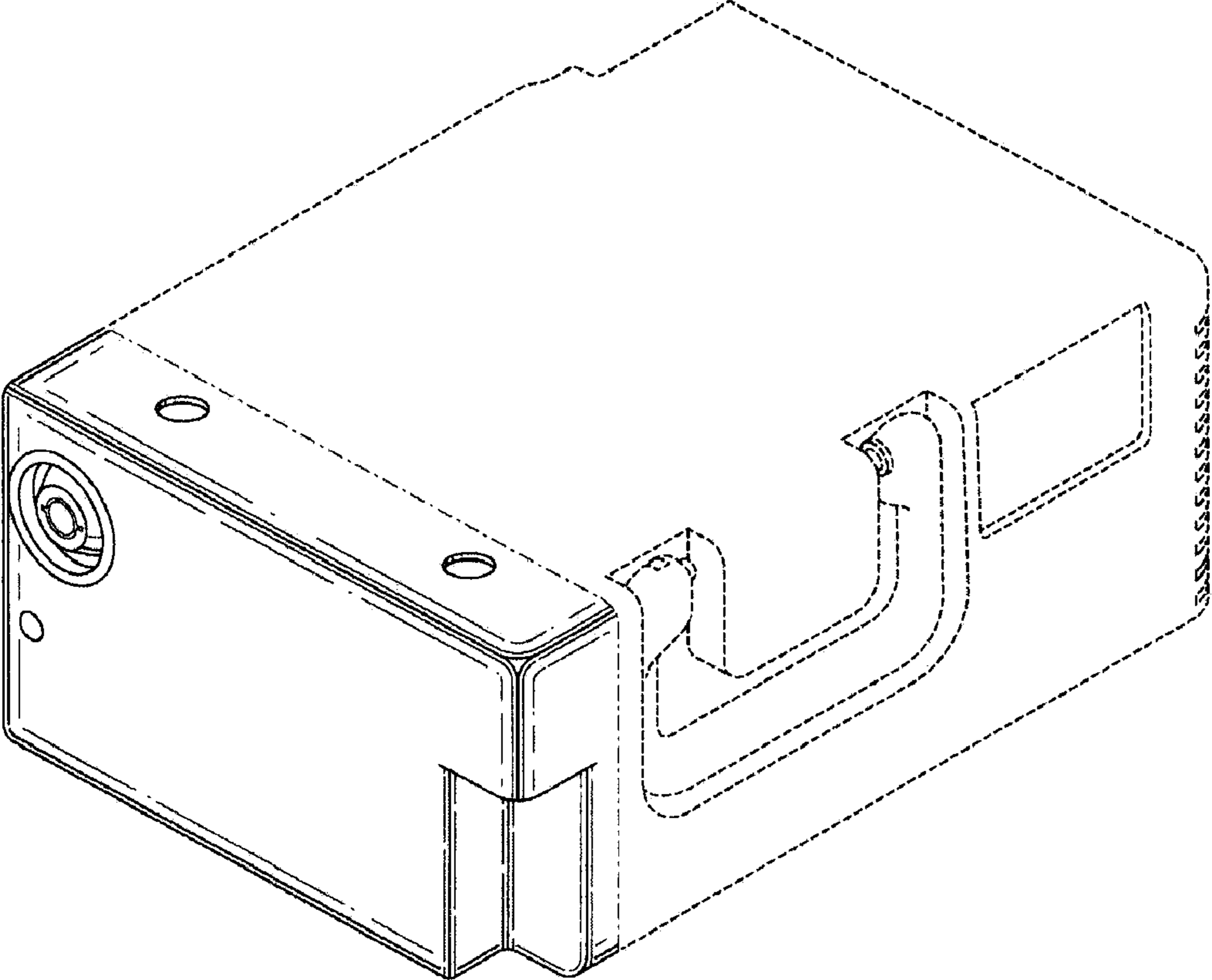

FIG. 4

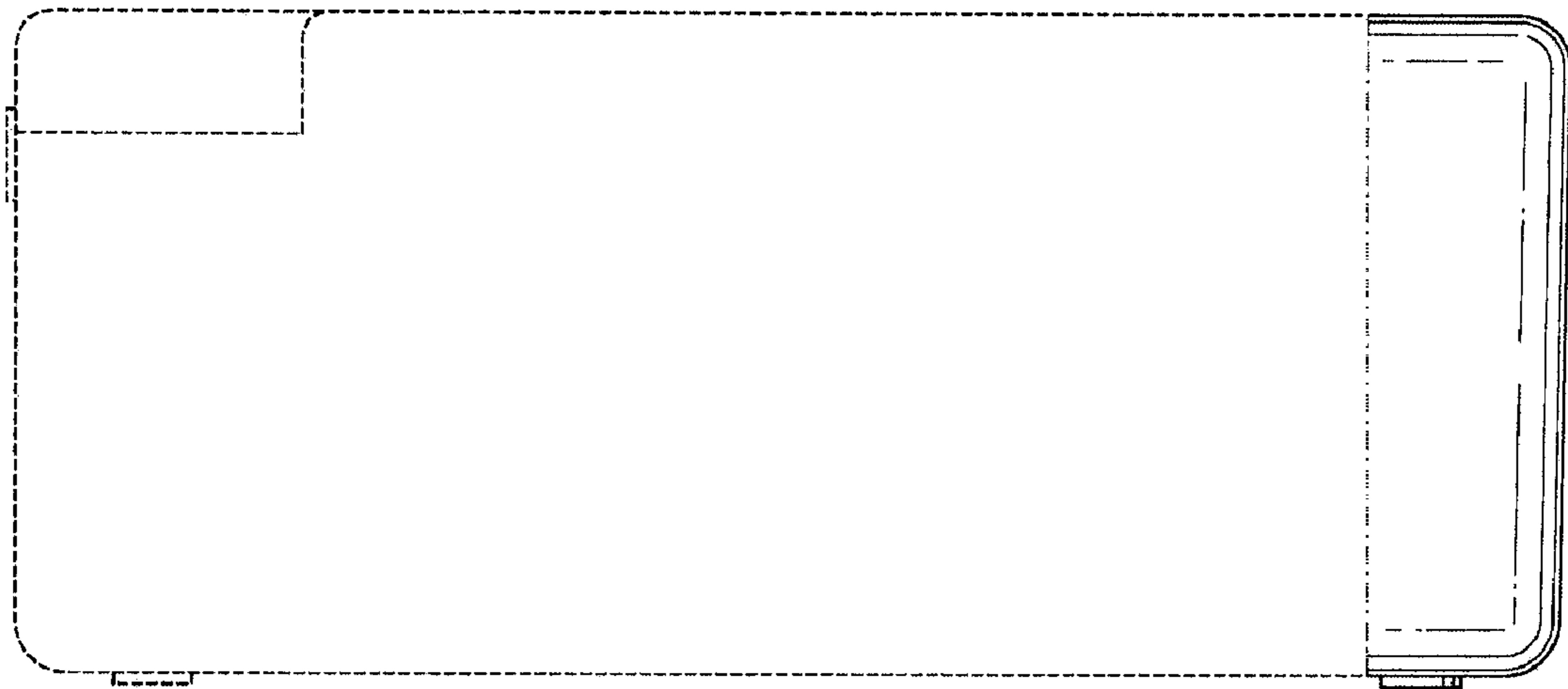

FIG. 5

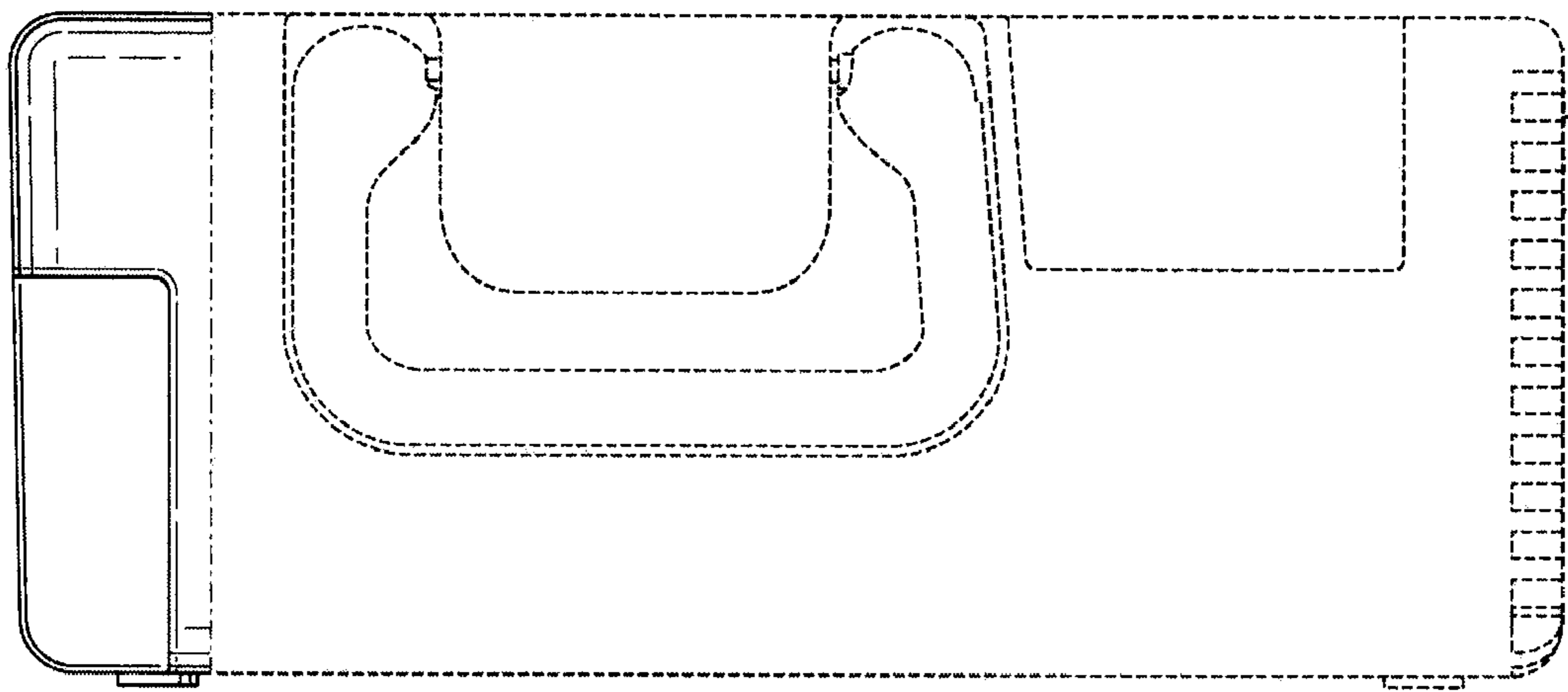

FIG. 6

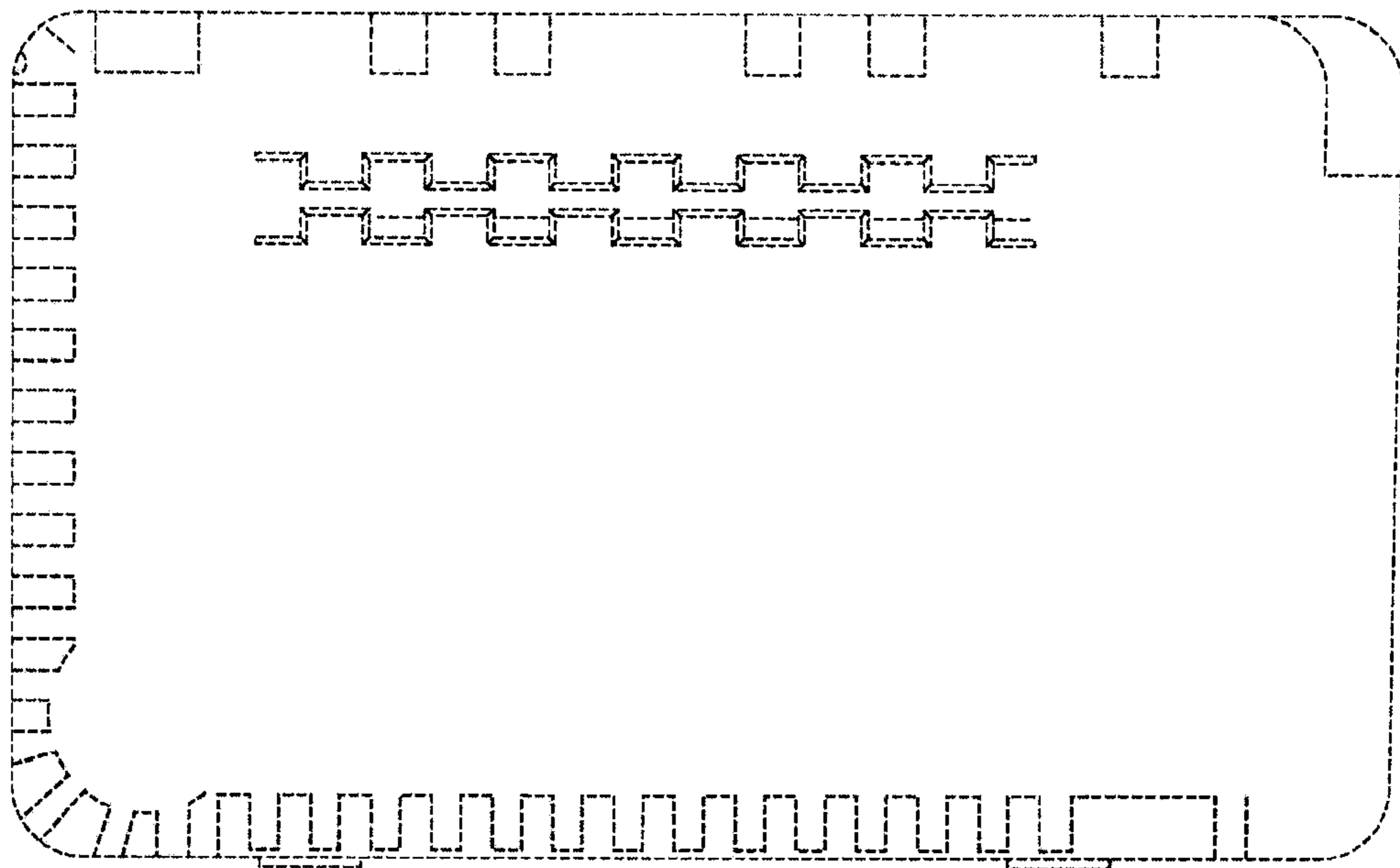

FIG. 7