



US00D592190S

(12) **United States Design Patent**
Birger

(10) **Patent No.:** **US D592,190 S**
(45) **Date of Patent:** **** May 12, 2009**

(54) **HEADSET**

(75) Inventor: **Johan Birger**, København (DK)

(73) Assignee: **GN A/S**, Ballerup (DK)

(**) Term: **14 Years**

(21) Appl. No.: **29/295,897**

(22) Filed: **Oct. 10, 2007**

(30) **Foreign Application Priority Data**

May 3, 2007 (EM) 000717202

(51) **LOC (9) Cl.** **14-01**

(52) **U.S. Cl.** **D14/223**

(58) **Field of Classification Search** D14/205,
D14/206, 223; 181/129, 130, 135; 379/430,
379/433.03, 446; 381/380, 381
See application file for complete search history.

(56) **References Cited**

U.S. PATENT DOCUMENTS

D480,386 S *	10/2003	Browne et al.	D14/223
D502,171 S *	2/2005	Tang et al.	D14/223
D509,210 S *	9/2005	Skulley et al.	D14/205
D520,497 S *	5/2006	Yang	D14/223
D529,021 S *	9/2006	Jensen et al.	D14/223
D538,268 S *	3/2007	Gibson et al.	D14/223
D542,267 S *	5/2007	Cha et al.	D14/206
D555,150 S *	11/2007	Christopher et al.	D14/223
D555,151 S *	11/2007	Eklund et al.	D14/223
D555,153 S *	11/2007	Wilson et al.	D14/223

D561,743 S *	2/2008	Huang et al.	D14/223
D562,808 S *	2/2008	Gwee	D14/223
D565,033 S *	3/2008	Goransson	D14/223
D566,693 S *	4/2008	Jensen et al.	D14/223
D566,694 S *	4/2008	Kim et al.	D14/223
D566,695 S *	4/2008	Rath	D14/223
D569,842 S *	5/2008	Yang	D14/205
D569,849 S *	5/2008	Goransson	D14/223
D573,139 S *	7/2008	Birger	D14/223
D573,582 S *	7/2008	Ma	D14/205
D574,366 S *	8/2008	Sade et al.	D14/223
D574,367 S *	8/2008	Jaakkola et al.	D14/223
D575,277 S *	8/2008	Gaarde et al.	D14/223
D576,609 S *	9/2008	Bradford et al.	D14/223

* cited by examiner

Primary Examiner—Paula Greene

(74) *Attorney, Agent, or Firm*—Altera Law Group, LLC

(57) **CLAIM**

The ornamental design for headset, as shown and described.

DESCRIPTION

FIG. 1 is a perspective view of a headset showing my new design;

FIG. 2 is a front view thereof

FIG. 3 is a side view thereof

FIG. 4 is a top view thereof

FIG. 5 is a bottom view thereof

FIG. 6 is a rear view thereof; and,

FIG. 7 is an opposite side view thereof.

1 Claim, 3 Drawing Sheets

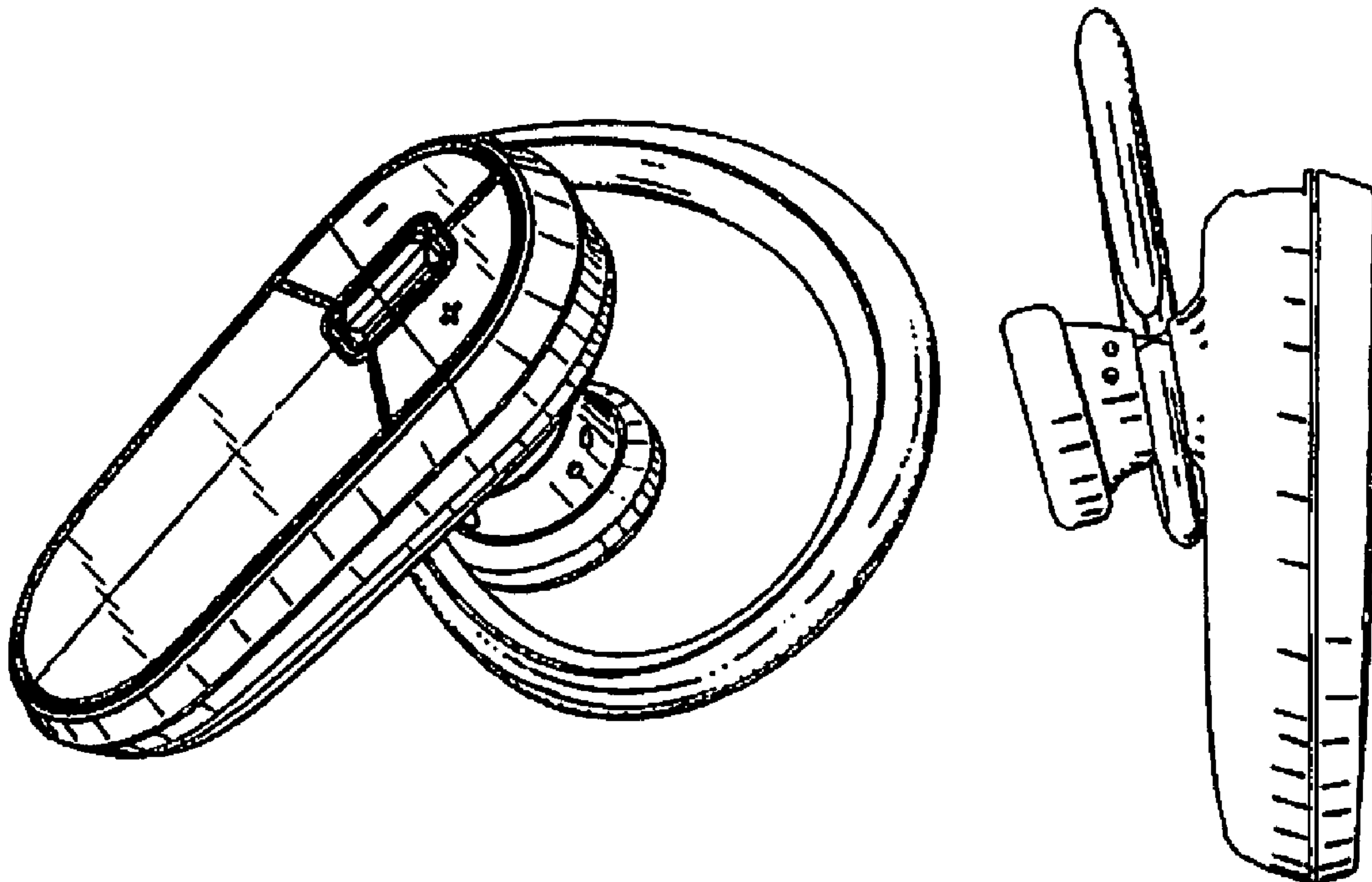

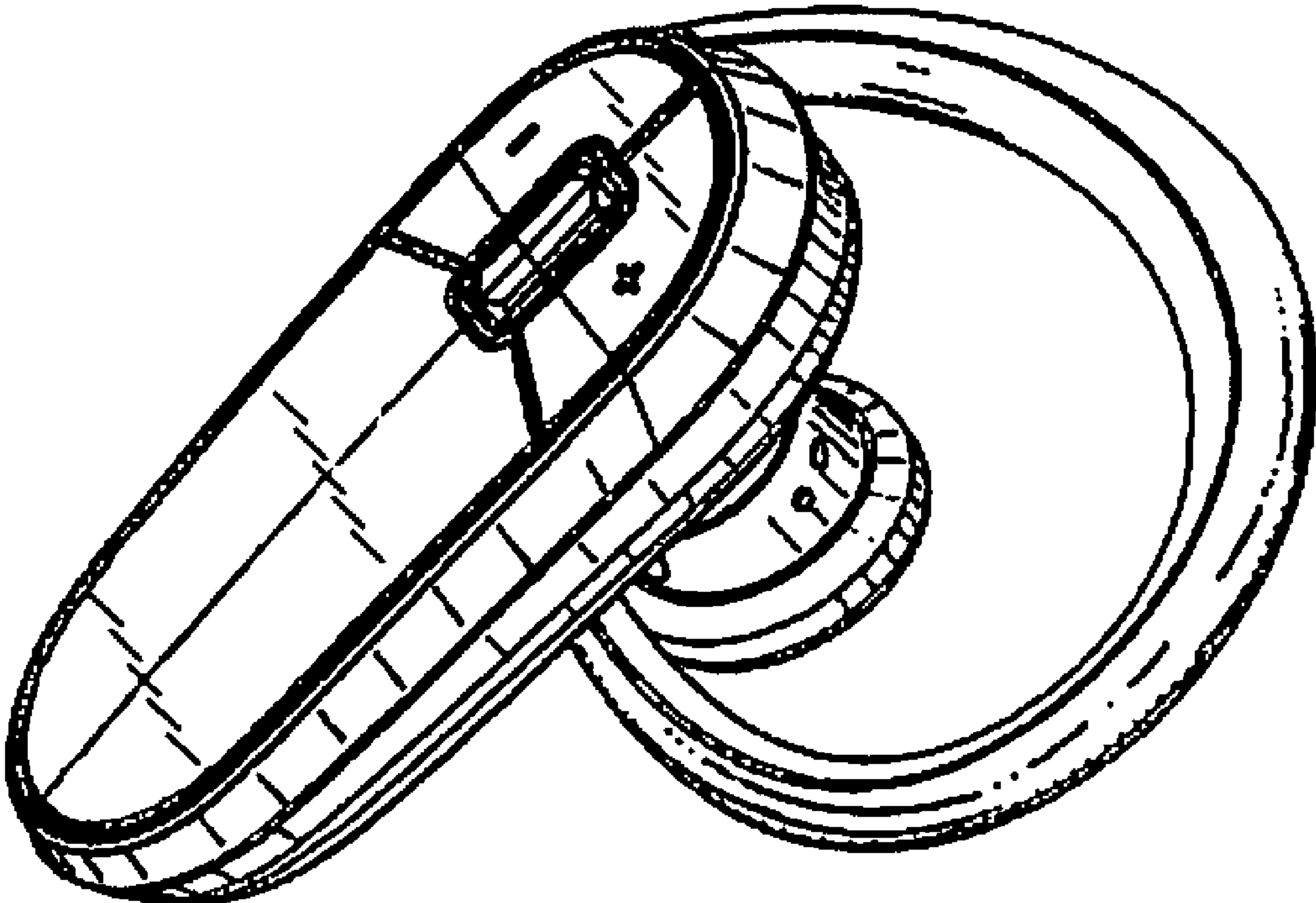

FIG. 1

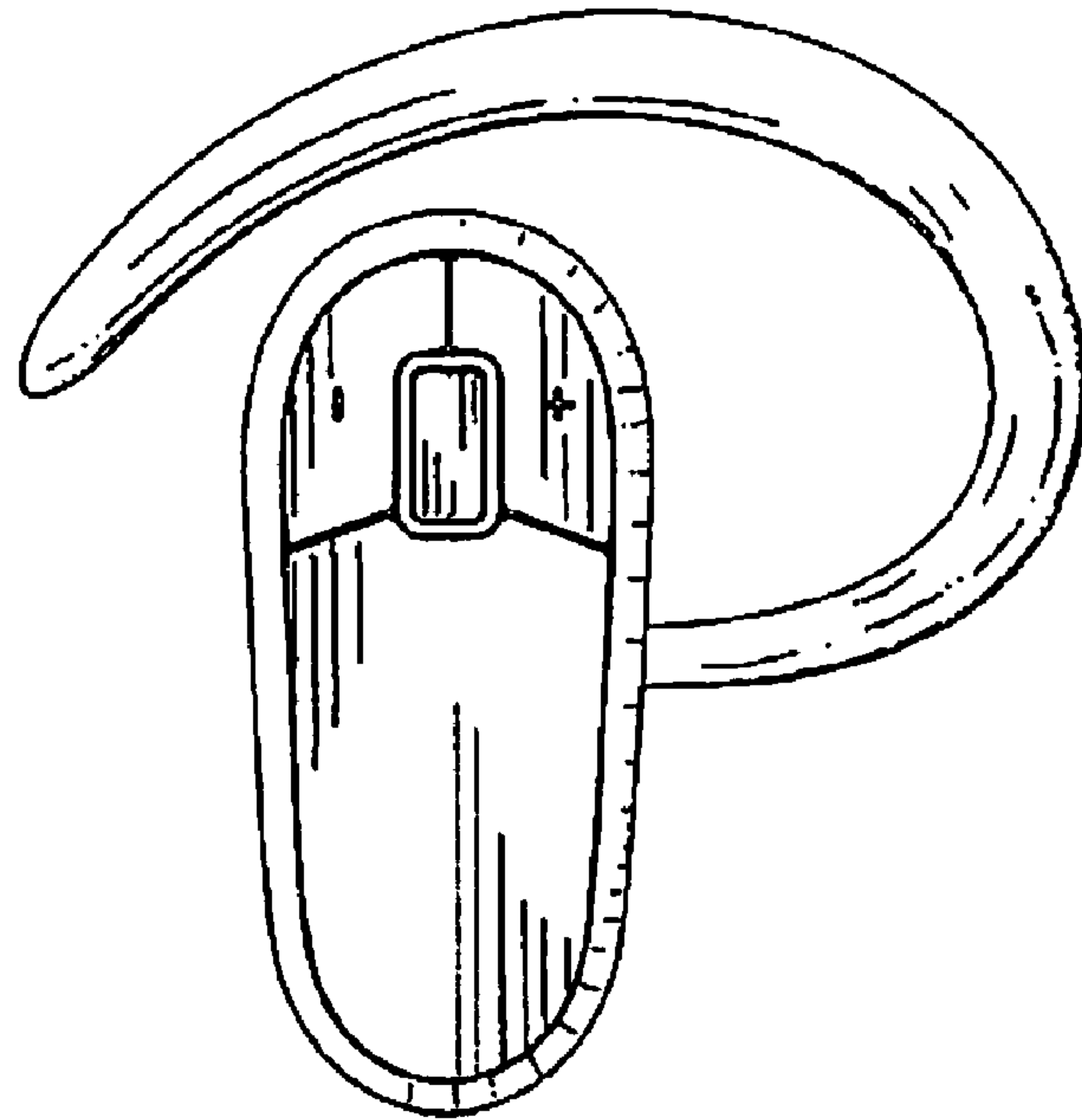

FIG. 2

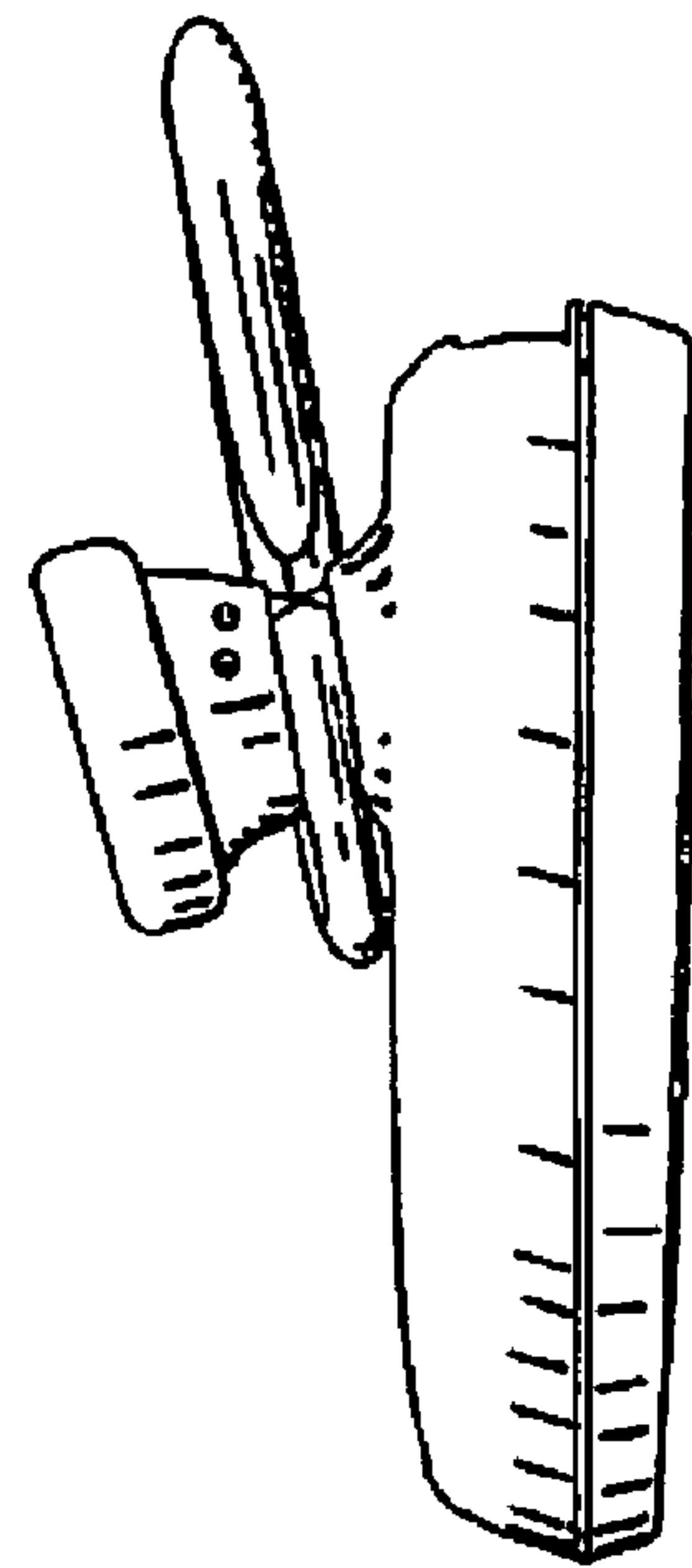

FIG. 3

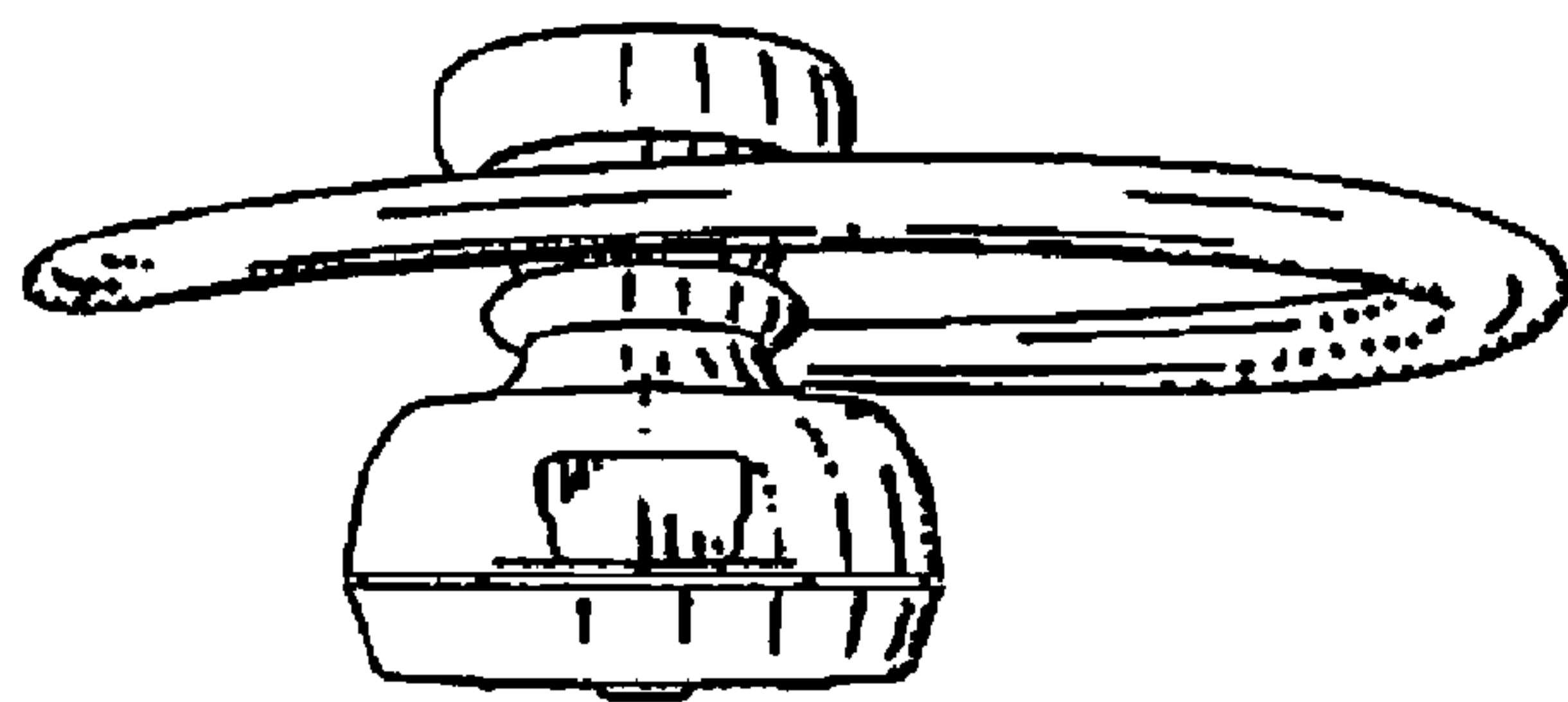

FIG. 4

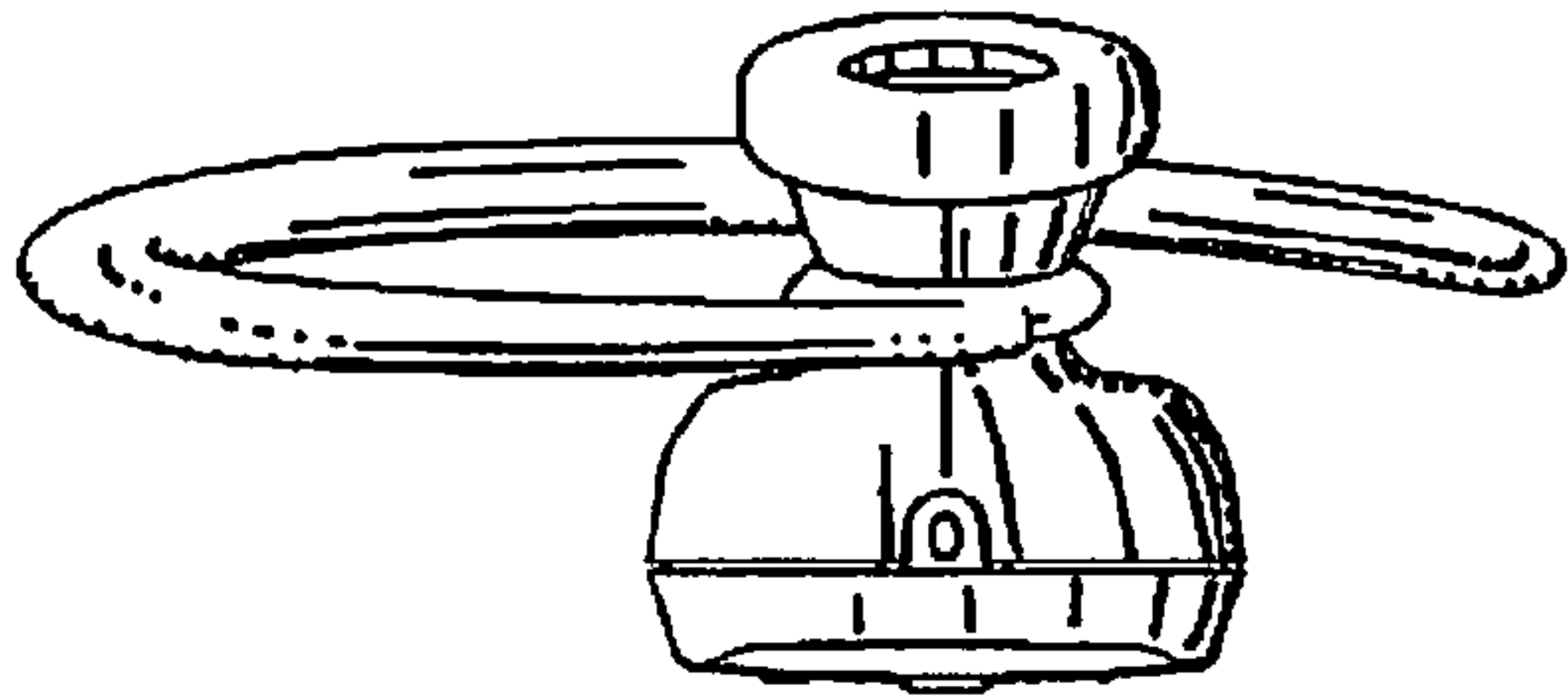

FIG. 5

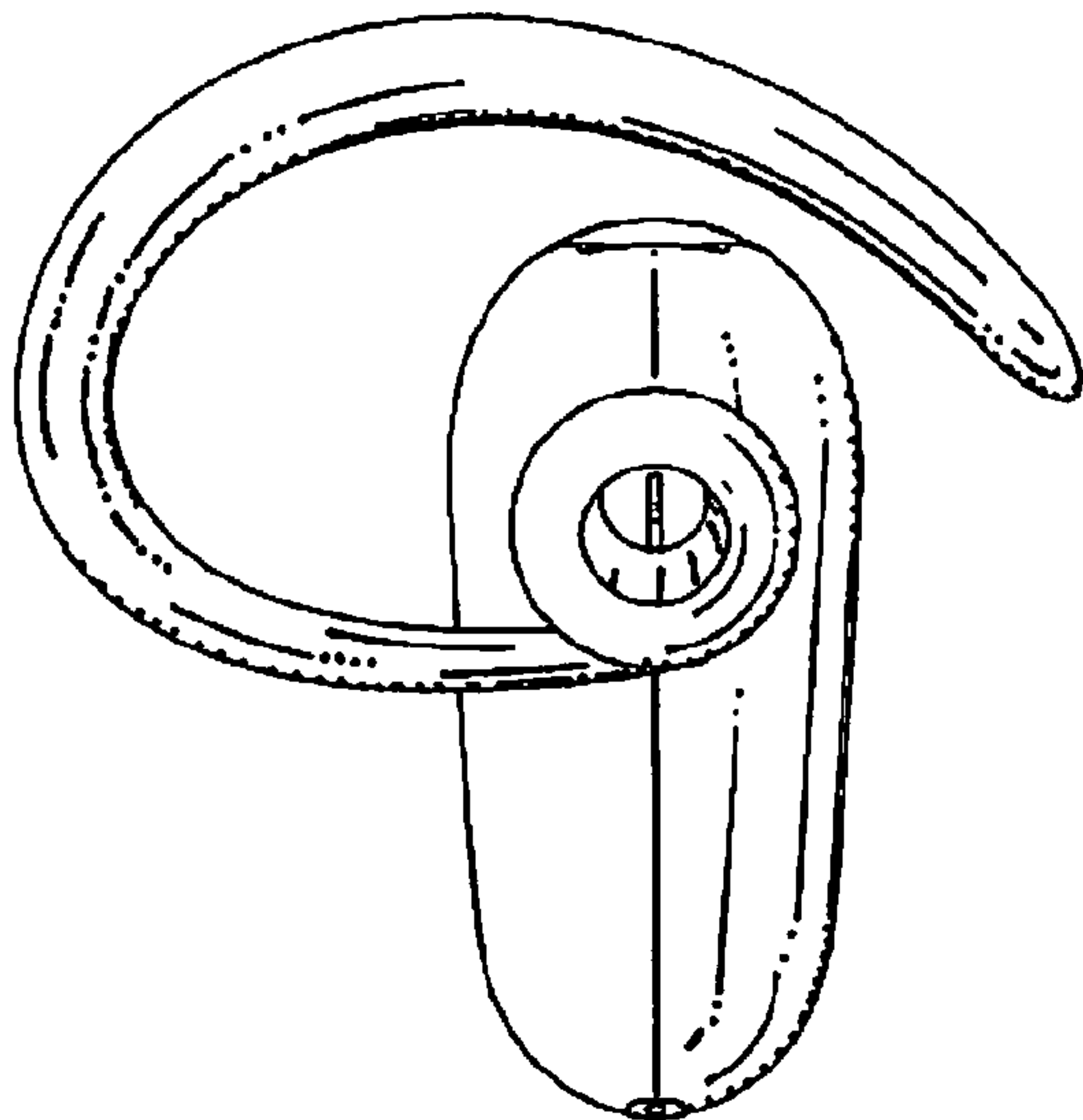

FIG. 6

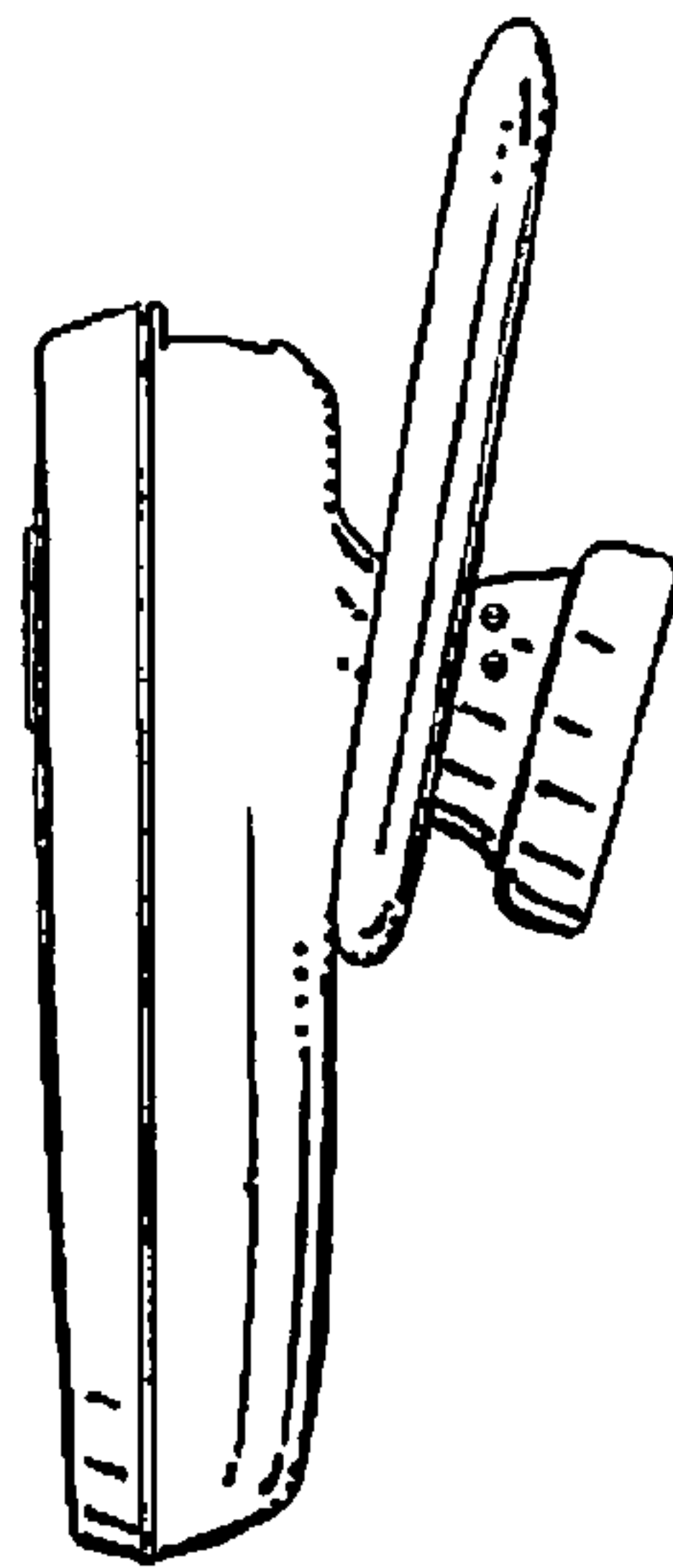

FIG. 7