



US00D592111S

(12) **United States Design Patent**  
**Janik et al.**

(10) **Patent No.:** **US D592,111 S**  
(45) **Date of Patent:** **\*\* May 12, 2009**

(54) **RADIATOR GRILLE FOR VEHICLE**

(75) Inventors: **Brian Janik**, South Lyon, MI (US);  
**Hitoshi Ohashi**, West Bloomfield, MI (US)

(73) Assignee: **Nissan Motor Co., Ltd.**, Yokohama-shi (JP)

(\*\*) Term: **14 Years**

(21) Appl. No.: **29/321,697**

(22) Filed: **Jul. 22, 2008**

(30) **Foreign Application Priority Data**

Jan. 24, 2008 (JP) ..... 2008-001352

(51) **LOC (9) Cl.** ..... **12-16**

(52) **U.S. Cl.** ..... **D12/163**

(58) **Field of Classification Search** ..... D12/163,  
D12/171, 196, 216, 90-92, 86; 180/68.1,  
180/68.6; 296/193.11

See application file for complete search history.

(56) **References Cited**

**U.S. PATENT DOCUMENTS**

D495,979 S \* 9/2004 Metros et al. .... D12/163  
D500,461 S \* 1/2005 Noguchi et al. .... D12/98  
D523,381 S \* 6/2006 Taguchi et al. .... D12/163

D533,484 S \* 12/2006 Behmer et al. .... D12/163  
D535,223 S \* 1/2007 Gaffka et al. .... D12/163  
D537,019 S \* 2/2007 Pfeiffer ..... D12/163  
D565,478 S \* 4/2008 Abe ..... D12/163  
D577,635 S \* 9/2008 Moore ..... D12/163

\* cited by examiner

*Primary Examiner*—Melody N Brown

(74) *Attorney, Agent, or Firm*—Foley & Lardner LLP

(57) **CLAIM**

The ornamental design for a radiator grille for vehicle, as shown and described.

**DESCRIPTION**

FIG. 1 is a perspective view of a radiator grille for vehicle;

FIG. 2 is a front view thereof;

FIG. 3 is a rear view thereof;

FIG. 4 is a top plan view thereof;

FIG. 5 is a bottom plan view thereof;

FIG. 6 is a left side view thereof;

FIG. 7 is a right side view thereof;

FIG. 8 is an enlarged sectional view thereof taken along line 8—8; and,

FIG. 9 is an enlarged sectional view thereof taken along line 9—9.

**1 Claim, 3 Drawing Sheets**

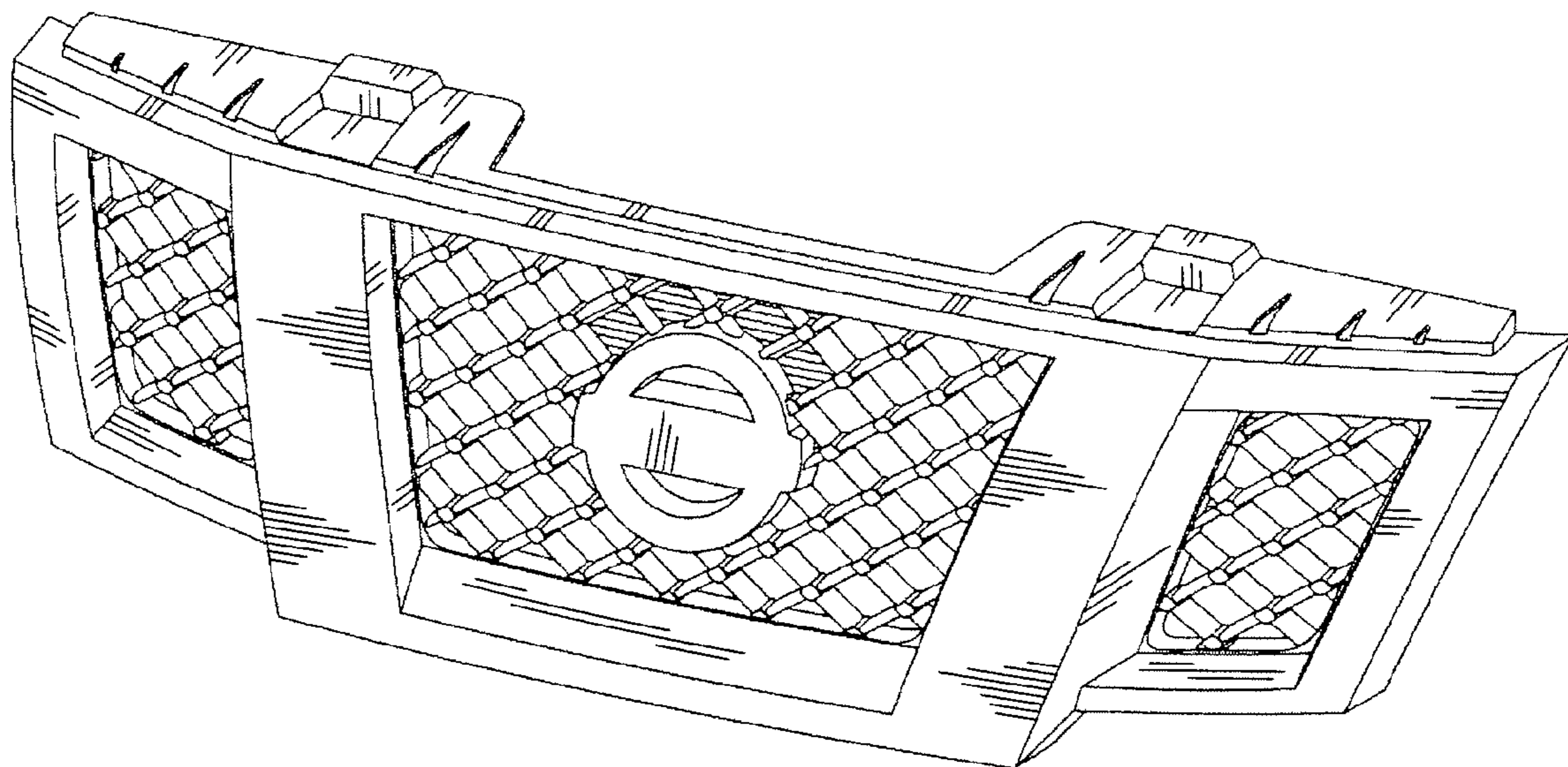

Fig.1

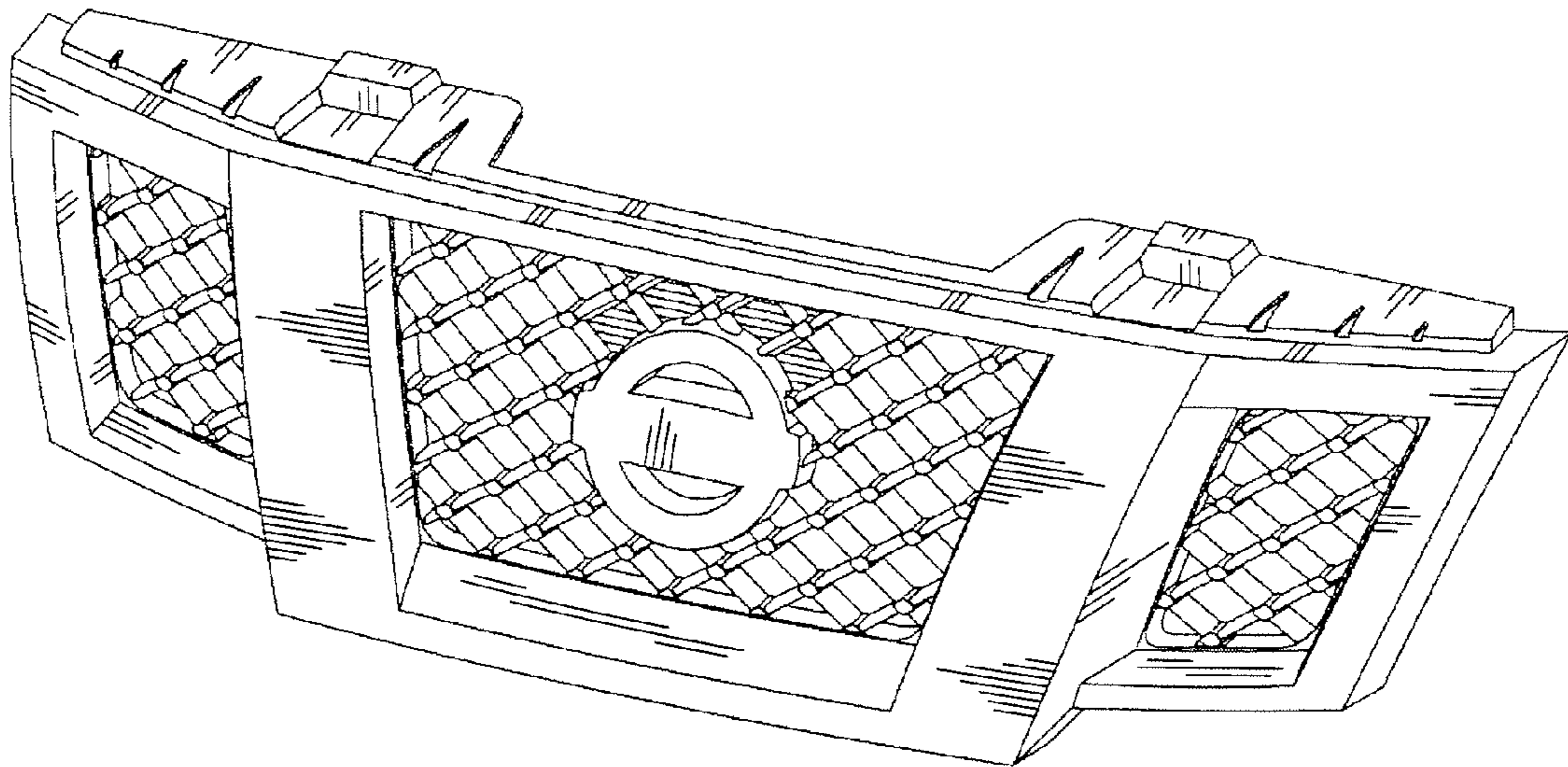

Fig.2

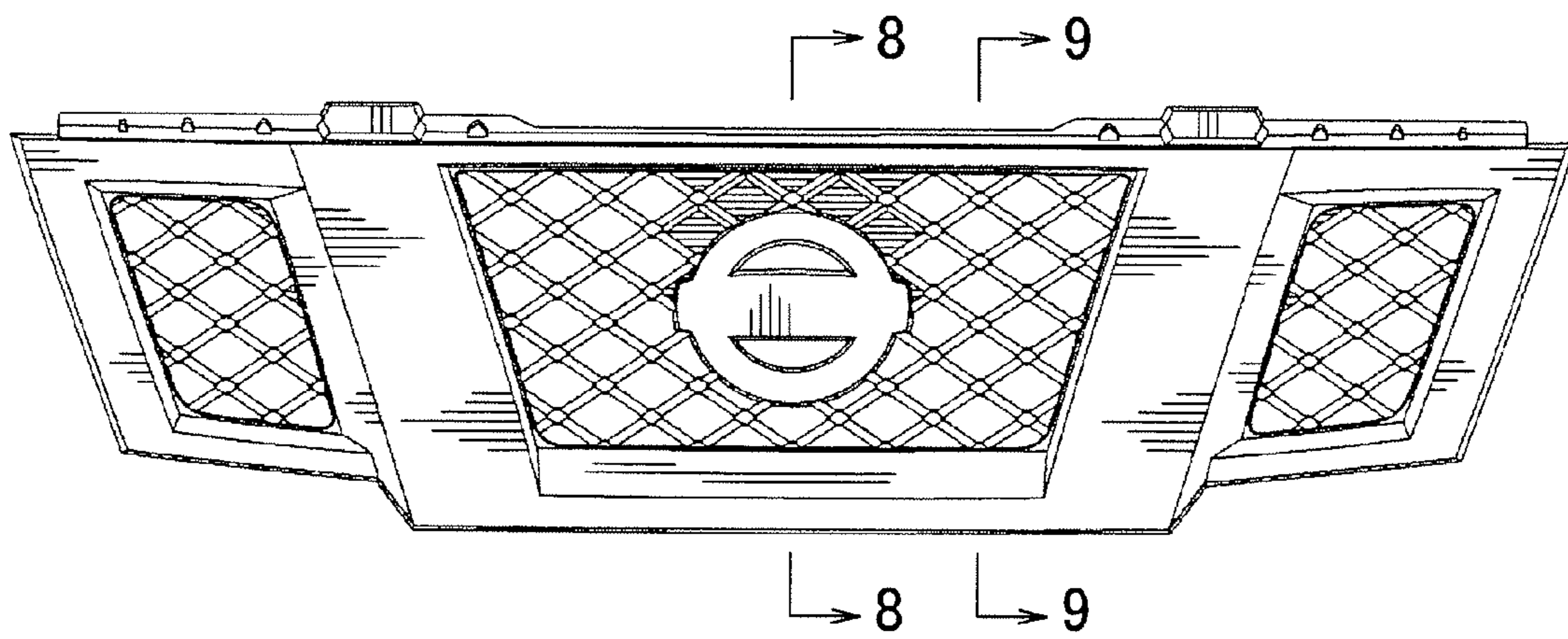

Fig.3

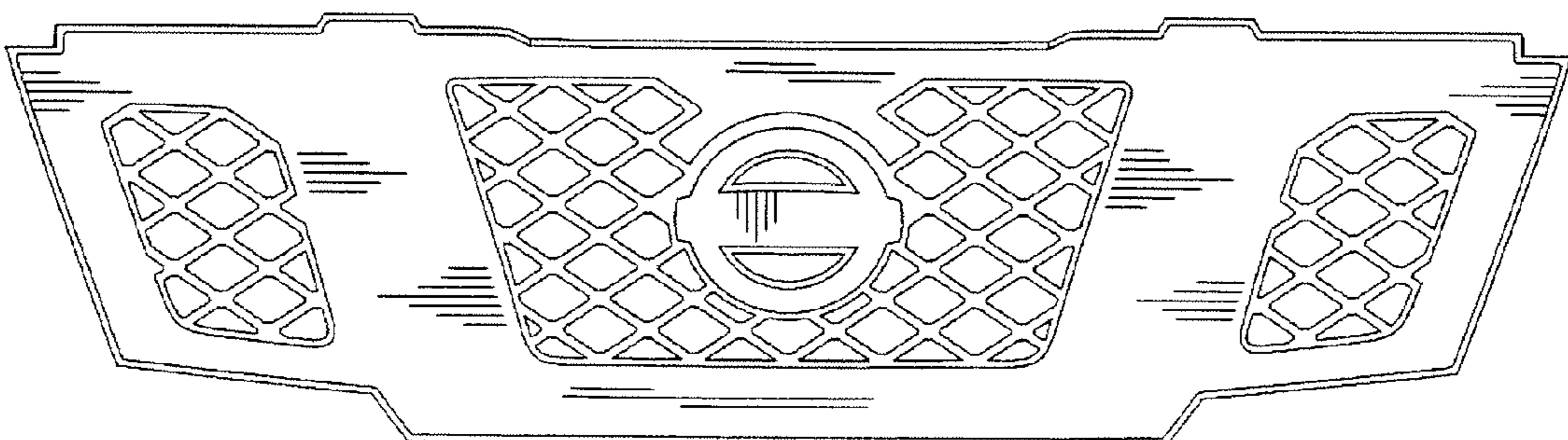

Fig.4

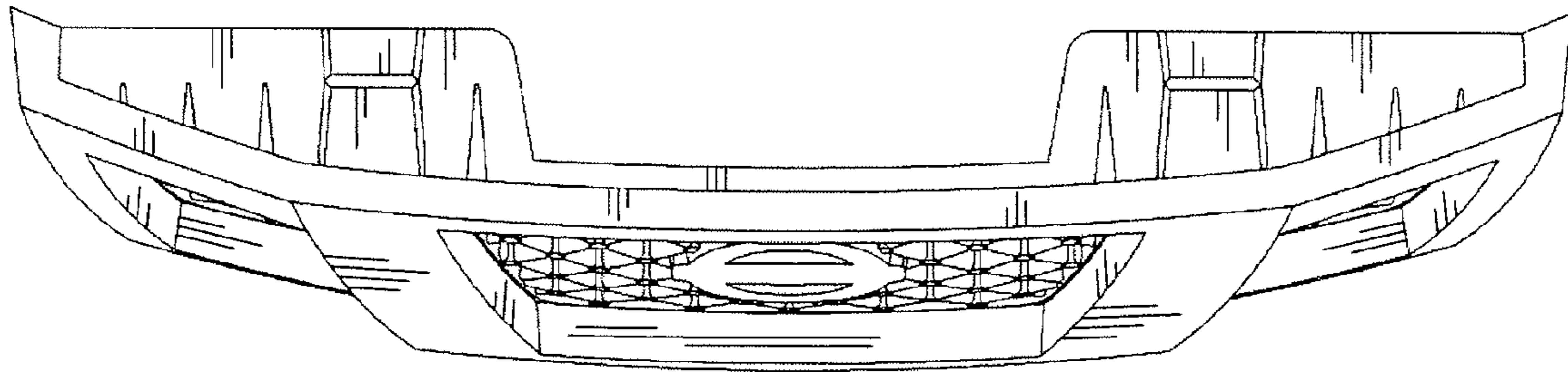

Fig.5

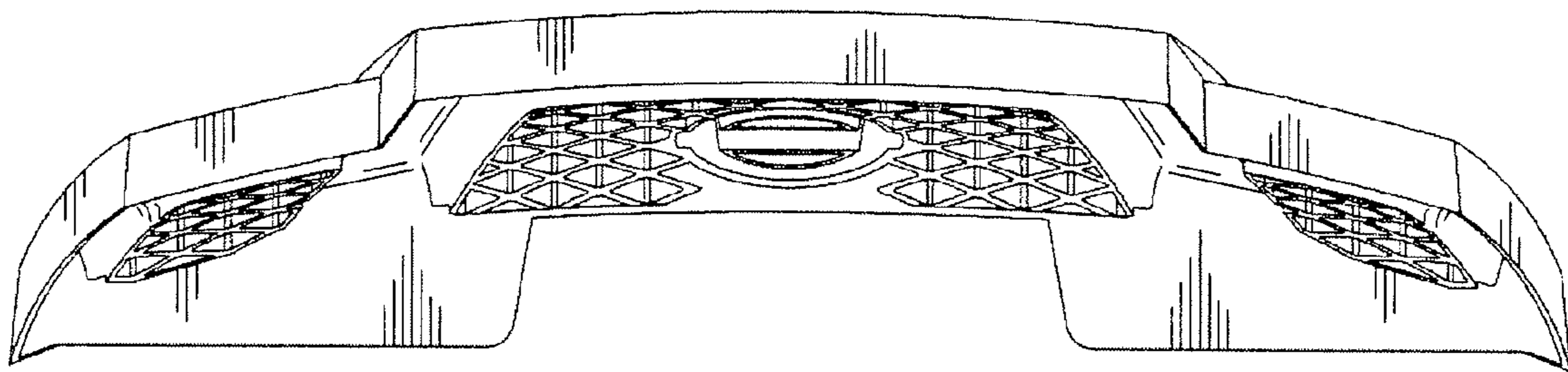

Fig.6

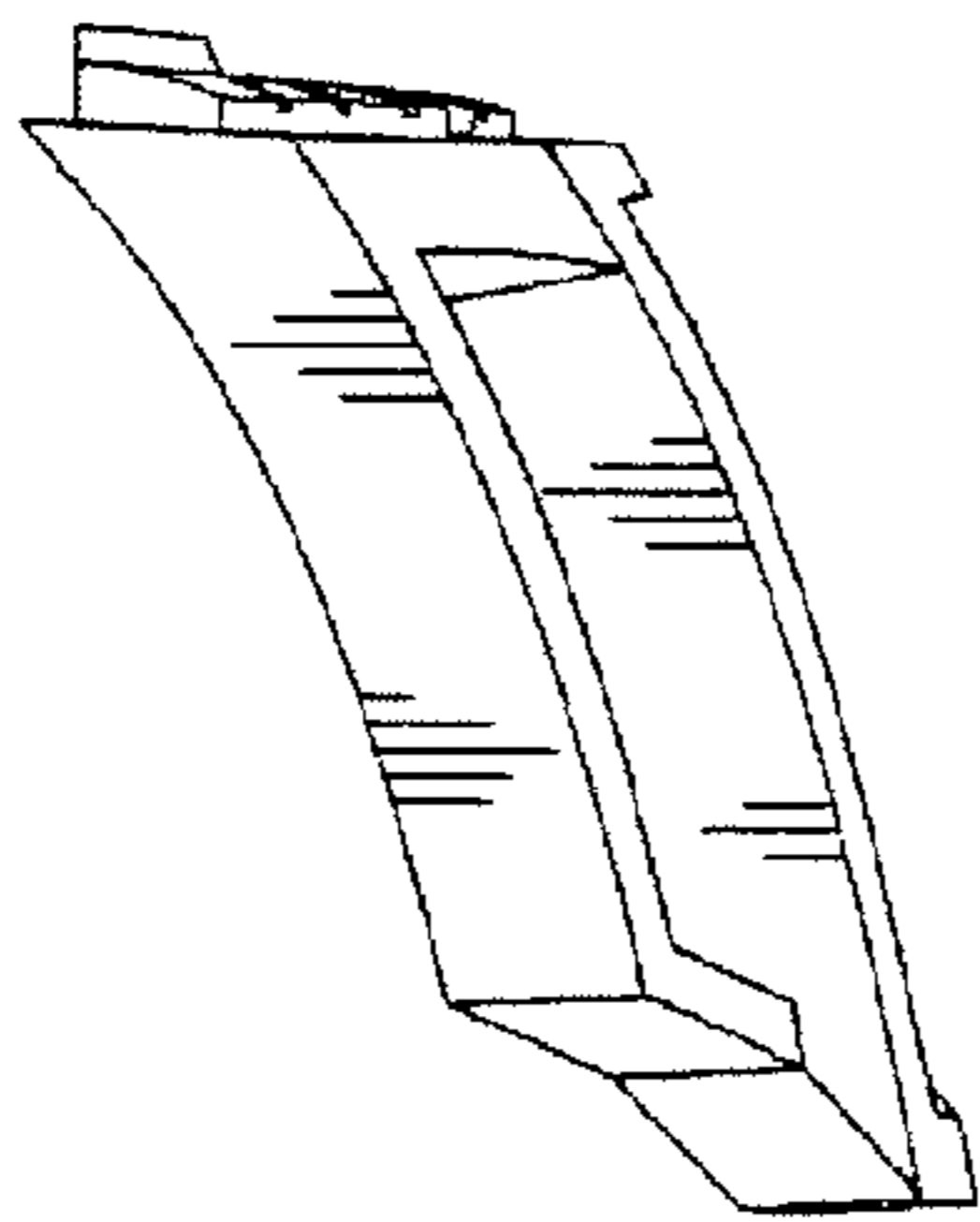

Fig.7

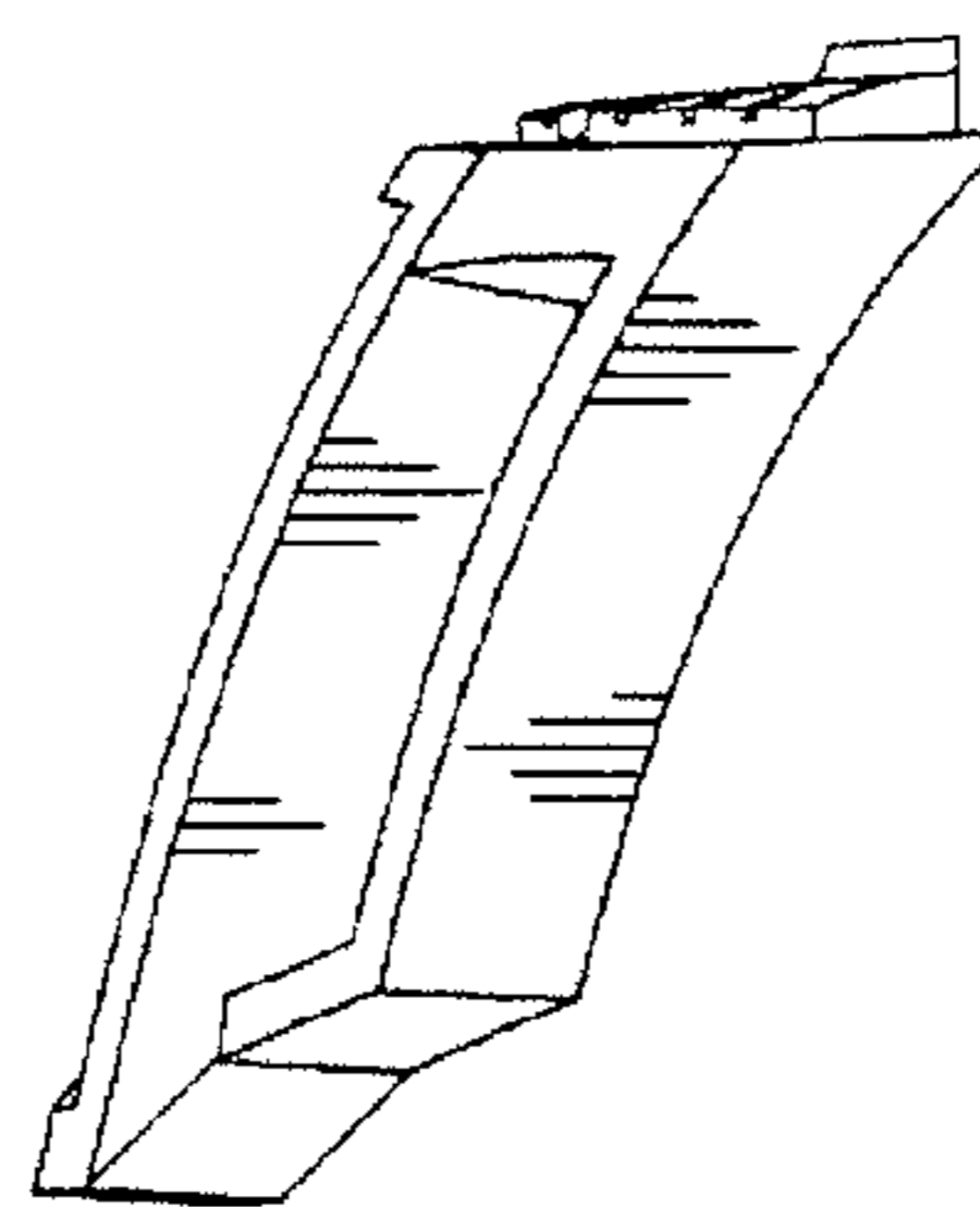

Fig.8

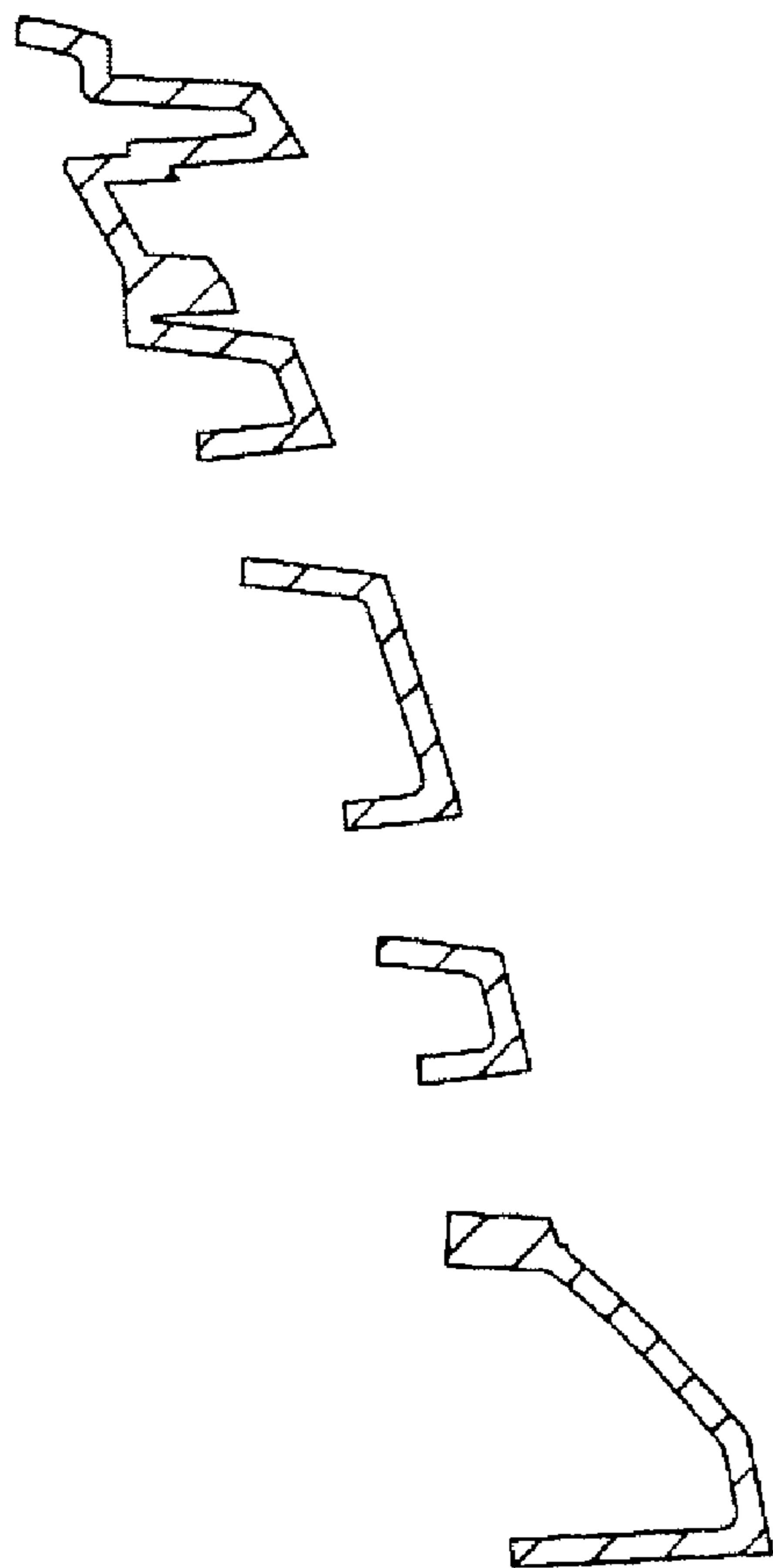

Fig.9

