



US00D592049S

(12) **United States Design Patent**  
**Doliwa et al.**

(10) **Patent No.:** **US D592,049 S**

(45) **Date of Patent:** **\*\* \*May 12, 2009**

(54) **COMBINED BASE AND COVER**

(75) Inventors: **Wojciech Marek Doliwa**, Sayreville, NJ (US); **Justin Andres**, East Brunswick, NJ (US)

(73) Assignee: **Sabert Corporation**, Sayreville, NJ (US)

(\*) Notice: This patent is subject to a terminal disclaimer.

(\*\*) Term: **14 Years**

(21) Appl. No.: **29/300,765**

(22) Filed: **May 8, 2008**

(51) **LOC (9) Cl.** ..... **09-03**

(52) **U.S. Cl.** ..... **D9/425; D9/432; D7/629**

(58) **Field of Classification Search** ..... D0/414-415, D0/418, 423-429, 431-432, 435, 452-453, D0/515, 761; D7/354, 504, 500, 538, 550.1, D7/543, 545, 553.6, 554.2, 557, 565, 584-585, D7/602, 629, 672; D3/201, 203.1-203.3, D3/304, 307-314; 220/4.21-4.24, 23.8, 220/23.87, 266, 276, 377, 532-533, 655, 220/781-784, 790-791, 793, 835; 206/45.19, 206/45.32, 386, 425, 503, 508, 509, 511, 206/518-521, 541, 555, 558, 560, 564, 625, 206/643; 229/120, 125, 406; 426/106, 119, 426/129, 234; 219/734

See application file for complete search history.

(56) **References Cited**

**U.S. PATENT DOCUMENTS**

3,307,603 A \* 3/1967 Swett ..... 220/783  
3,483,964 A \* 12/1969 Muehling et al. .... 426/123  
D219,673 S \* 1/1971 Daenen ..... D7/629

(Continued)

*Primary Examiner*—Robert M Spear

*Assistant Examiner*—Susan E Krakower

(74) *Attorney, Agent, or Firm*—Ezra Sutton

(57) **CLAIM**

The ornamental design for a combined base and cover, as shown and described.

**DESCRIPTION**

FIG. 1 is a front perspective view of a combined base and cover showing a first embodiment of our new design;

FIG. 2 is a front view thereof, shown in an enlarged scale;

FIG. 3 is a rear view thereof;

FIG. 4 is a left side view thereof;

FIG. 5 is a right side view thereof;

FIG. 6 is a top plan view thereof;

FIG. 7 is a bottom plan view thereof;

FIG. 8 is a front perspective view of a combined base and cover showing a second embodiment of our new design, shown in a reduced scale;

FIG. 9 is a front view thereof, shown in an enlarged scale;

FIG. 10 is a rear view thereof;

FIG. 11 is a left side view thereof;

FIG. 12 is a right side view thereof;

FIG. 13 is a top plan view thereof, shown in a reduced scale;

FIG. 14 is a bottom plan view thereof;

FIG. 15 is a front perspective view of a combined base and cover showing a third embodiment of our new design, shown in a reduced scale;

FIG. 16 is a front view thereof, shown in an enlarged scale;

FIG. 17 is a rear view being thereof;

FIG. 18 is a left side view thereof;

FIG. 19 is a right side view thereof;

FIG. 20 is a top plan view thereof; and,

FIG. 21 is a bottom plan view thereof.

The broken lines in FIGS. 7, 14 and 21 illustrate the boundary of the claim and form no part of the claimed design.

**1 Claim, 21 Drawing Sheets**

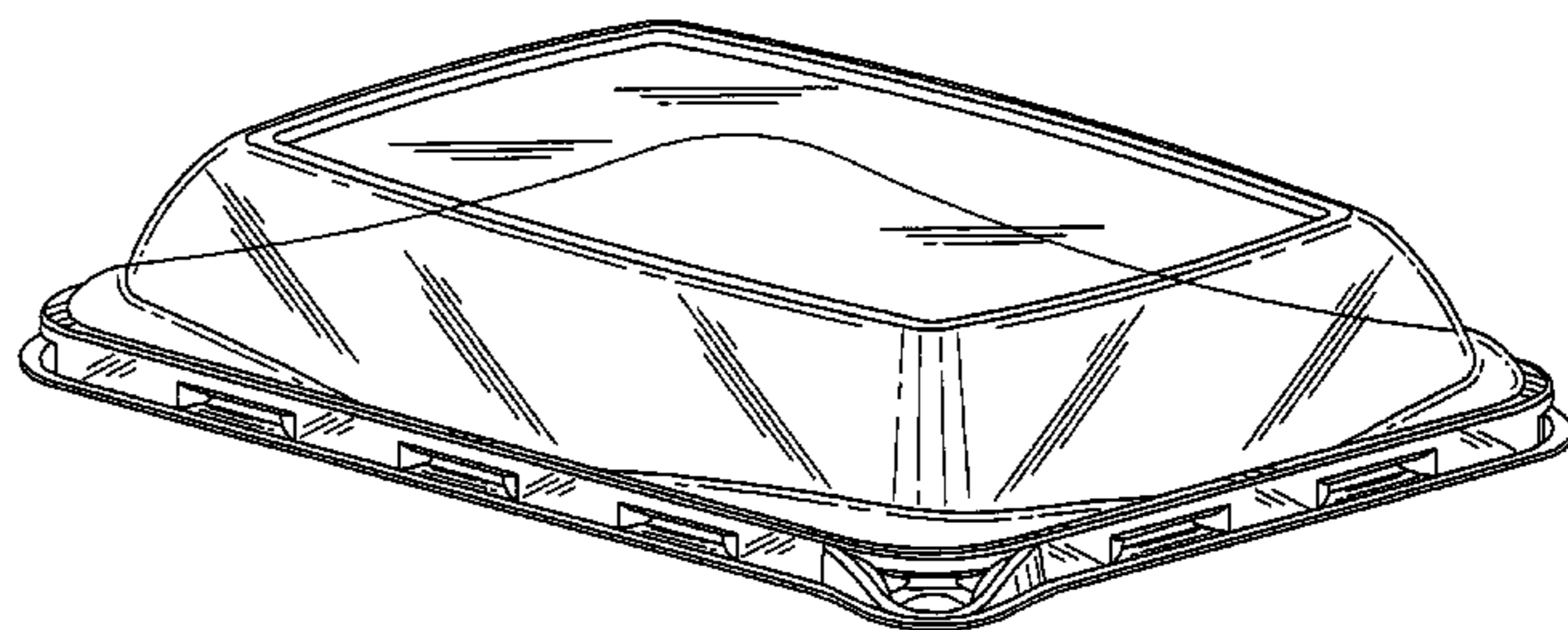
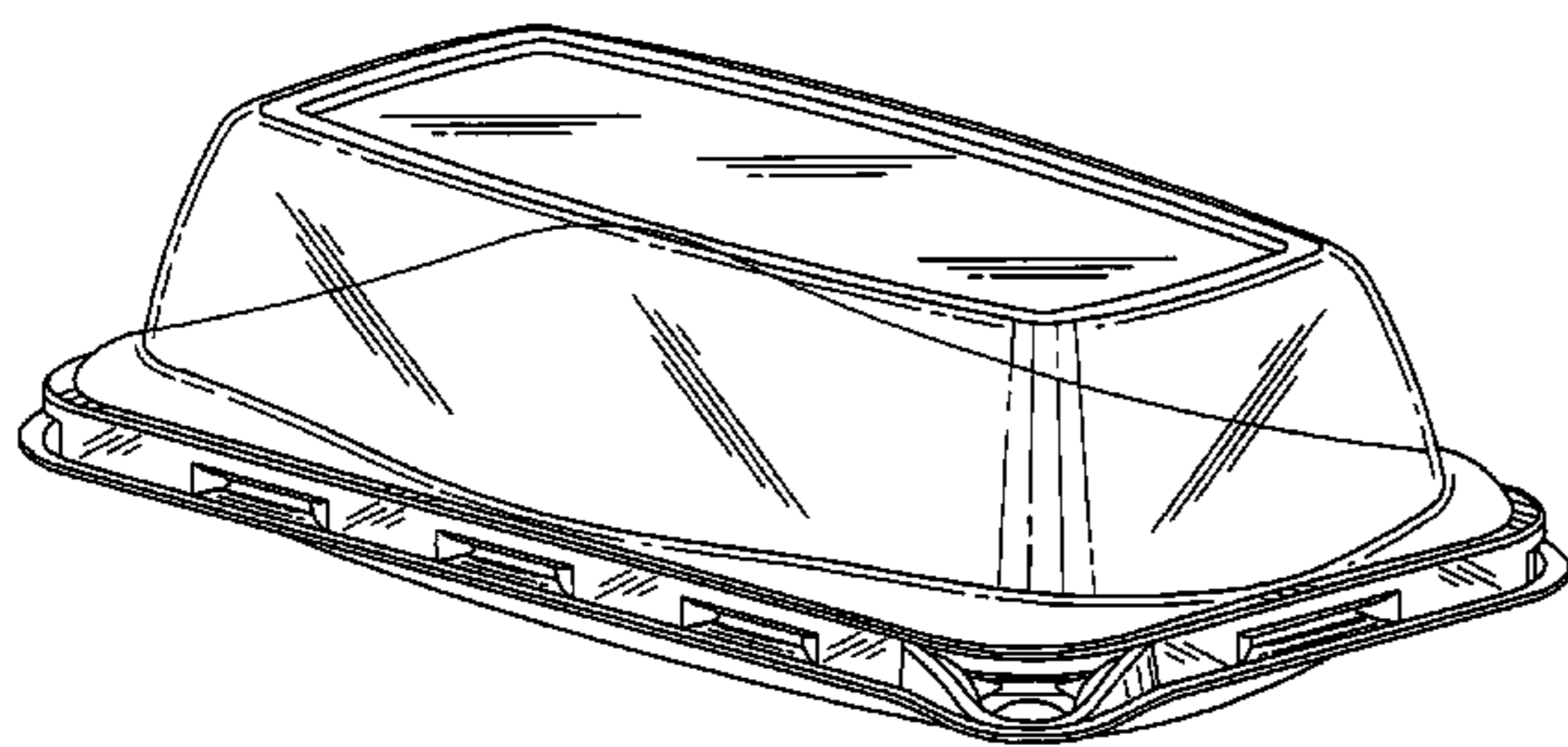

# US D592,049 S

Page 2

---

## U.S. PATENT DOCUMENTS

3,863,833	A *	2/1975	Swett et al. ....	220/4.21	5,860,530	A *	1/1999	Simmons et al. ....	206/557
D235,406	S *	6/1975	Daenen .....	D7/629	D479,128	S *	9/2003	Jowett .....	D9/425
D273,565	S *	4/1984	Driskell et al. ....	D9/415	D501,403	S *	2/2005	Wilcock et al. ....	D9/425
D274,300	S *	6/1984	Pozzi .....	D7/542	D513,383	S *	1/2006	Glander et al. ....	D9/435
D298,791	S *	12/1988	Holz Kopf .....	D7/542	D527,956	S *	9/2006	Doliwa .....	D7/629
D320,743	S *	10/1991	Alexander et al. ....	D9/425	D551,975	S *	10/2007	Gomoll et al. ....	D9/452
D331,011	S *	11/1992	Karita et al. ....	D9/415	D557,601	S *	12/2007	Minidis .....	D9/425
5,377,860	A *	1/1995	Littlejohn et al. ....	220/790					

\* cited by examiner

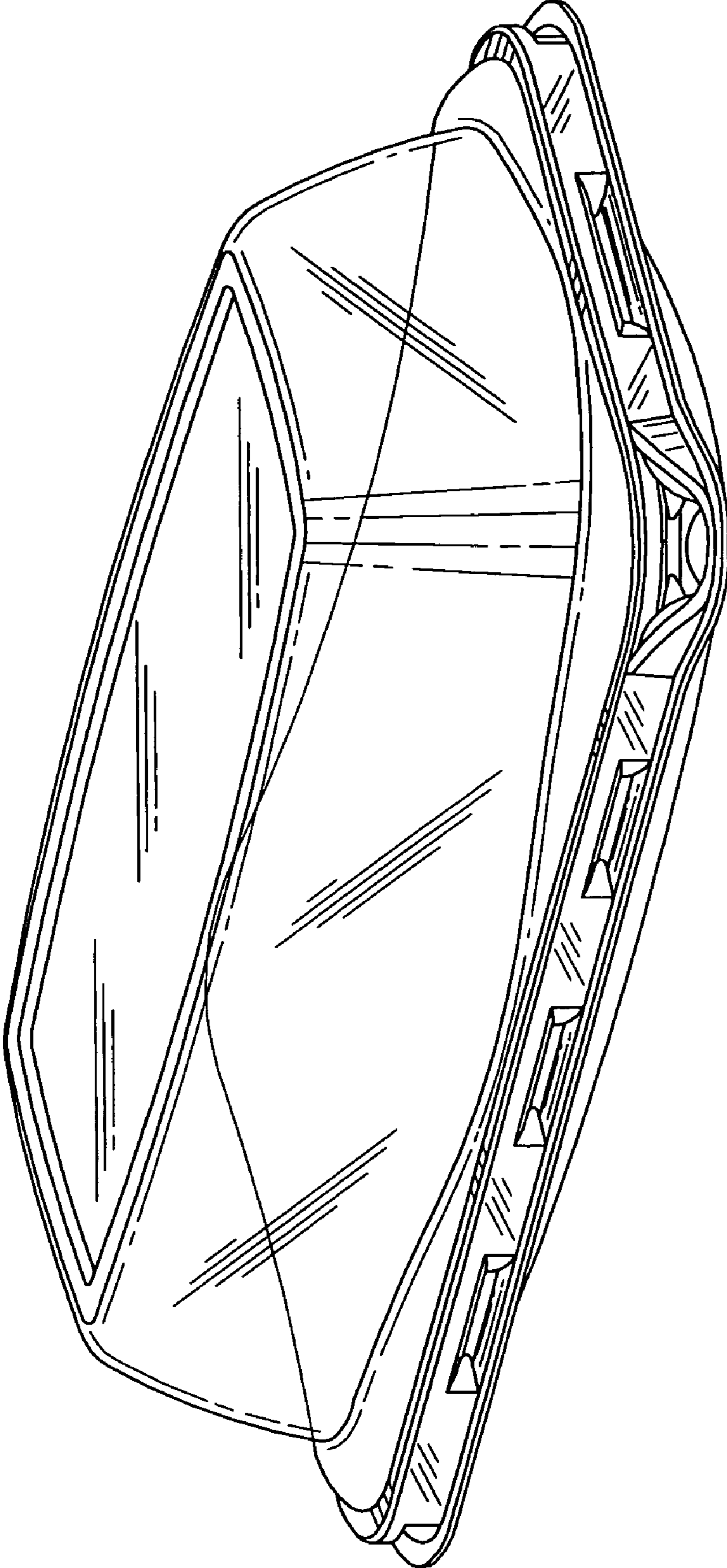

FIG. 1

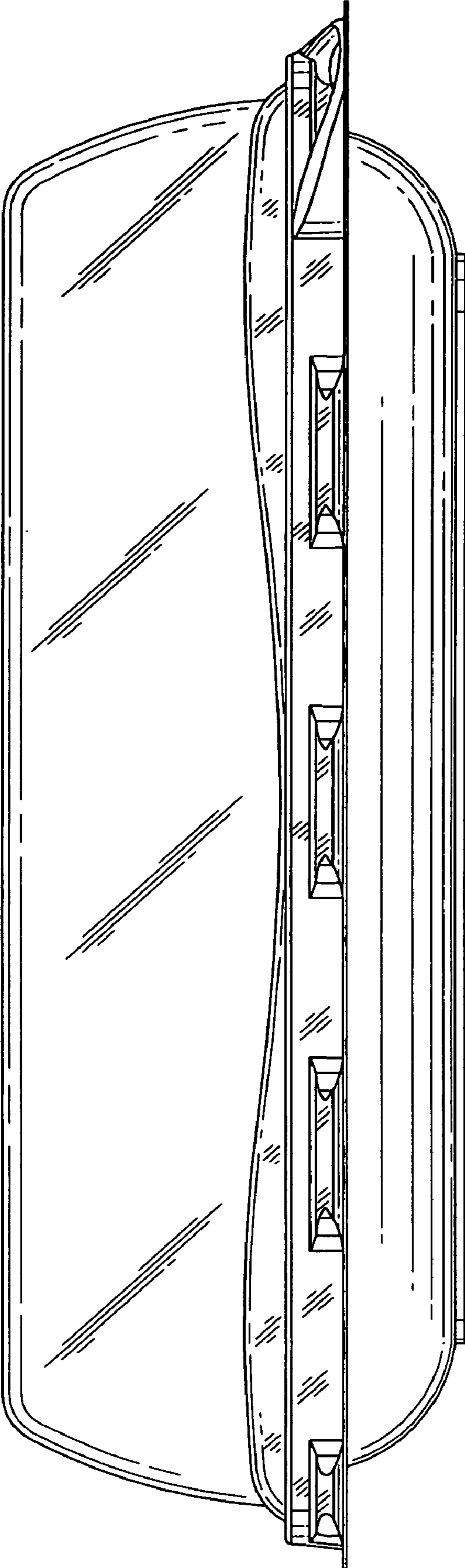

FIG. 2

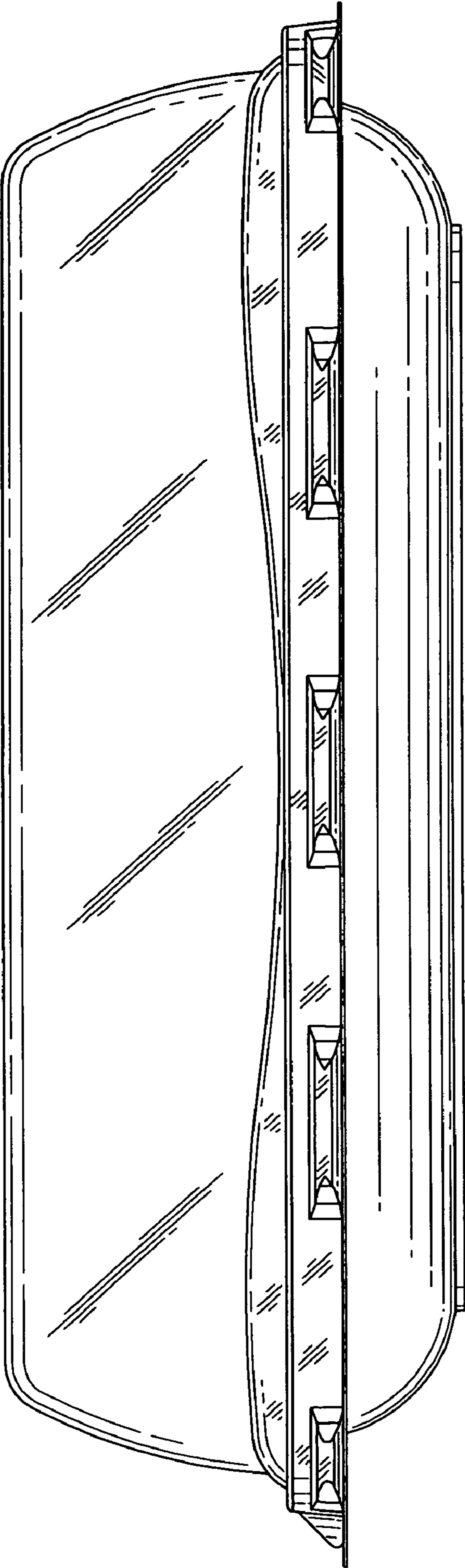

FIG. 3

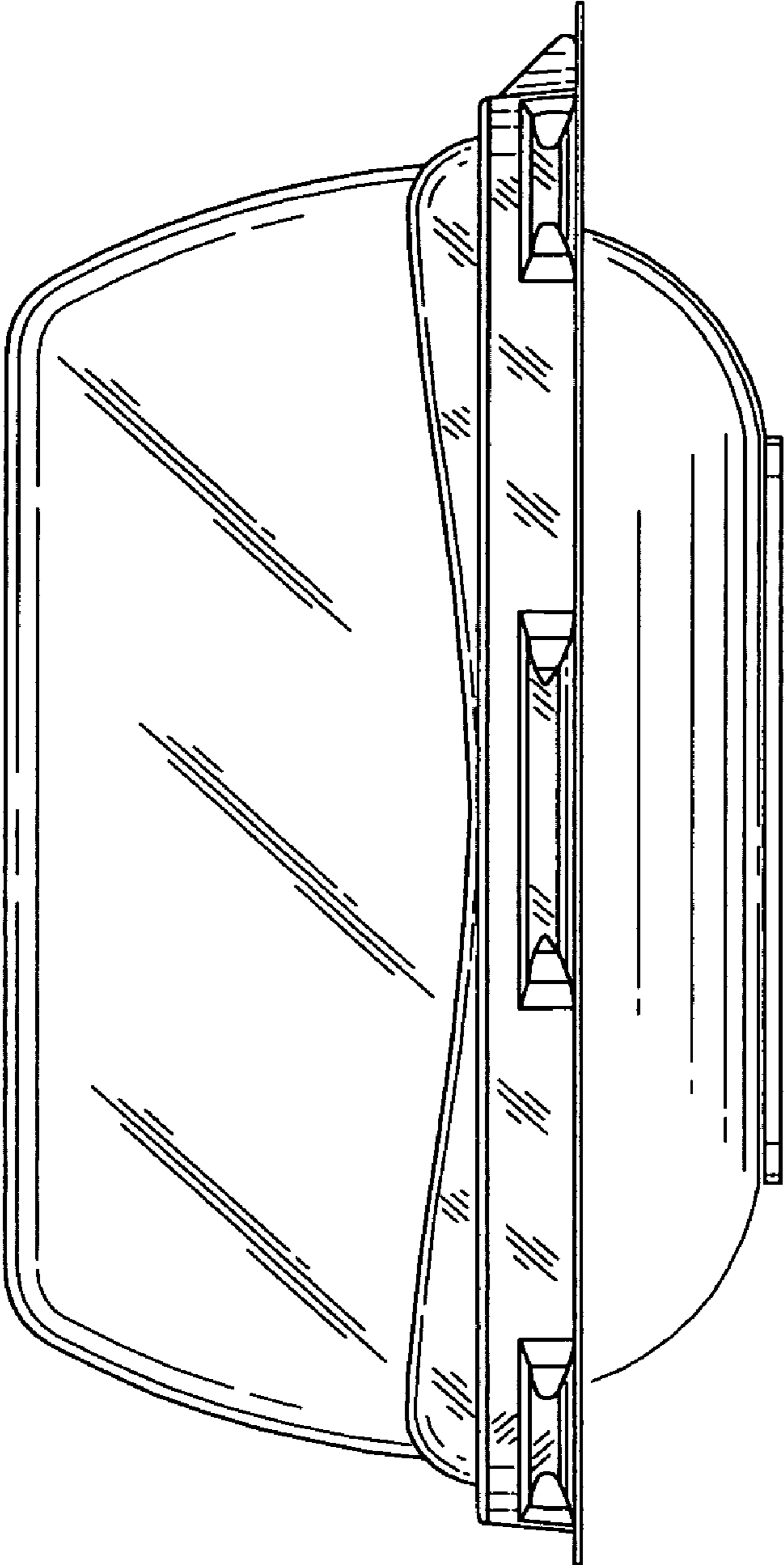

FIG. 4

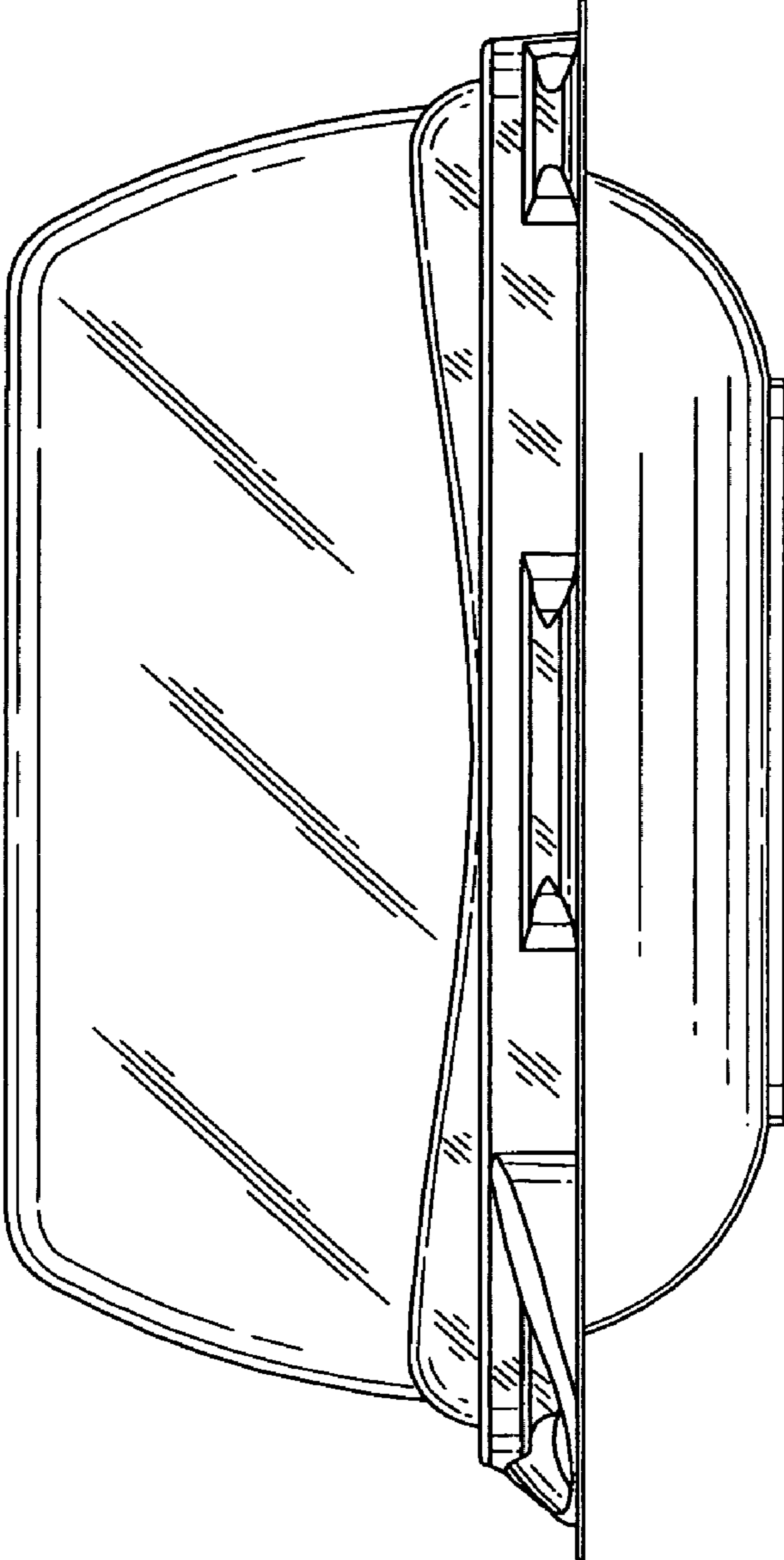

FIG. 5

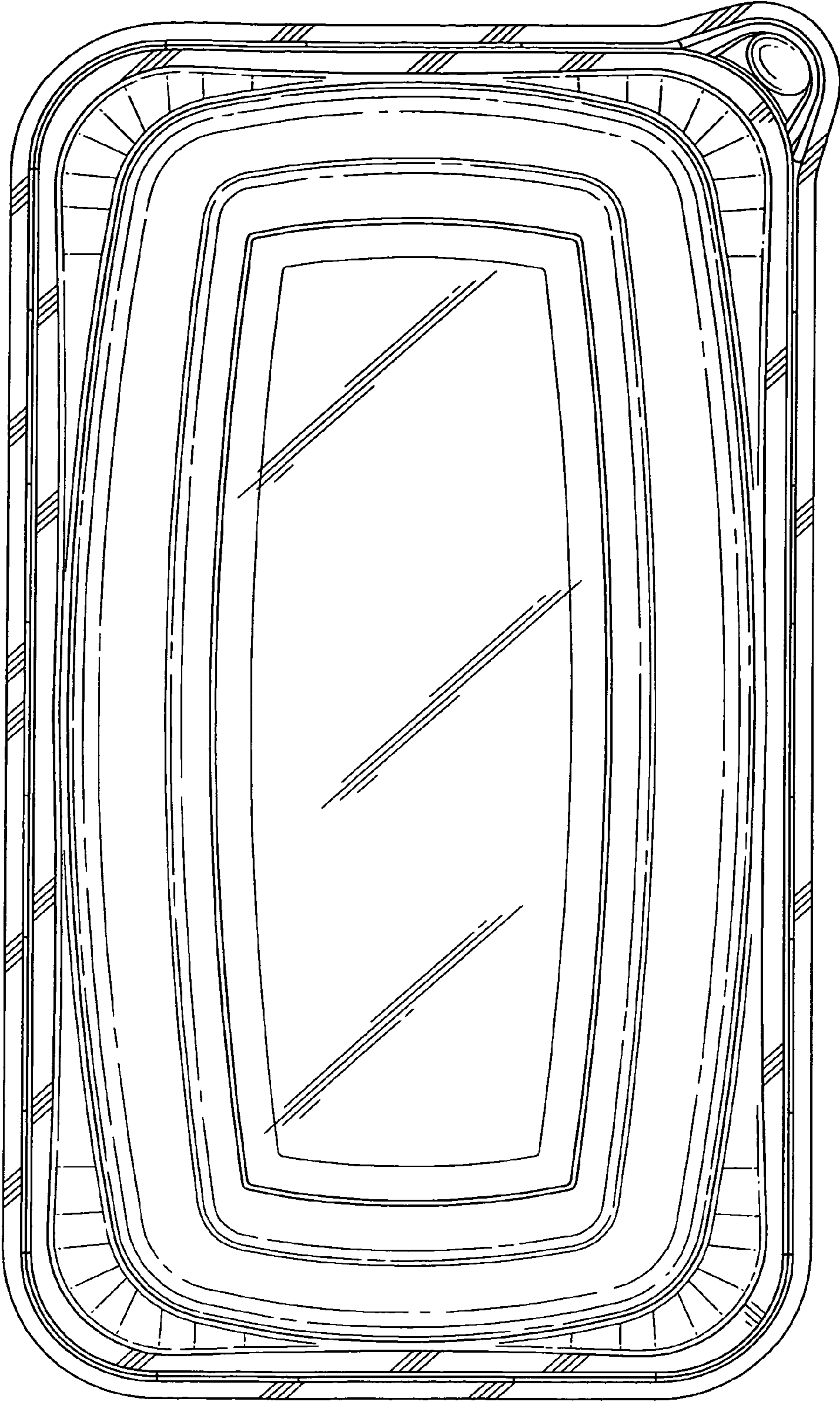

FIG. 6



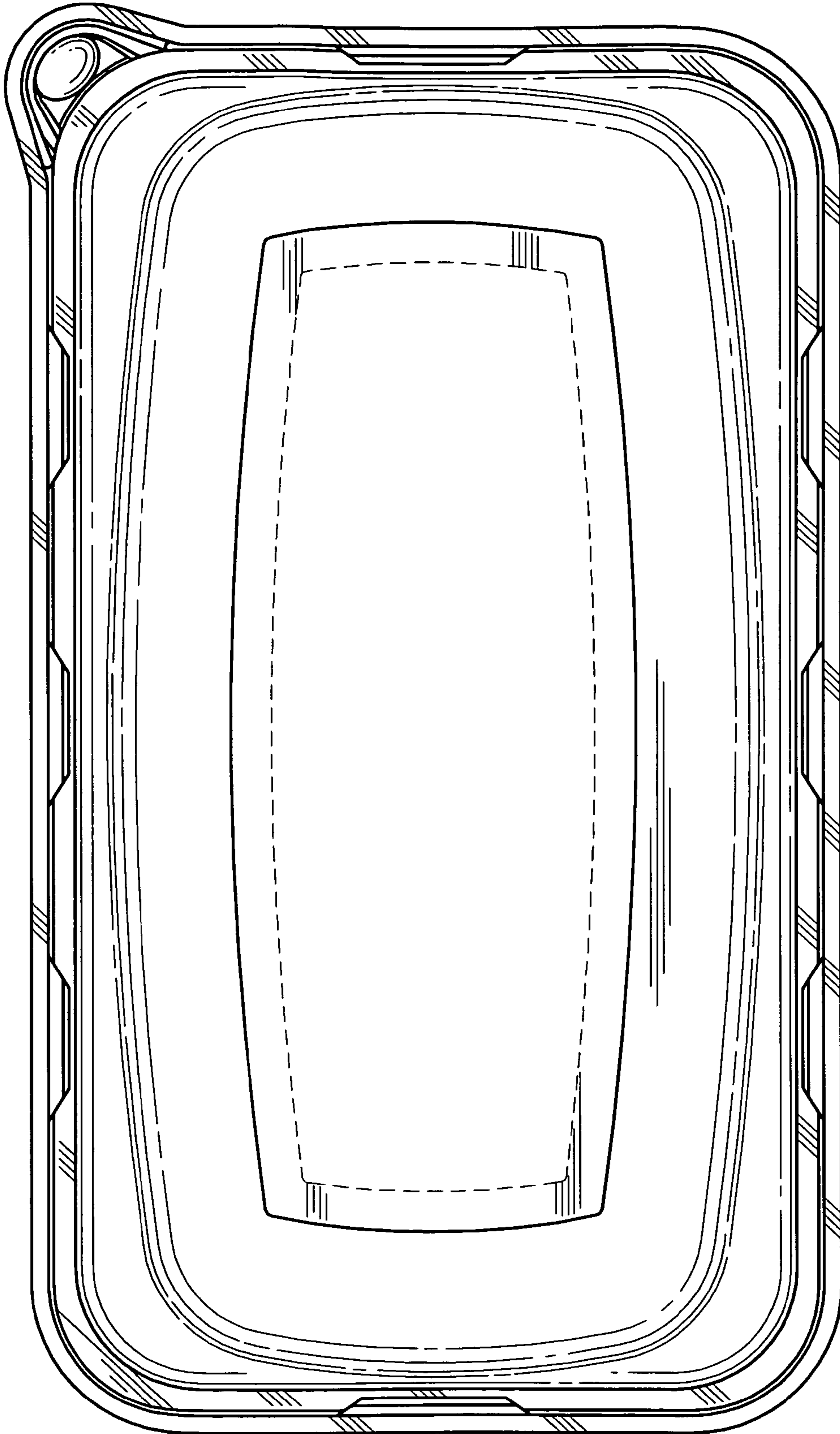

FIG. 7

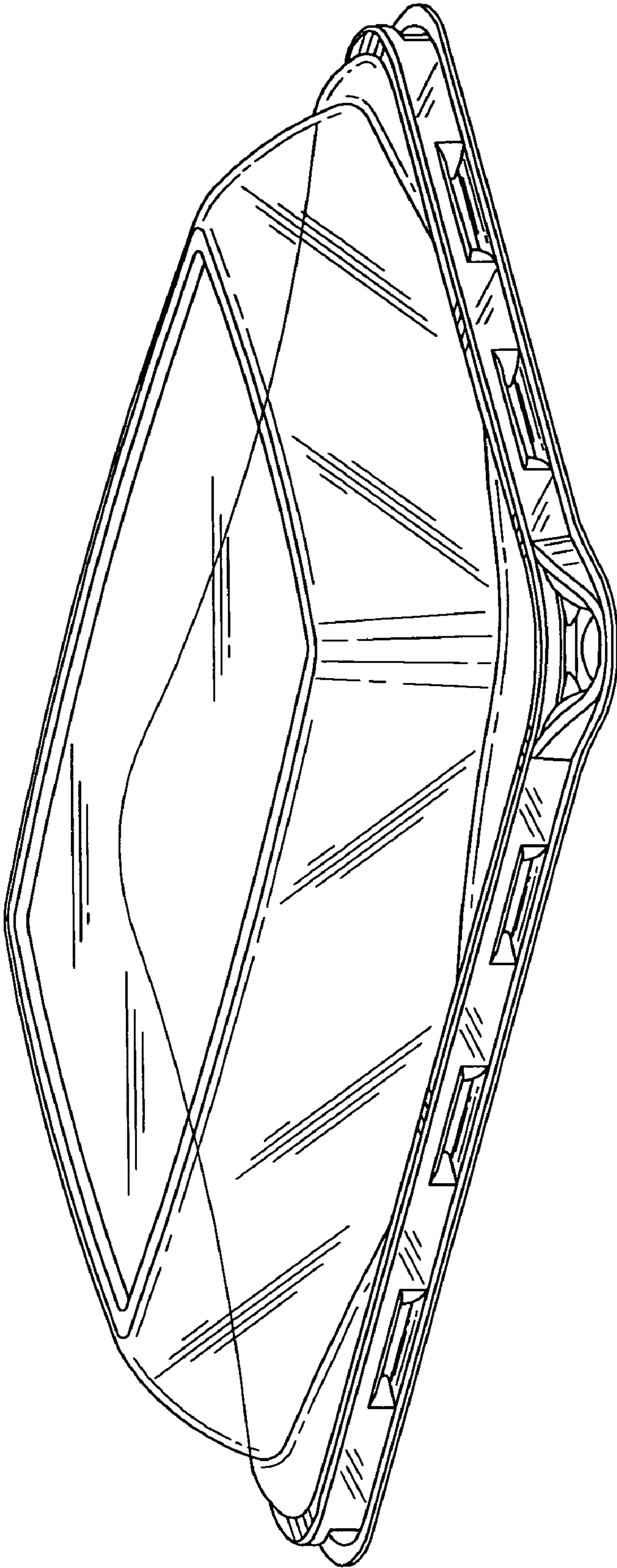

FIG. 8

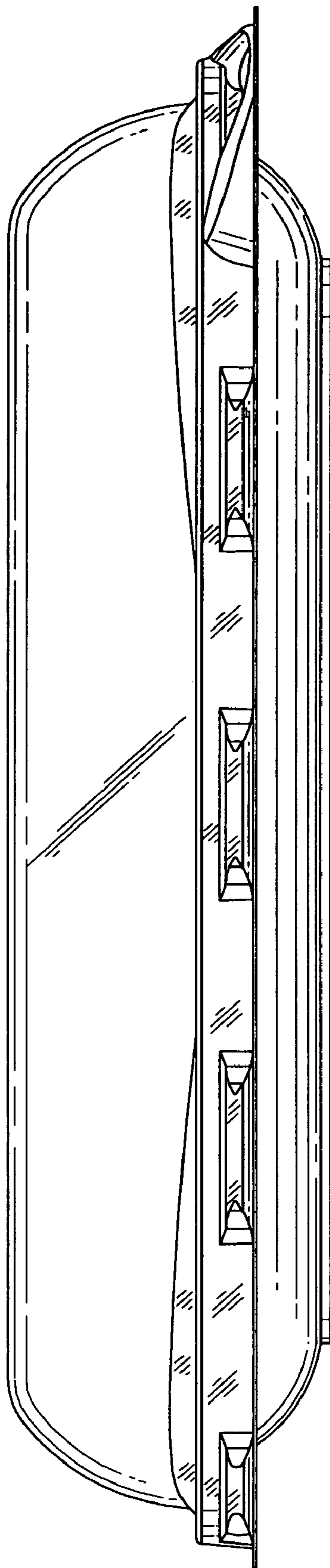

FIG. 9

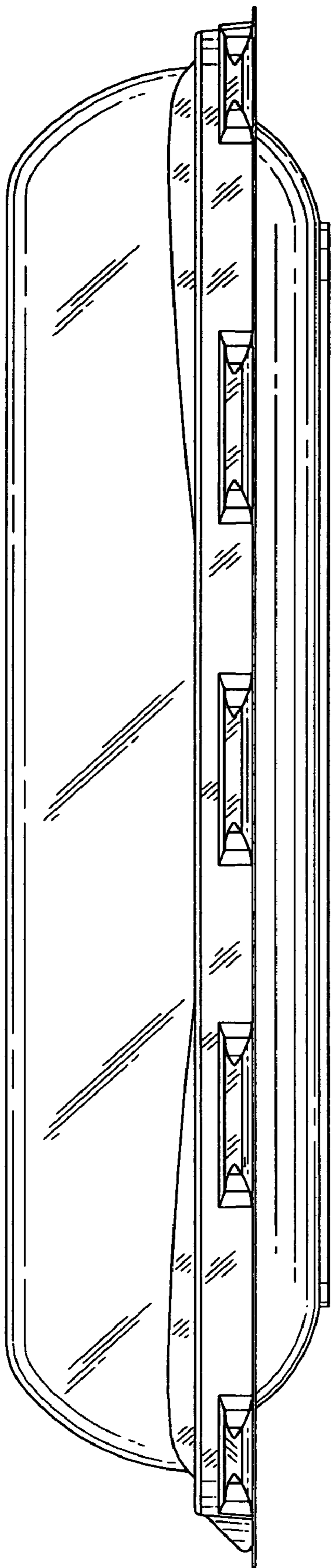

FIG. 10

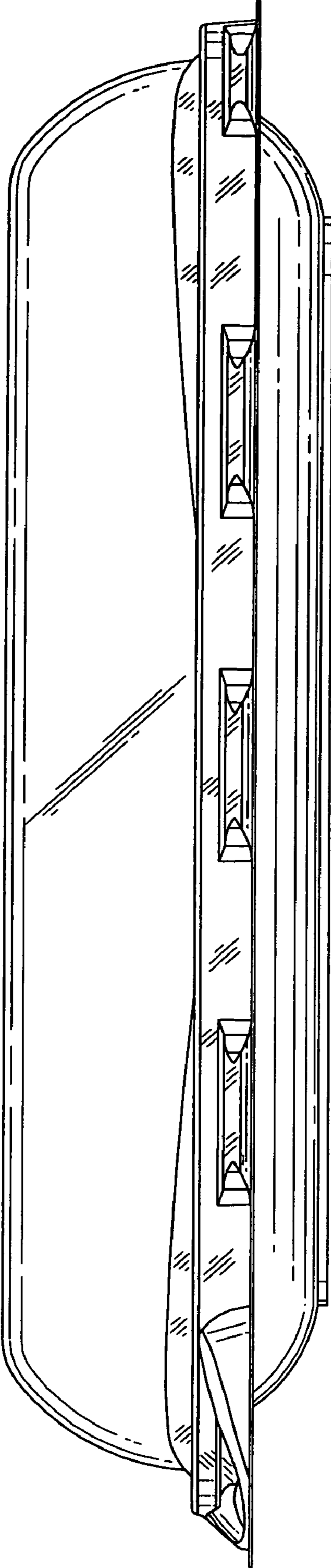

FIG. 11

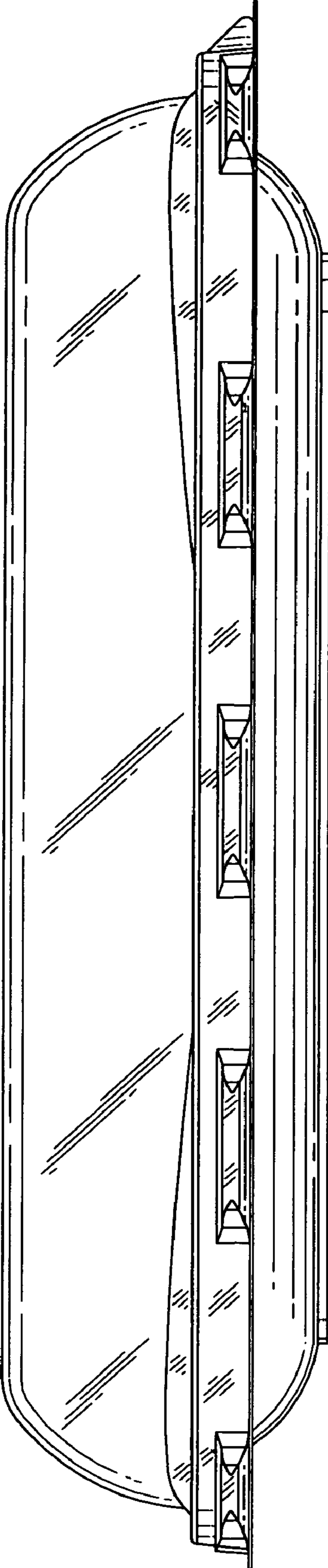

FIG. 12

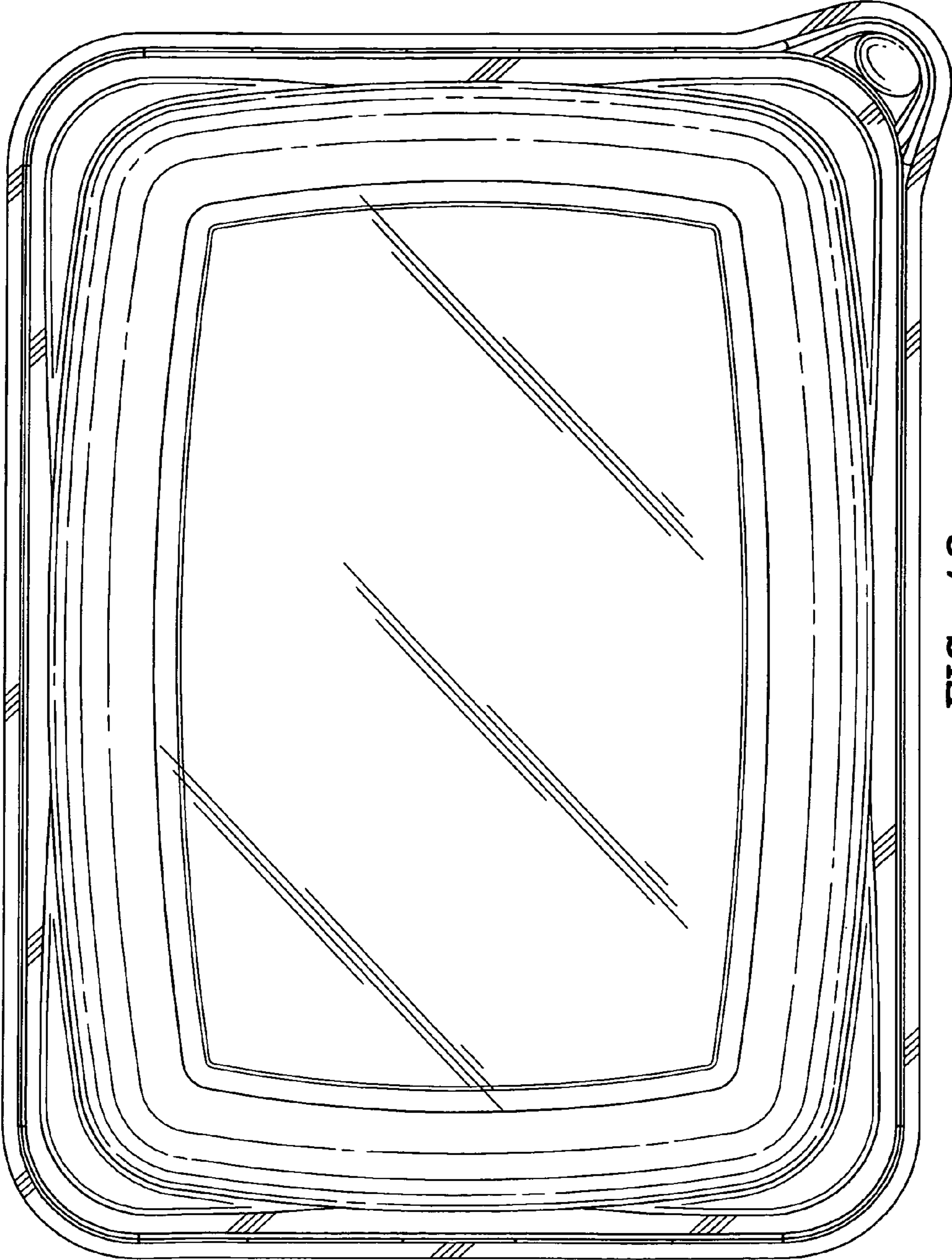

FIG. 13

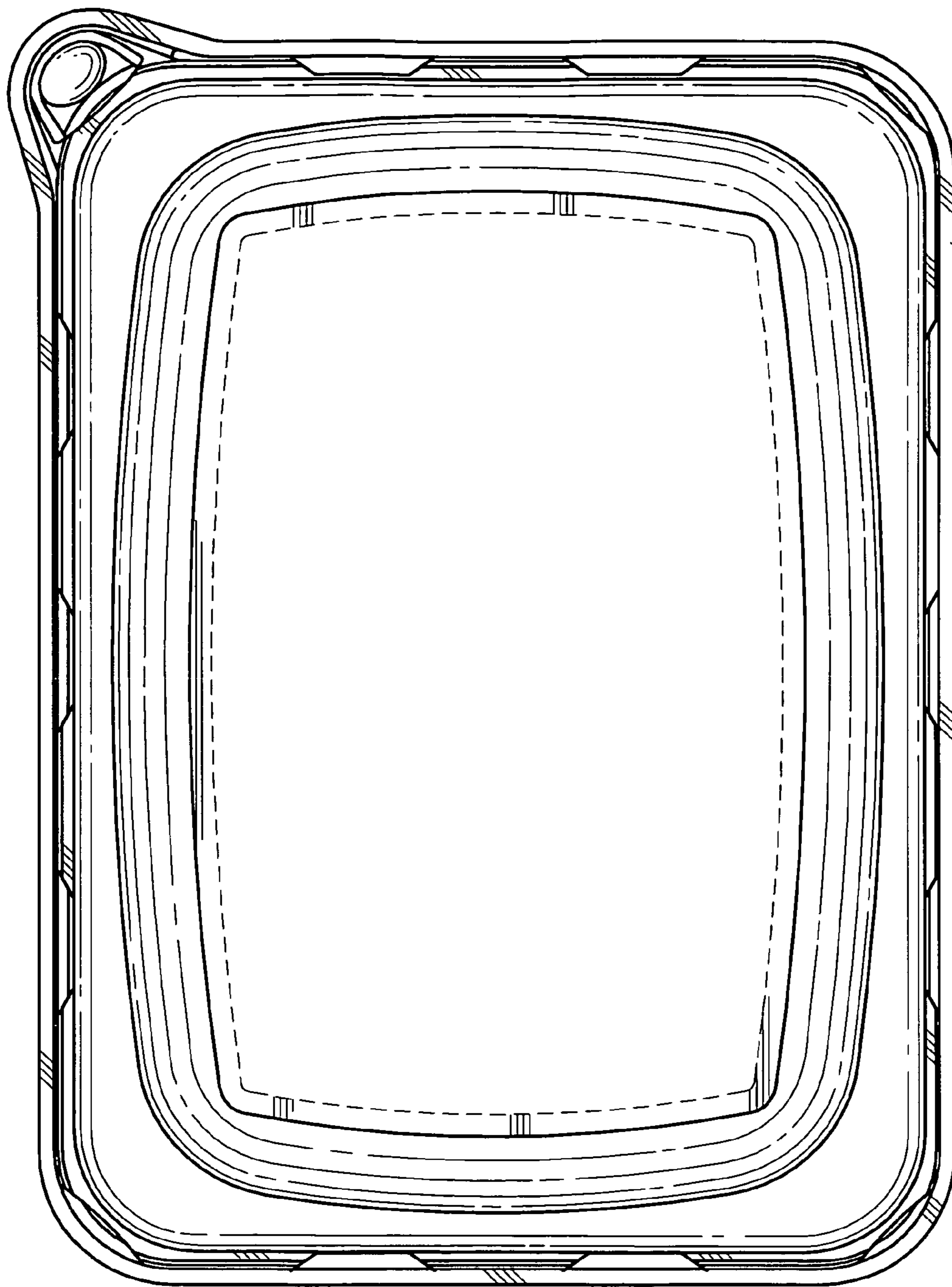
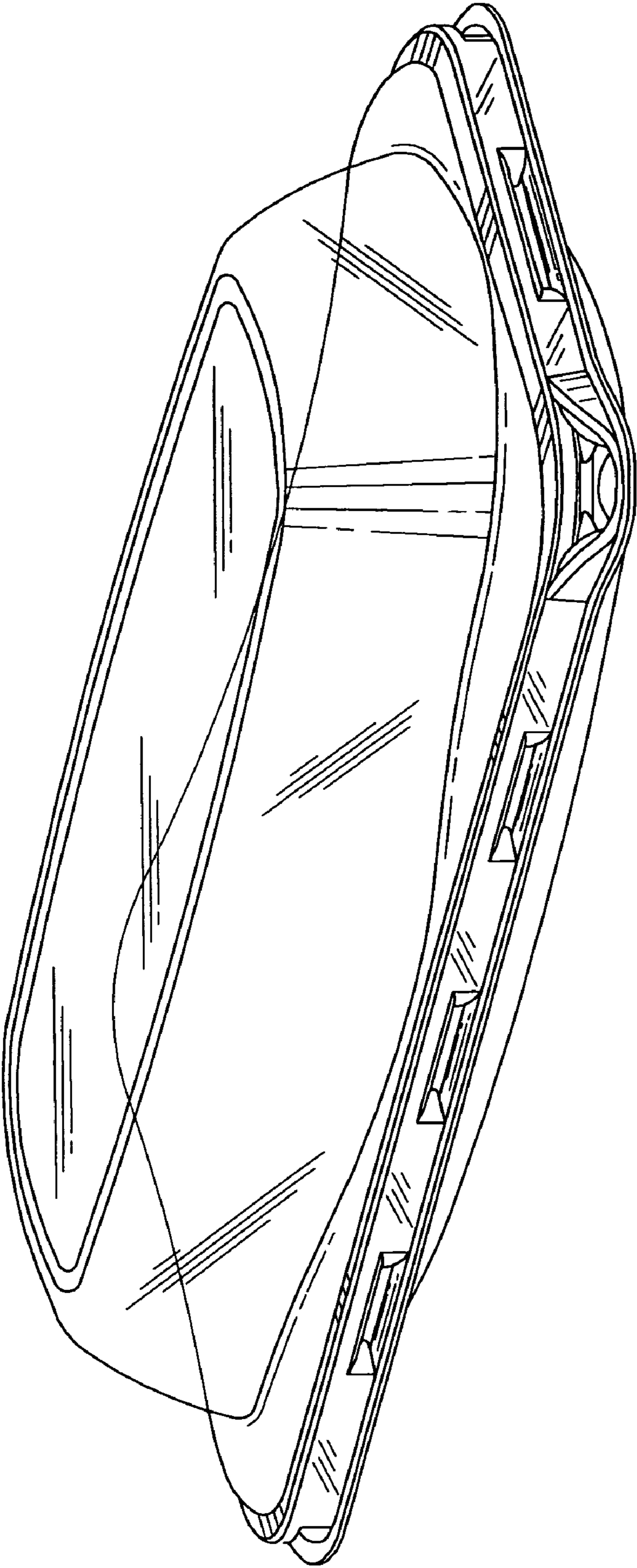

FIG. 14





**FIG. 15**

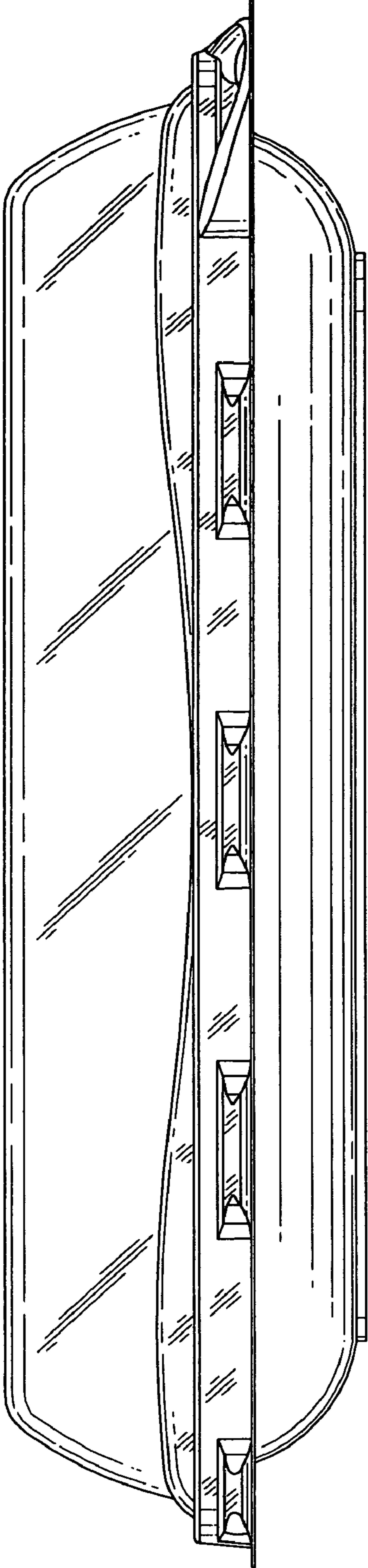

FIG. 16

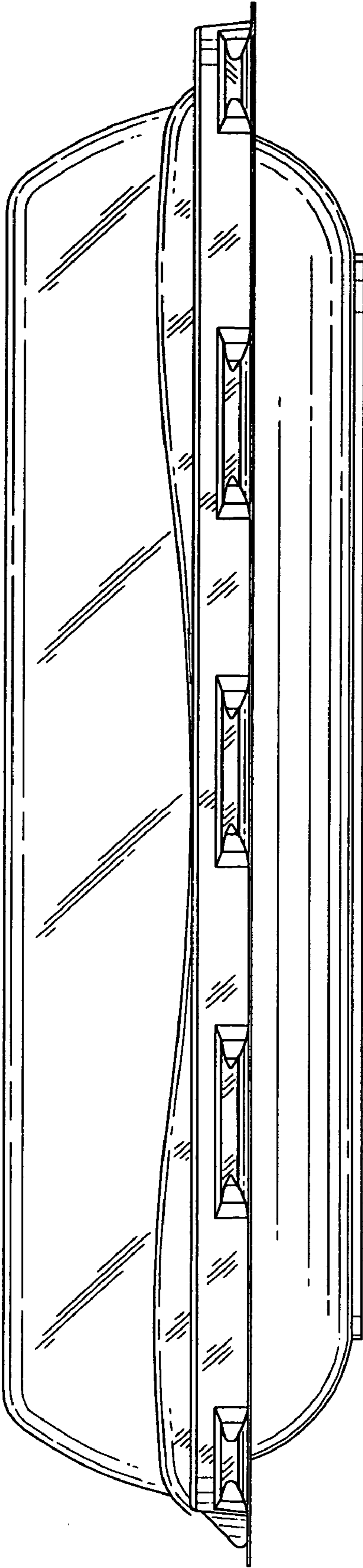

FIG. 17

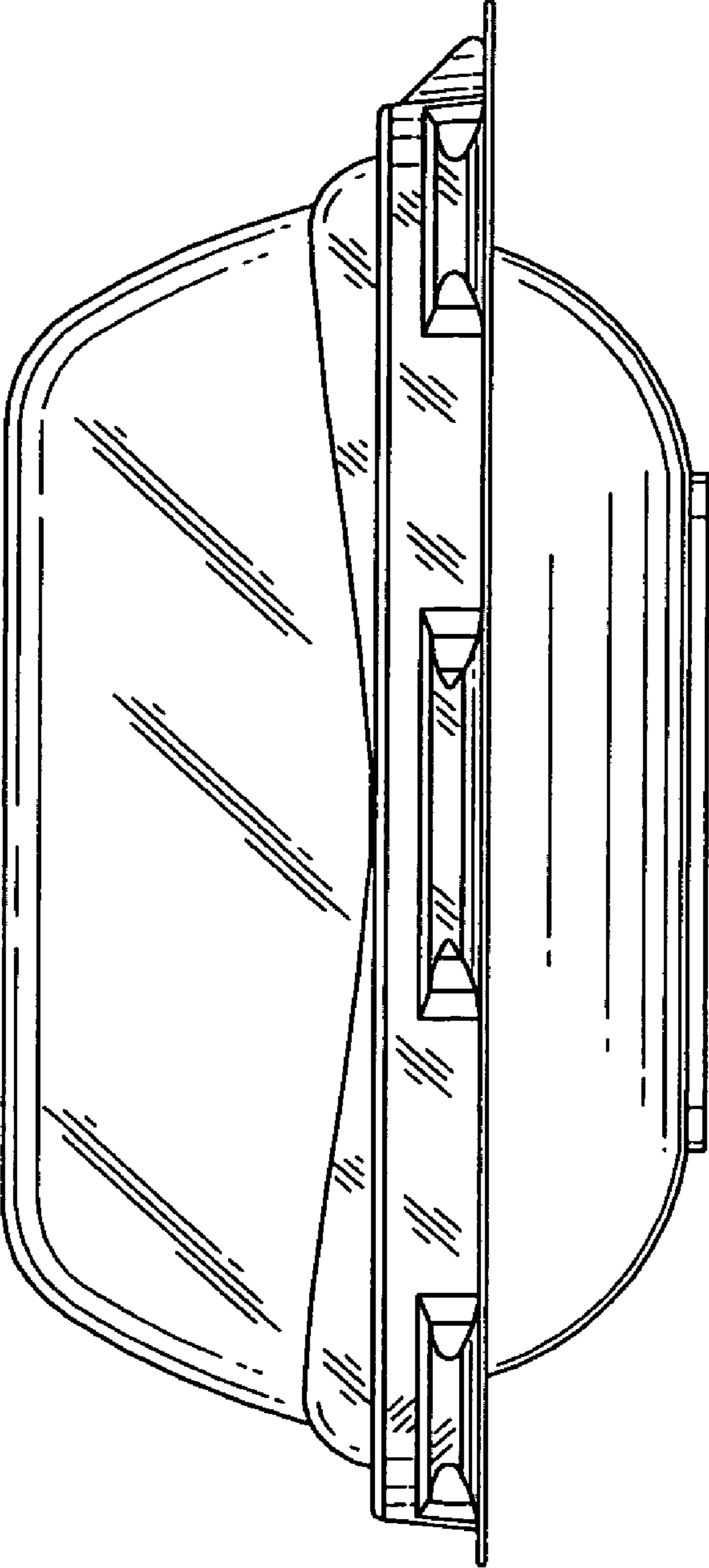
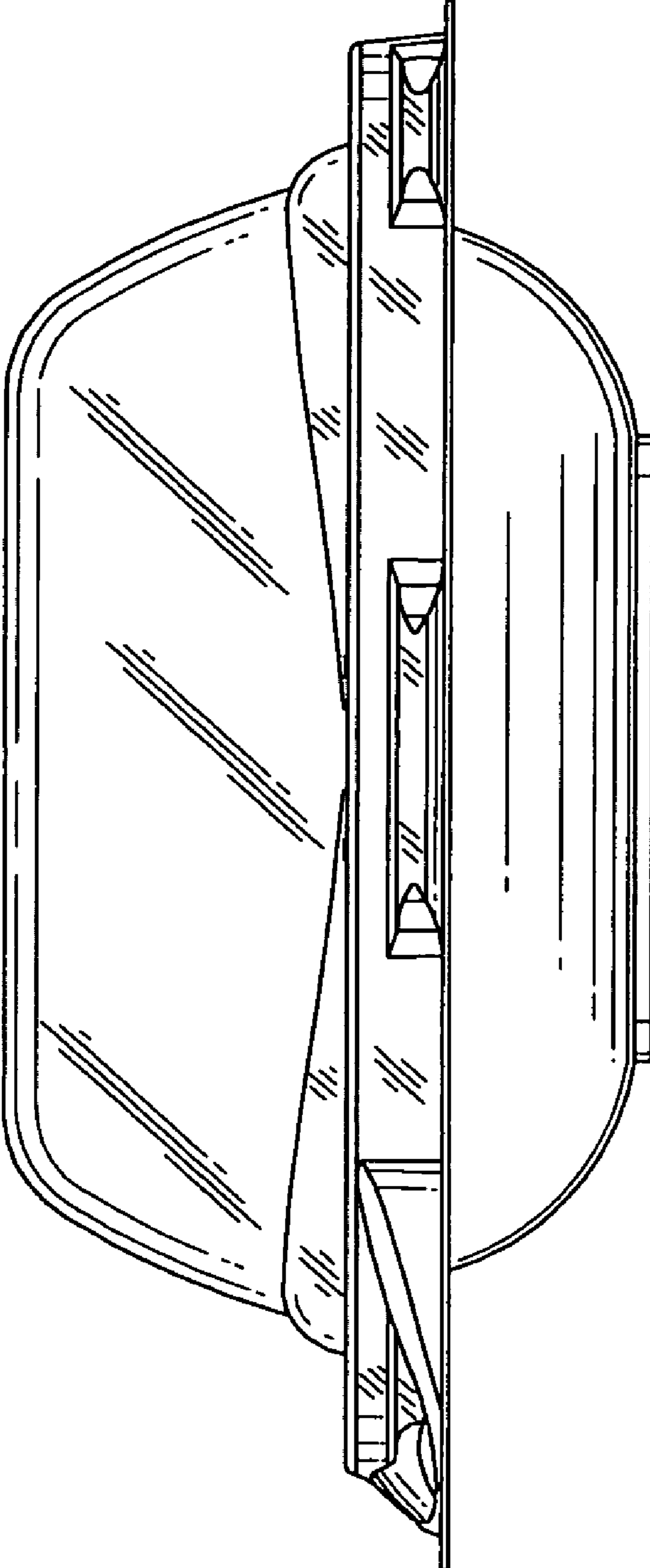

FIG. 18



**FIG. 19**

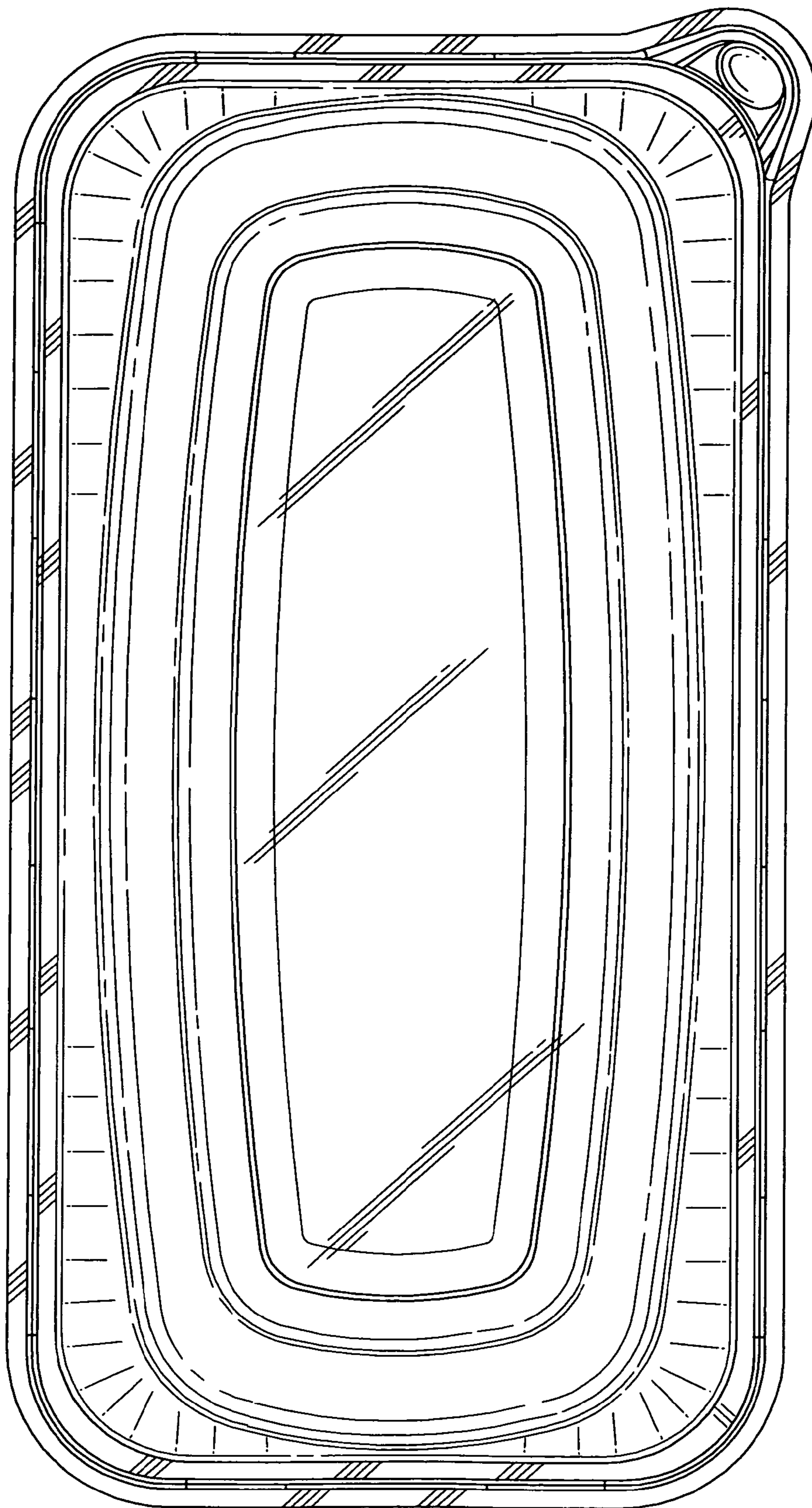

FIG. 20

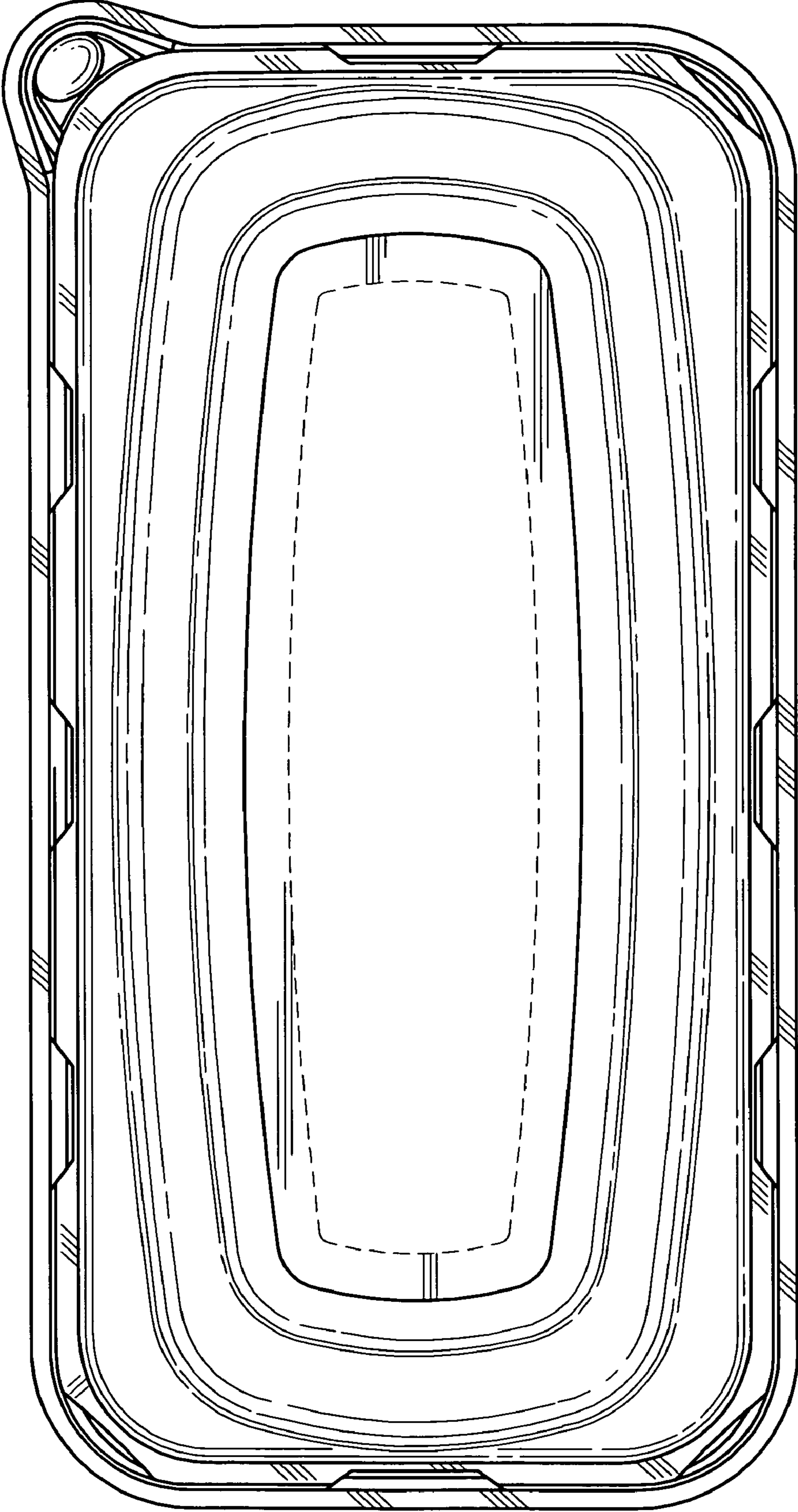

FIG. 21