



US00D592011S

(12) **United States Design Patent**
Fujimoto et al.

(10) **Patent No.:** **US D592,011 S**
(45) **Date of Patent:** **** May 12, 2009**

- (54) **CUP TO ASSIST THE TAKING OF MEDICINES ORALLY**
- (75) Inventors: **Takashi Fujimoto**, Toyama (JP); **Saichi Ono**, Tokyo (JP); **Kazumi Ishii**, Tokyo (JP)
- (73) Assignee: **Kureha Corporation**, Tokyo (JP)
- (**) Term: **14 Years**
- (21) Appl. No.: **29/274,555**
- (22) Filed: **May 1, 2007**
- (51) **LOC (9) Cl.** **07-01**
- (52) **U.S. Cl.** **D7/509; D7/316**
- (58) **Field of Classification Search** D7/691, D7/316, 317, 598, 509; D23/209; 222/494; 220/254.4, 703; 215/DIG. 7, 277, 311; D24/224, D24/197, 122, 121, 119; D10/46.2; 206/538; 604/78
See application file for complete search history.

- D313,555 S * 1/1991 Jordi D9/424
- D328,492 S * 8/1992 Mathis D24/121
- D404,663 S * 1/1999 Prindle D10/46.2
- D433,274 S * 11/2000 Babayan D7/361
- D433,866 S * 11/2000 Cautereels et al. D7/319
- 7,198,167 B2 * 4/2007 Marsden et al. 220/254.4
- D559,029 S * 1/2008 Gonzalez et al. D7/318
- D573,834 S * 7/2008 Iwasaki et al. D7/318
- D579,557 S * 10/2008 Washington D24/122
- D580,799 S * 11/2008 Curtin D10/46.2

* cited by examiner

Primary Examiner—Marianne Pandozzi
(74) *Attorney, Agent, or Firm*—Reed Smith LLP; Juan Carlos A. Marquez, Esq.

(57) **CLAIM**

The ornamental design for the cup to assist the taking of medicines orally, as shown and described.

DESCRIPTION

FIG. 1 is a right side view of a cup to assist the taking of medicines orally showing our new design;

FIG. 2 is a left side view thereof;

FIG. 3 is a top plan view thereof;

FIG. 4 is a bottom plan view thereof;

FIG. 5 is a front view thereof;

FIG. 6 is a rear view thereof;

FIG. 7 is a sectional view taken along line 7—7 of FIG. 3;

FIG. 8 is a sectional view taken along line 8—8 of FIG. 1;

FIG. 9 is a top perspective view thereof;

FIG. 10 is an environmental top plan view thereof; and,

FIG. 11 is an environmental top plan view in use thereof.

1 Claim, 11 Drawing Sheets

(56) **References Cited**

U.S. PATENT DOCUMENTS

- D127,970 S * 7/1941 Myers D10/46.2
- D194,622 S * 2/1963 Jones D7/317
- 3,302,644 A * 2/1967 Kennedy et al. 604/78
- D215,749 S * 10/1969 Smith D7/317
- 3,858,767 A * 1/1975 Borin 222/494
- 4,135,512 A * 1/1979 Godsey 604/78
- D255,206 S * 6/1980 Darnell D7/319
- D255,207 S * 6/1980 Darnell D7/319
- 4,210,141 A * 7/1980 Brockman et al. 604/78
- D274,778 S * 7/1984 Reece et al. D7/691
- 4,572,373 A * 2/1986 Johansson 206/515
- D285,515 S * 9/1986 Papciak D7/509
- D310,614 S * 9/1990 Pozzi D7/317

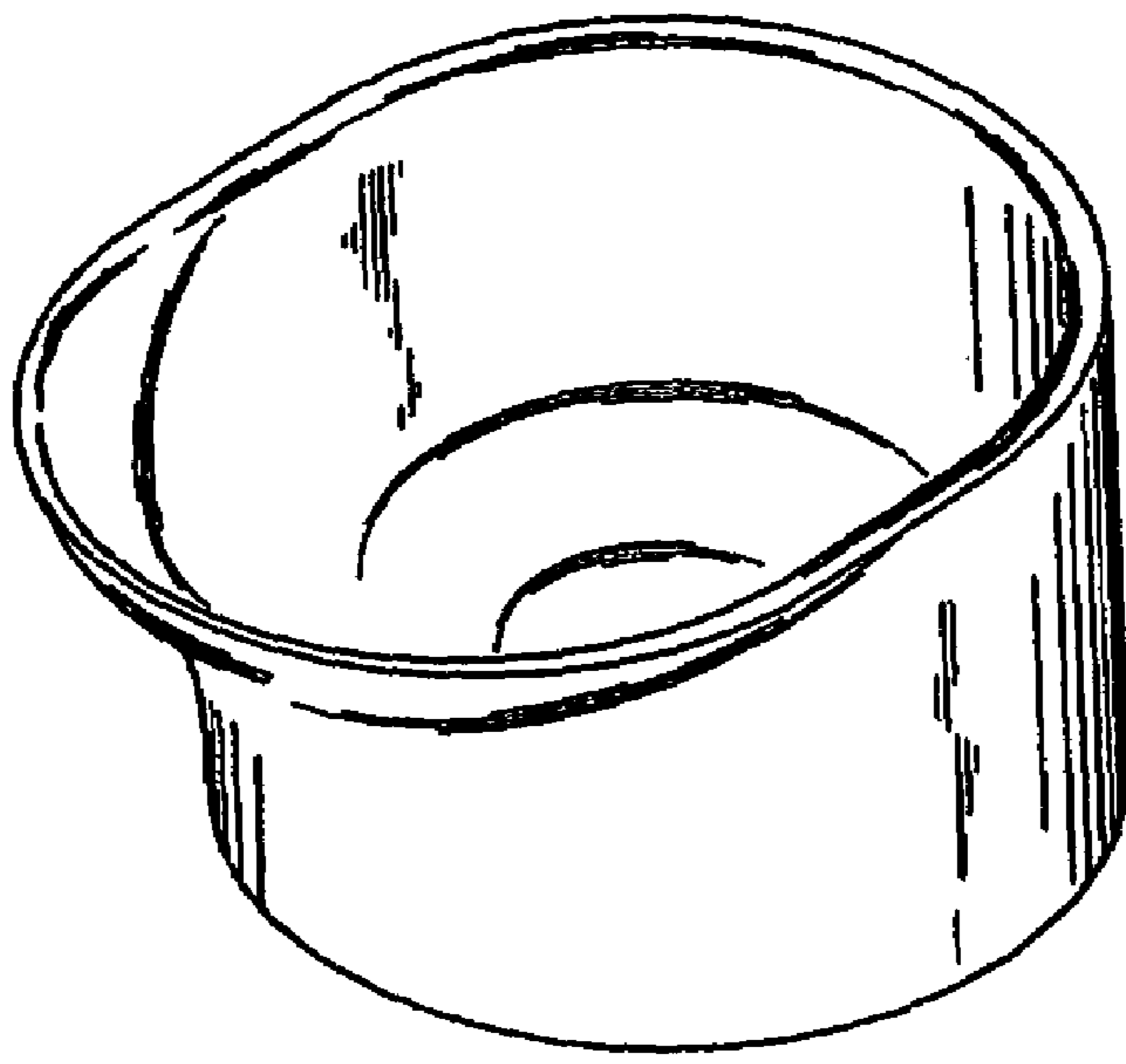

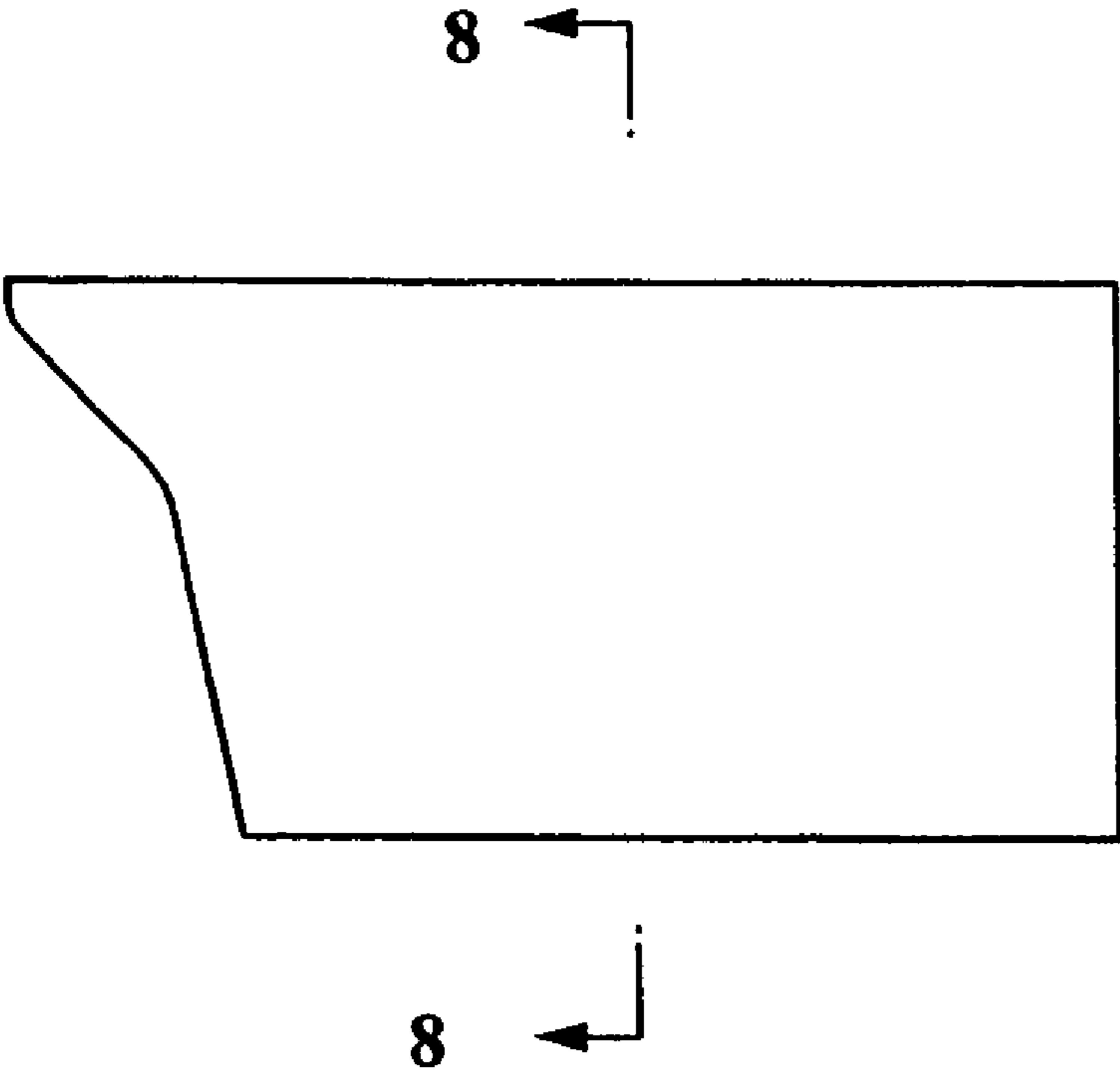

FIGURE 1

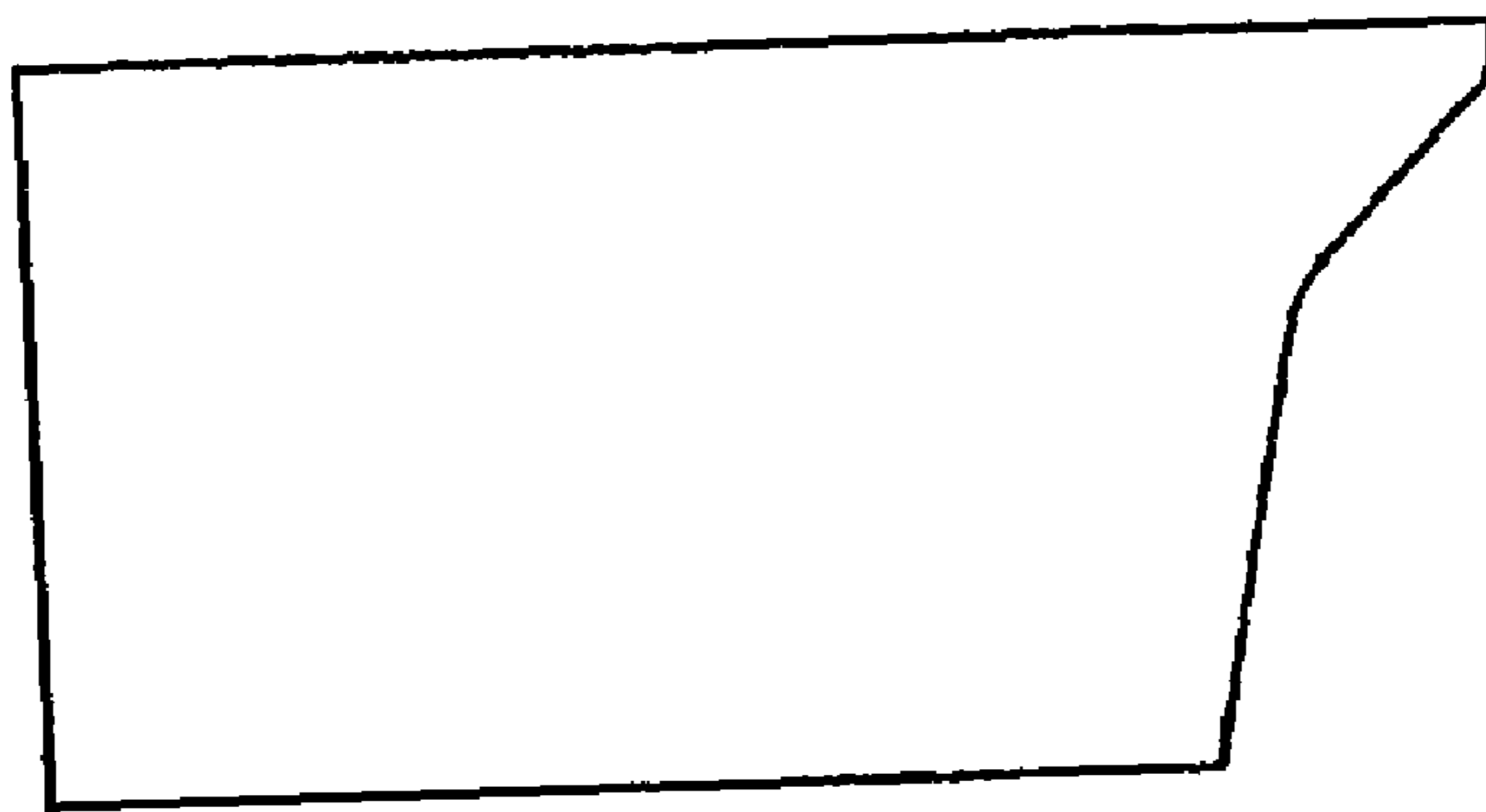

FIGURE 2

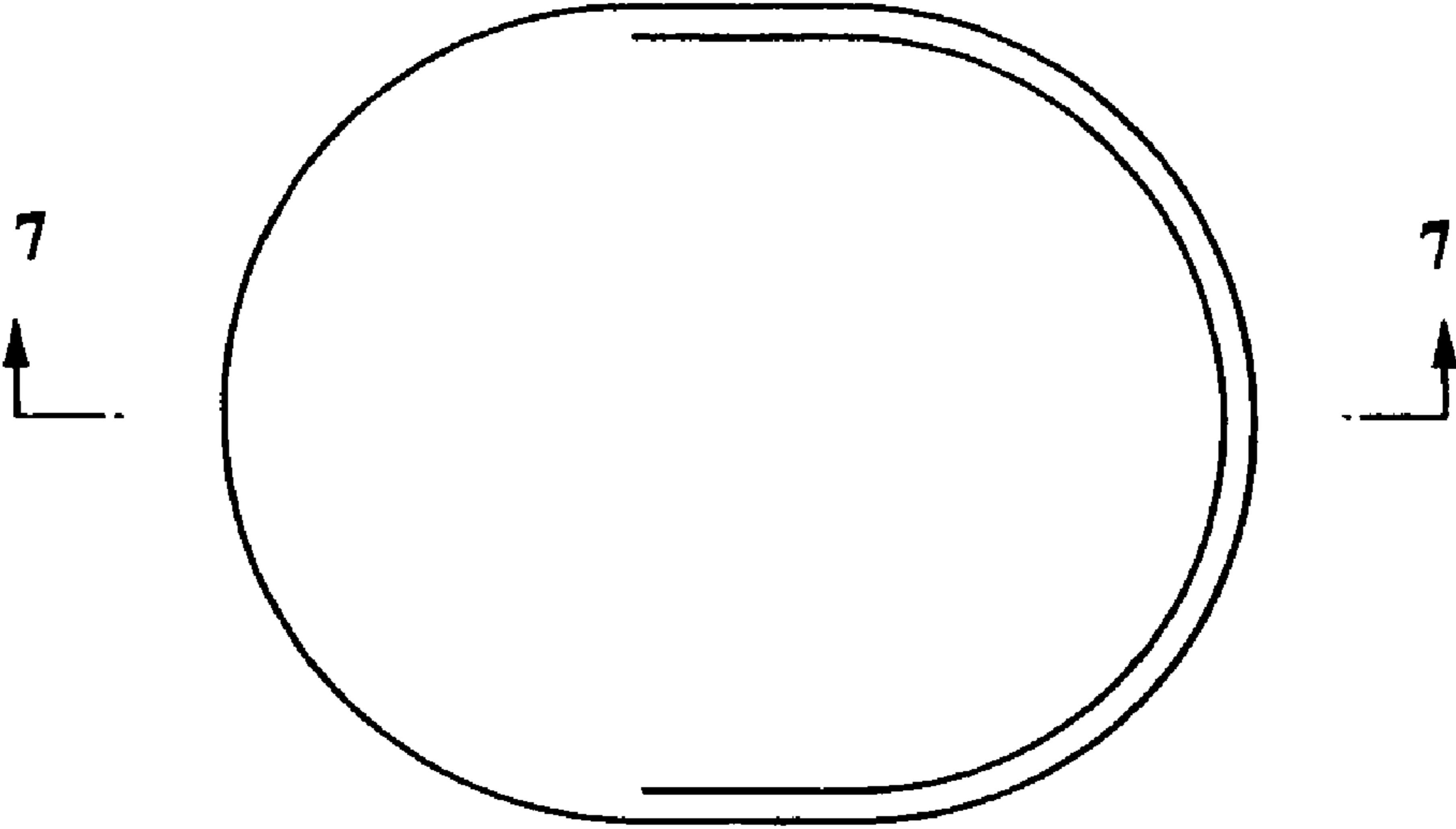

FIGURE 3

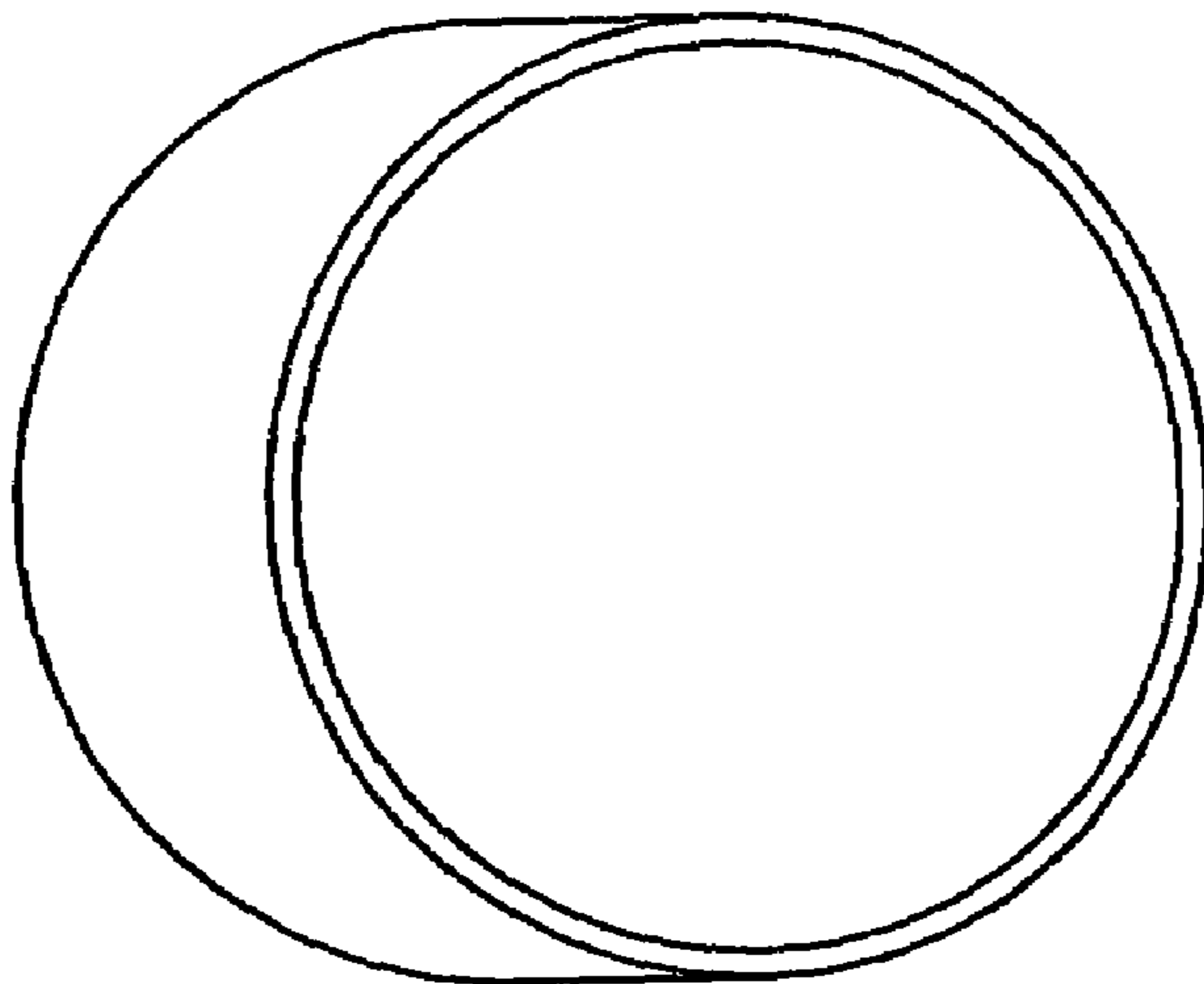

FIGURE 4

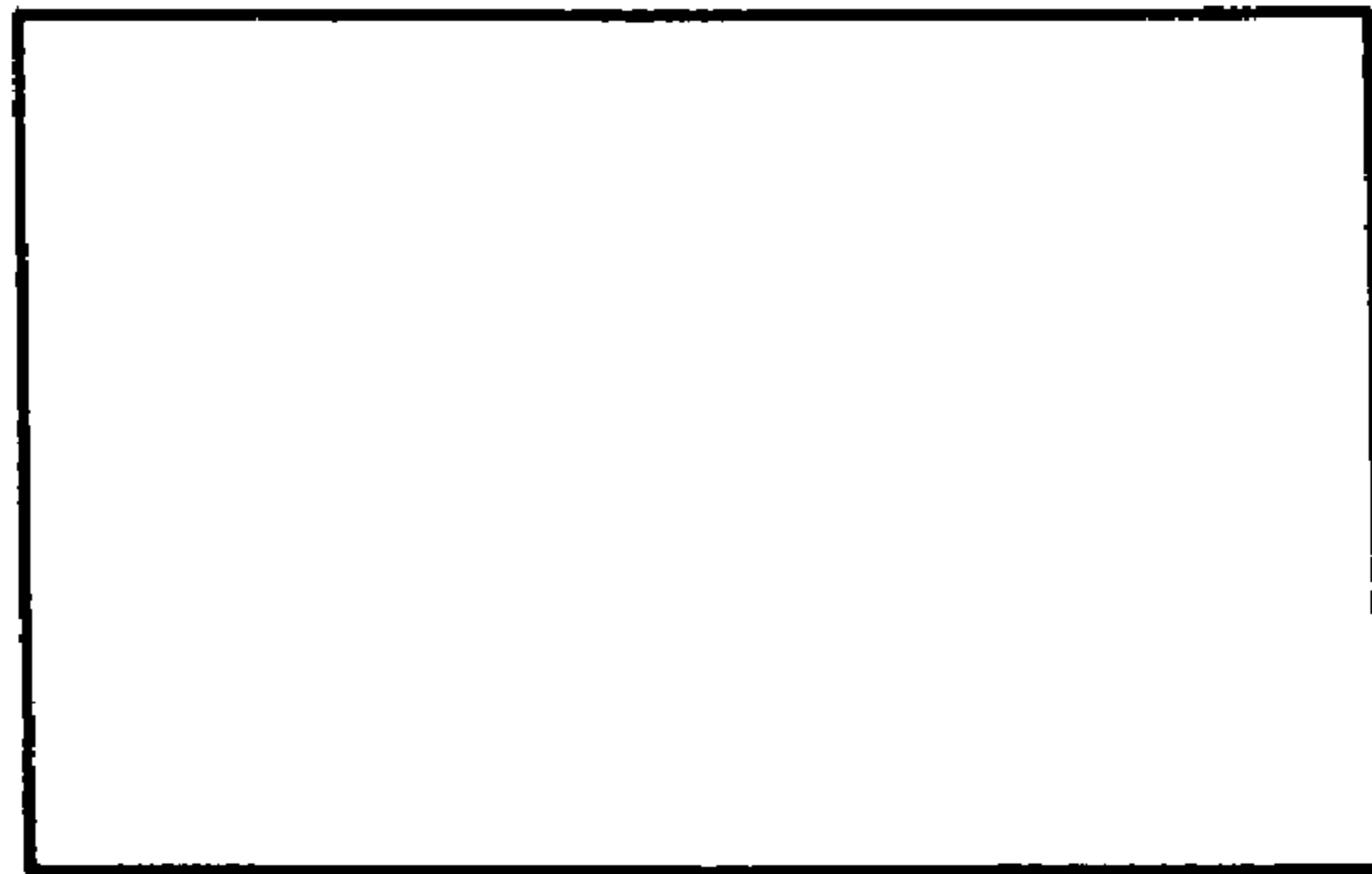

FIGURE 5

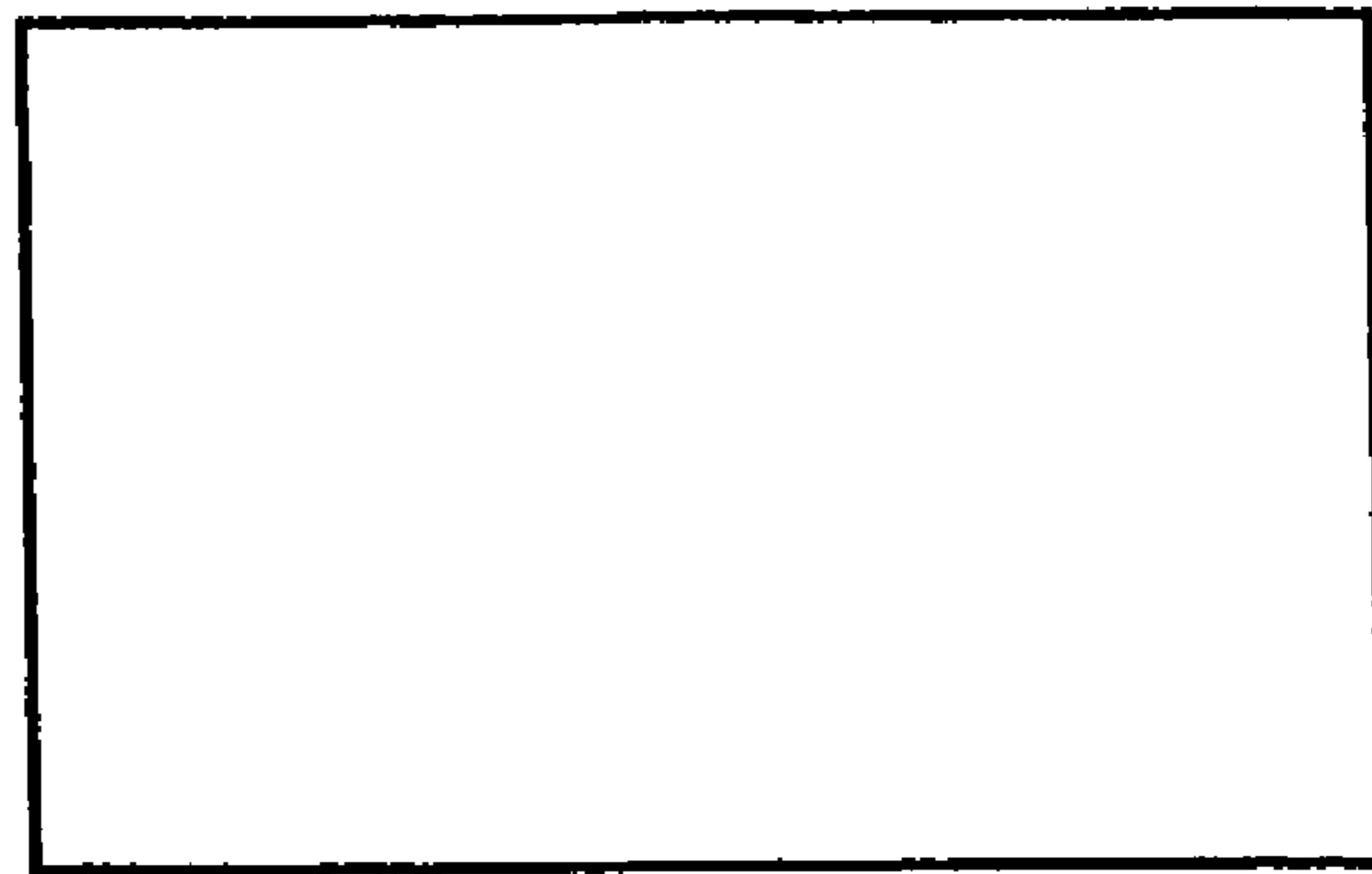

FIGURE 6

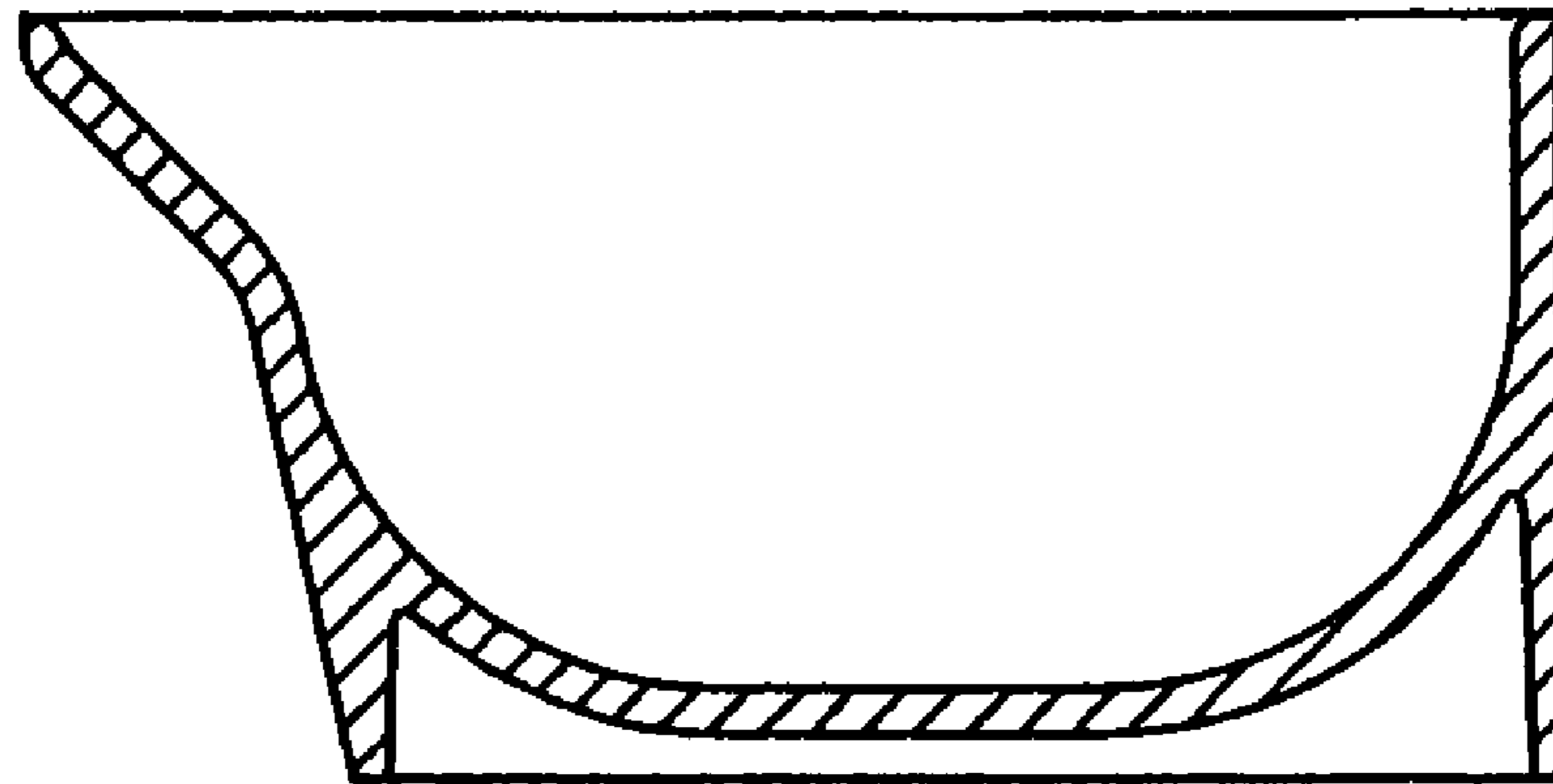

FIGURE 7

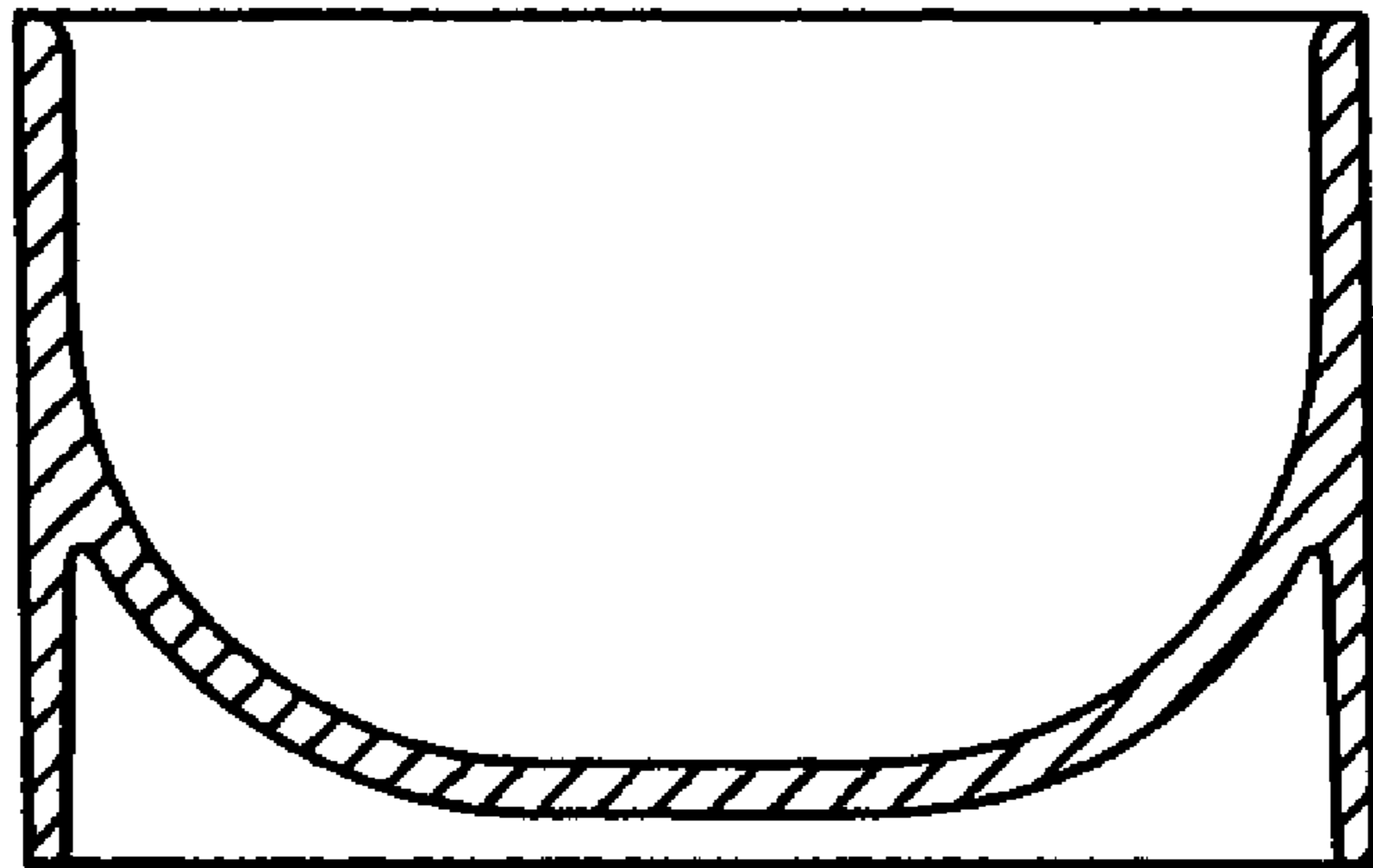

FIGURE 8

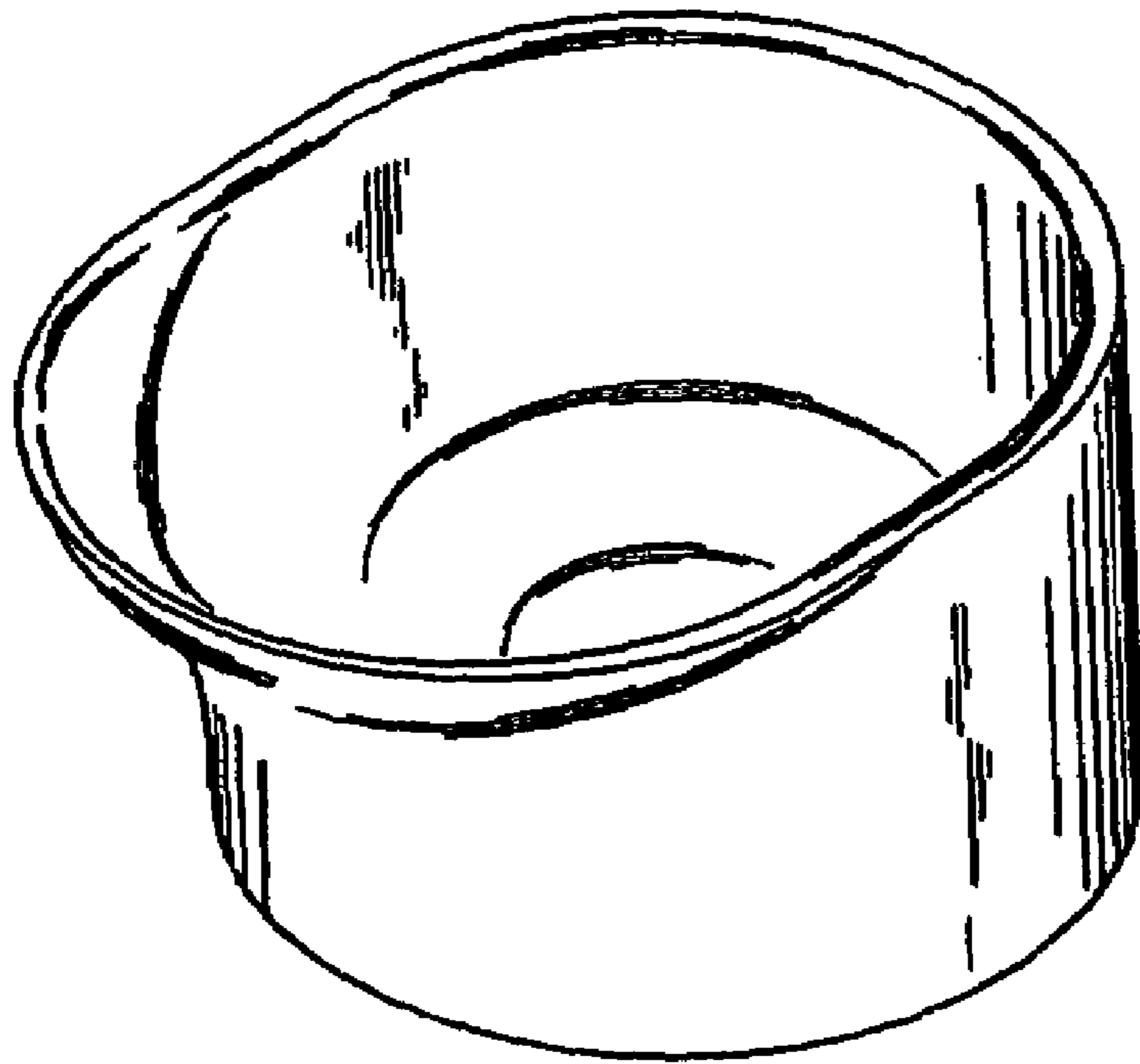

FIGURE 9

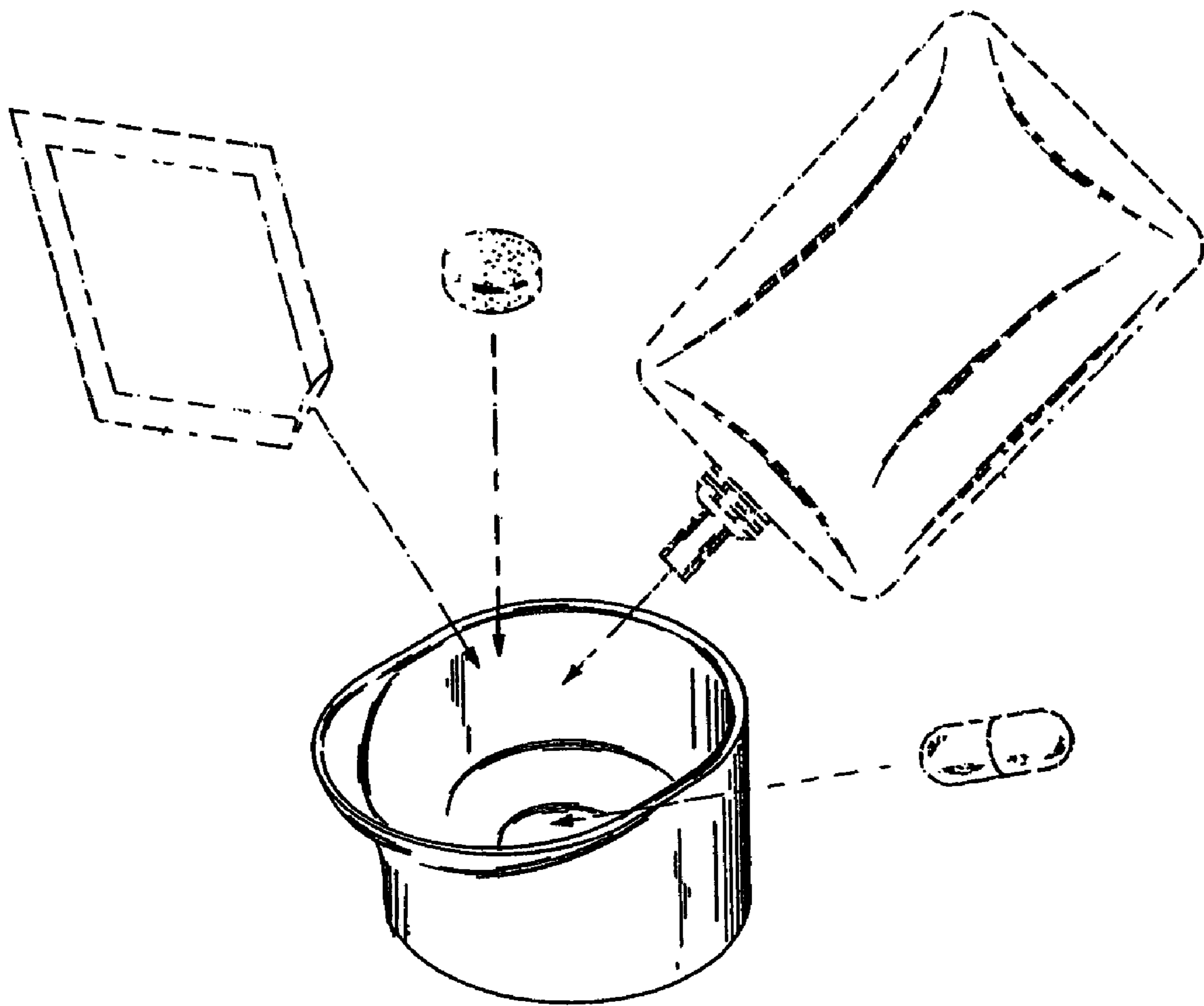

FIGURE 10

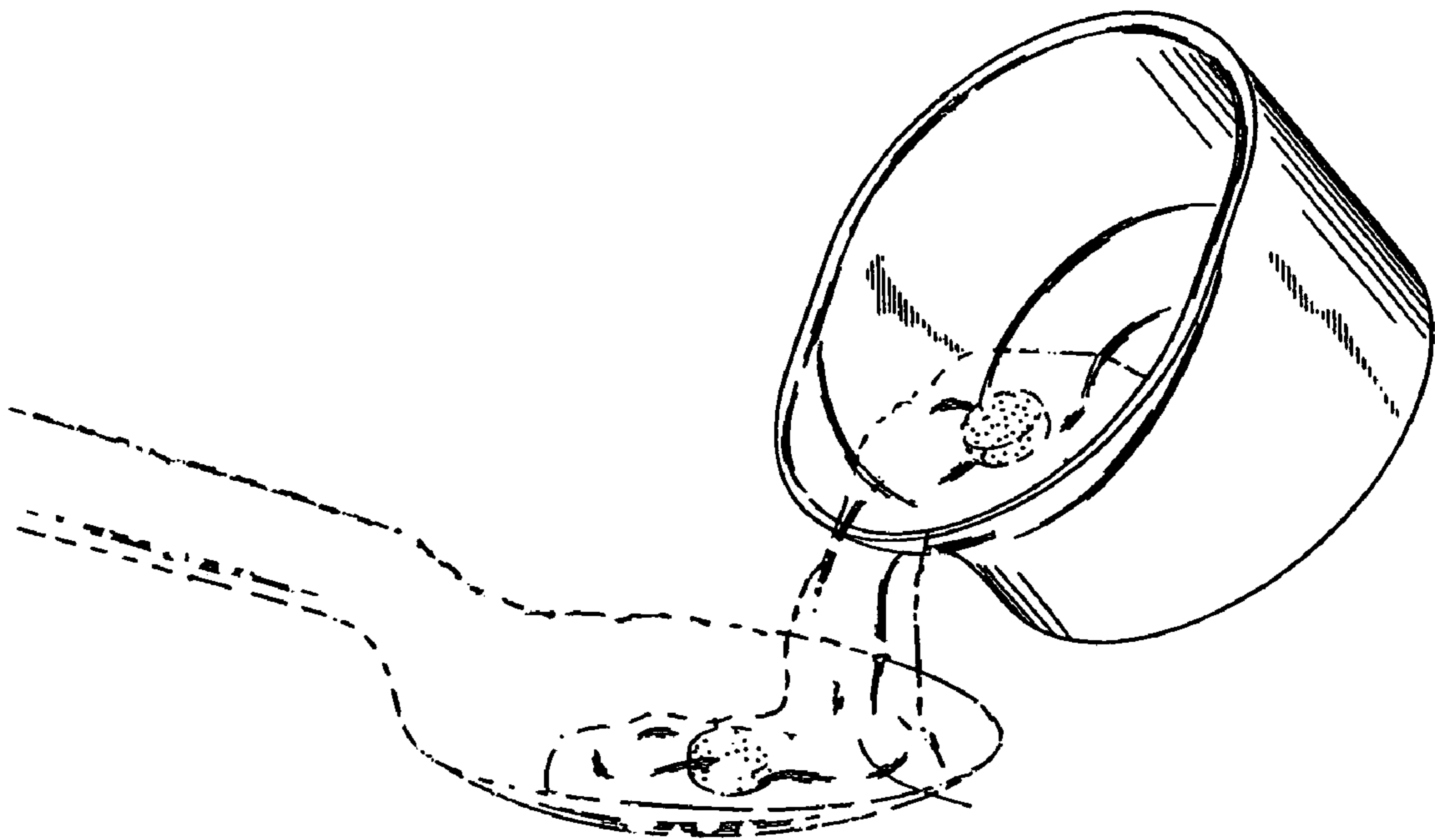

FIGURE 11