



US00D591918S

(12) **United States Design Patent**  
**Vagges**

(10) **Patent No.:** **US D591,918 S**

(45) **Date of Patent:** **\*\* May 5, 2009**

(54) **VACUUM CLEANER**

(75) Inventor: **Christopher Vagges**, Halesowen (GB)

(73) Assignee: **Grey Technology Limited** (GB)

(\*\*) Term: **14 Years**

(21) Appl. No.: **29/310,495**

(22) Filed: **Aug. 22, 2008**

(30) **Foreign Application Priority Data**

Jul. 7, 2008 (EM) ..... 000965637

(51) **LOC (9) Cl.** ..... **15-05**

(52) **U.S. Cl.** ..... **D32/22**

(58) **Field of Classification Search** ..... D32/22,  
D32/30-31; 15/320, 329, 335, 340.2, 347,  
15/350-353, 361, 363, 410, 412, 414, 327.1,  
15/327.2, 327.4, 327.6, 415.1, 411; 55/345,  
55/DIG. 3, 336, 337, 429, 343, 433, 418;  
95/271; 301/7, 63.101; 280/78, 47.31, 205

See application file for complete search history.

(56) **References Cited**

**U.S. PATENT DOCUMENTS**

D380,882 S \* 7/1997 Rorke et al. .... D32/22

D398,097 S \* 9/1998 Murphy et al. .... D32/22  
D426,356 S \* 6/2000 Tsuruha ..... D32/22  
D429,392 S \* 8/2000 Maruyama et al. .... D32/22  
D444,277 S \* 6/2001 Santiago ..... D32/31  
D507,387 S \* 7/2005 Jacobs ..... D32/22  
D561,959 S \* 2/2008 Hahn ..... D32/22

\* cited by examiner

*Primary Examiner*—Ruth McInroy

(74) *Attorney, Agent, or Firm*—Ira S. Dorman

(57) **CLAIM**

The ornamental design for a vacuum cleaner, as shown and described.

**DESCRIPTION**

FIG. 1 is a side elevational view of a vacuum cleaner showing my new design;

FIG. 2 is a side elevational view of the opposite side of FIG. 1;

FIG. 3 is a front elevational view thereof;

FIG. 4 is a rear elevational view thereof;

FIG. 5 is a top plan view thereof; and,

FIG. 6 is a bottom plan view thereof.

**1 Claim, 5 Drawing Sheets**

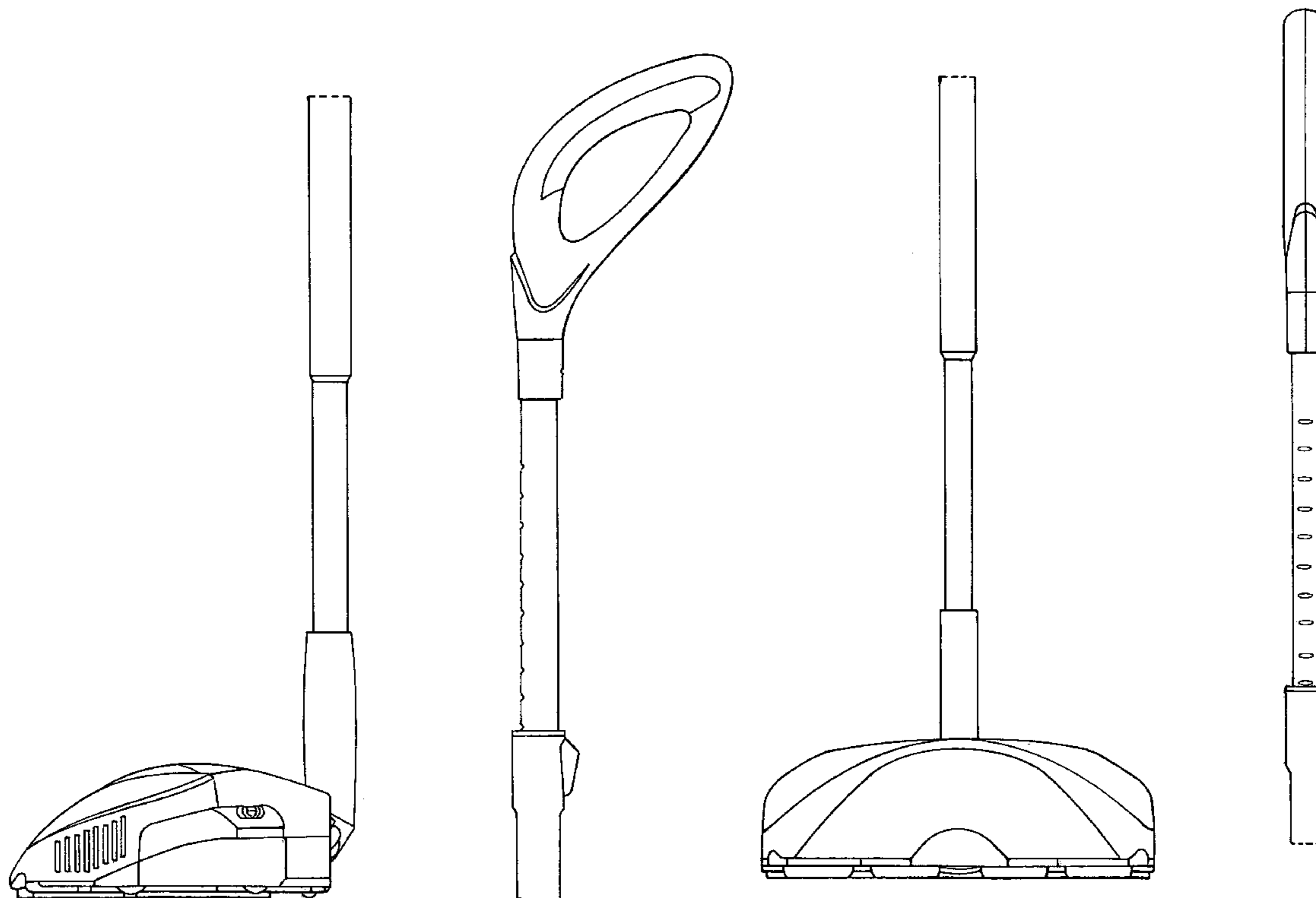

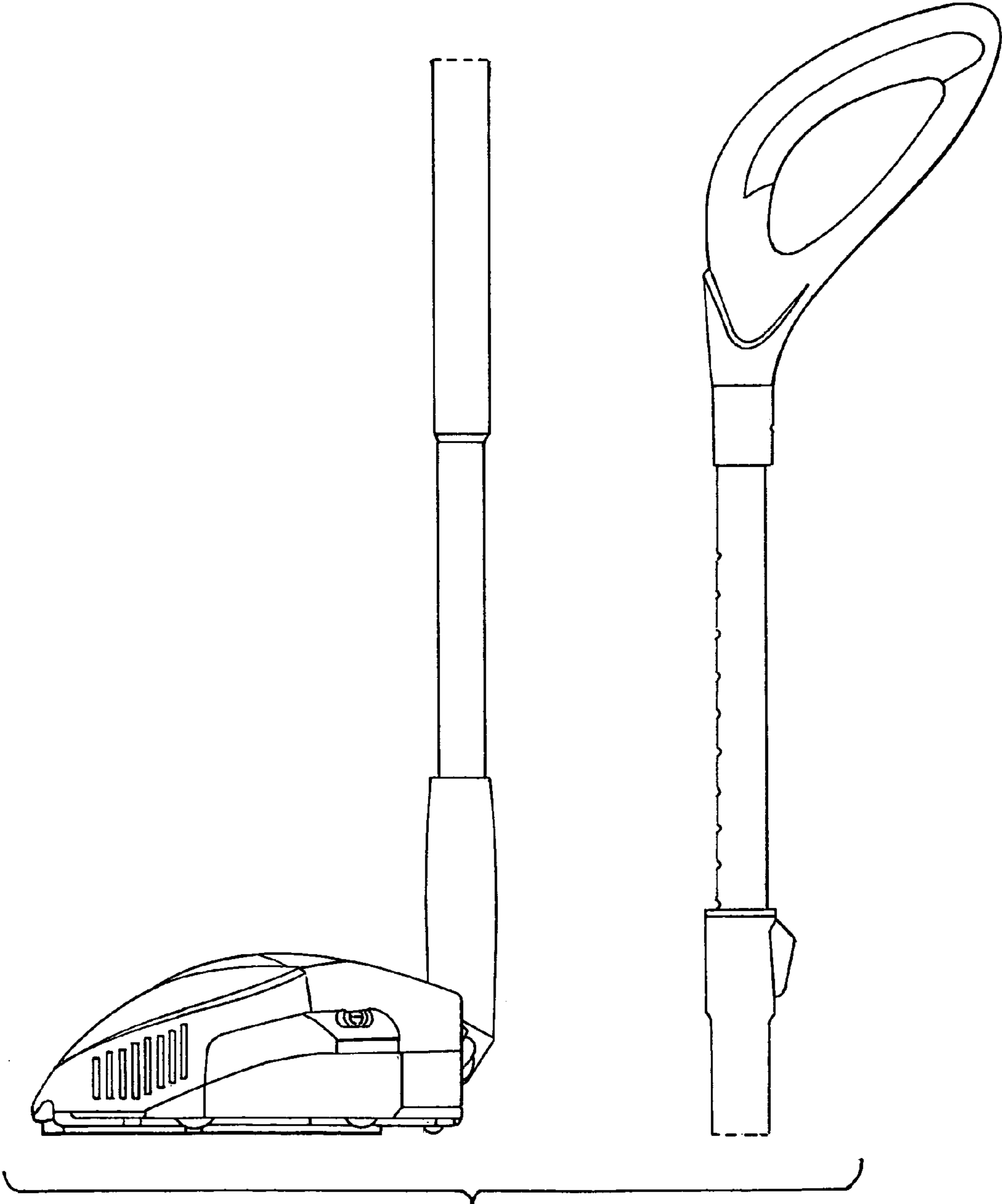
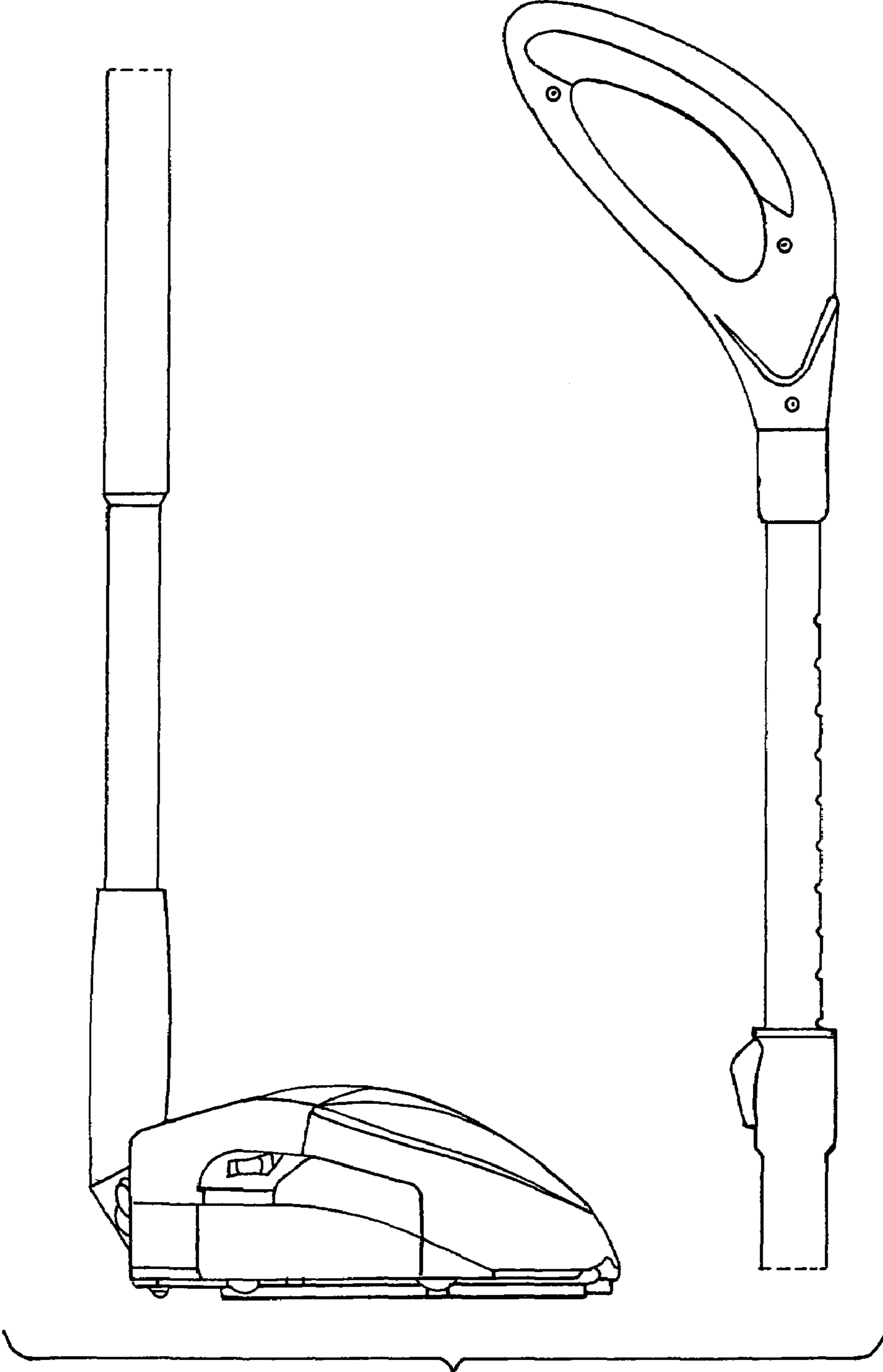

FIG. 1



*FIG. 2*

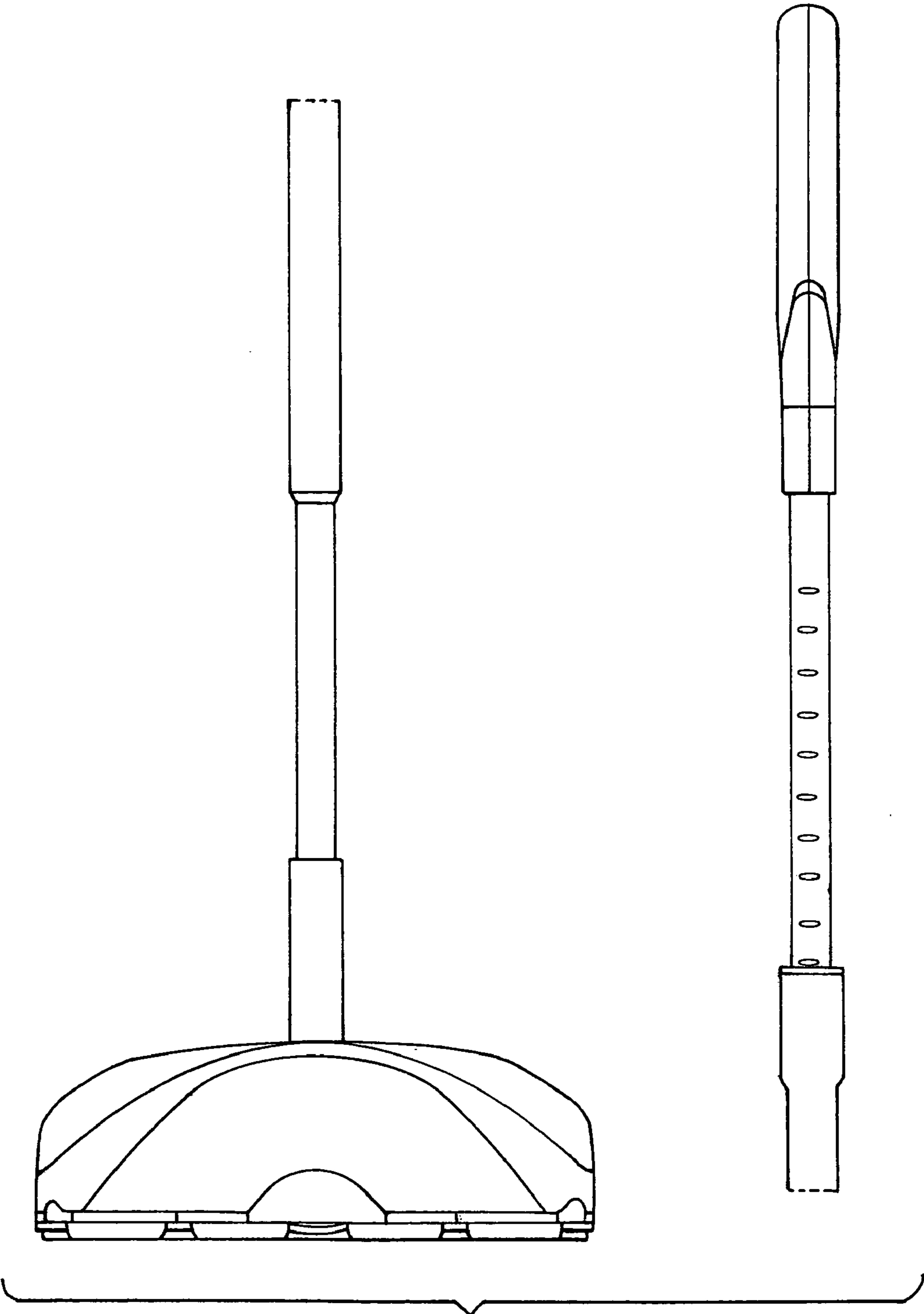

FIG. 3

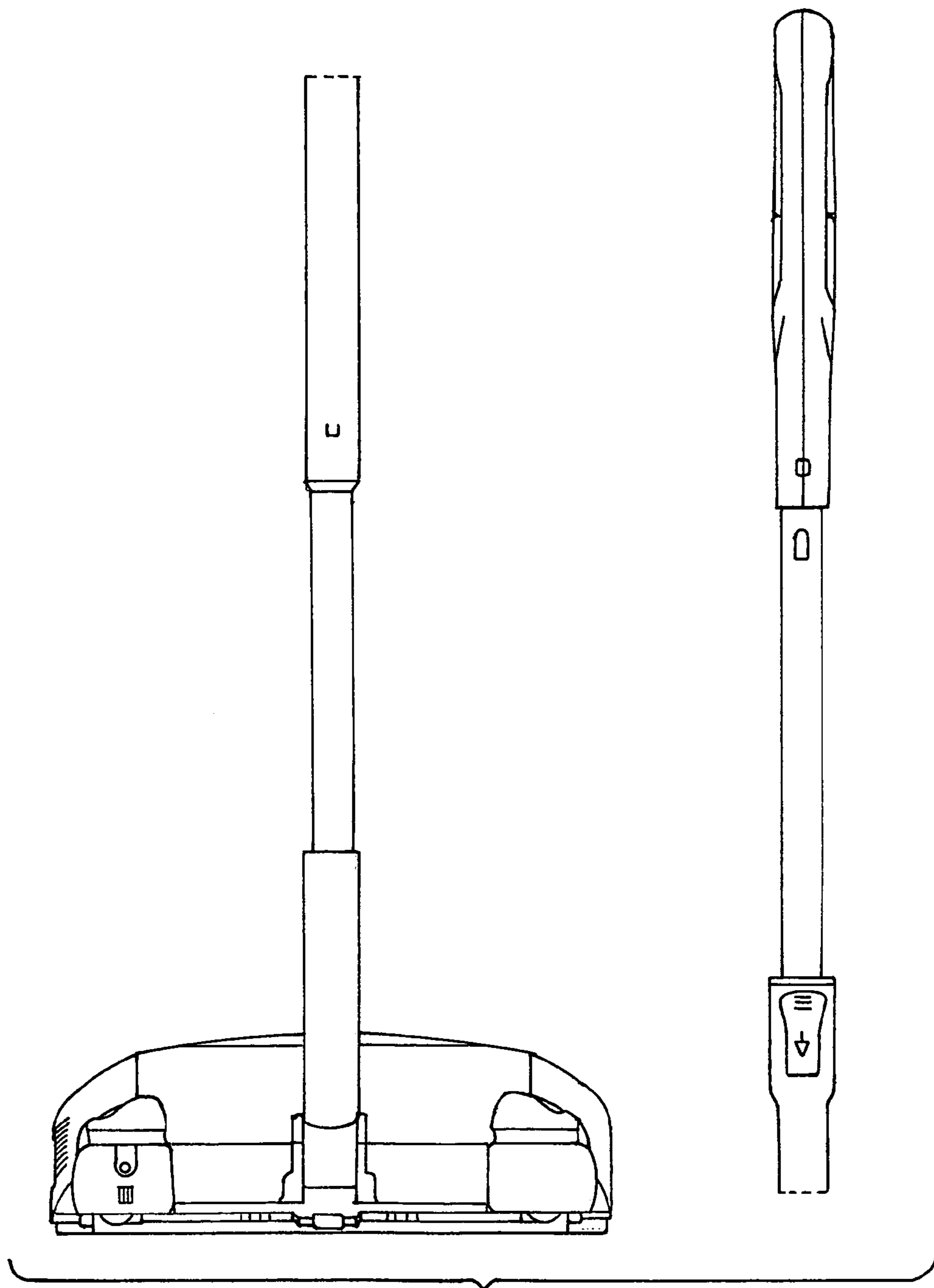
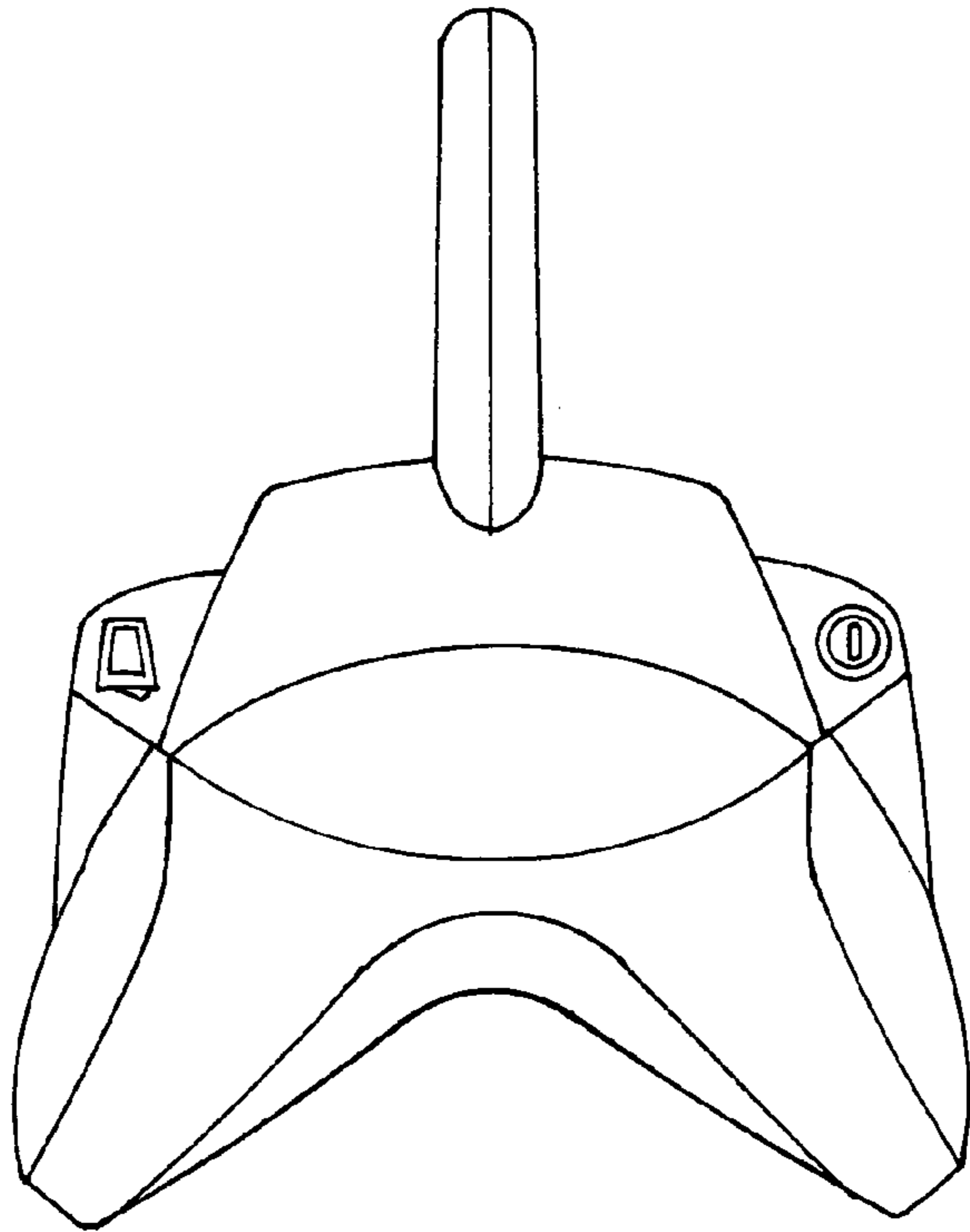
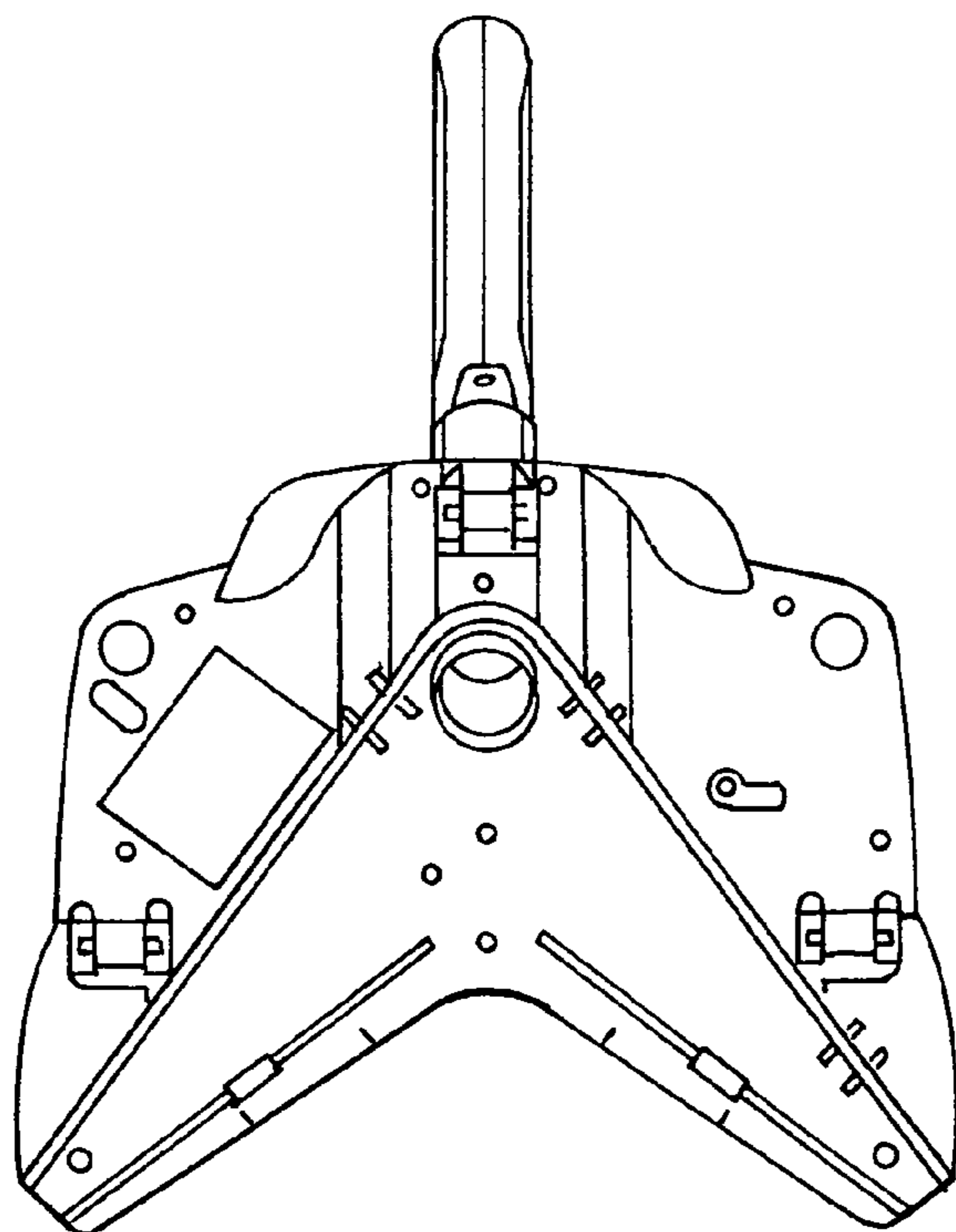

FIG. 4



*FIG. 5*



*FIG. 6*