



US00D591789S

(12) **United States Design Patent**
Li

(10) **Patent No.:** **US D591,789 S**

(45) **Date of Patent:** **** May 5, 2009**

(54) **EYEGLOSS FRAME**

(75) Inventor: **Jui-Chi Li**, Tainan (TW)

(73) Assignee: **Sun Sight Glasses Co., Ltd.**, Tainan (TW)

(**) Term: **14 Years**

(21) Appl. No.: **29/302,336**

(22) Filed: **Jan. 15, 2008**

(51) **LOC (9) Cl.** **16-06**

(52) **U.S. Cl.** **D16/326; D16/311**

(58) **Field of Classification Search** D16/101,
D16/300-342; D29/109-110; D24/110.2;
351/41, 44, 51-52, 62, 158, 92, 103-123,
351/140, 153; 2/426-432, 447-449, 441,
2/434-437; D21/483, 659-661

See application file for complete search history.

(56) **References Cited**

U.S. PATENT DOCUMENTS

D535,681 S *	1/2007	Yang	D16/311
D541,839 S *	5/2007	Sheldon	D16/326
D549,764 S *	8/2007	Teng	D16/326
D561,810 S *	2/2008	Fox et al.	D16/325
D570,899 S *	6/2008	Lee	D16/326

* cited by examiner

Primary Examiner—Raphael Barkai

(74) *Attorney, Agent, or Firm*—Alan Kamrath; Kamrath & Associates PA

(57) **CLAIM**

The ornamental design for eyeglass frame, as shown and described.

DESCRIPTION

FIG. 1 is a perspective view of an eyeglass frame showing my new design;

FIG. 2 is a front side elevational view thereof;

FIG. 3 is a rear side elevational view thereof;

FIG. 4 is a left side elevational view thereof;

FIG. 5 is a right side elevational view thereof;

FIG. 6 is a top plan view thereof;

FIG. 7 is a bottom plan view thereof;

FIG. 8 is a perspective view showing the eyeglass frame in condition of use with eyeglass temples, the broken line showing of eyeglass temples is for illustrative purposes only and forms no part of the claimed design; and,

FIG. 9 is a perspective view showing the eyeglass frame in condition of use with an eyeglass strap, the broken line showing of eyeglass strap is for illustrative purposes only and forms no part of the claimed design.

1 Claim, 4 Drawing Sheets

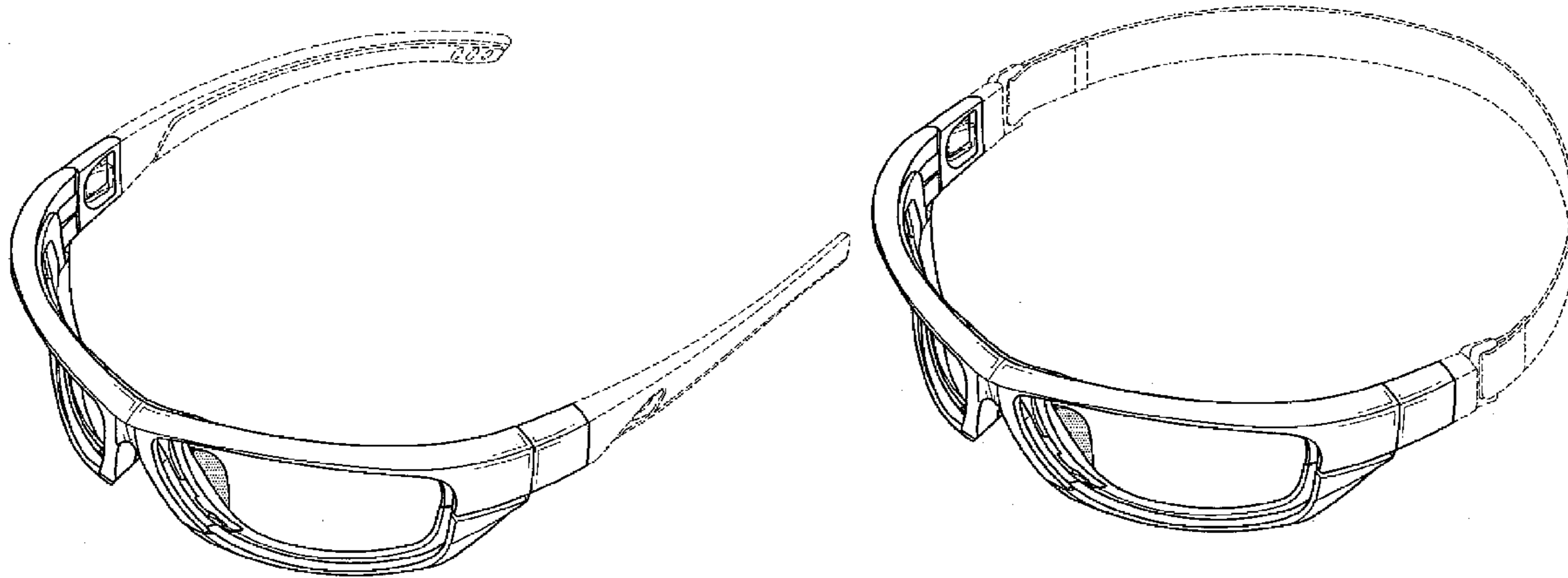

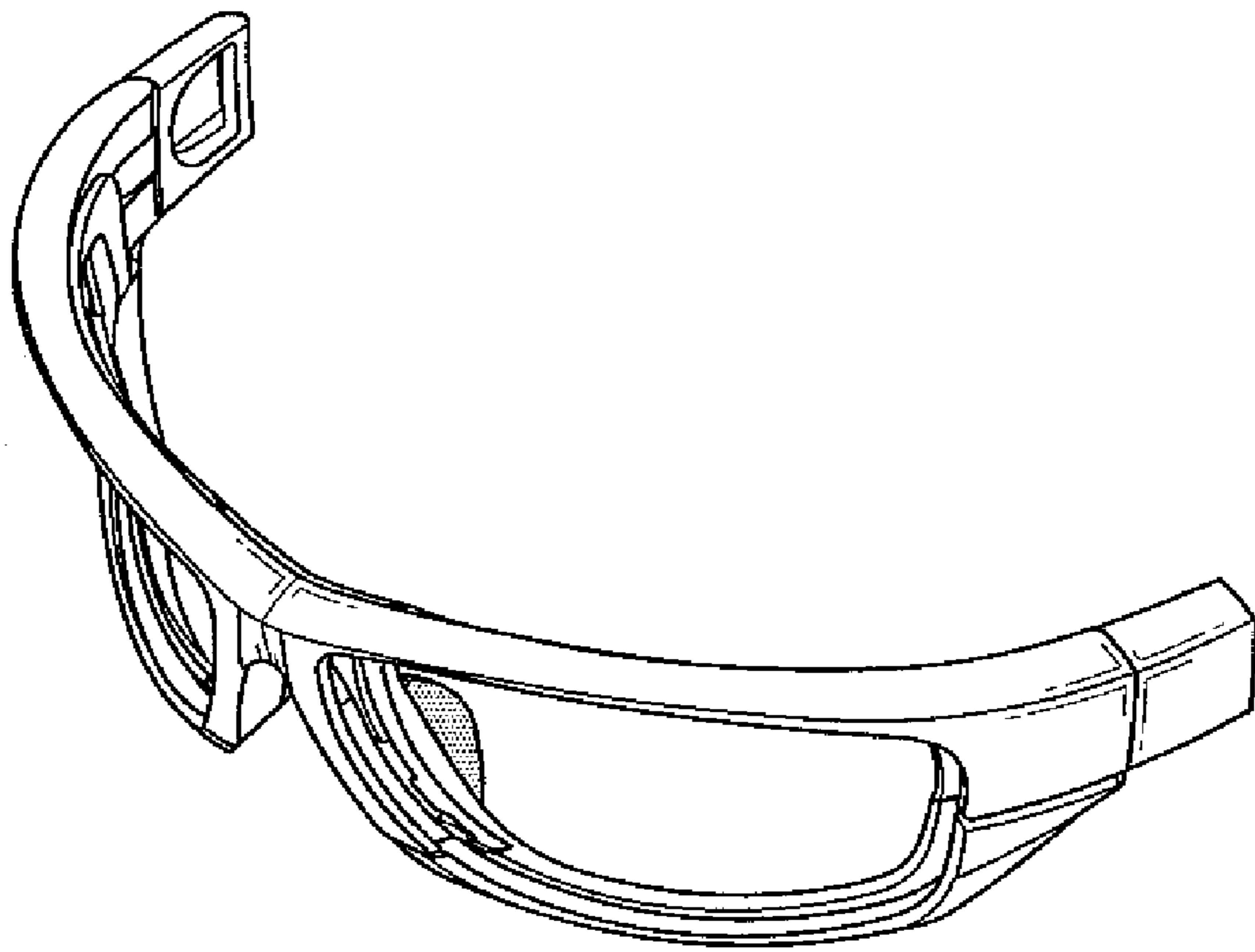

FIG. 1

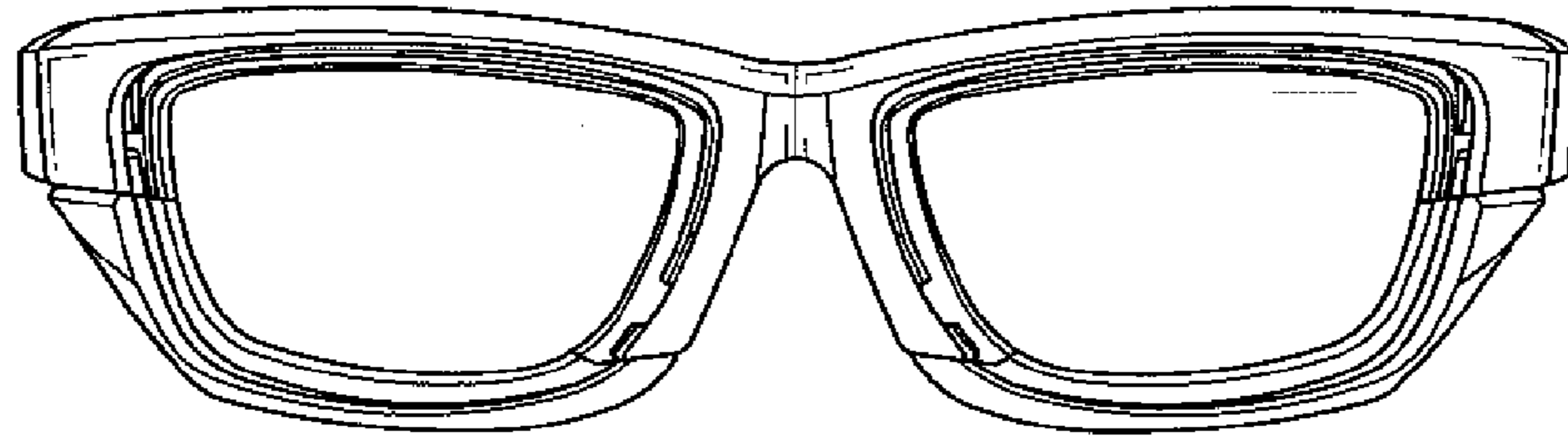

FIG. 2

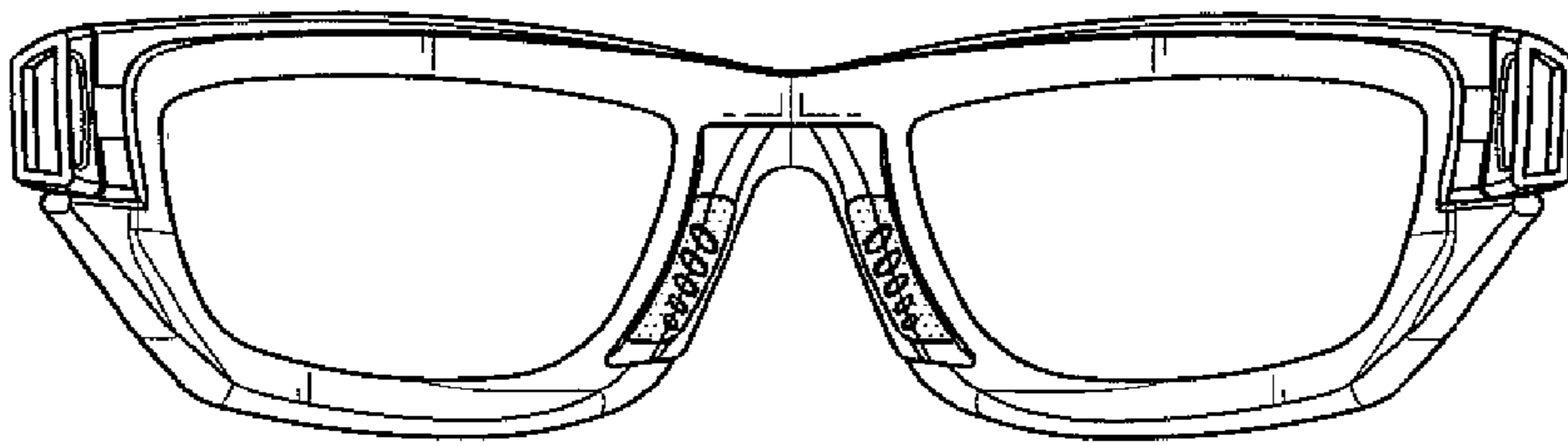

FIG. 3

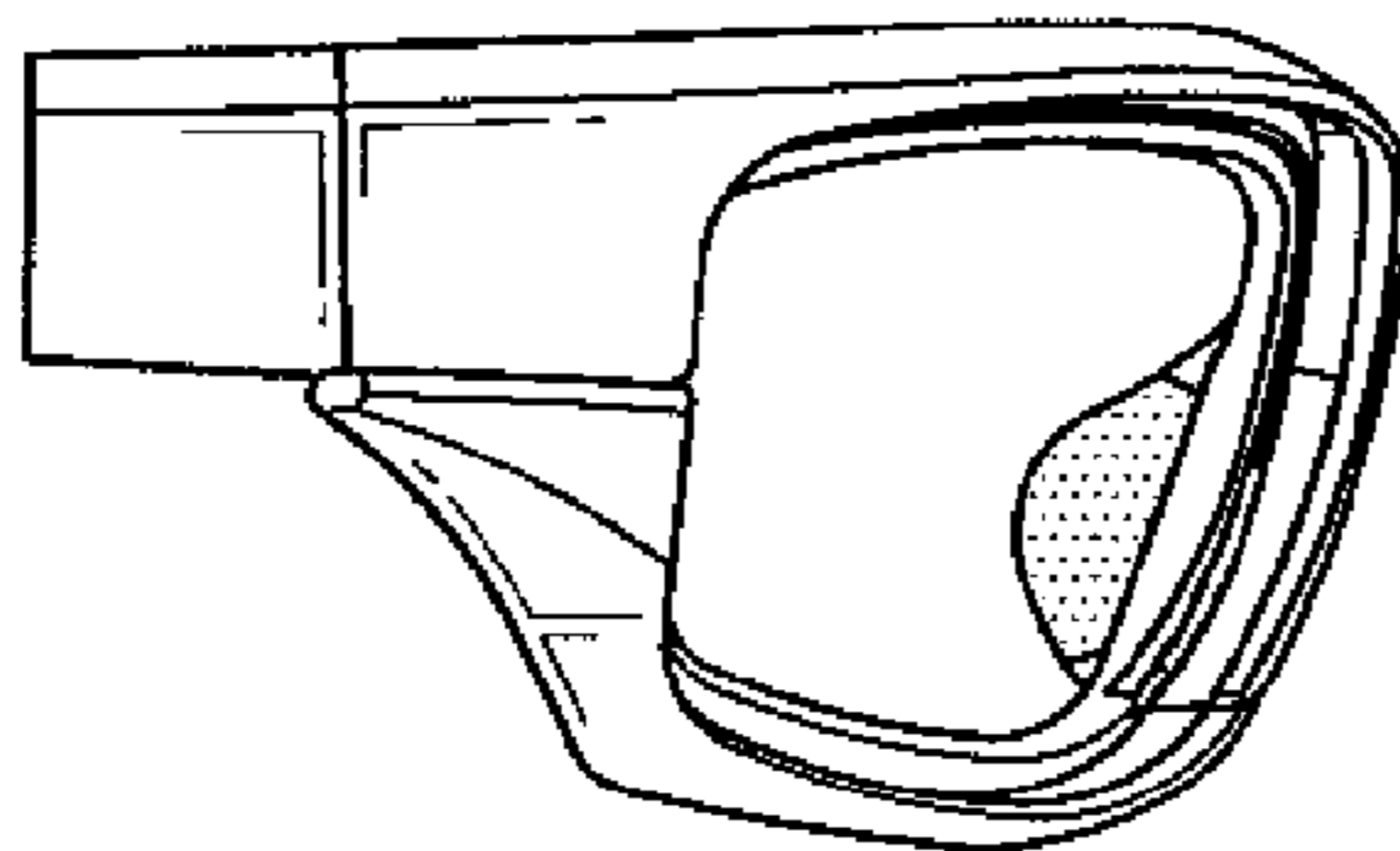

FIG. 4

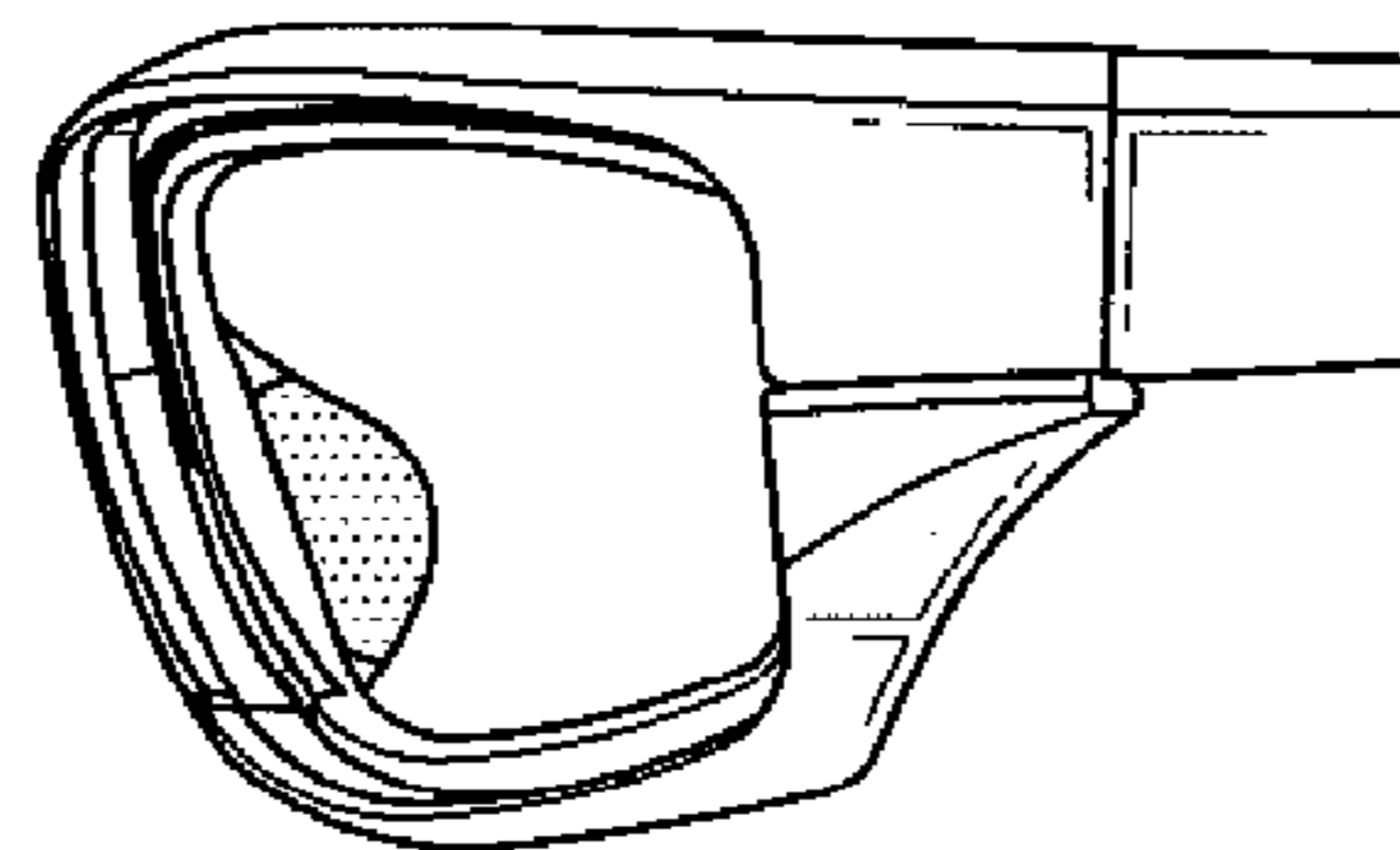

FIG. 5

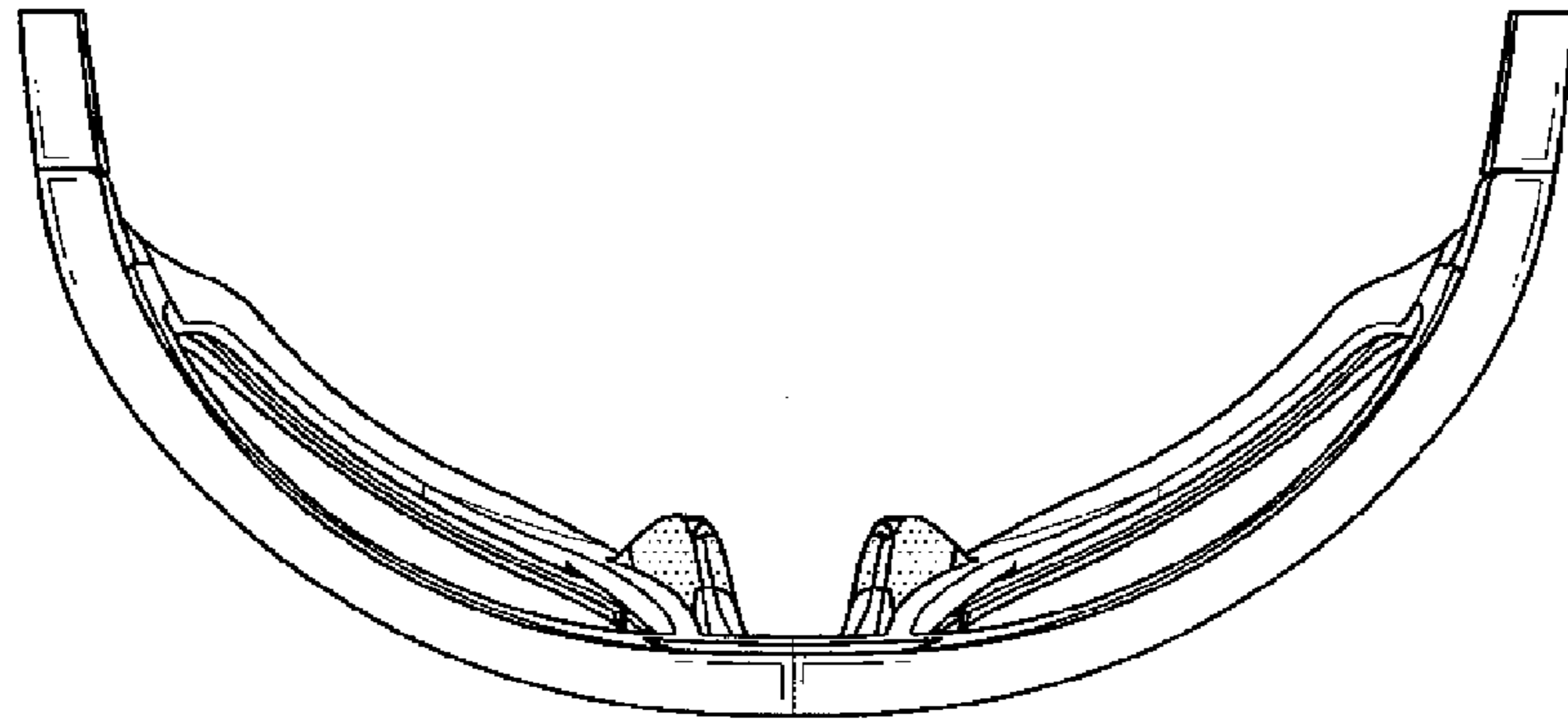

FIG. 6

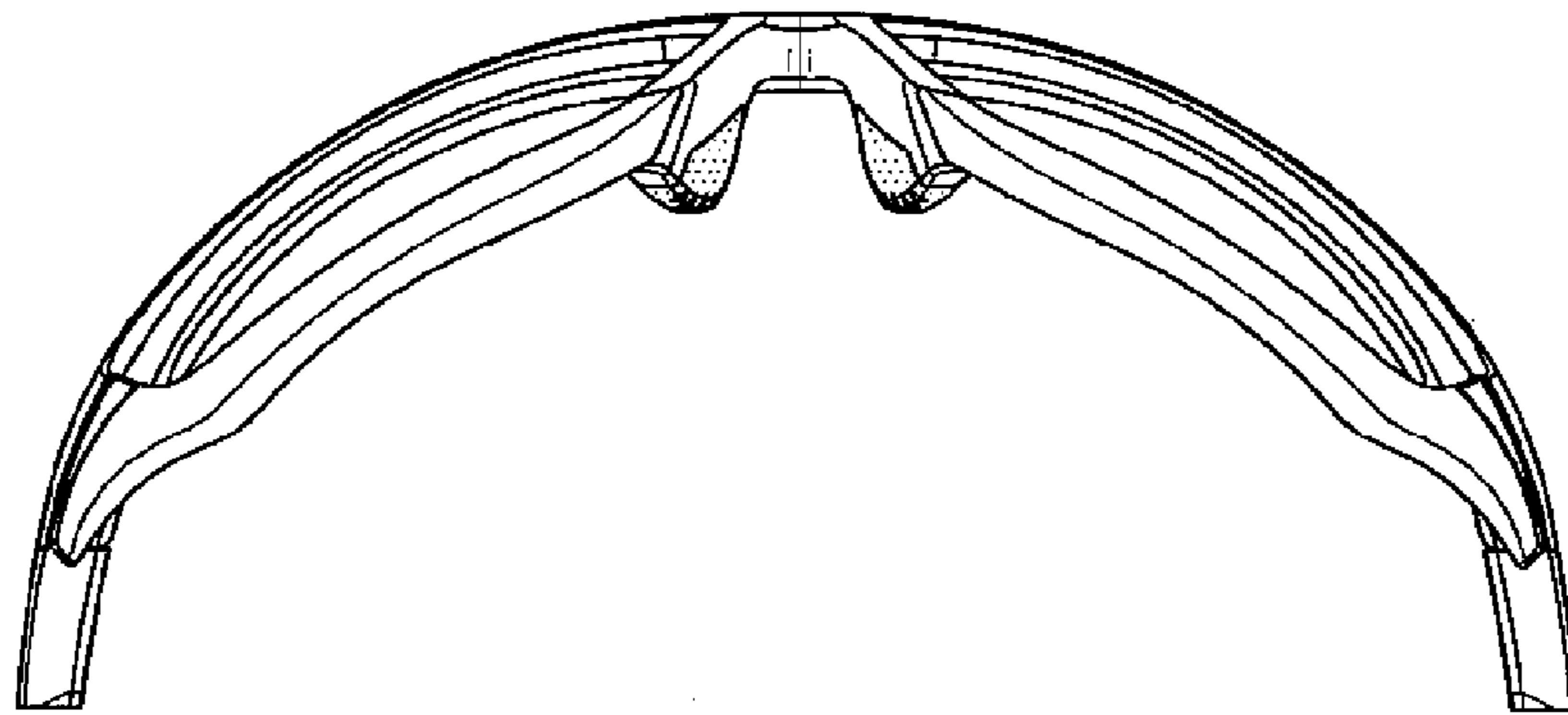

FIG. 7

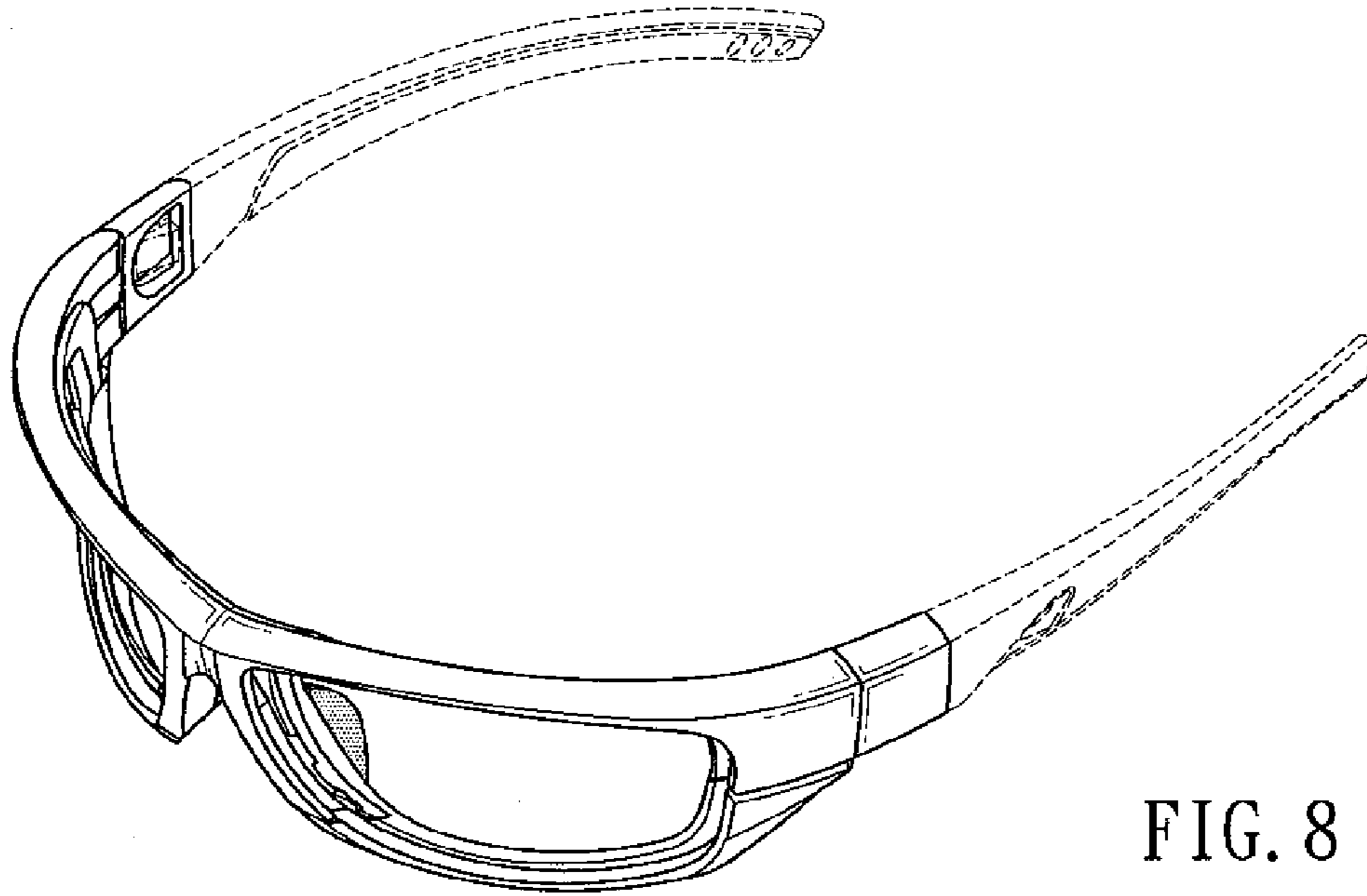

FIG. 8

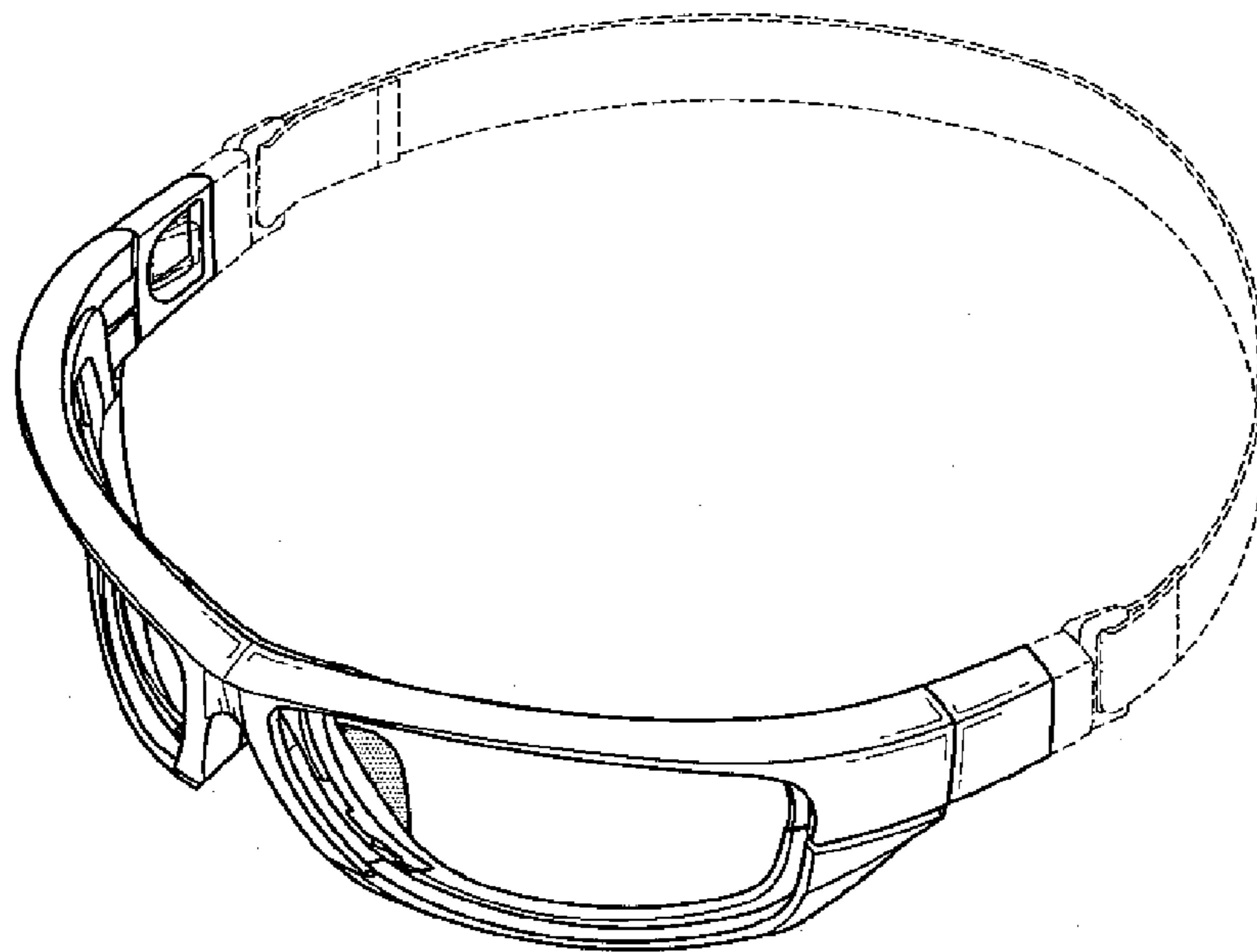

FIG. 9