



US00D591752S

(12) **United States Design Patent**
Aoki

(10) **Patent No.:** **US D591,752 S**

(45) **Date of Patent:** **** May 5, 2009**

(54) **MEMORY CARD**

(75) Inventor: **Yoshitaka Aoki**, Tokyo (JP)

(73) Assignee: **Sony Corporation**, Tokyo (JP)

(**) Term: **14 Years**

(21) Appl. No.: **29/300,960**

(22) Filed: **Jun. 5, 2008**

(30) **Foreign Application Priority Data**

Dec. 6, 2007	(JP)	D2007-033446
Dec. 6, 2007	(JP)	D2007-033447
Jun. 2, 2008	(JP)	D2008-013917
Jun. 2, 2008	(JP)	D2008-013918

(51) **LOC (9) Cl.** **14-02**

(52) **U.S. Cl.** **D14/436**

(58) **Field of Classification Search** D14/435-438,
D14/478-483, 474, 475, 335, 496, 125, 188,
D14/192, 204, 217, 265, 433, 432, 242; 235/441,
235/443, 487, 492, 493, 495, 486, 451, 479,
235/453; 361/737, 679, 752, 736, 728, 796,
361/797, 729, 730, 725-727, 740, 747, 759,
361/801, 816, 738, 766, 799, 807, 829; 257/678,
257/679, 693, E23.064; 439/946, 948, 159,
439/628, 638, 630, 267, 260, 945, 95, 140,
439/101, 67, 76.1, 108, 147, 148; 174/250,
174/260, 52.1, 52.2, 35 R, 51; 710/300-303,
710/62, 74; 438/121; D21/332, 333; 455/344-351;
369/1, 4, 6-12; 381/119, 120; 700/94; 345/156,
345/184; 312/233.2; 206/706, 701; 360/129,
360/132, 133, 135; D13/182

See application file for complete search history.

(56) **References Cited**

U.S. PATENT DOCUMENTS

D248,470 S * 7/1978 Talesfore D14/435

(Continued)

Primary Examiner—Susan Moon Lee

(74) *Attorney, Agent, or Firm*—Rader, Fishman & Grauer,
PLLC

(57) **CLAIM**

The ornamental design for a memory card, as shown.

DESCRIPTION

FIG. 1 is a perspective view of a first embodiment of a memory card showing my new design;

FIG. 2 is a front elevational view thereof;

FIG. 3 is a rear elevational view thereof;

FIG. 4 is a left side elevational view thereof;

FIG. 5 is a right side elevational view thereof;

FIG. 6 is a top plan view thereof; and

FIG. 7 is a bottom plan view thereof.

FIG. 8 is a perspective view of a second embodiment of a memory card showing my new design;

FIG. 9 is a front elevational view thereof;

FIG. 10 is a rear elevational view thereof;

FIG. 11 is a left side elevational view thereof;

FIG. 12 is a right side elevational view thereof;

FIG. 13 is a top plan view thereof; and

FIG. 14 is a bottom plan view thereof.

FIG. 15 is a perspective view of a third embodiment of a memory card showing my new design;

FIG. 16 is a front elevational view thereof;

FIG. 17 is a rear elevational view thereof;

FIG. 18 is a left side elevational view thereof;

FIG. 19 is a right side elevational view thereof;

FIG. 20 is a top plan view thereof; and

FIG. 21 is a bottom plan view thereof.

FIG. 22 is a perspective view of a fourth embodiment of a memory card showing my new design;

FIG. 23 is a front elevational view thereof;

FIG. 24 is a rear elevational view thereof;

FIG. 25 is a left side elevational view thereof;

FIG. 26 is a right side elevational view thereof;

FIG. 27 is a top plan view thereof; and

FIG. 28 is a bottom plan view thereof.

1 Claim, 28 Drawing Sheets

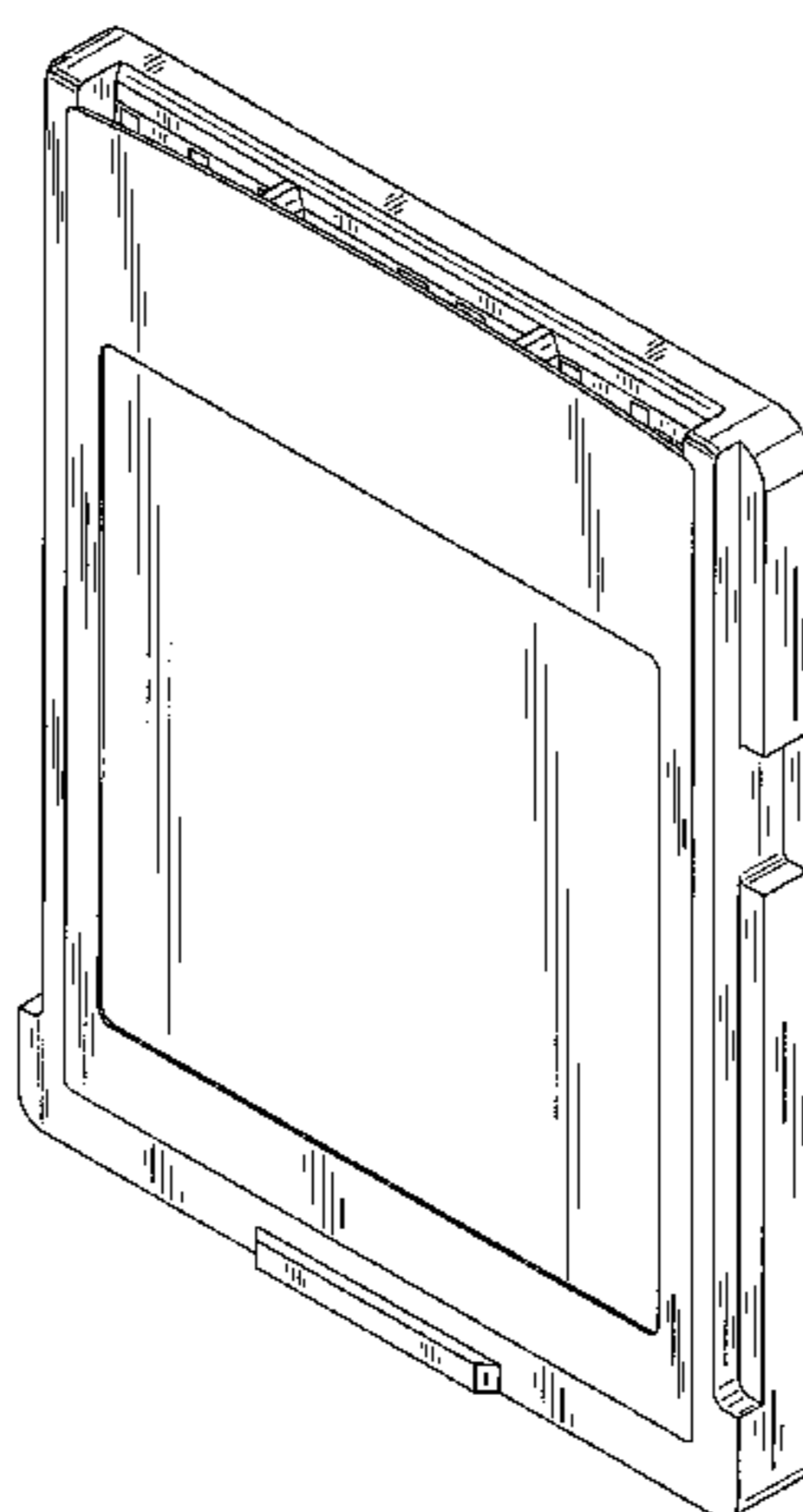

US D591,752 S

Page 2

U.S. PATENT DOCUMENTS

D257,345 S *	10/1980	Levy	D14/435	D432,505 S	10/2000	Oba et al.	
D290,705 S *	7/1987	Yomo	D14/435	6,139,338 A *	10/2000	Hirai et al.	439/141
D299,475 S *	1/1989	Munnik	D19/78	6,144,563 A *	11/2000	Feldman et al.	361/829
D302,427 S *	7/1989	Pushelberg	D14/435	6,151,219 A *	11/2000	Dye	361/737
D321,429 S *	11/1991	Kojo	D6/634	6,217,351 B1 *	4/2001	Fung et al.	439/131
5,242,310 A *	9/1993	Leung	439/76.1	6,295,031 B1 *	9/2001	Wallace et al.	343/702
D350,115 S *	8/1994	Iftikar et al.	D14/479	6,313,400 B1 *	11/2001	Mosquera et al.	174/363
5,361,061 A *	11/1994	Mays et al.	340/7.54	D451,501 S *	12/2001	Sward et al.	D14/242
5,374,198 A *	12/1994	Nagata	439/157	6,330,163 B1 *	12/2001	Bates et al.	361/737
5,488,523 A *	1/1996	Seaver et al.	360/99.12	6,348,893 B1 *	2/2002	Herranen et al.	343/702
5,490,791 A *	2/1996	Yamada et al.	439/159	6,365,832 B1 *	4/2002	Staron et al.	174/541
D368,082 S *	3/1996	Goto	D14/435	D457,887 S	5/2002	Kadonaga	
5,502,620 A *	3/1996	Funck et al.	361/753	6,399,906 B1 *	6/2002	Sato et al.	200/61.59
5,544,007 A *	8/1996	Inoue	361/684	D466,119 S	11/2002	Funahashi et al.	
5,546,278 A *	8/1996	Bethurum	361/737	6,518,927 B2 *	2/2003	Schremmer et al.	343/702
5,548,483 A *	8/1996	Feldman	361/737	6,527,188 B1 *	3/2003	Shobara et al.	235/486
5,563,771 A *	10/1996	Bethurum	361/737	6,540,560 B1 *	4/2003	Ito et al.	439/633
D382,868 S *	8/1997	Ashida	D14/435	D476,012 S *	6/2003	Taniguchi et al.	D14/436
5,653,596 A *	8/1997	Banakis et al.	439/64	6,628,524 B1 *	9/2003	Washino et al.	361/737
5,673,181 A *	9/1997	Hsu	361/760	6,632,097 B2 *	10/2003	Chang	439/76.1
5,681,002 A *	10/1997	Kikuchi	242/347	6,655,972 B2 *	12/2003	Sato	439/159
D386,475 S *	11/1997	Hiramatsu	D13/182	6,669,095 B2 *	12/2003	Kiryu et al.	235/487
5,716,221 A *	2/1998	Kantner	439/64	6,699,053 B2 *	3/2004	Kuroda	439/218
5,726,867 A *	3/1998	Zarrei	361/818	6,751,694 B2 *	6/2004	Liu et al.	710/301
5,739,500 A *	4/1998	Van Beers	219/117.1	D492,687 S *	7/2004	Yu et al.	D14/436
D394,050 S	5/1998	Funawatari		6,783,399 B2 *	8/2004	Joung	439/630
5,747,735 A *	5/1998	Chang et al.	174/51	D505,133 S *	5/2005	Ashida et al.	D14/435
5,757,622 A *	5/1998	Tanaka et al.	361/737	6,928,302 B1 *	8/2005	Kinney et al.	455/558
5,768,110 A *	6/1998	Frommer et al.	361/755	6,939,182 B1 *	9/2005	Wen et al.	439/678
RE35,873 E *	8/1998	Simmons et al.	361/818	7,033,221 B2 *	4/2006	Bricaud et al.	439/630
5,833,473 A *	11/1998	Betker et al.	439/76.1	D522,068 S *	5/2006	Man-tat	D21/332
5,839,907 A *	11/1998	Kuo	439/76.1	D530,341 S *	10/2006	Maruyama et al.	D14/496
5,861,602 A *	1/1999	Cox et al.	219/121.64	7,153,165 B2 *	12/2006	Lai et al.	439/630
5,868,338 A *	2/1999	Martin et al.	242/348	D556,202 S	11/2007	Kadonaga	
5,879,170 A *	3/1999	Nogami	439/76.1	D563,430 S	3/2008	Deguchi et al.	
5,886,402 A *	3/1999	Onoda et al.	257/679	D563,995 S	3/2008	Deguchi et al.	
5,940,275 A *	8/1999	Laity	361/737	7,438,598 B1 *	10/2008	Ito et al.	439/630
5,994,769 A *	11/1999	Onoda et al.	257/679	7,458,519 B2 *	12/2008	Aoki et al.	235/492
6,008,994 A *	12/1999	Bates	361/737	2001/0043160 A1 *	11/2001	Hirai et al.	343/702
D418,692 S	1/2000	Funawatari		2003/0075609 A1 *	4/2003	Kim	235/492
6,031,278 A *	2/2000	Onoda et al.	257/679	2004/0110423 A1 *	6/2004	Shishikura et al.	439/630
D421,597 S	3/2000	Oba et al.		2005/0020137 A1 *	1/2005	Tanaka et al.	439/630
D425,072 S *	5/2000	Dosch et al.	D14/242	2005/0021909 A1 *	1/2005	Much et al.	711/115
6,106,309 A *	8/2000	Kakinoki	439/92				

* cited by examiner

FIG. 1

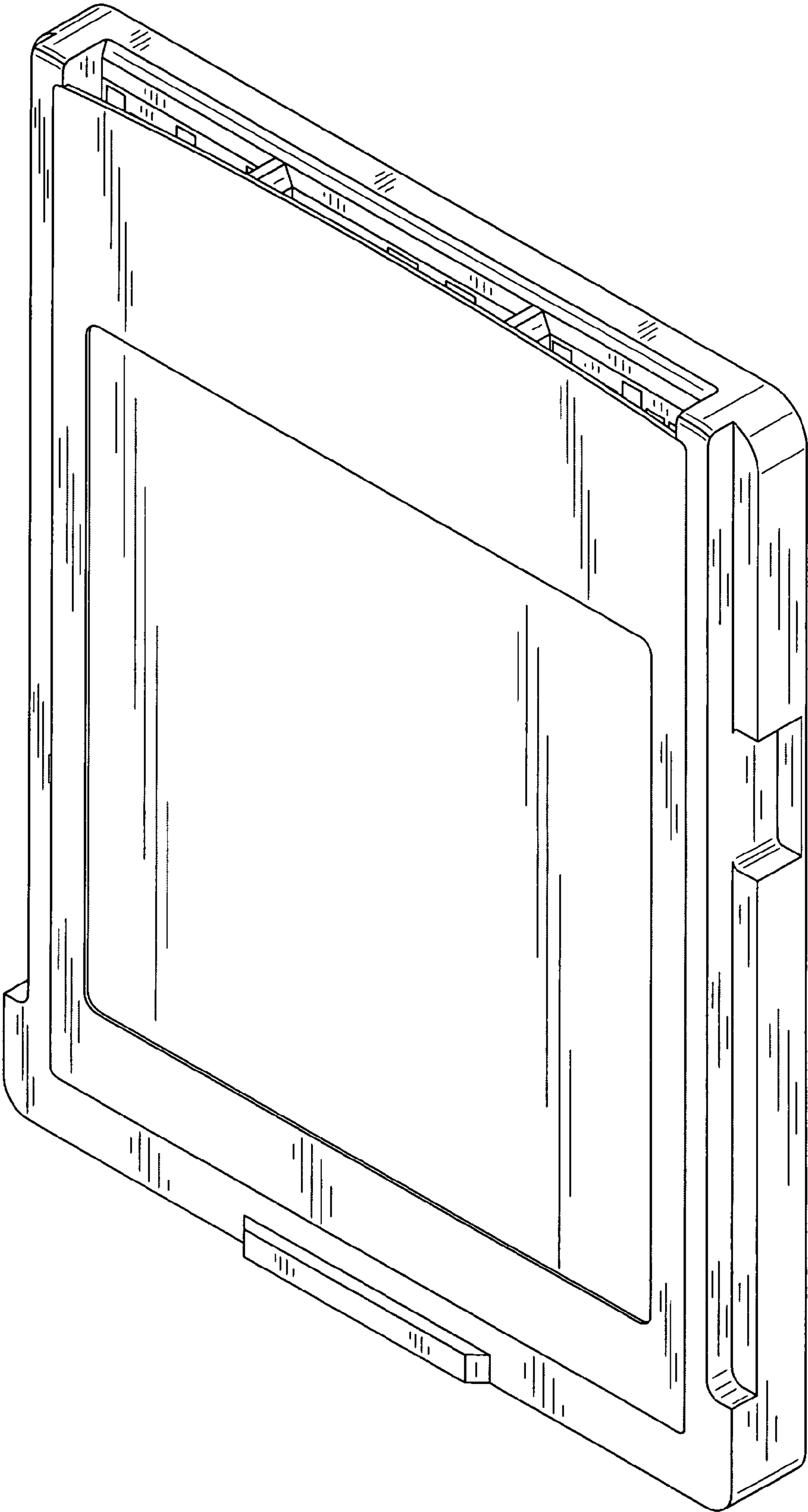

FIG.2

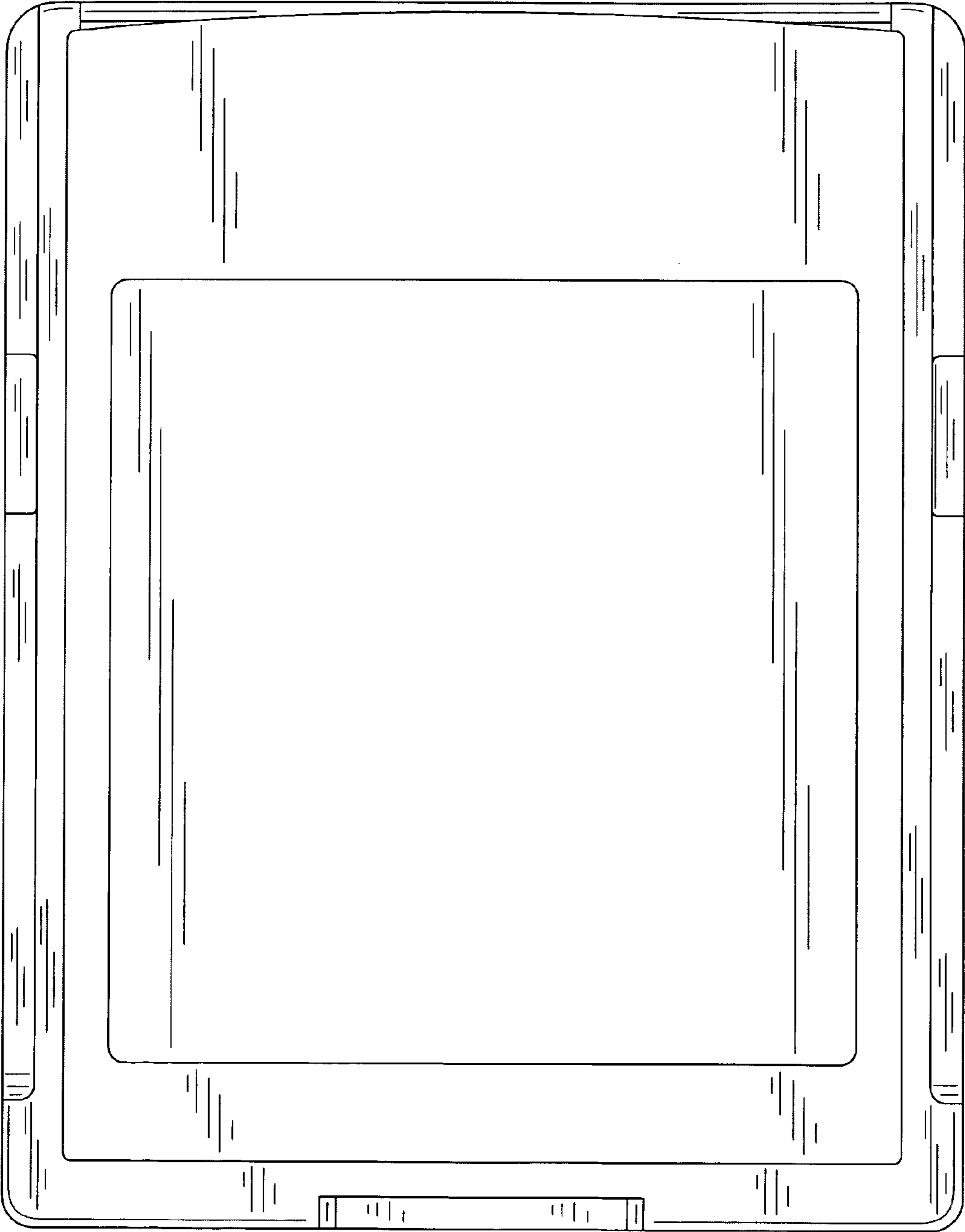

FIG.3

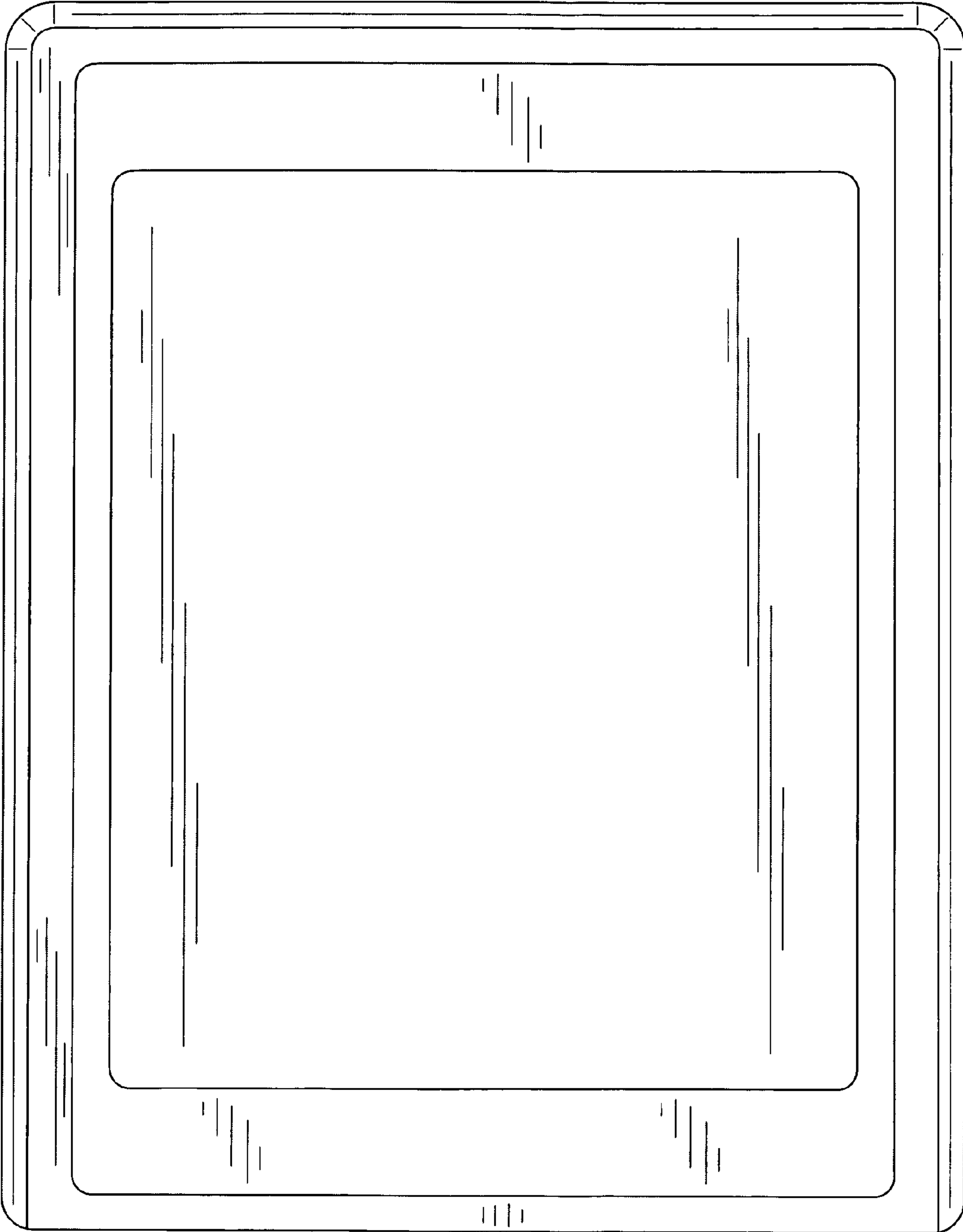

FIG.4

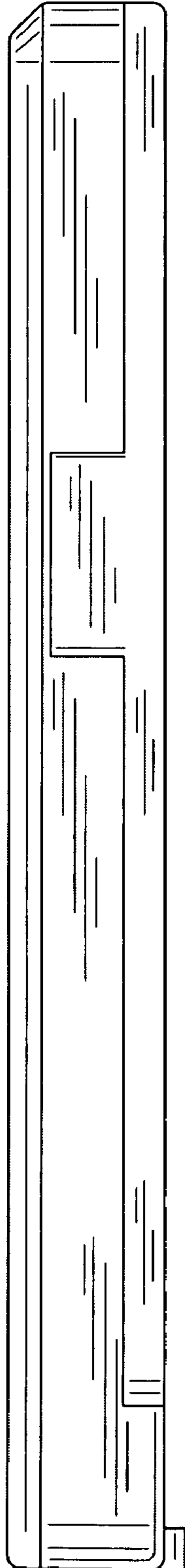

FIG.5

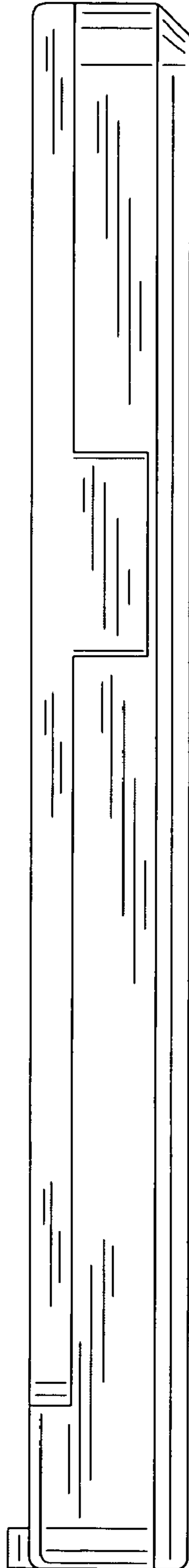

FIG.6

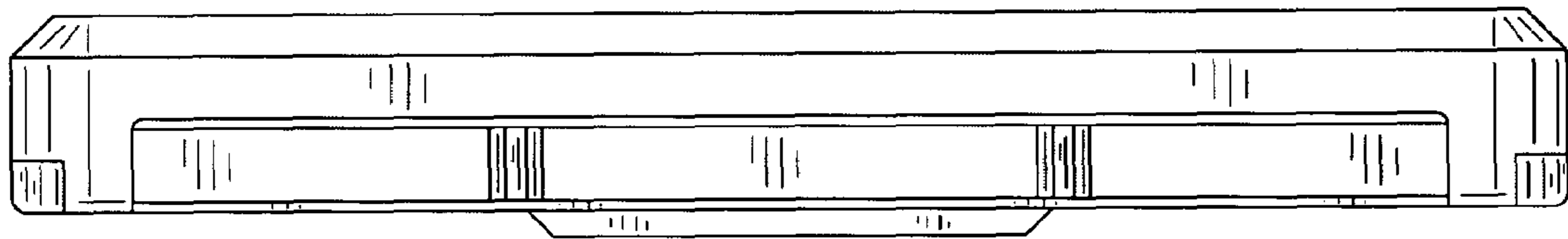

FIG.7

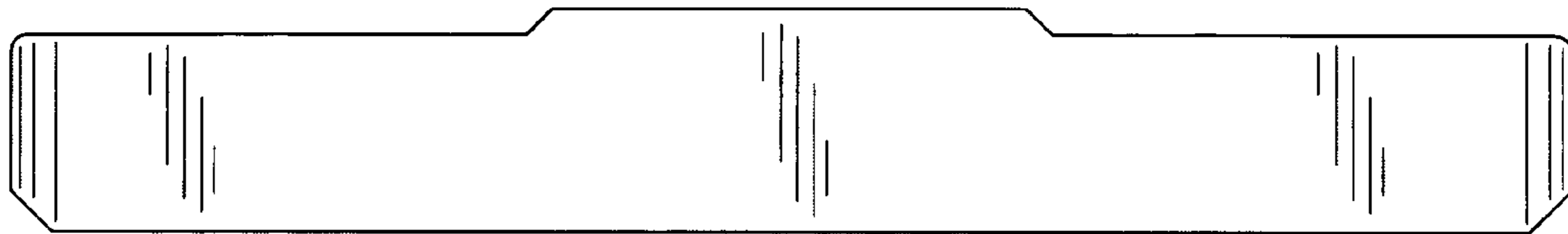

FIG.8

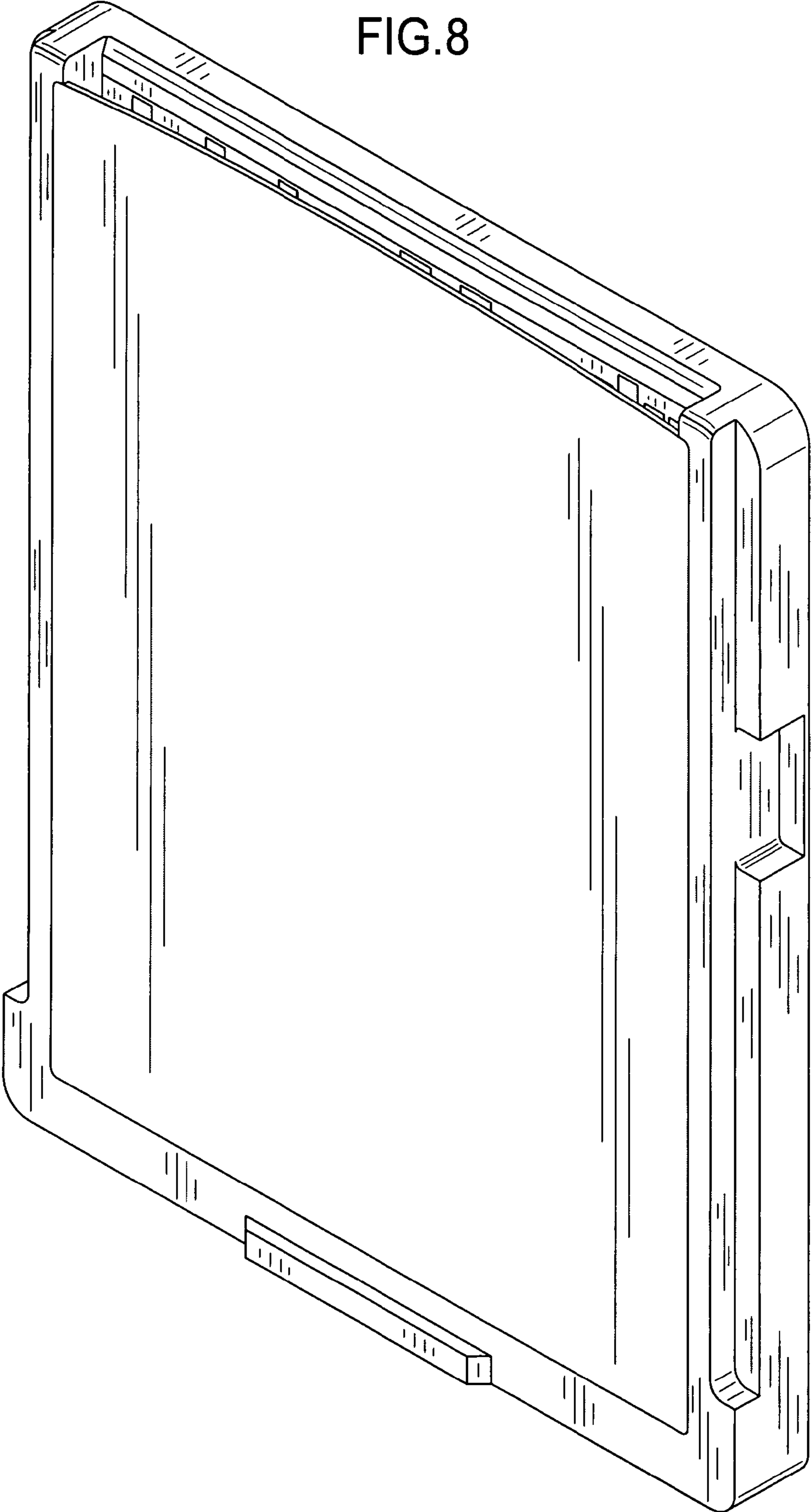

FIG.9

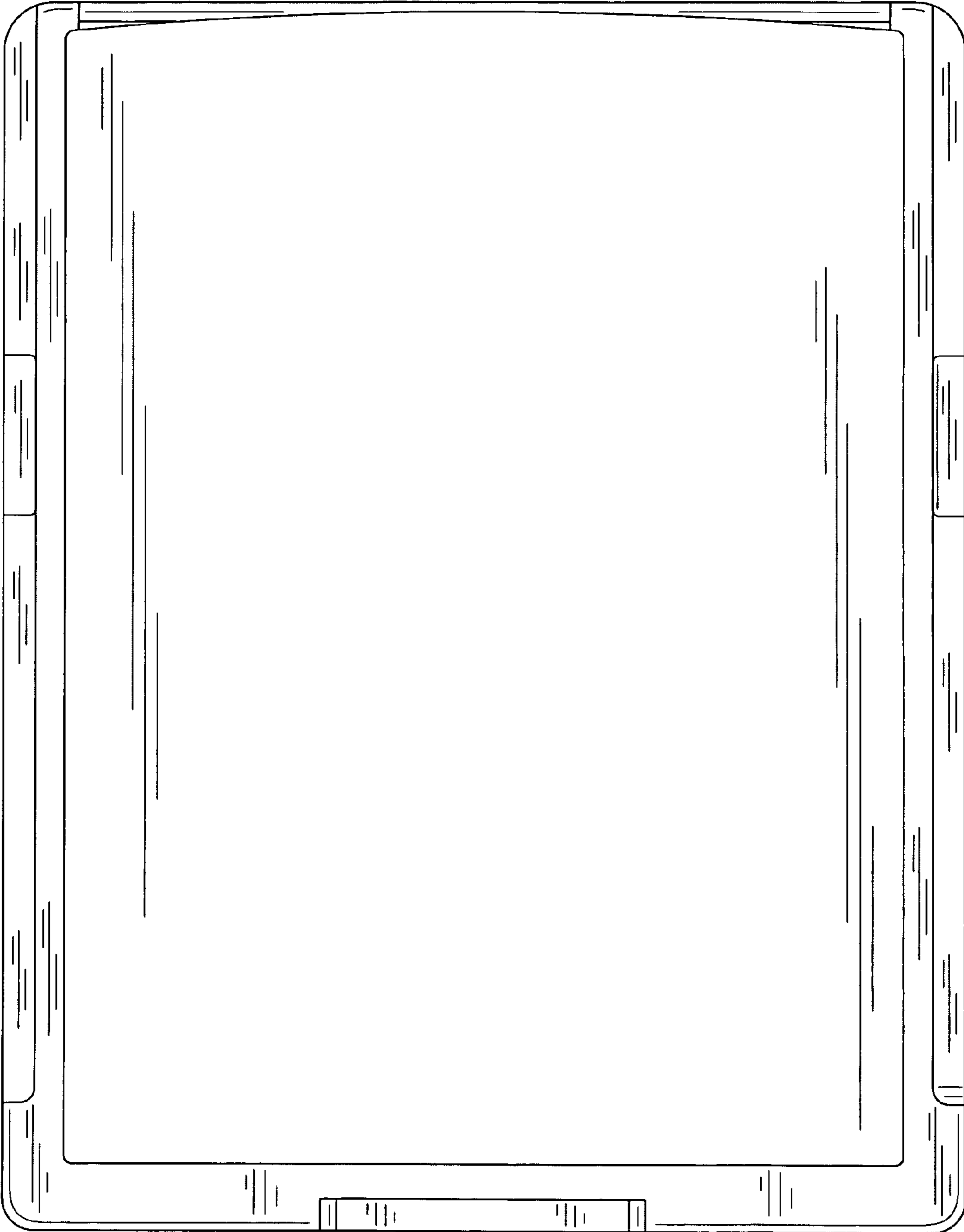

FIG.10

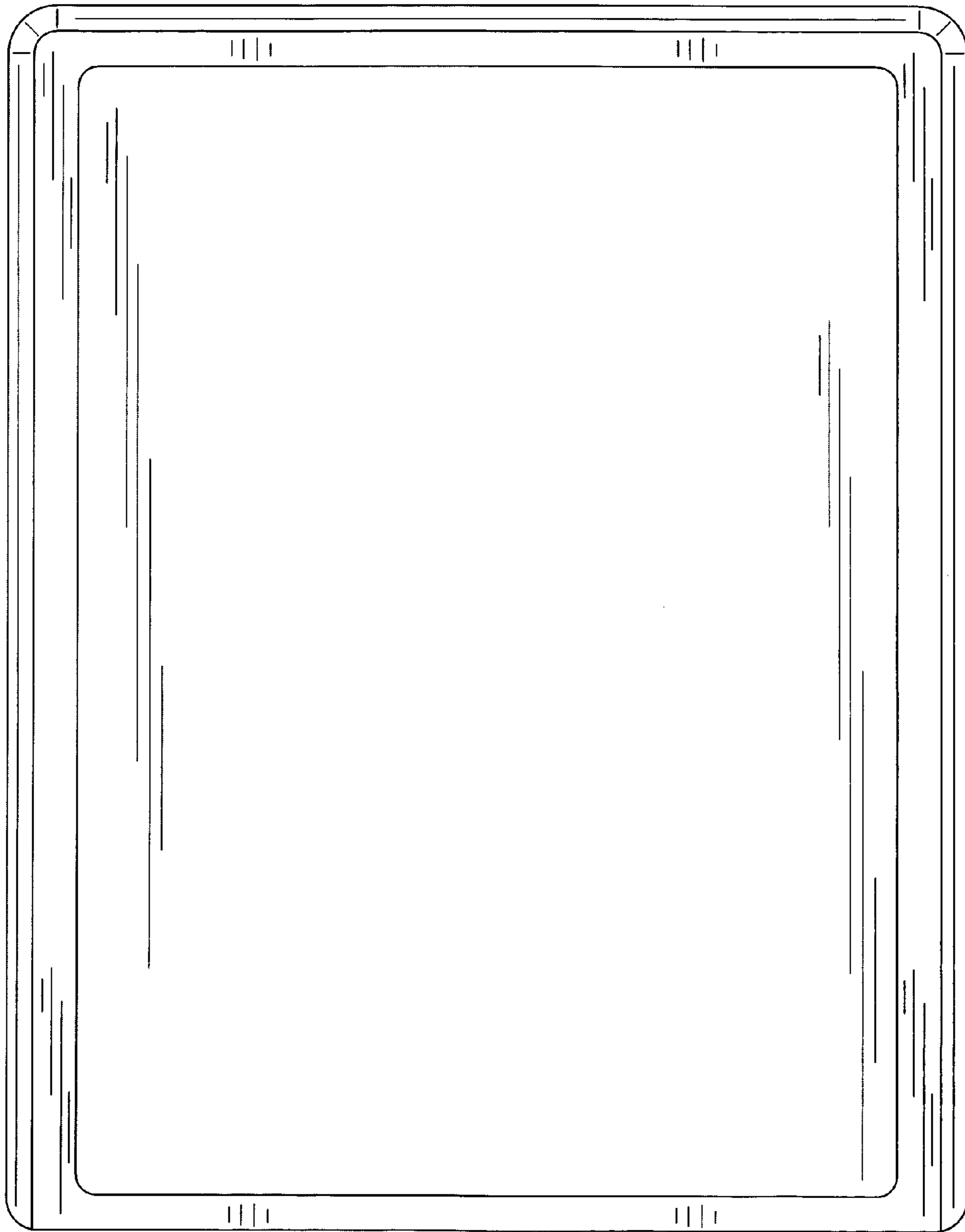

FIG. 11

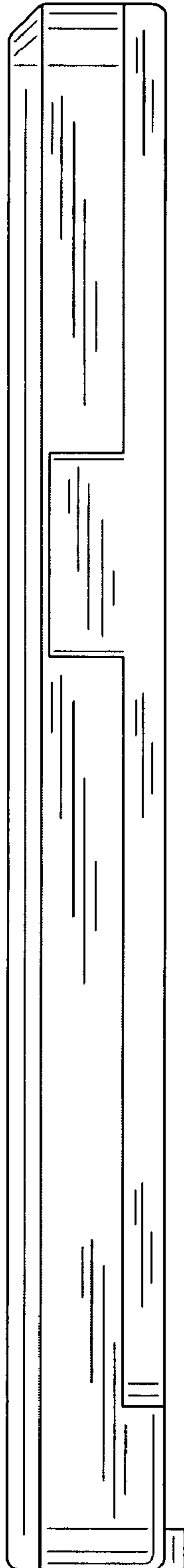

FIG.12

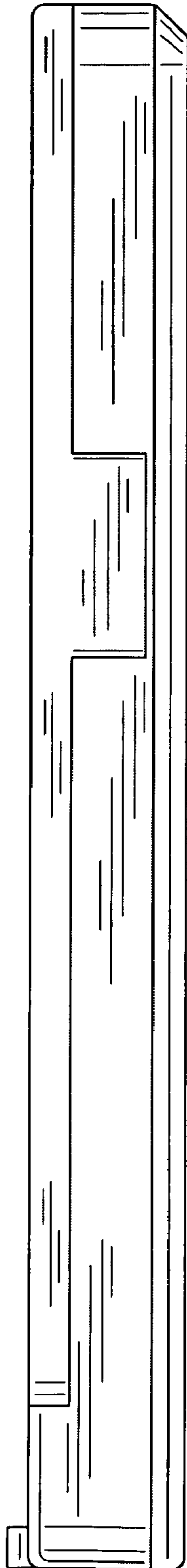

FIG.13

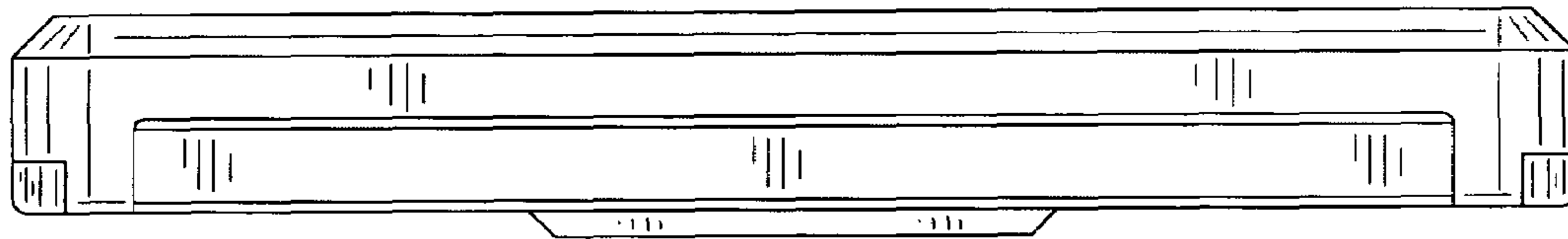

FIG.14

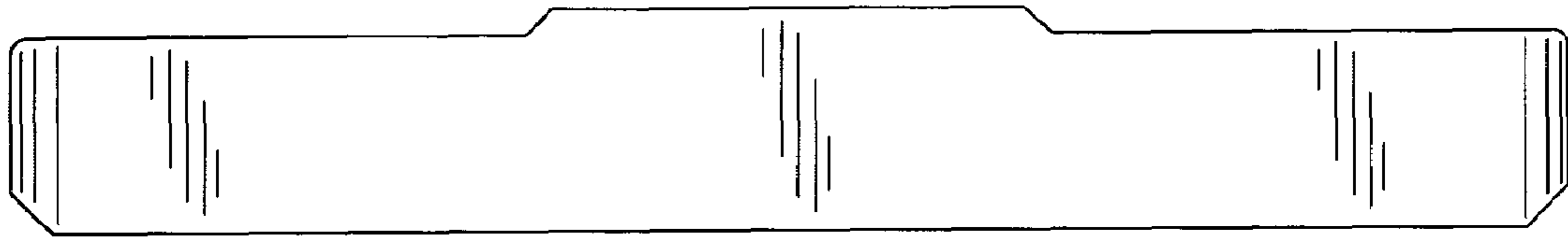

FIG.15

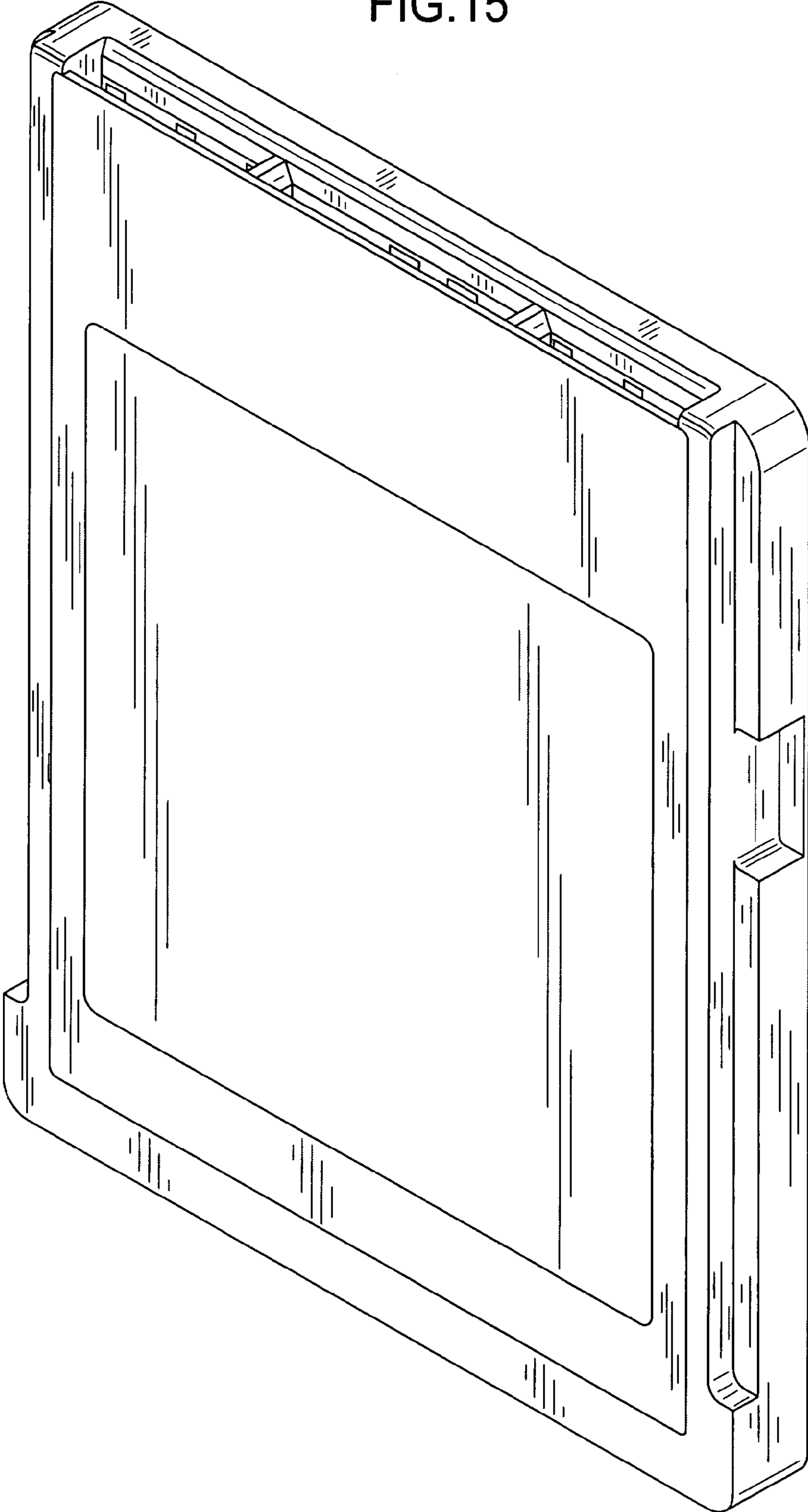

FIG.16

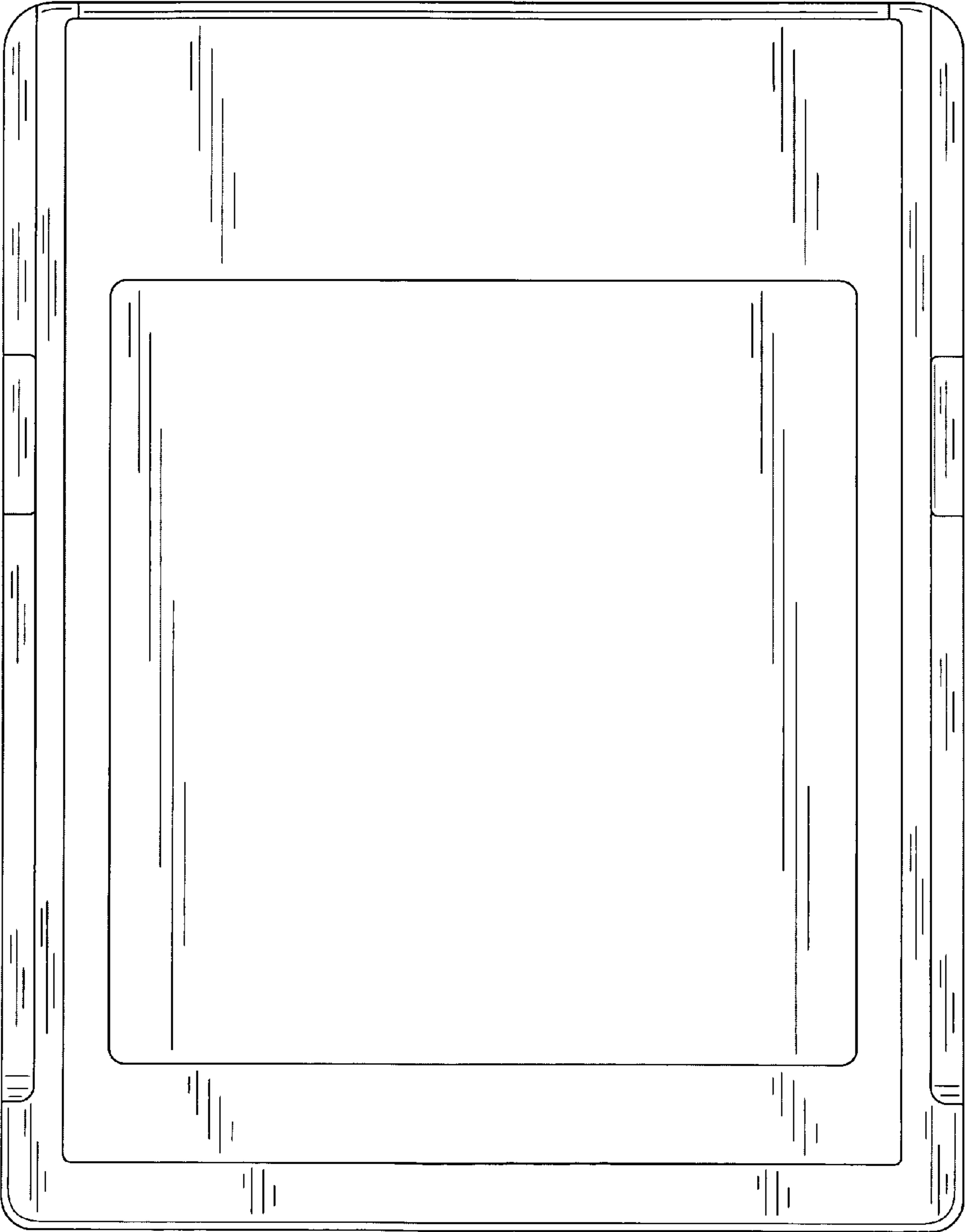

FIG.17

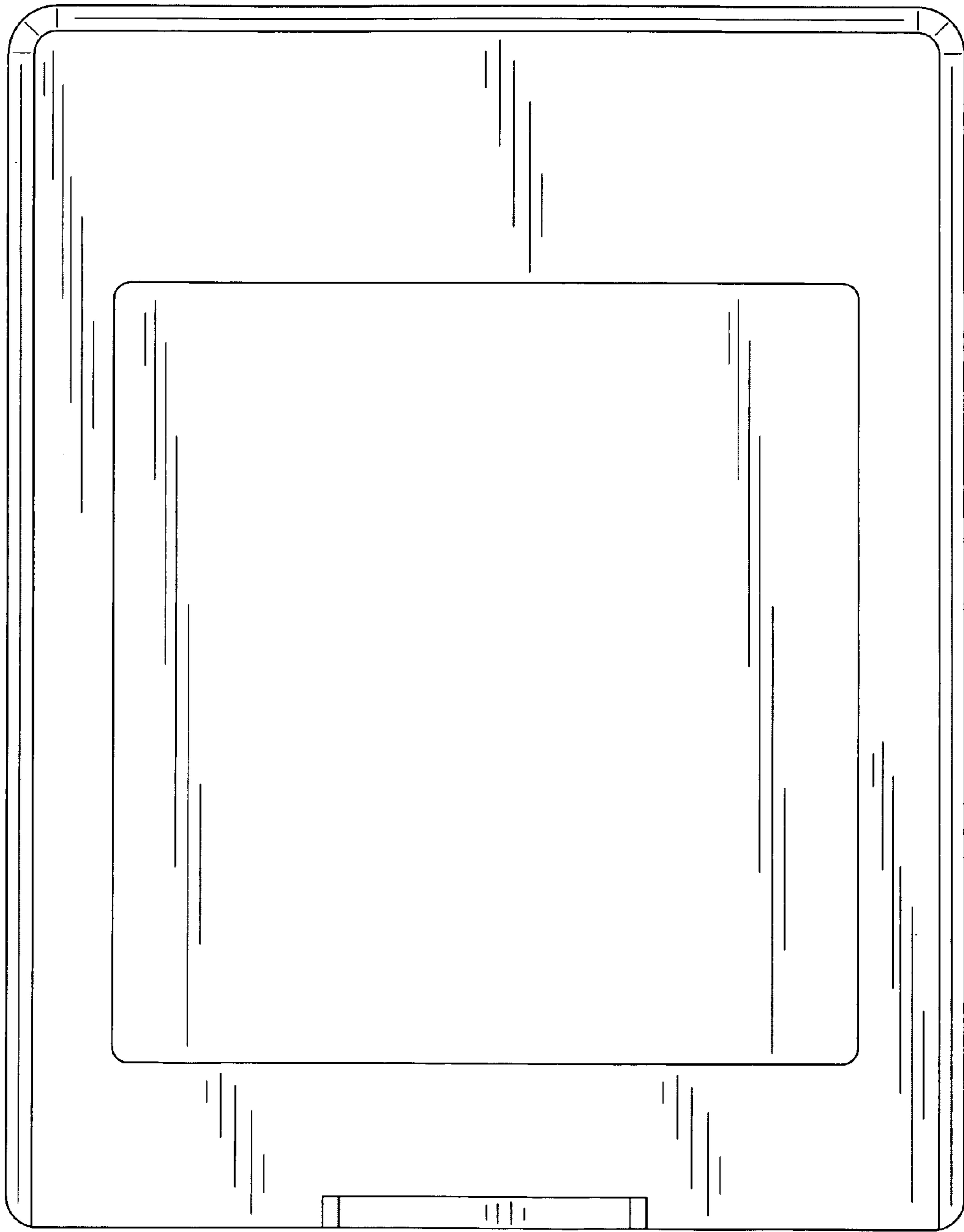

FIG. 18

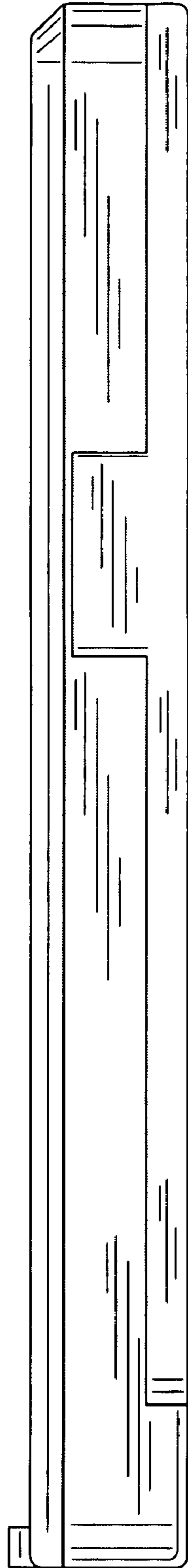

FIG.19

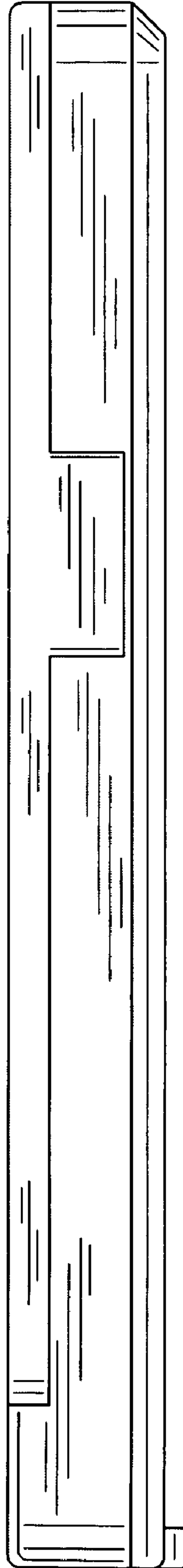

FIG.20

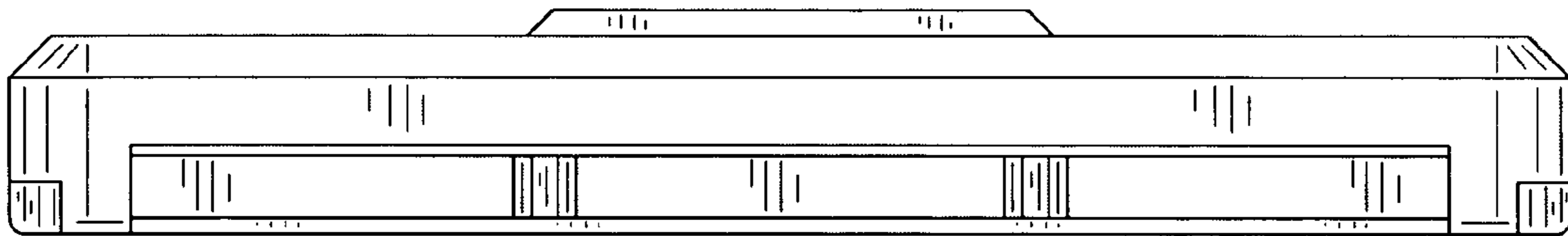

FIG.21

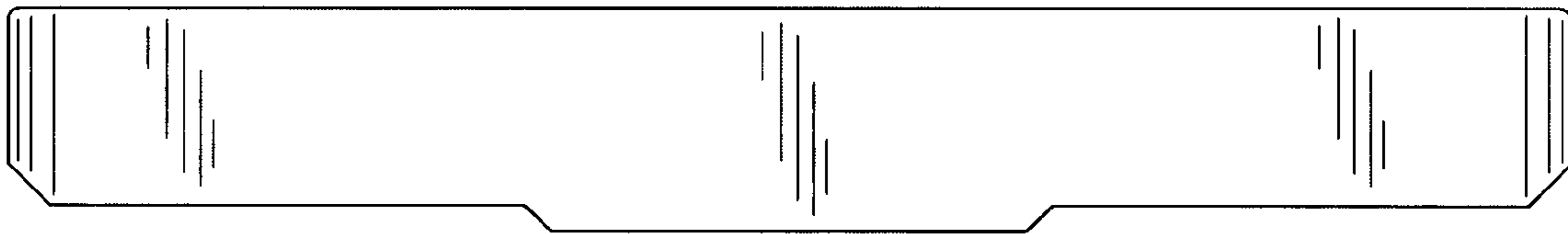

FIG.22

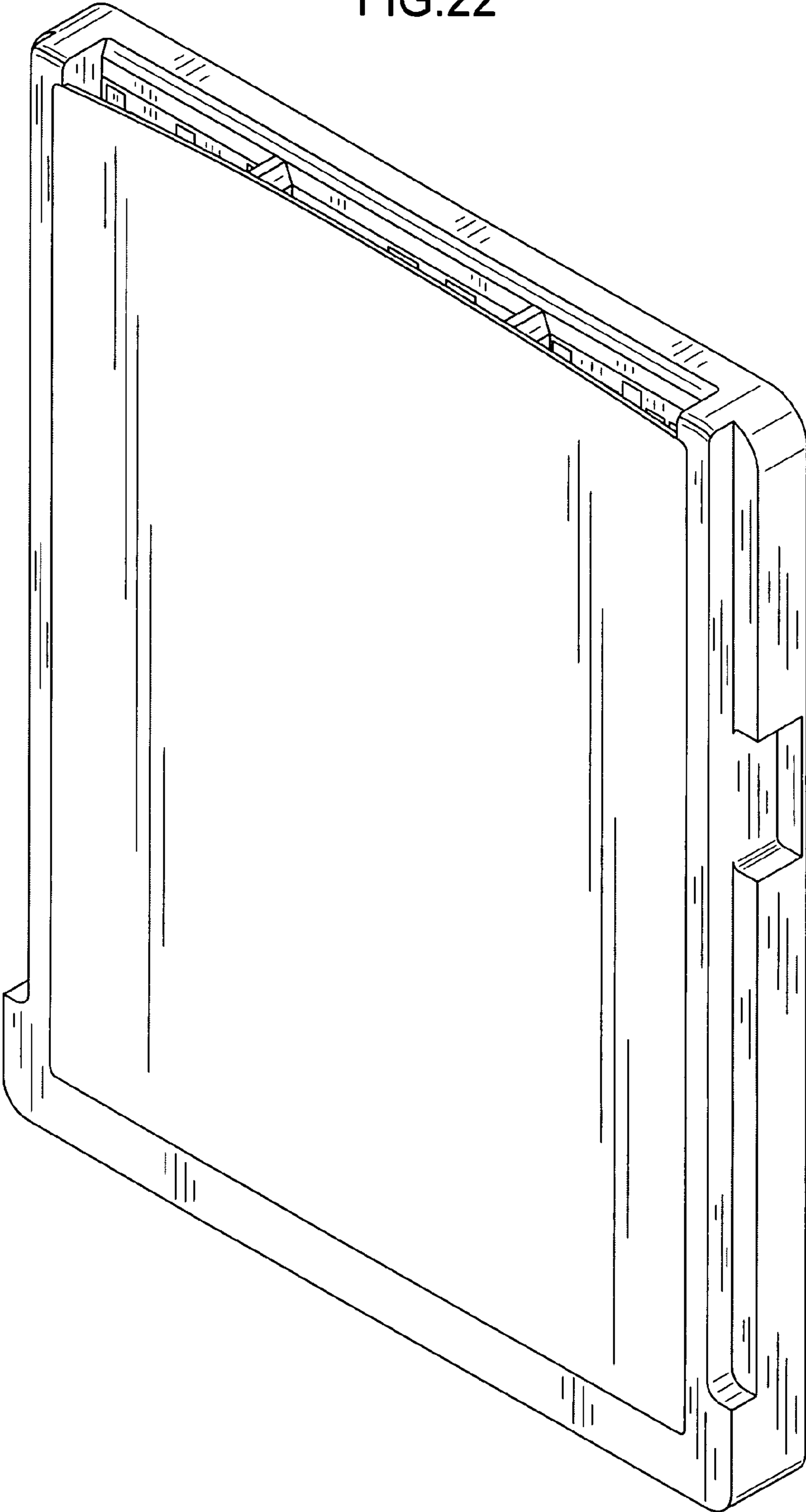

FIG.23

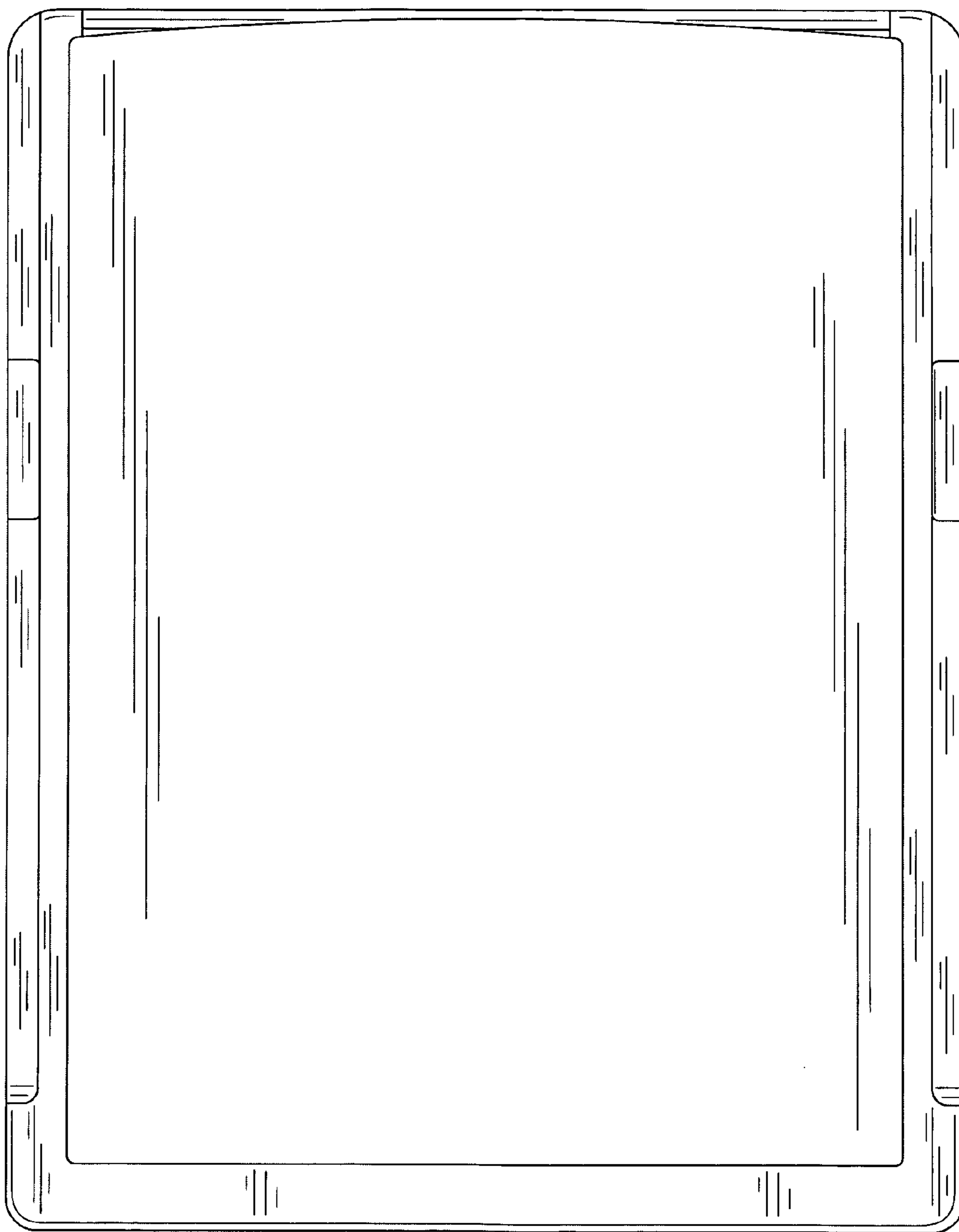

FIG.24

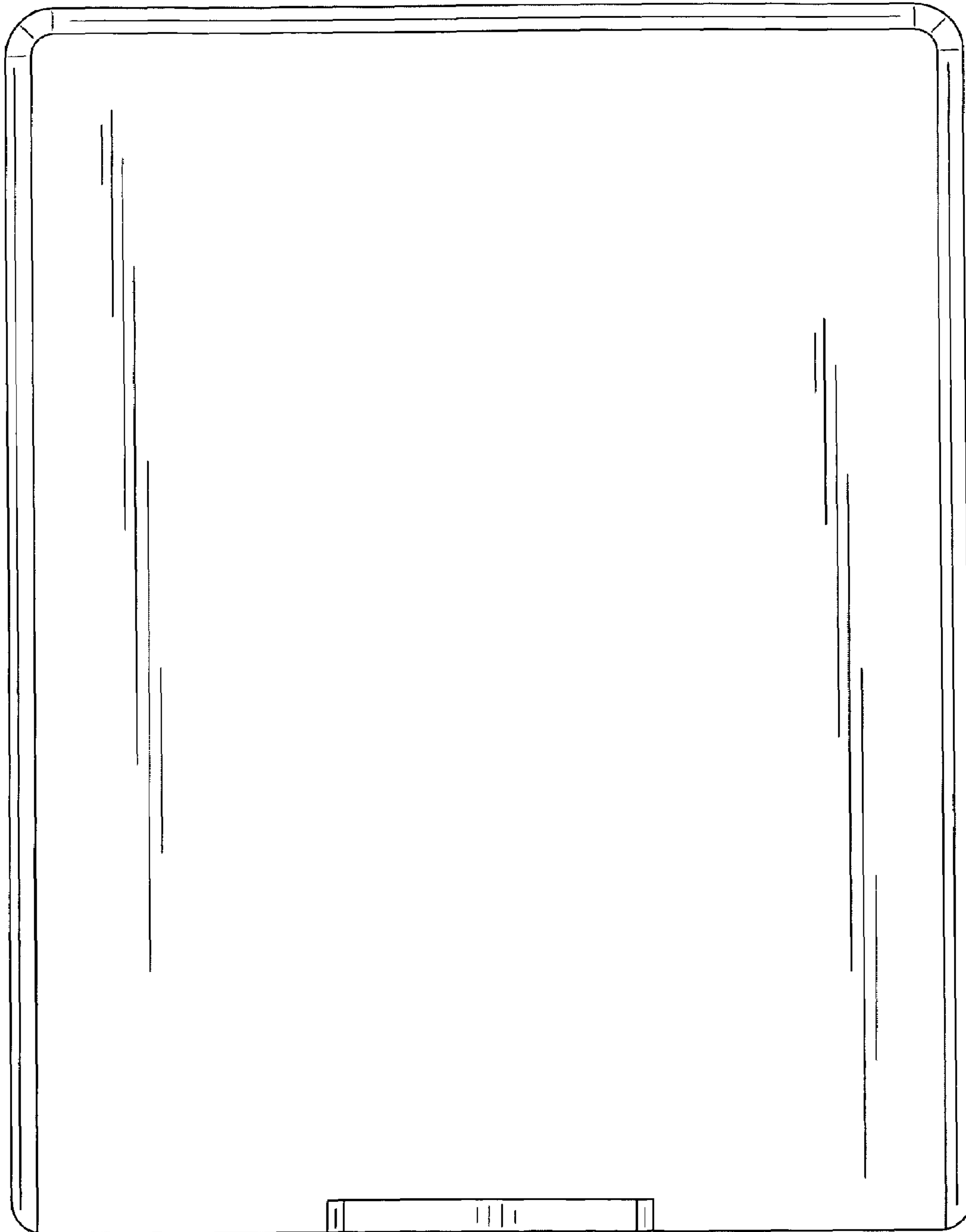

FIG.25

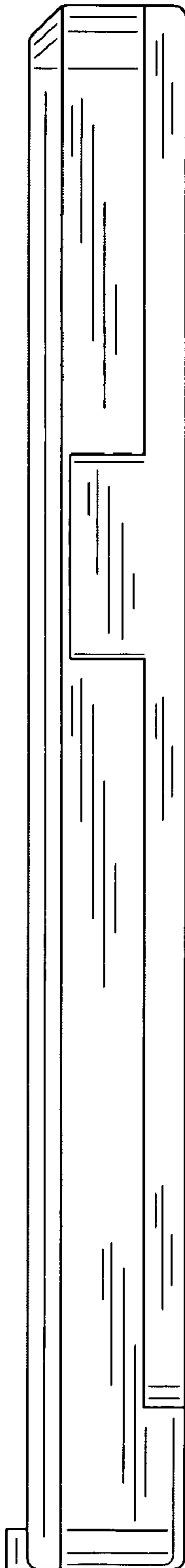

FIG.26

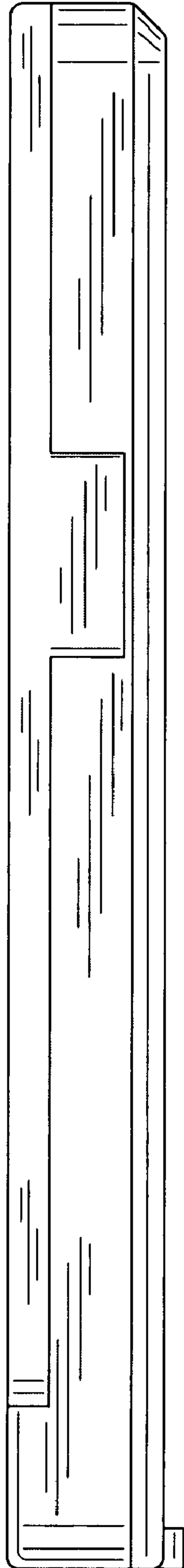

FIG.27

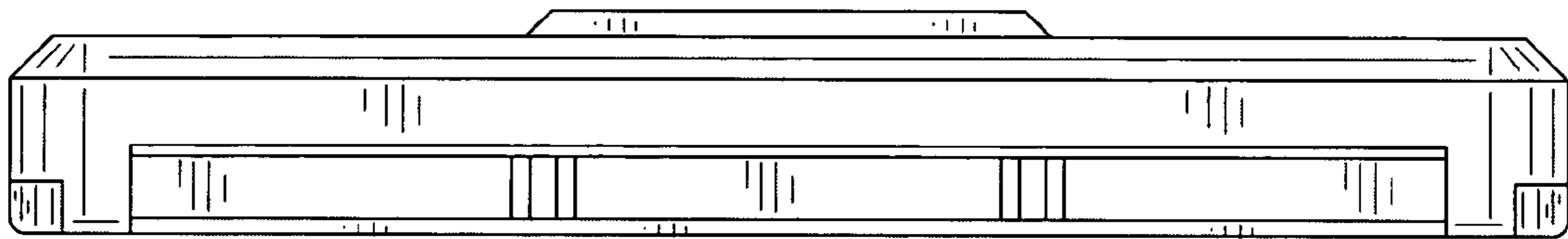

FIG.28

