



US00D591616S

(12) **United States Design Patent**
Mora-Hernandez et al.

(10) **Patent No.:** **US D591,616 S**
(45) **Date of Patent:** **** May 5, 2009**

(54) **CONTAINER FOR SWEET PASTES**

(76) Inventors: **Carlos Mora-Hernandez**, Pelicano No. 818, Col. Morelos, Guadalajara, Jalisco (MX) 44910; **Carlos Mora-Casillas**, Pelicano No. 818, Col. Morelos, Guadalajara, Jalisco (MX) 44910

D335,256 S * 5/1993 Slavin et al. D9/724
D343,791 S * 2/1994 Pitaknarongphorn D9/724
D356,597 S * 3/1995 Gray D9/724
D378,406 S * 3/1997 Kugler D24/114
D381,900 S * 8/1997 Hundertmark et al. D9/724
D415,959 S * 11/1999 Antoine D9/724
D471,797 S * 3/2003 Guerrero et al. D9/724
D489,819 S * 5/2004 Ford D24/114

(**) Term: **14 Years**

* cited by examiner

(21) Appl. No.: **29/321,455**

Primary Examiner—Stella M Reid
Assistant Examiner—Shanda C Hill

(22) Filed: **Jul. 16, 2008**

(74) *Attorney, Agent, or Firm*—Browdy and Neimark, PLLC

(30) **Foreign Application Priority Data**

(57) **CLAIM**

Apr. 2, 2008 (MX) MX/F/2008/000738

The ornamental design for a container for sweet pastes, as shown and described.

(51) **LOC (9) Cl.** **09-03**

(52) **U.S. Cl.** **D9/724**

(58) **Field of Classification Search** D9/723, D9/724, 727, 729; D7/300, 300.1, 312, 313, D7/665–669; D24/114, 130; D28/4, 9, 10, D28/20; 215/6, 10; 206/219–221, 568; 222/94, 222/95, 105, 212, 325, 386.5; 604/218
See application file for complete search history.

DESCRIPTION

FIG. 1 is a top perspective view of a container for sweet pastes showing our new design;

FIG. 2 is a left side view thereof; right side view being a mirror image thereof;

FIG. 3 is a front view thereof; rear view being a mirror image thereof;

FIG. 4 is a top view thereof;

FIG. 5 is a bottom view thereof; and

FIG. 6 is a bottom perspective view thereof; and,

FIG. 7 is an exploded view thereof.

(56) **References Cited**

U.S. PATENT DOCUMENTS

D232,296 S * 8/1974 McNair D7/669
3,884,231 A * 5/1975 Peters 604/218
D262,739 S * 1/1982 Nitshke D24/130
D312,768 S * 12/1990 Eastman D9/724
D331,874 S * 12/1992 Schmidt D9/724

1 Claim, 6 Drawing Sheets

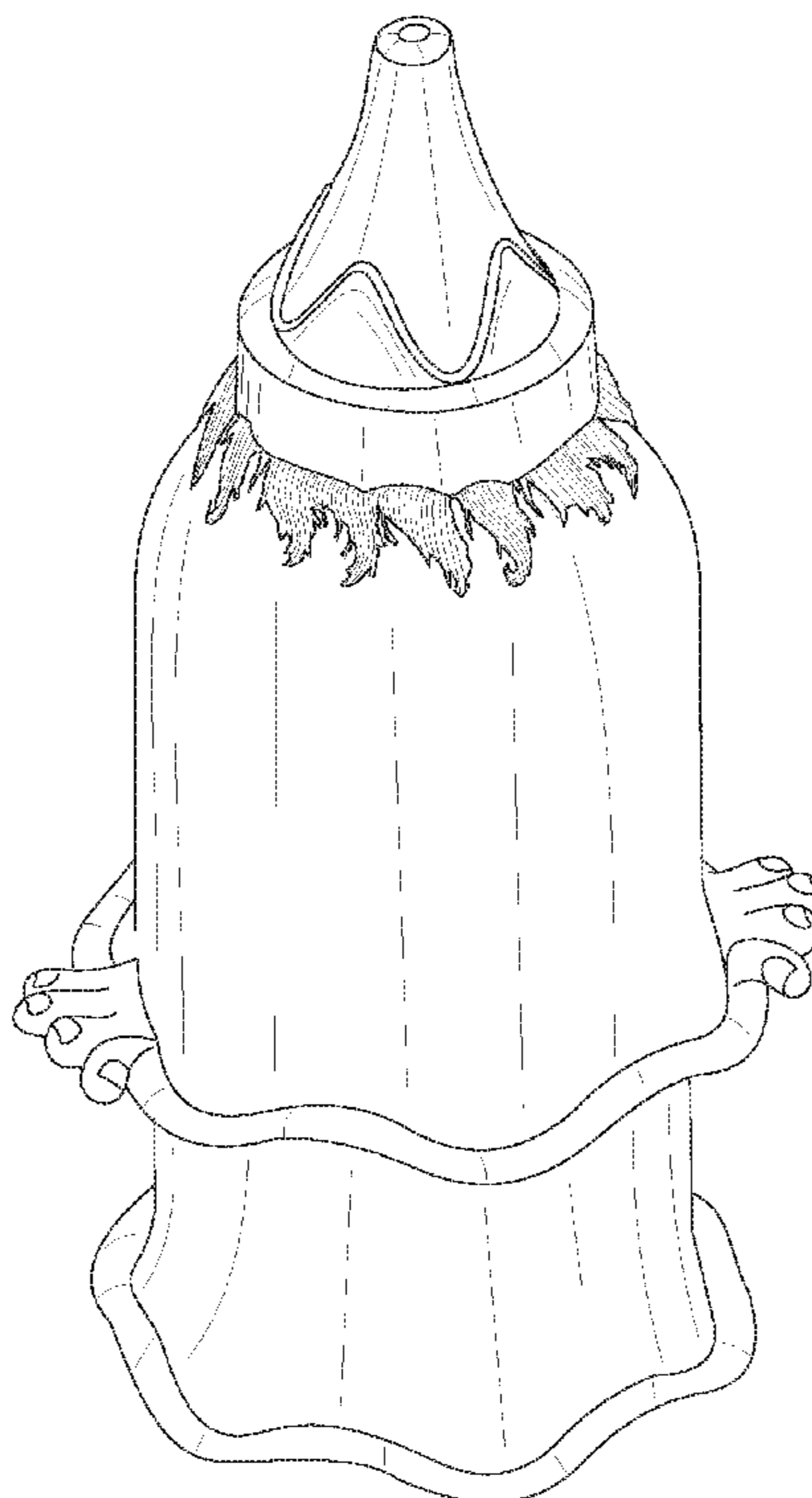



FIG. 1

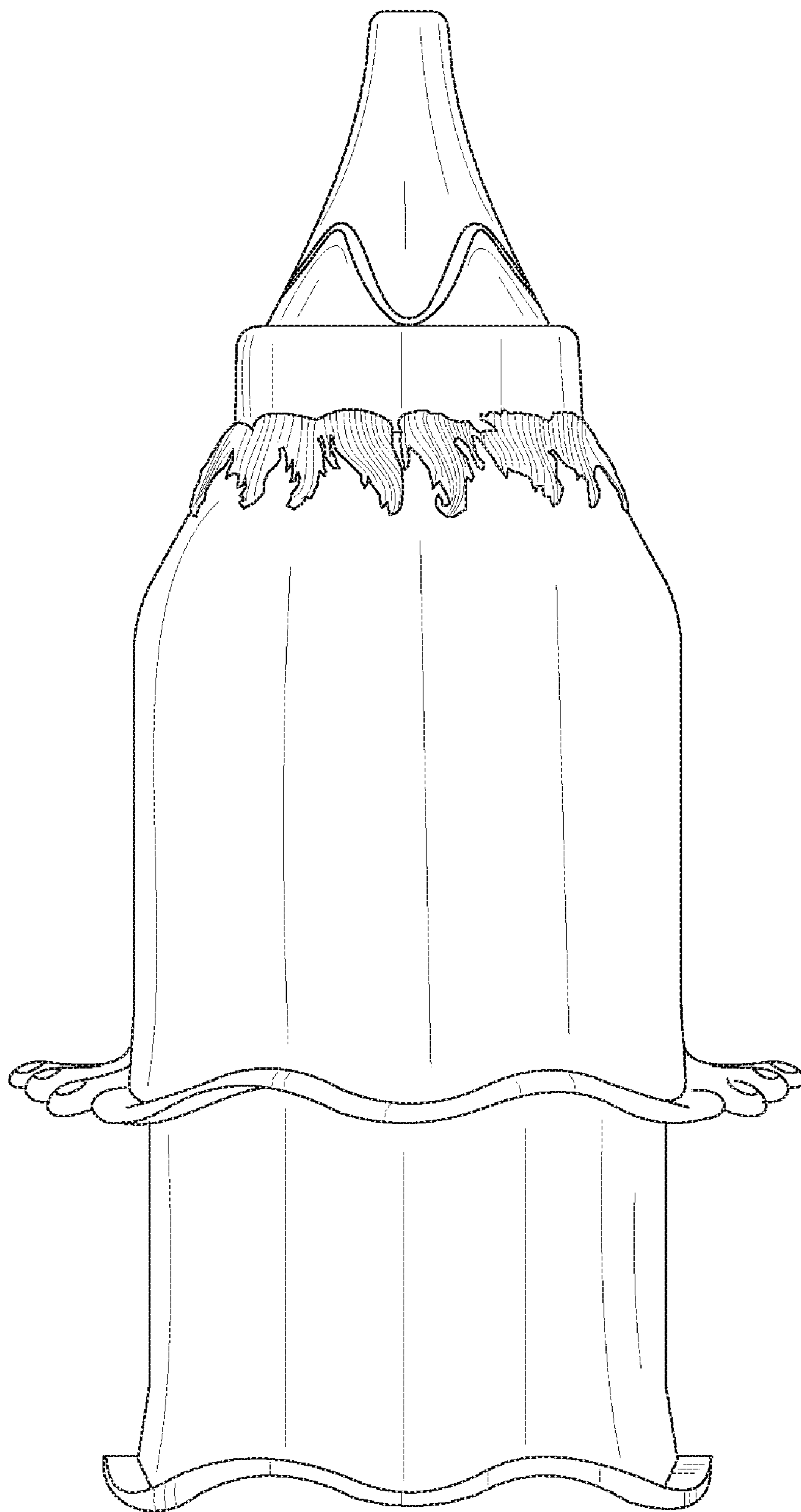

FIG. 2

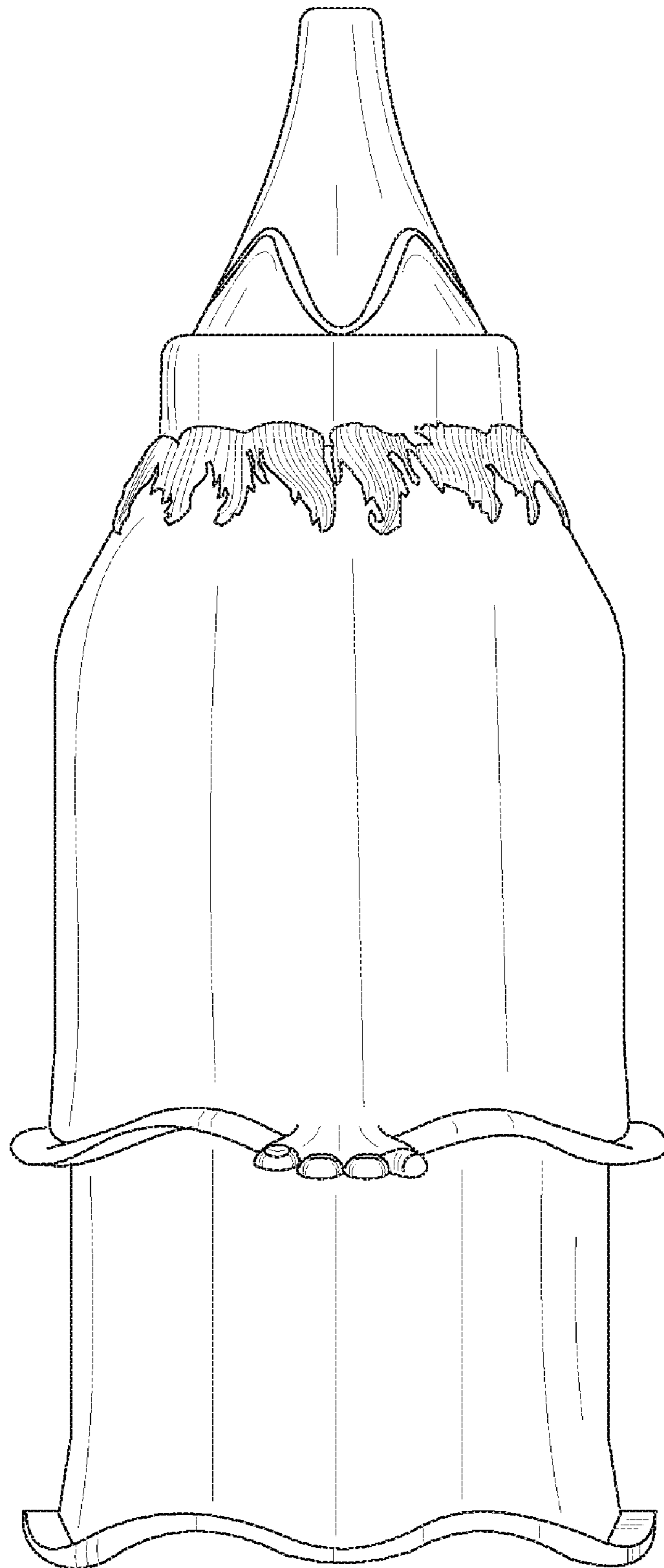

FIG. 3

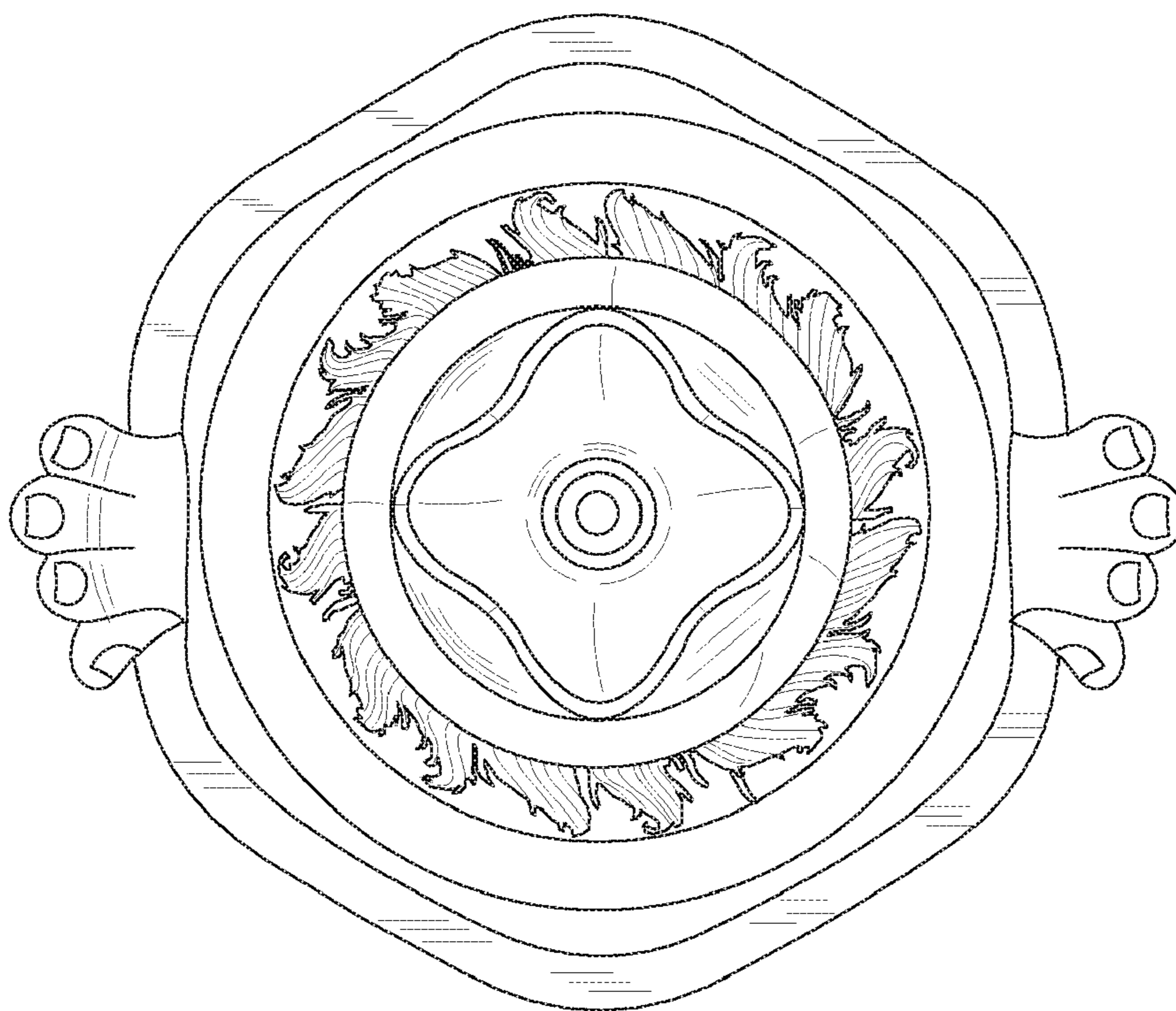

FIG. 4

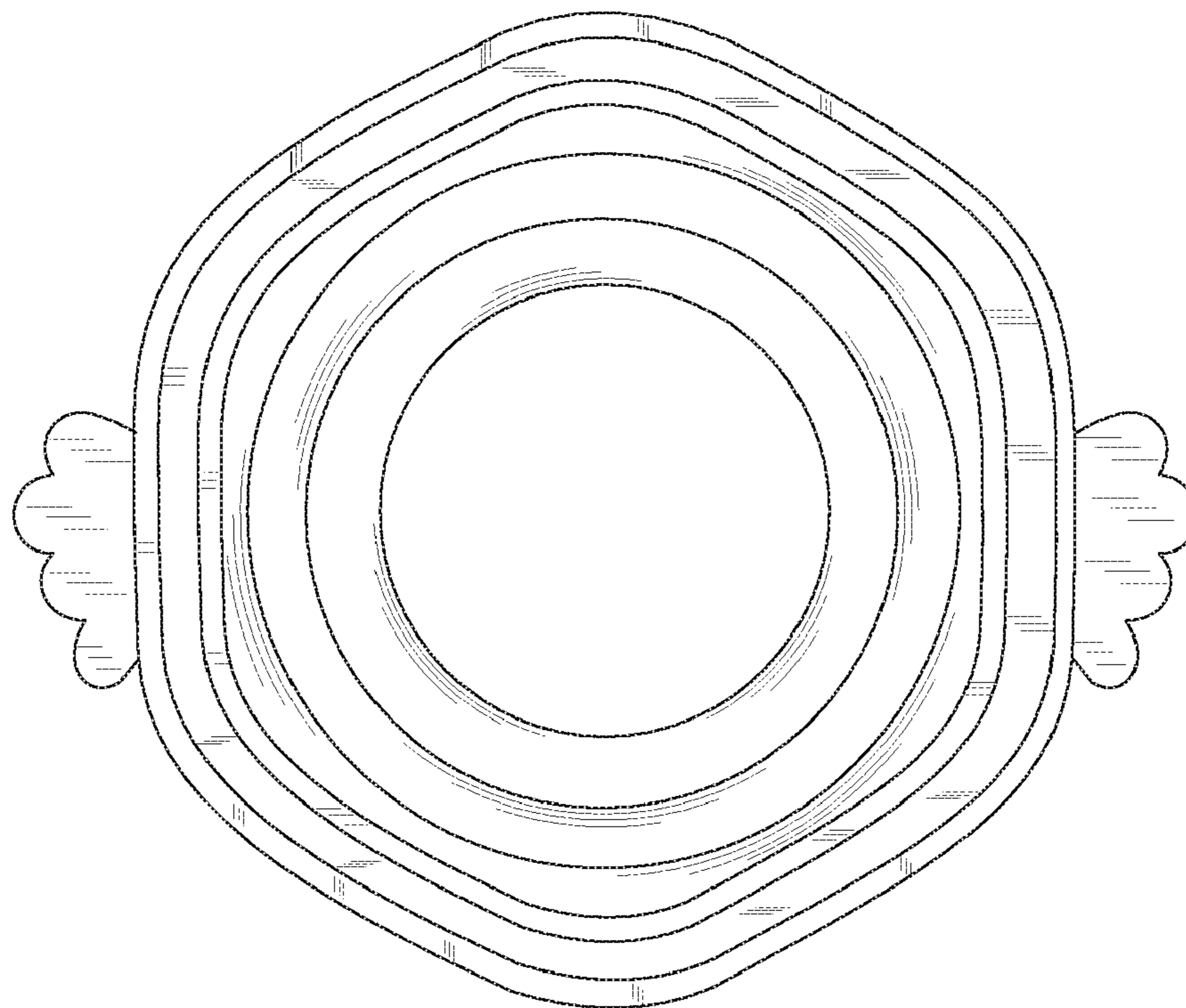

FIG. 5

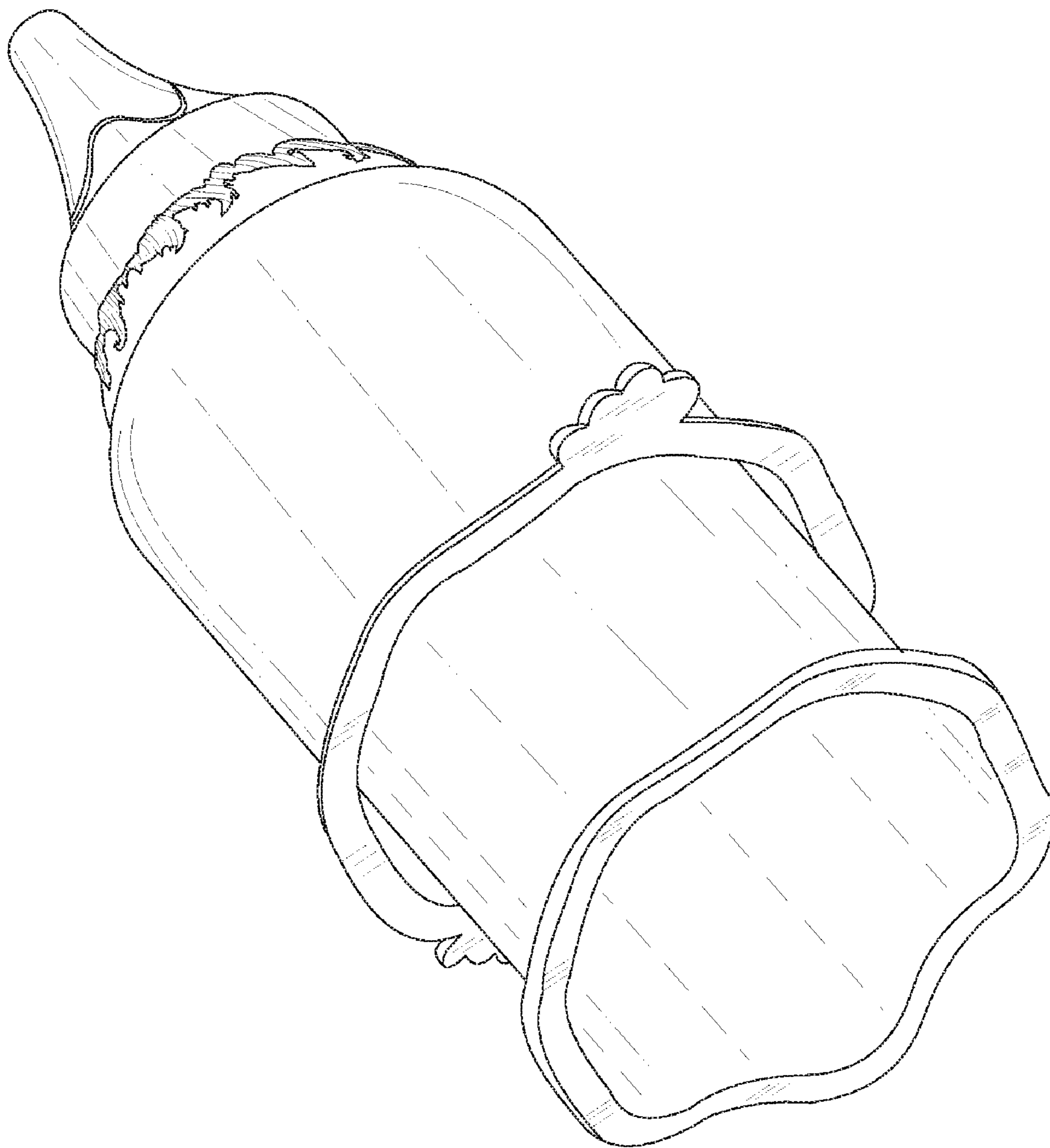

FIG. 6

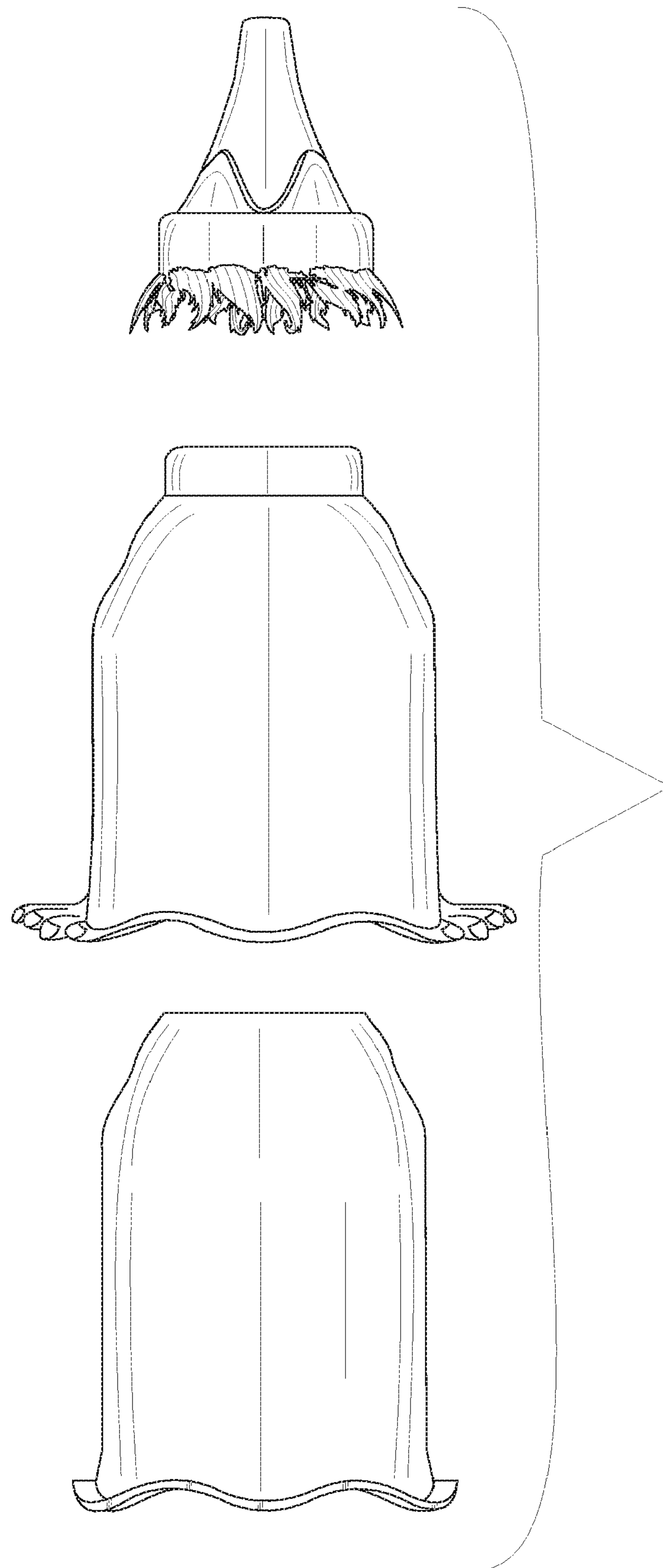

FIG. 7