

US00D591609S

(12) **United States Design Patent**
Shmagin

(10) **Patent No.:** **US D591,609 S**

(45) **Date of Patent:** **** May 5, 2009**

(54) **BOTTLE**

D525,530 S * 7/2006 Livingston et al. D9/538

(75) Inventor: **Dmitriy L. Shmagin**, Palatine, IL (US)

* cited by examiner

(73) Assignee: **Stokely-Van Camp, Inc.**, Chicago, IL (US)

Primary Examiner—Sandra Morris
(74) *Attorney, Agent, or Firm*—Banner & Witcoff, Ltd.

(**) Term: **14 Years**

(57) **CLAIM**

(21) Appl. No.: **29/325,037**

The ornamental design for a bottle, as shown and described.

(22) Filed: **Sep. 25, 2008**

DESCRIPTION

Related U.S. Application Data

(62) Division of application No. 29/252,626, filed on Jan. 25, 2006, now Pat. No. Des. 579,339.

FIG. 1 is a perspective view of a first embodiment of my new design for a bottle;

(51) **LOC (9) Cl.** **09-01**

(52) **U.S. Cl.** **D9/667; D9/551; D9/553**

FIG. 2 is a front elevation view of the bottle of FIG. 1;

(58) **Field of Classification Search** D9/600,
D9/652, 667, 434, 500–503, 516–520, 537–543,
D9/549–553, 556–566, 569–570; 215/379–383,
215/375, 400; 220/890

FIG. 3 is a side elevation view of the bottle of FIG. 2 rotated 90° clockwise;

See application file for complete search history.

FIG. 4 is a side elevation view of the bottle of FIG. 2 rotated 45° clockwise;

(56) **References Cited**

U.S. PATENT DOCUMENTS

- D321,830 S * 11/1991 York et al. D9/434
- 6,016,932 A * 1/2000 Gaydosh et al. 215/382
- D419,882 S * 2/2000 Bretz et al. D9/520
- 6,036,037 A * 3/2000 Scheffer et al. 215/381
- 6,044,996 A * 4/2000 Carew et al. 215/381
- D465,158 S * 11/2002 Peek et al. D9/538
- D497,796 S * 11/2004 Bretz et al. D9/667
- D499,959 S * 12/2004 Bretz et al. D9/667
- D504,618 S * 5/2005 Bretz et al. D9/667
- D505,333 S * 5/2005 Bretz et al. D9/667
- D505,334 S * 5/2005 Bretz et al. D9/667
- D506,678 S * 6/2005 Bretz et al. D9/667
- D506,679 S * 6/2005 Bretz et al. D9/667
- D510,274 S * 10/2005 Bretz et al. D9/667
- D511,689 S * 11/2005 Bretz et al. D9/667
- D512,325 S * 12/2005 Bretz et al. D9/667

FIG. 5 is a top plan view of the bottle of FIG. 1;

FIG. 6 is a bottom plan view of the bottle of FIG. 1;

FIG. 7 is a perspective view of a second embodiment of the bottle;

FIG. 8 is a front elevation view of the bottle of FIG. 7;

FIG. 9 is a side elevation view of the bottle of FIG. 8 rotated 90° clockwise;

FIG. 10 is a side elevation view of the bottle of FIG. 8 rotated 45° clockwise;

FIG. 11 is a top plan view of the bottle of FIG. 7;

FIG. 12 is a bottom plan view of the bottle of FIG. 7;

FIG. 13 is a perspective view of a third embodiment of the bottle;

FIG. 14 is a front elevation view of the bottle of FIG. 13;

FIG. 15 is a side elevation view of the bottle of FIG. 14 rotated 90° clockwise;

FIG. 16 is a side elevation view of the bottle of FIG. 14 rotated 45° clockwise;

FIG. 17 is a top plan view of the bottle of FIG. 13;

FIG. 18 is a bottom plan view of the bottle of FIG. 13;

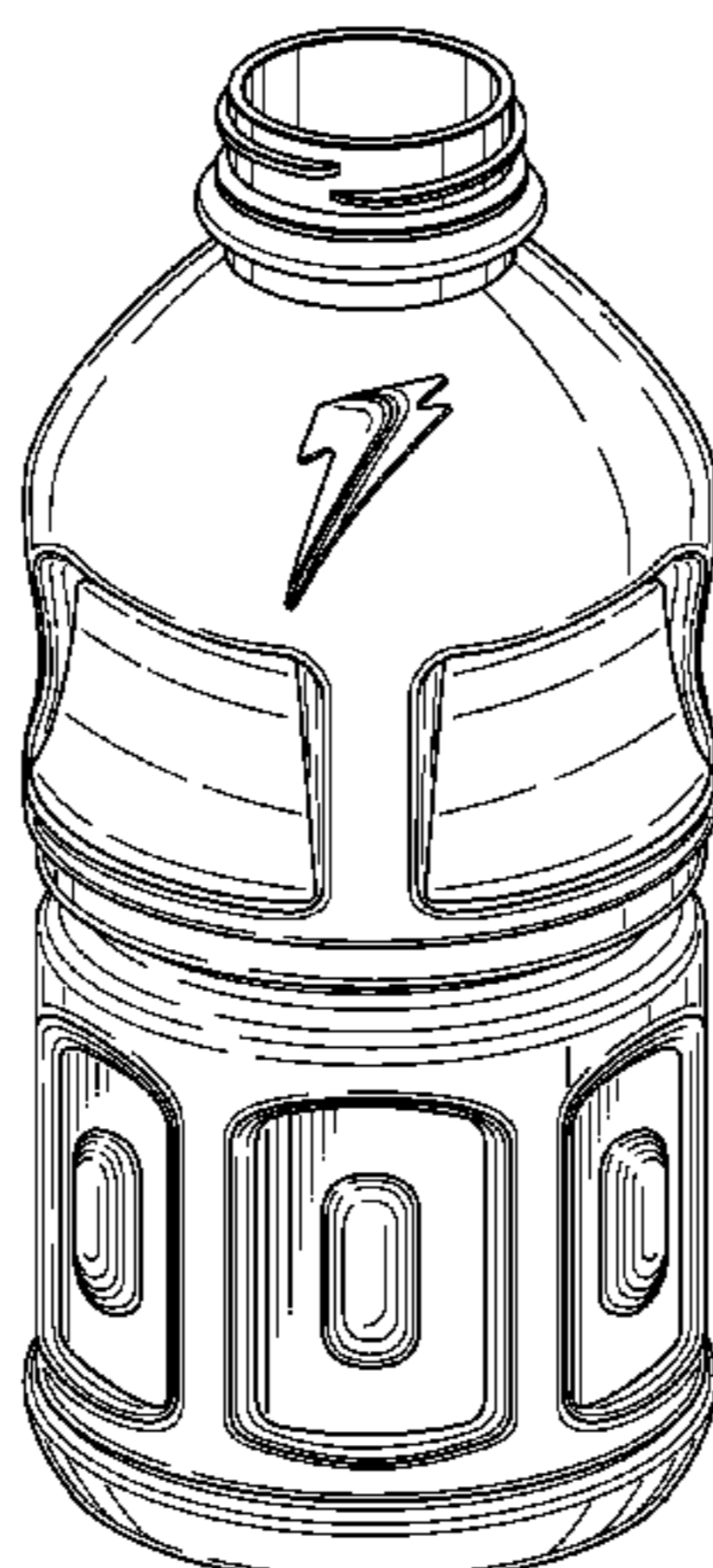

FIG. **19** is a perspective view of a fourth embodiment of the bottle;

FIG. **20** is a front elevation view of the bottle of FIG. **19**;

FIG. **21** is a side elevation view of the bottle of FIG. **20** rotated 90° clockwise;

FIG. **22** is a side elevation view of the bottle of FIG. **20** rotated 45° clockwise;

FIG. **23** is a top plan view of the bottle of FIG. **19**;

FIG. **24** is a bottom plan view of the bottle of FIG. **19**;

FIG. **25** is a perspective view of a fifth embodiment of the bottle;

FIG. **26** is a front elevation view of the bottle of FIG. **25**;

FIG. **27** is a side elevation view of the bottle of FIG. **26** rotated 90° clockwise;

FIG. **28** is a side elevation view of the bottle of FIG. **26** rotated 45° clockwise;

FIG. **29** is a top plan view of the bottle of FIG. **25**;

FIG. **30** is a bottom plan view of the bottle of FIG. **25**;

FIG. **31** is a perspective view of a sixth embodiment of the bottle;

FIG. **32** is a front elevation view of the bottle of FIG. **31**;

FIG. **33** is a side elevation view of the bottle of FIG. **32** rotated 90° clockwise;

FIG. **34** is a side elevation view of the bottle of FIG. **32** rotated 45° clockwise;

FIG. **35** is a top plan view of the bottle of FIG. **31**; and,

FIG. **36** is a bottom plan view of the bottle of FIG. **31**.

The dashed line shown in the drawings is for illustrative purposes only and forms no part of the claimed design. The dot-dash-dot line shown in the drawings defines the boundary of the claim and forms no part of the claimed design.

1 Claim, 30 Drawing Sheets

Fig. 1

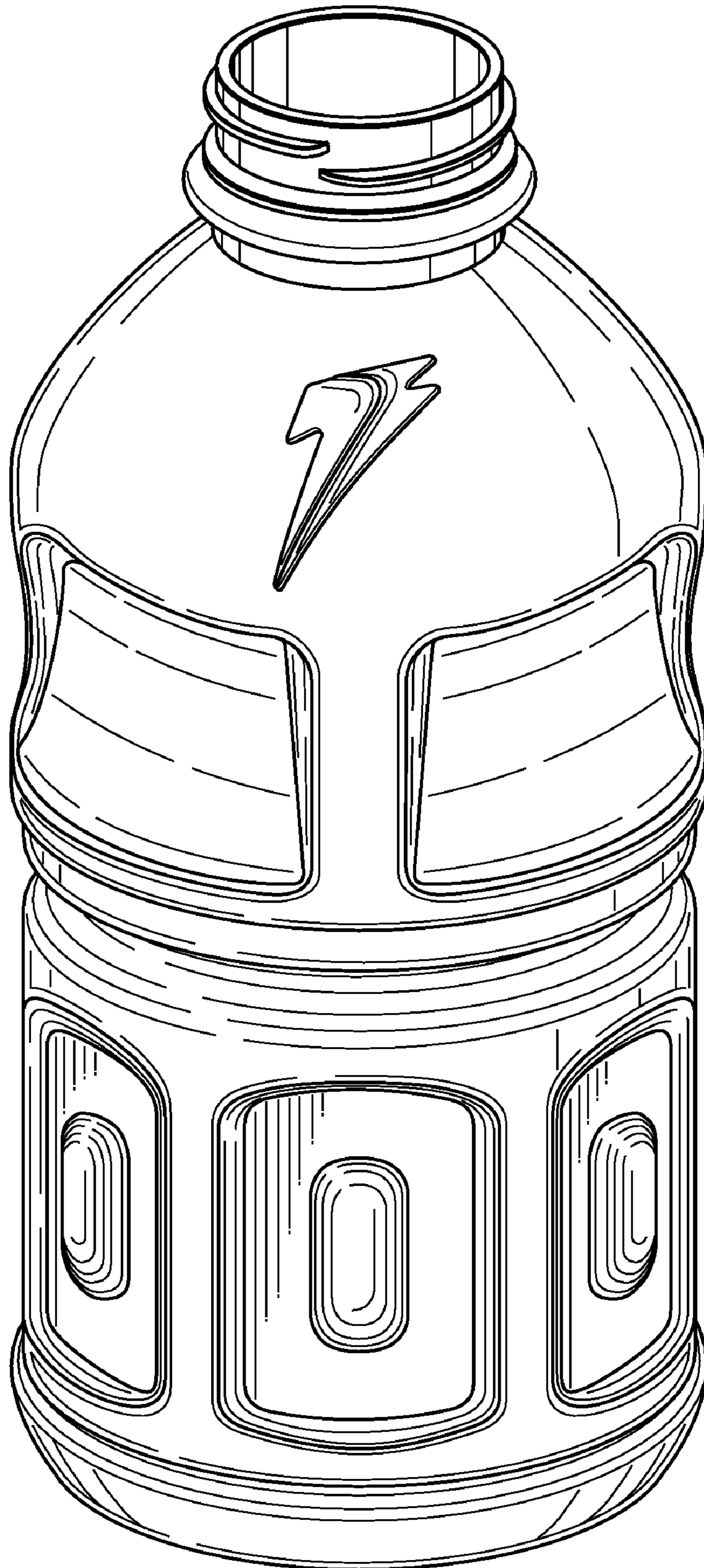

Fig. 2

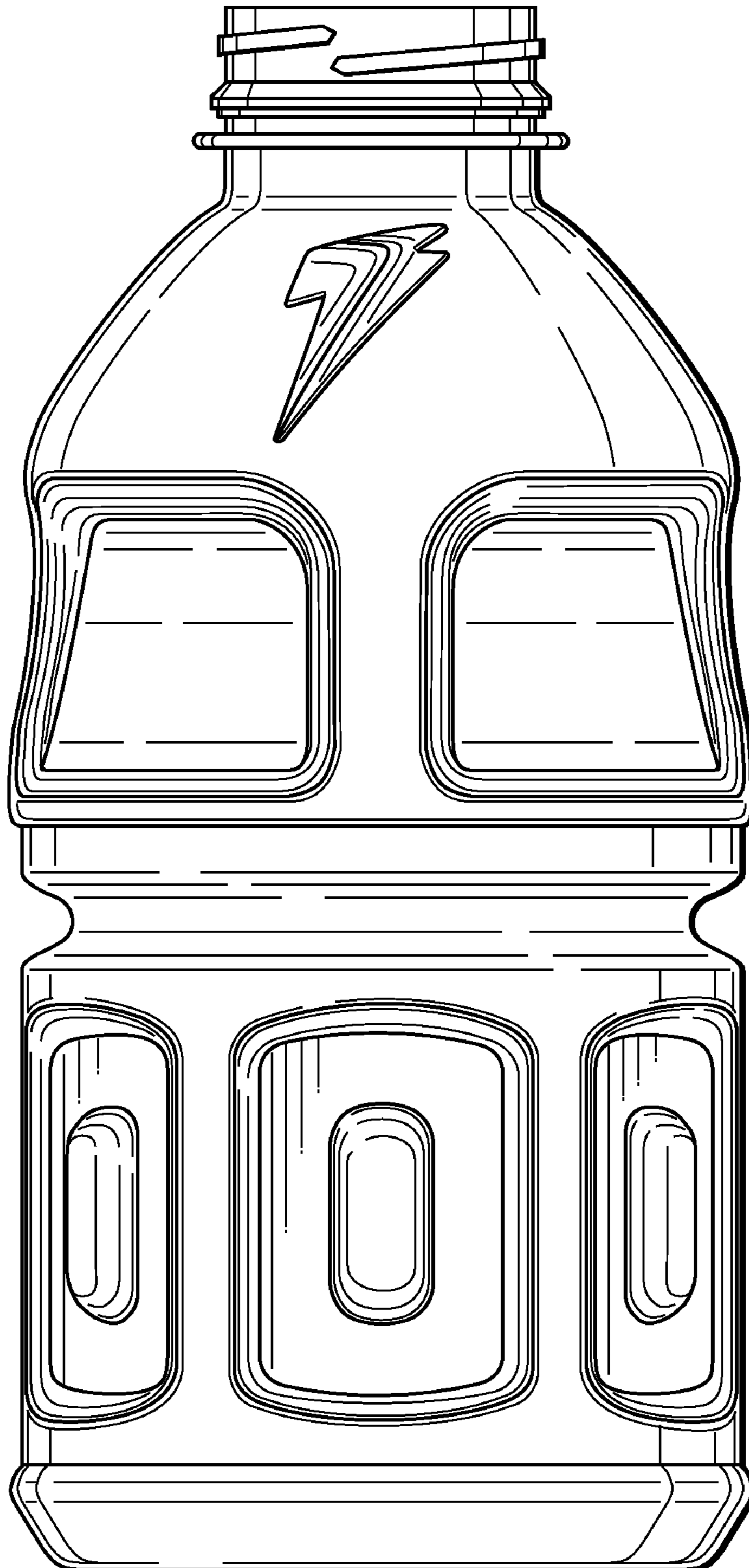

Fig. 3

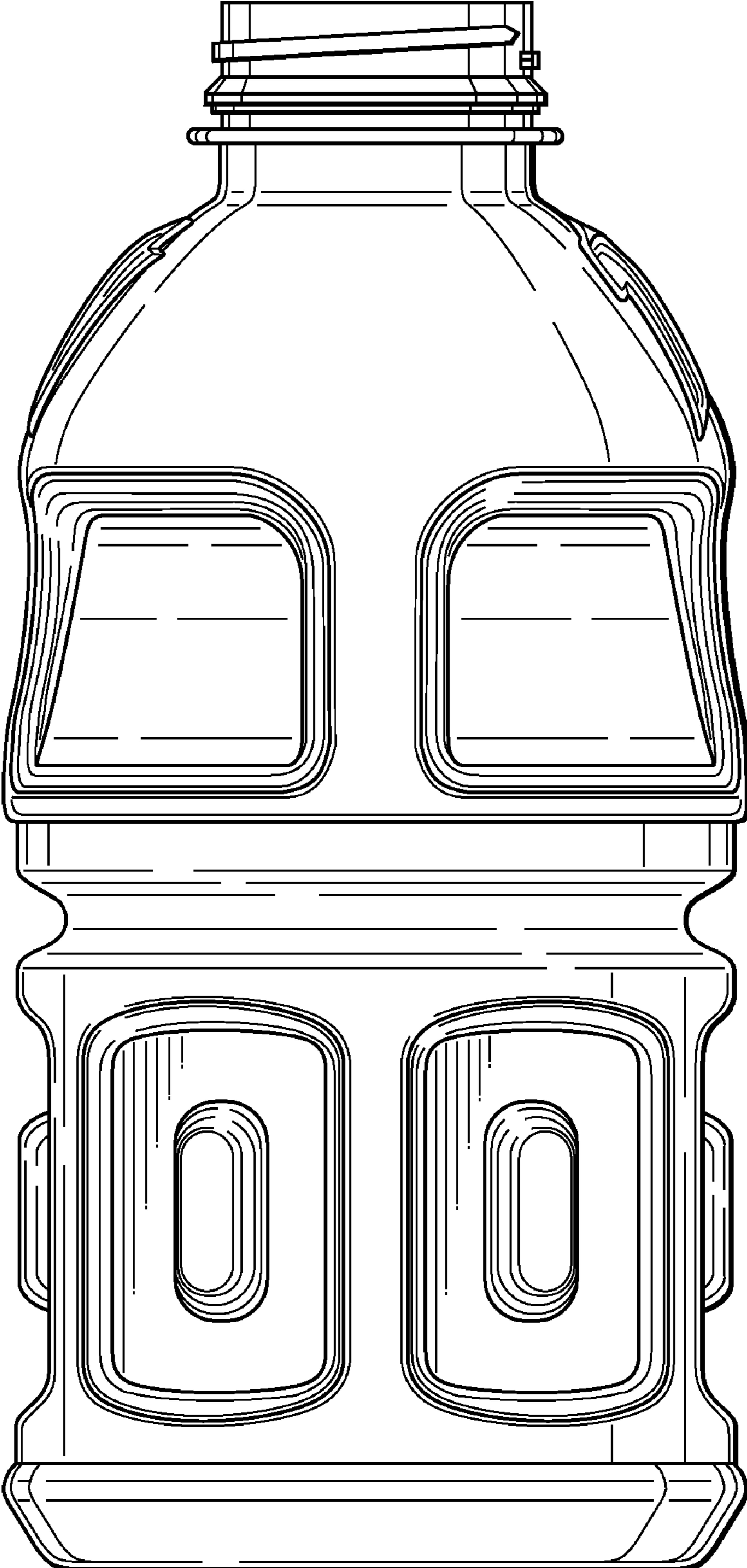

Fig. 4

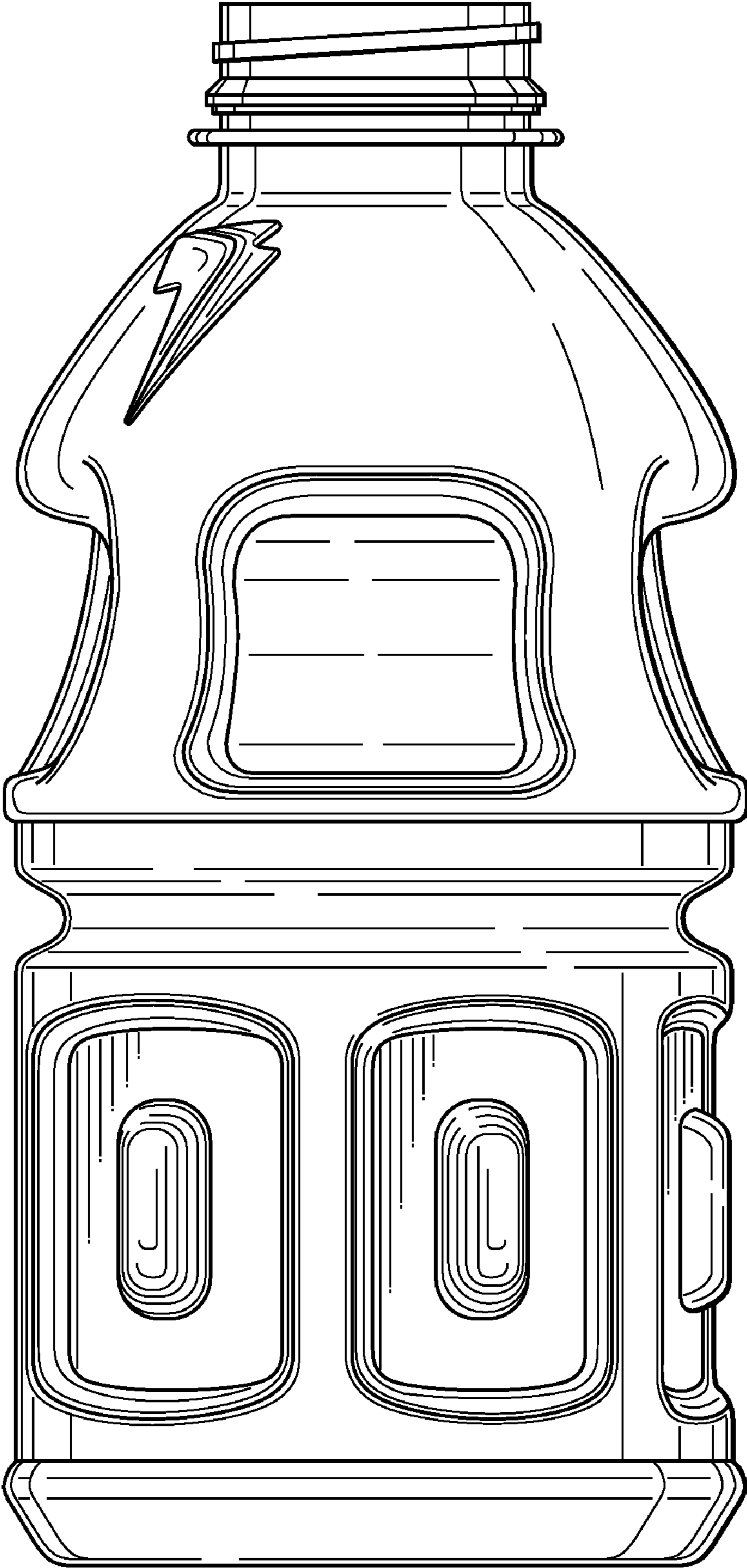

Fig. 5

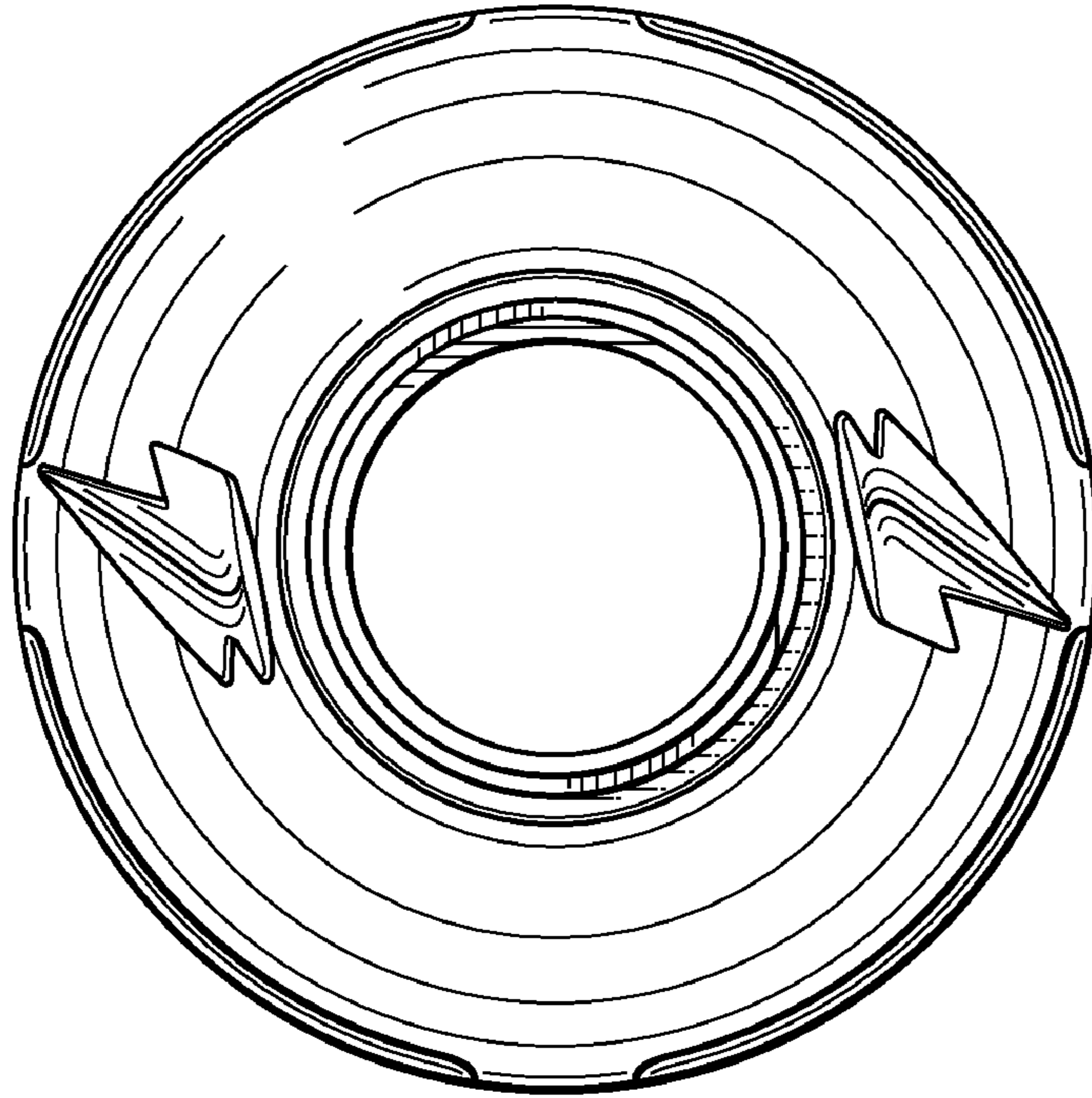

Fig. 6

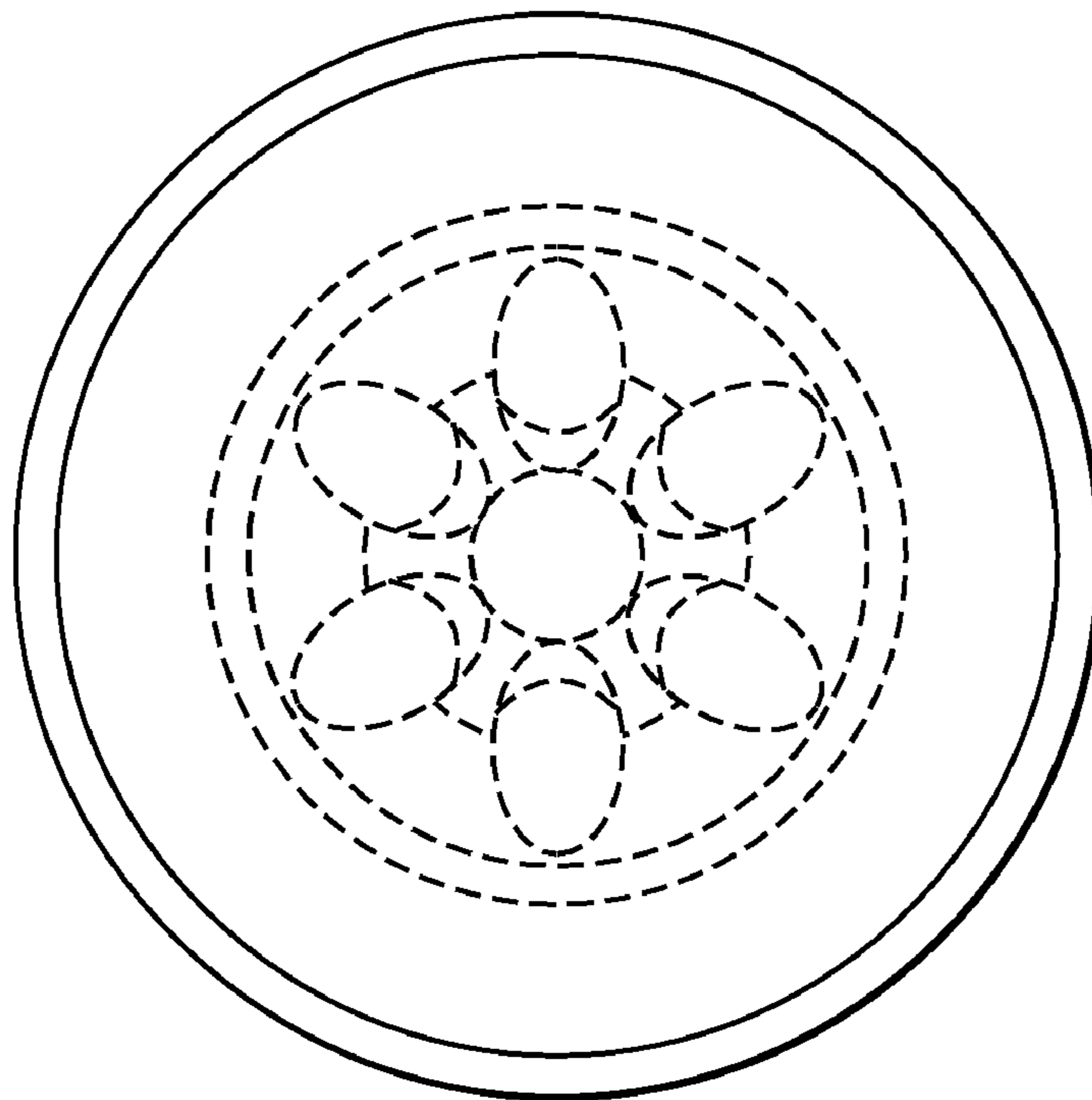

Fig. 7

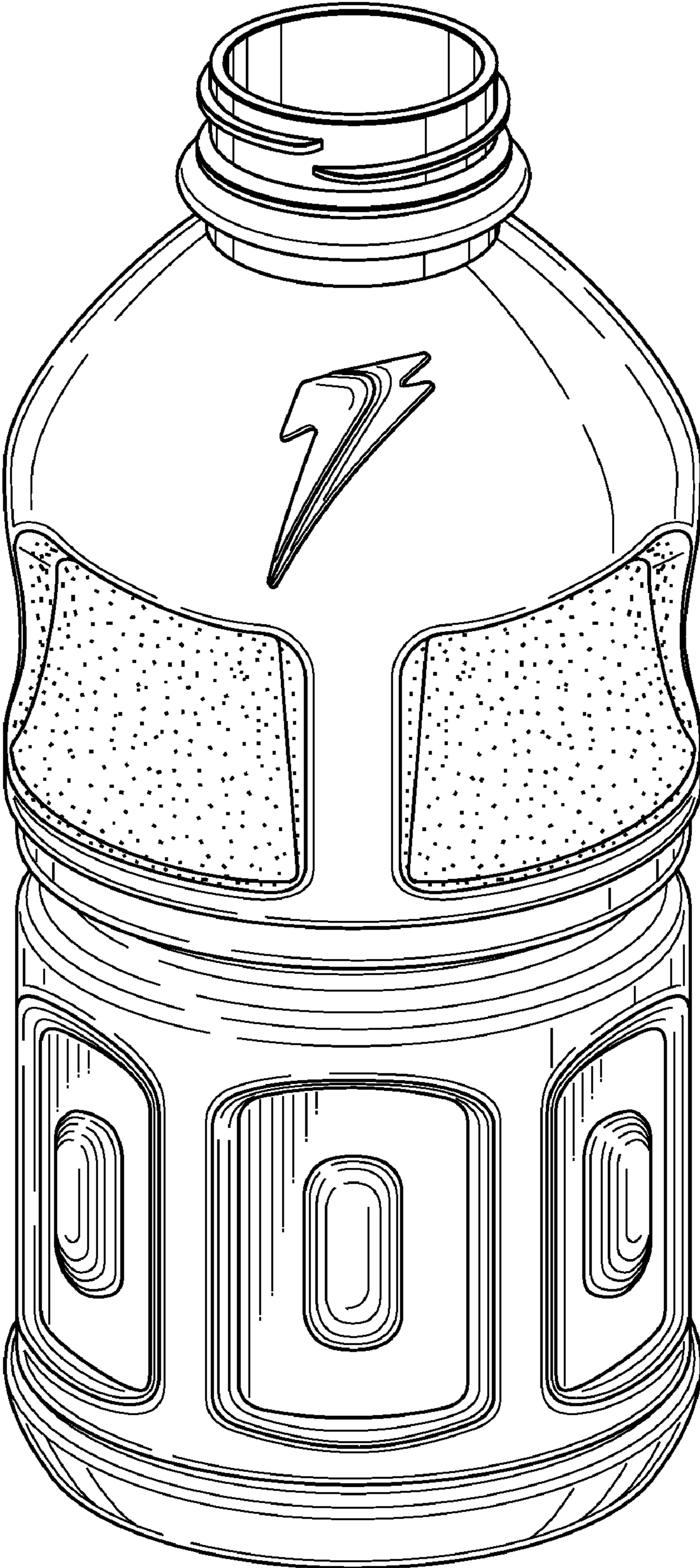

Fig. 8

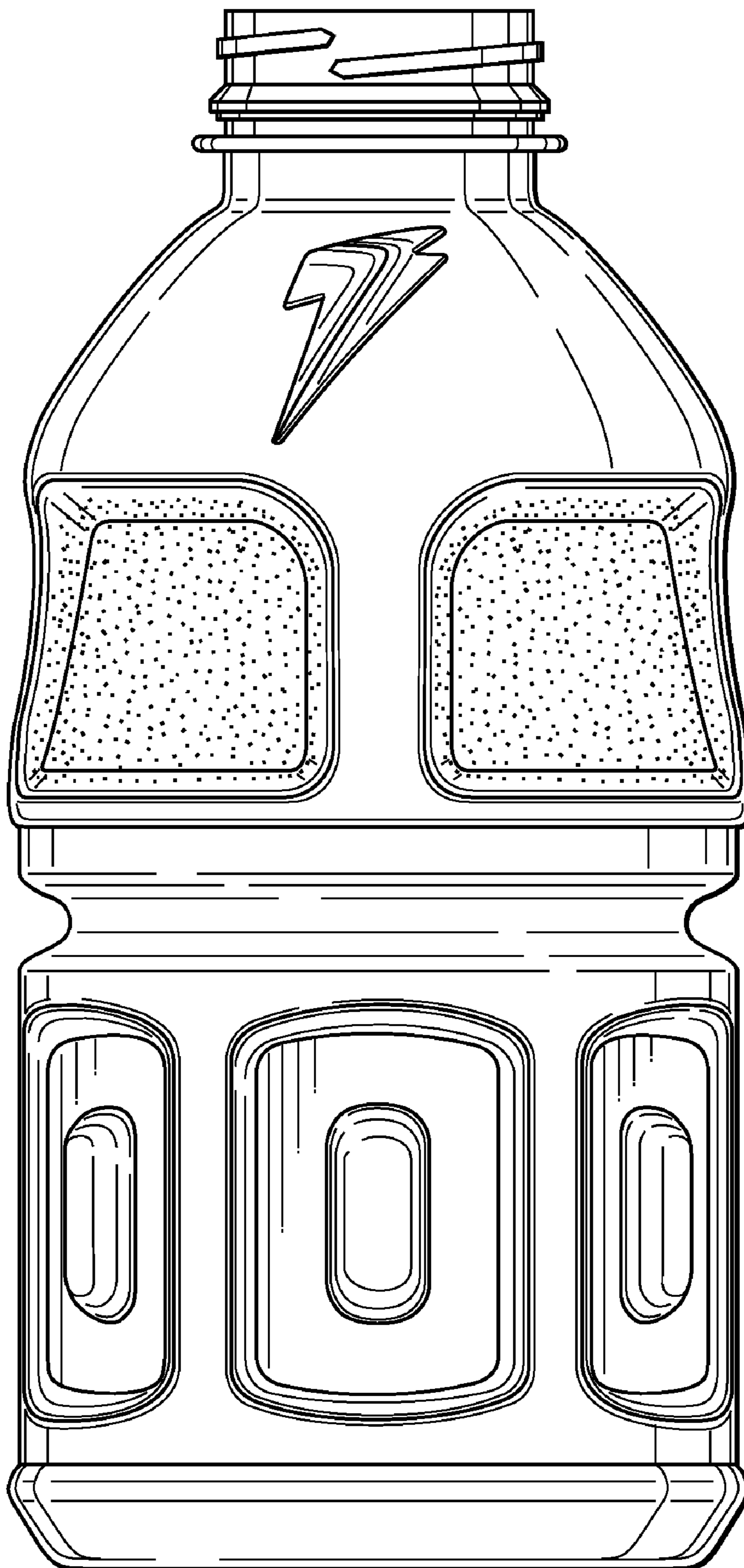

Fig. 9

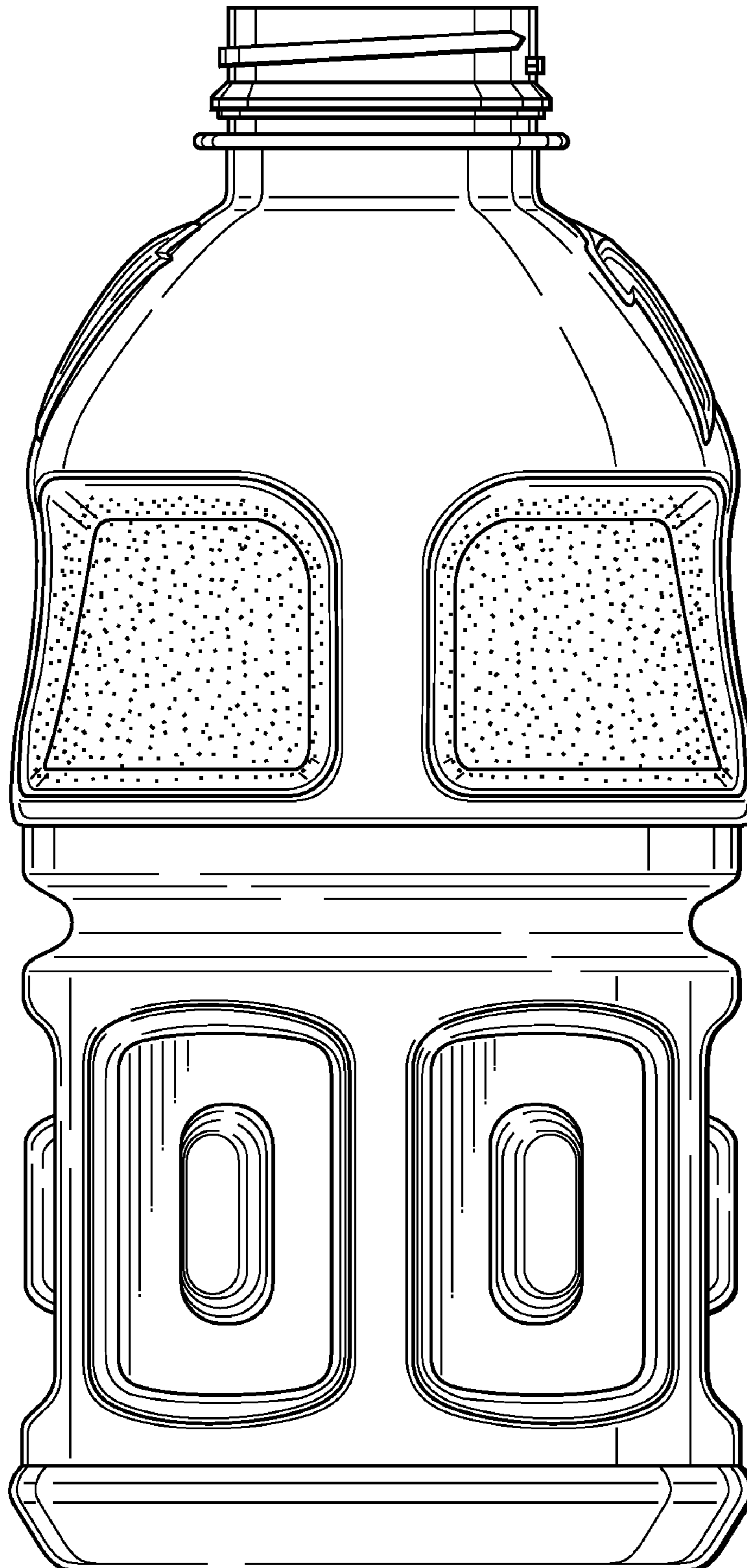

Fig. 10

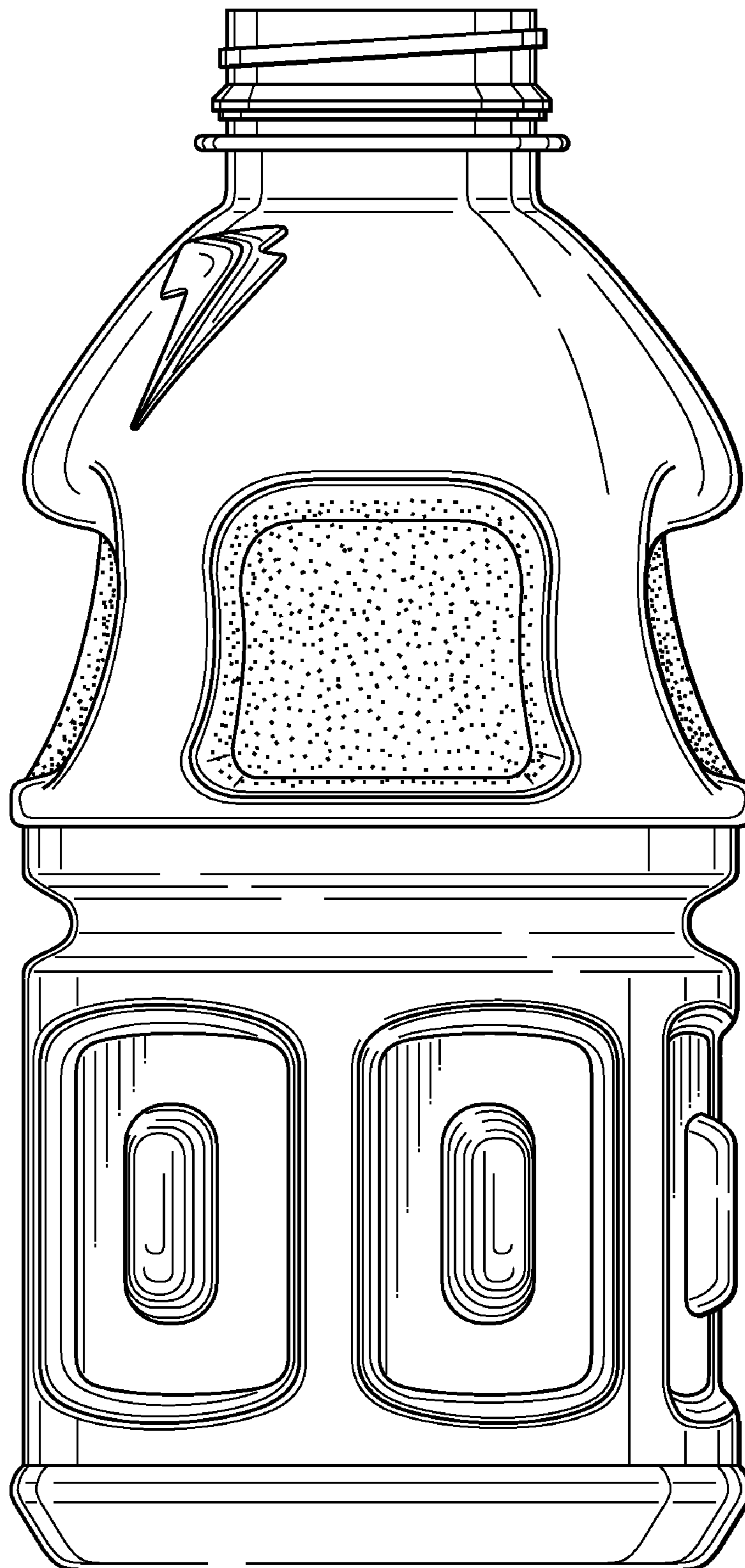

Fig. 11

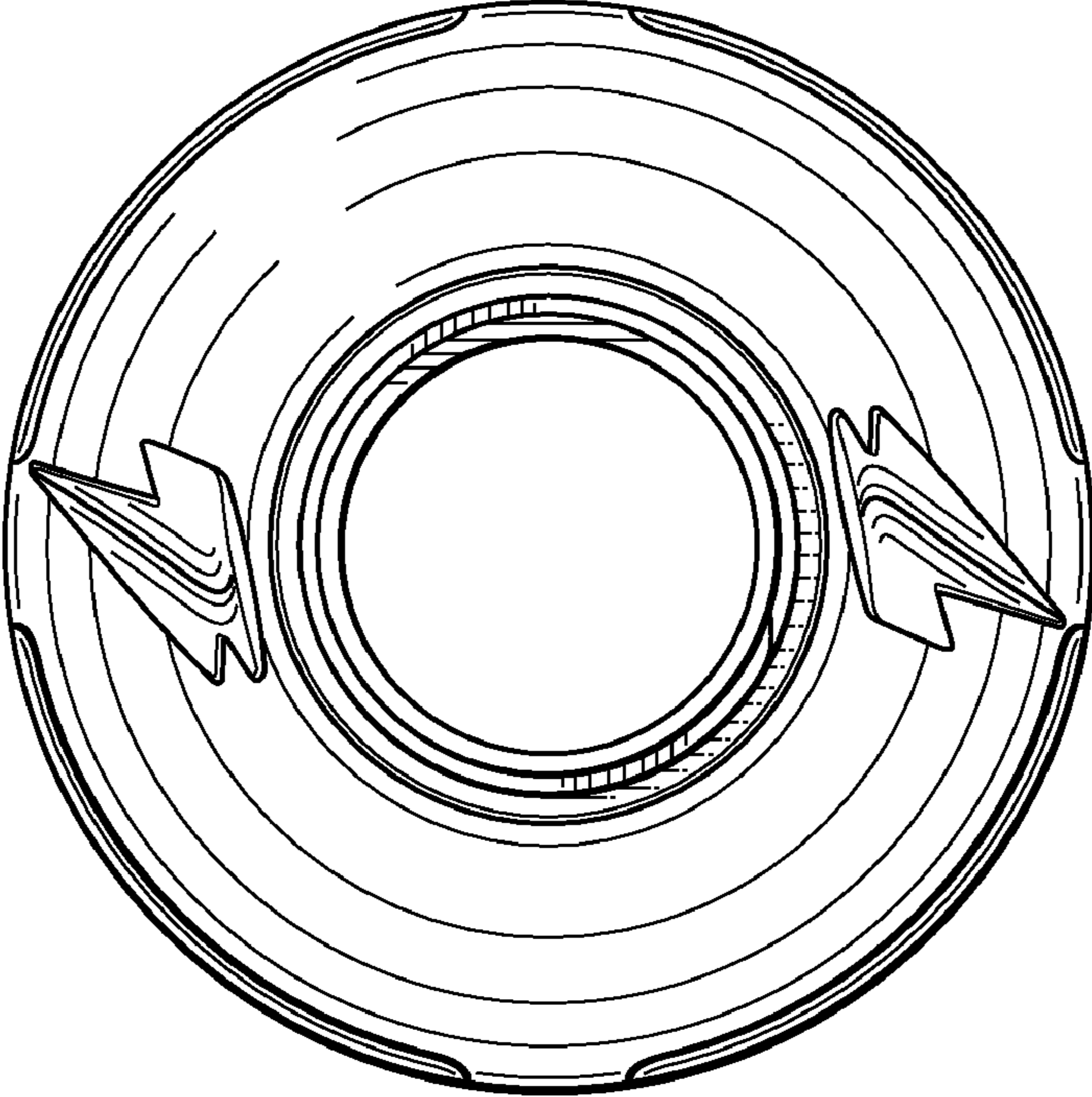

Fig. 12

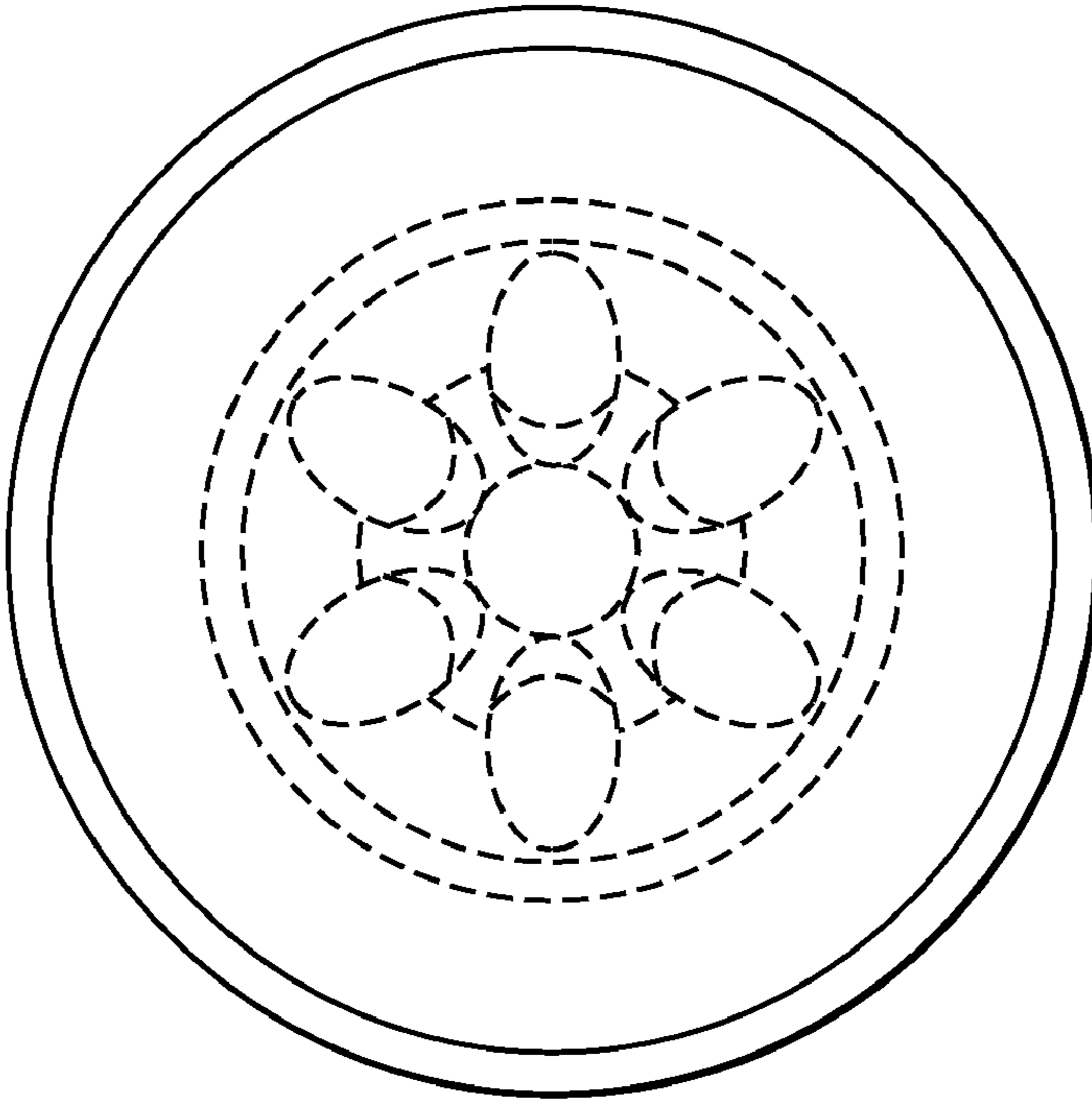

Fig. 13

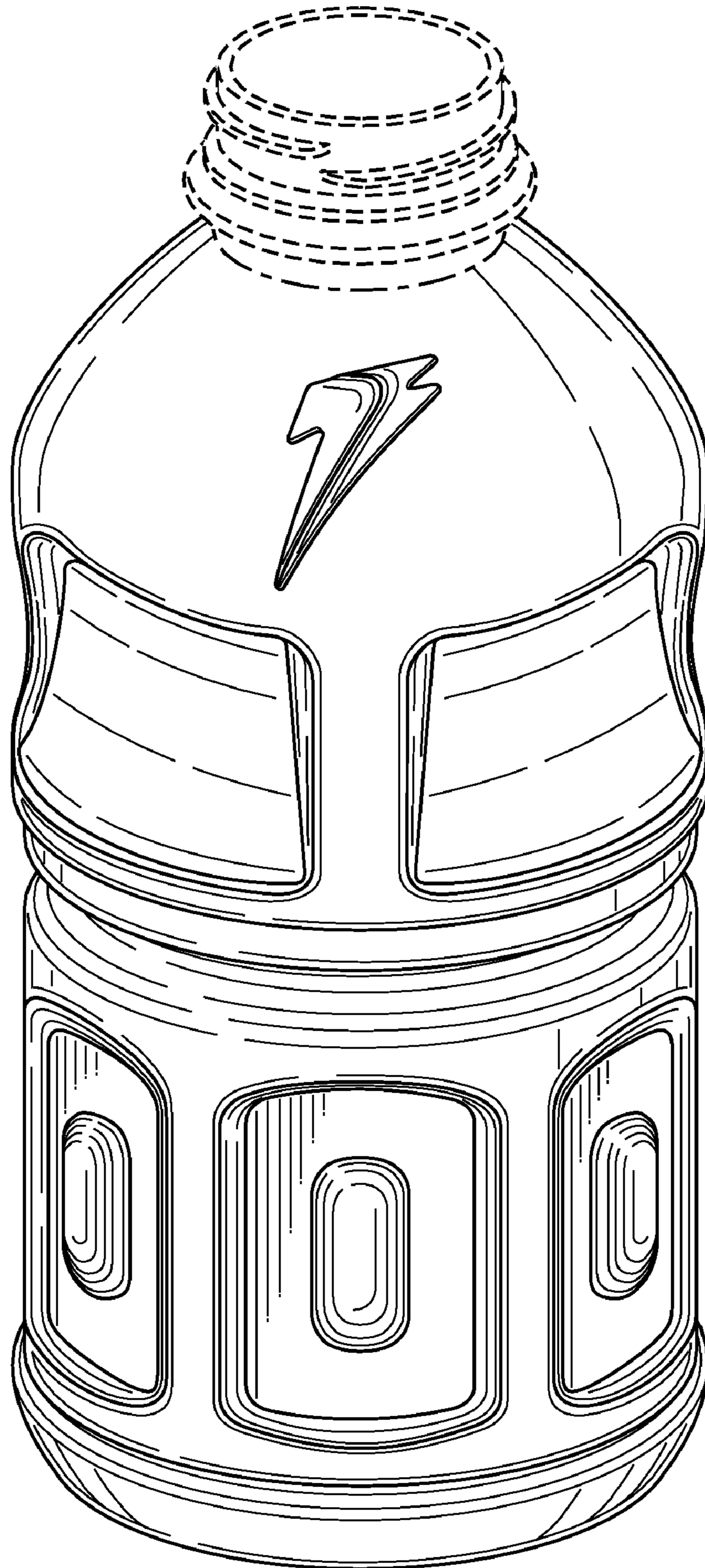

Fig. 14

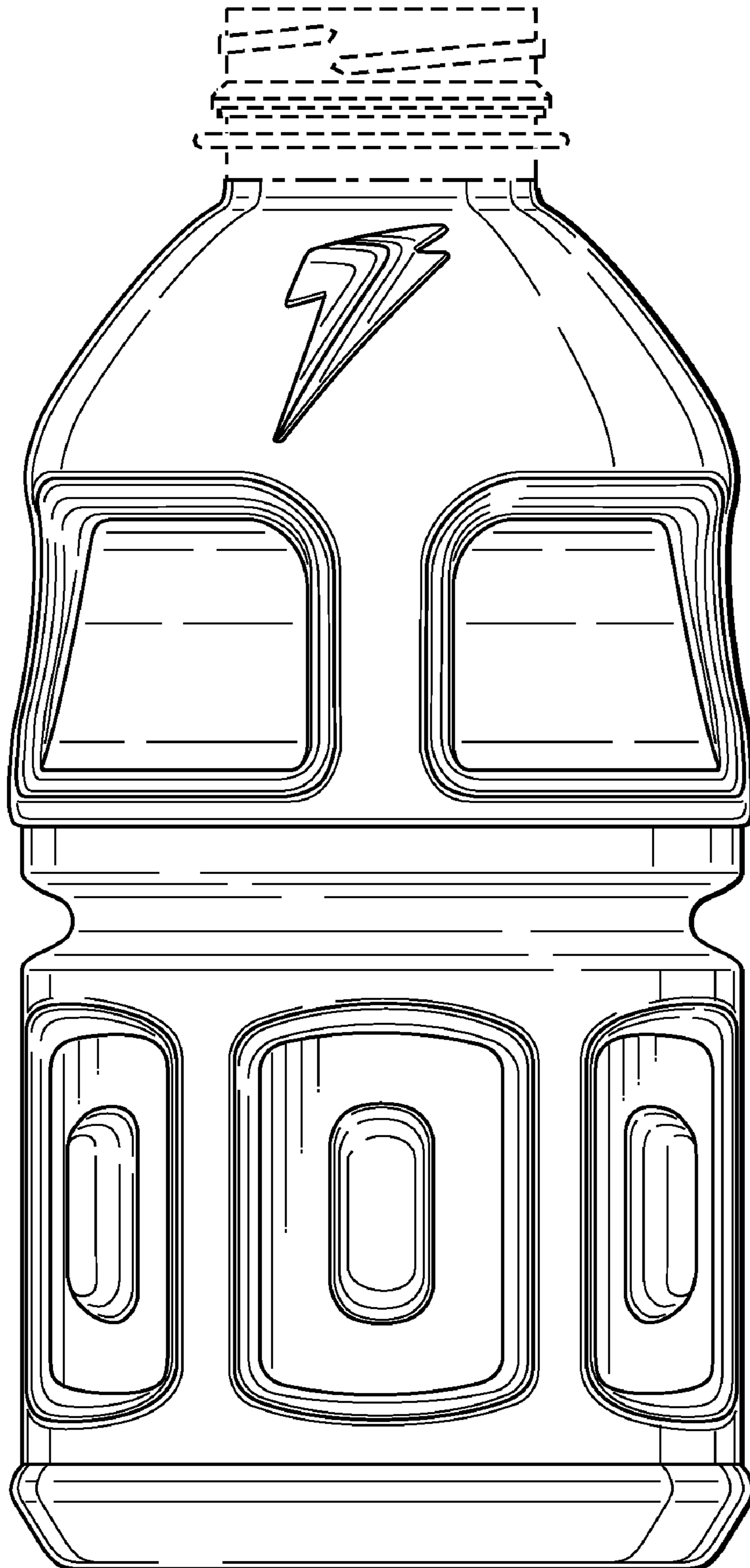

Fig. 15

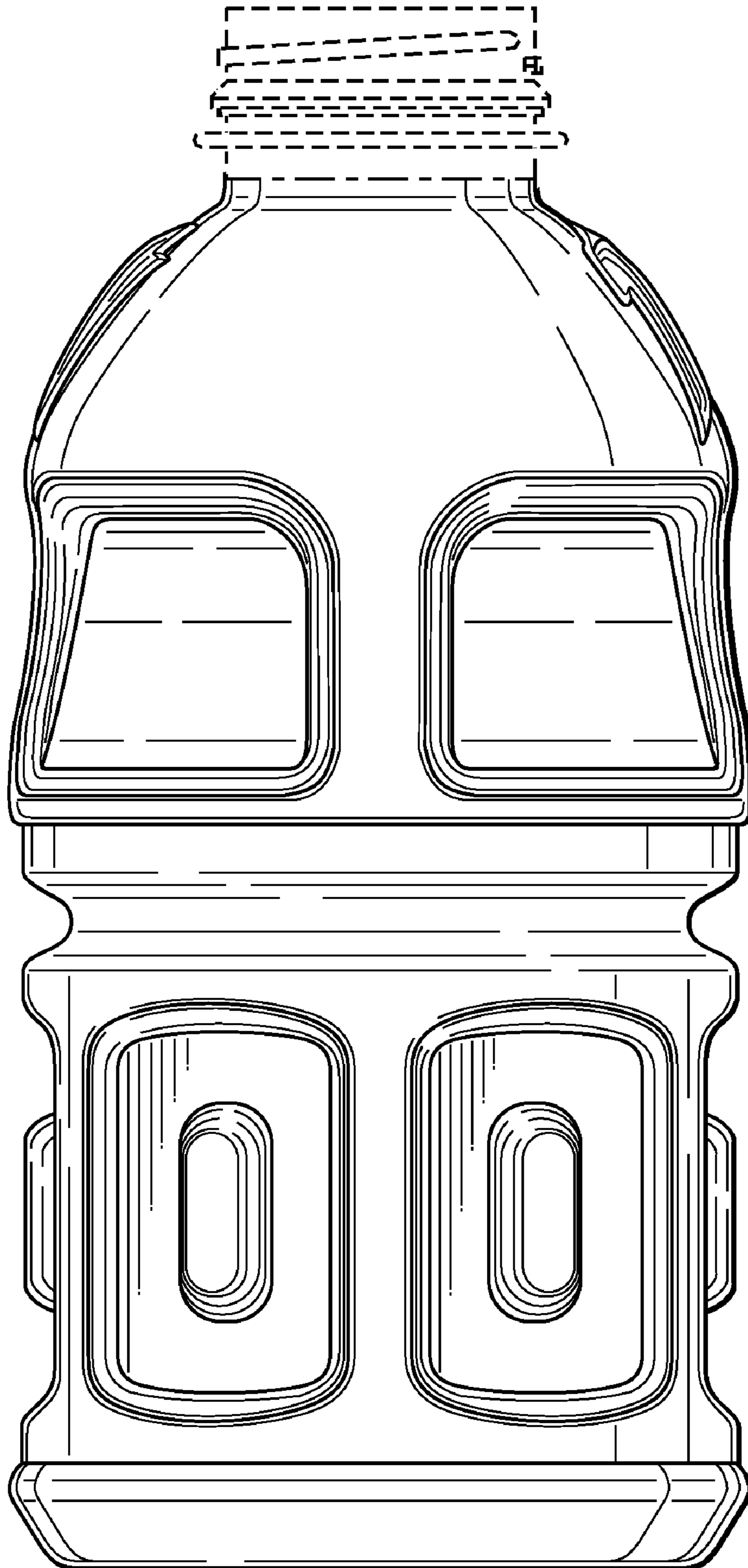

Fig. 16

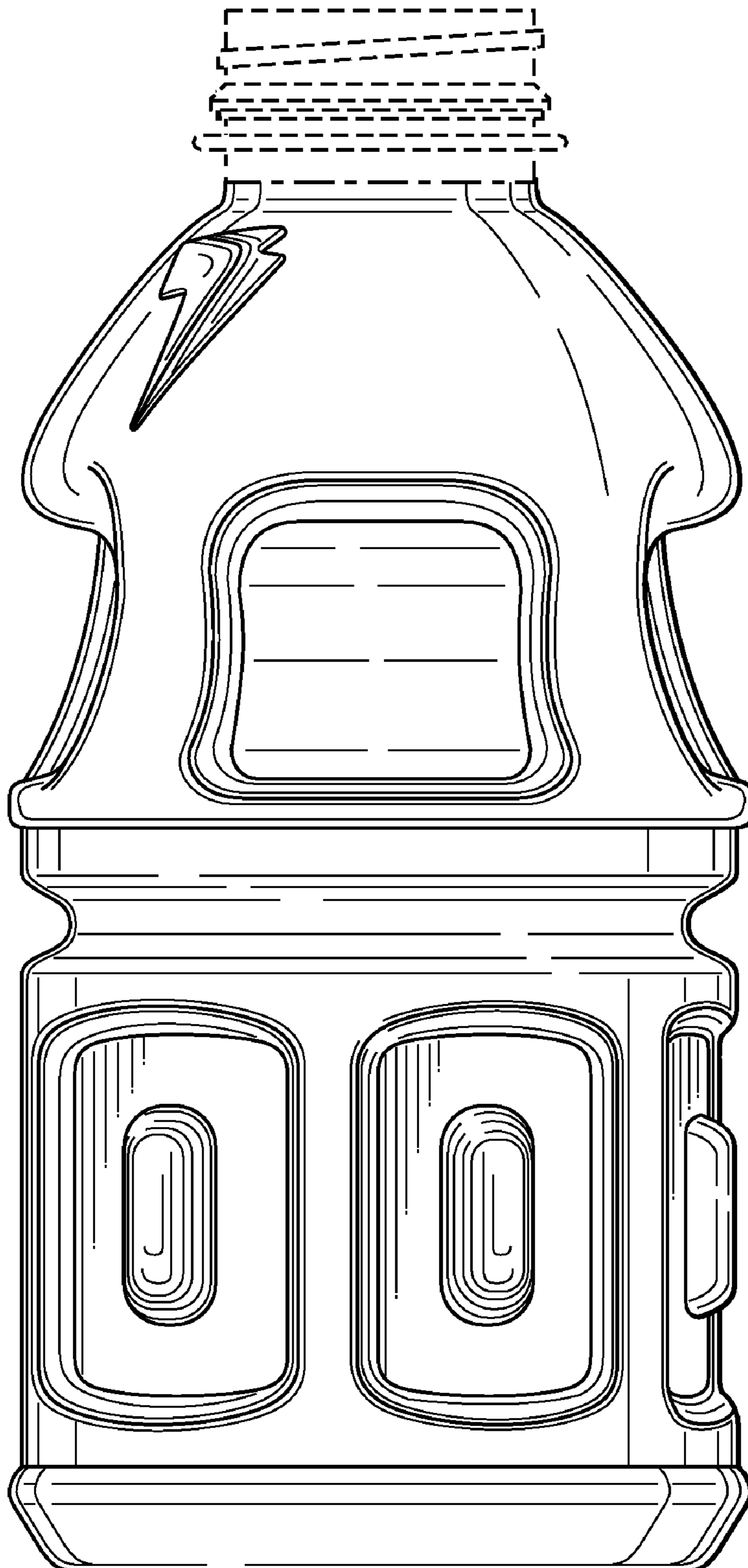

Fig. 17

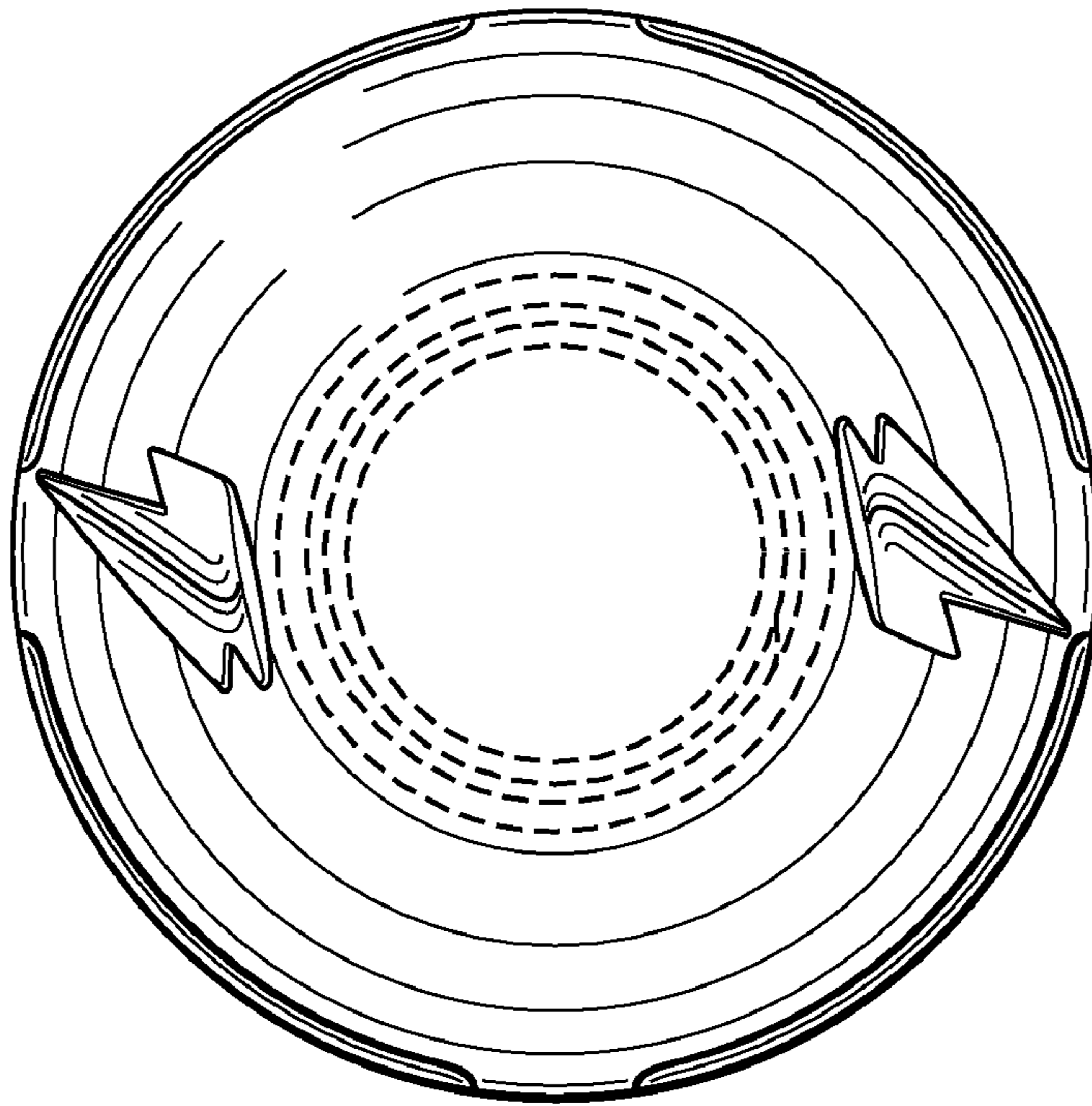

Fig. 18

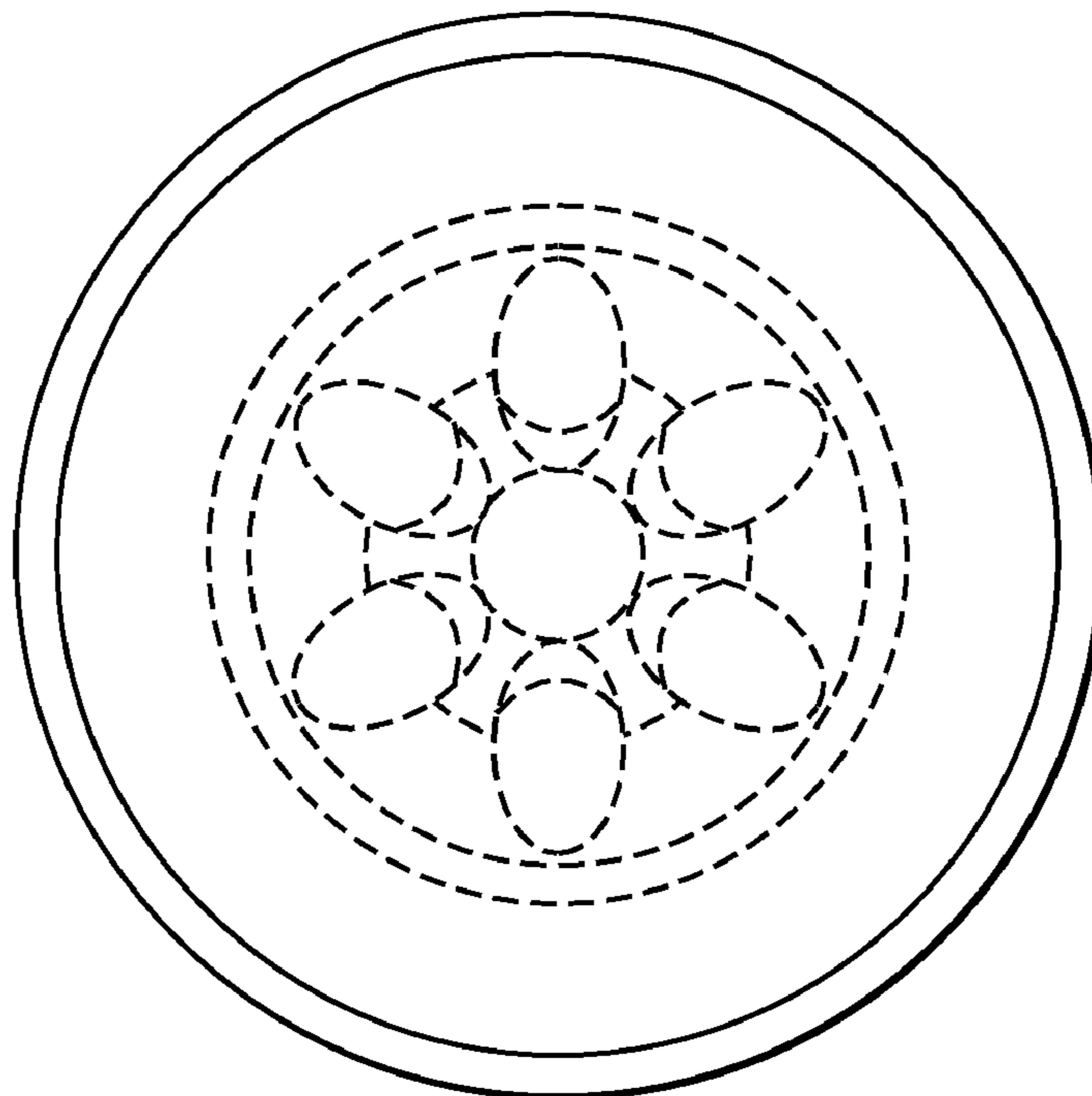

Fig. 19

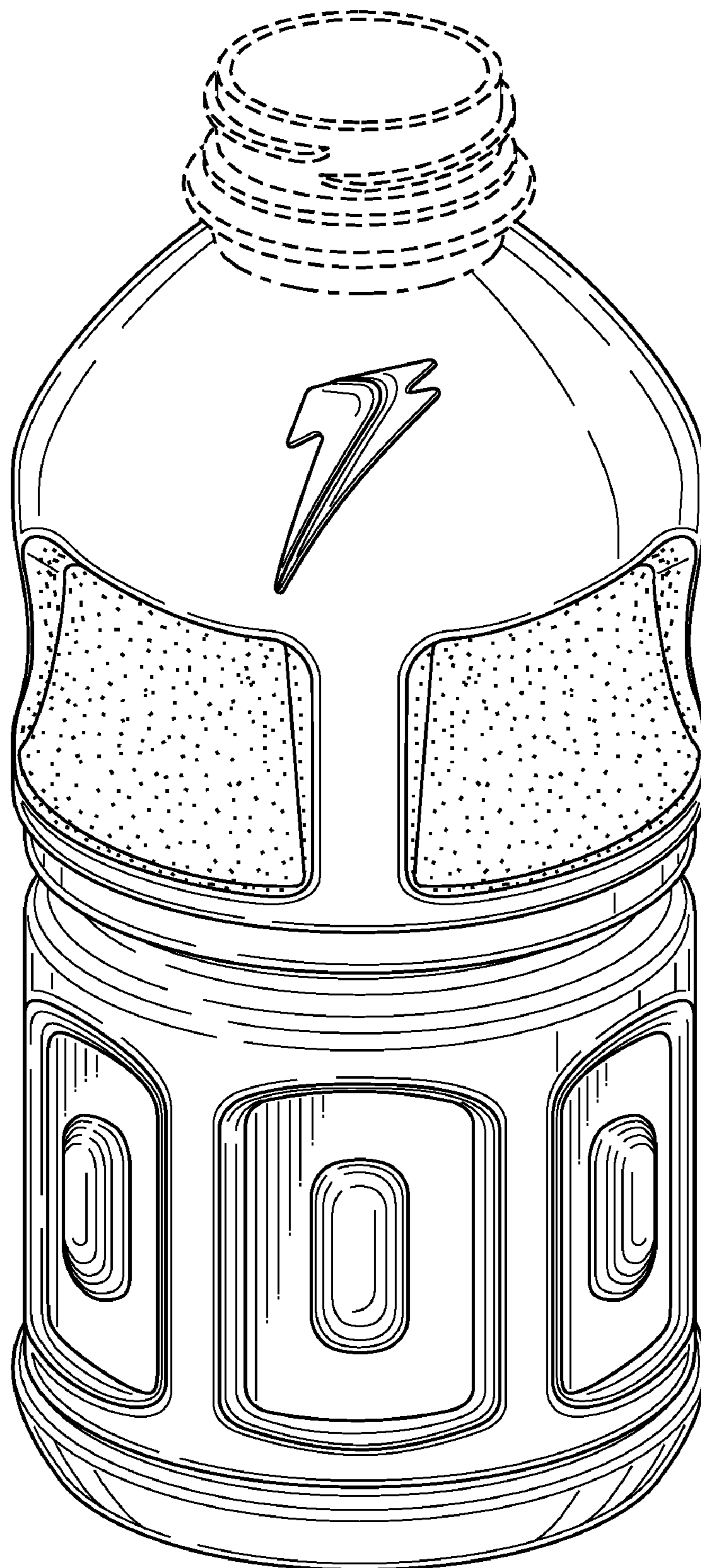

Fig. 20

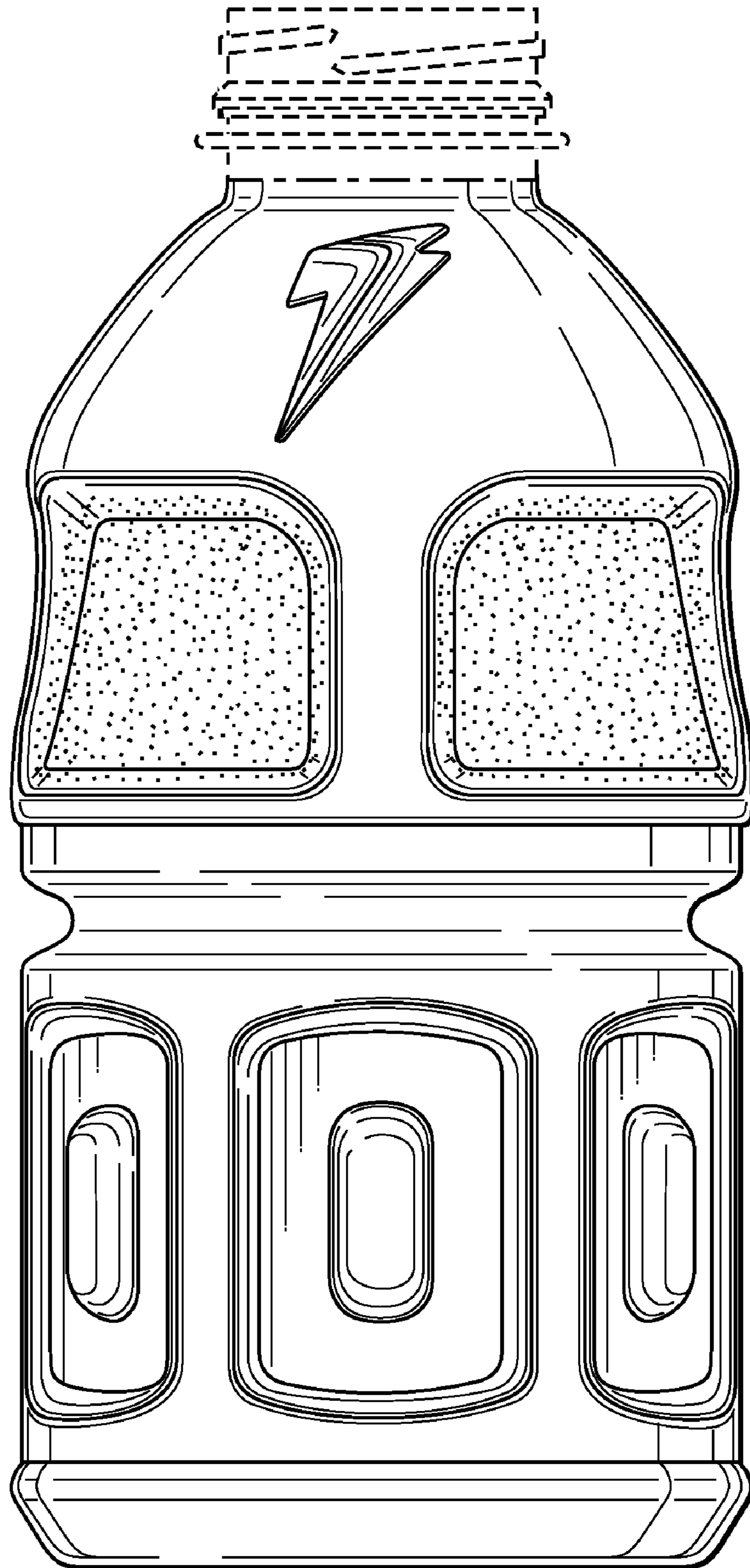

Fig. 21

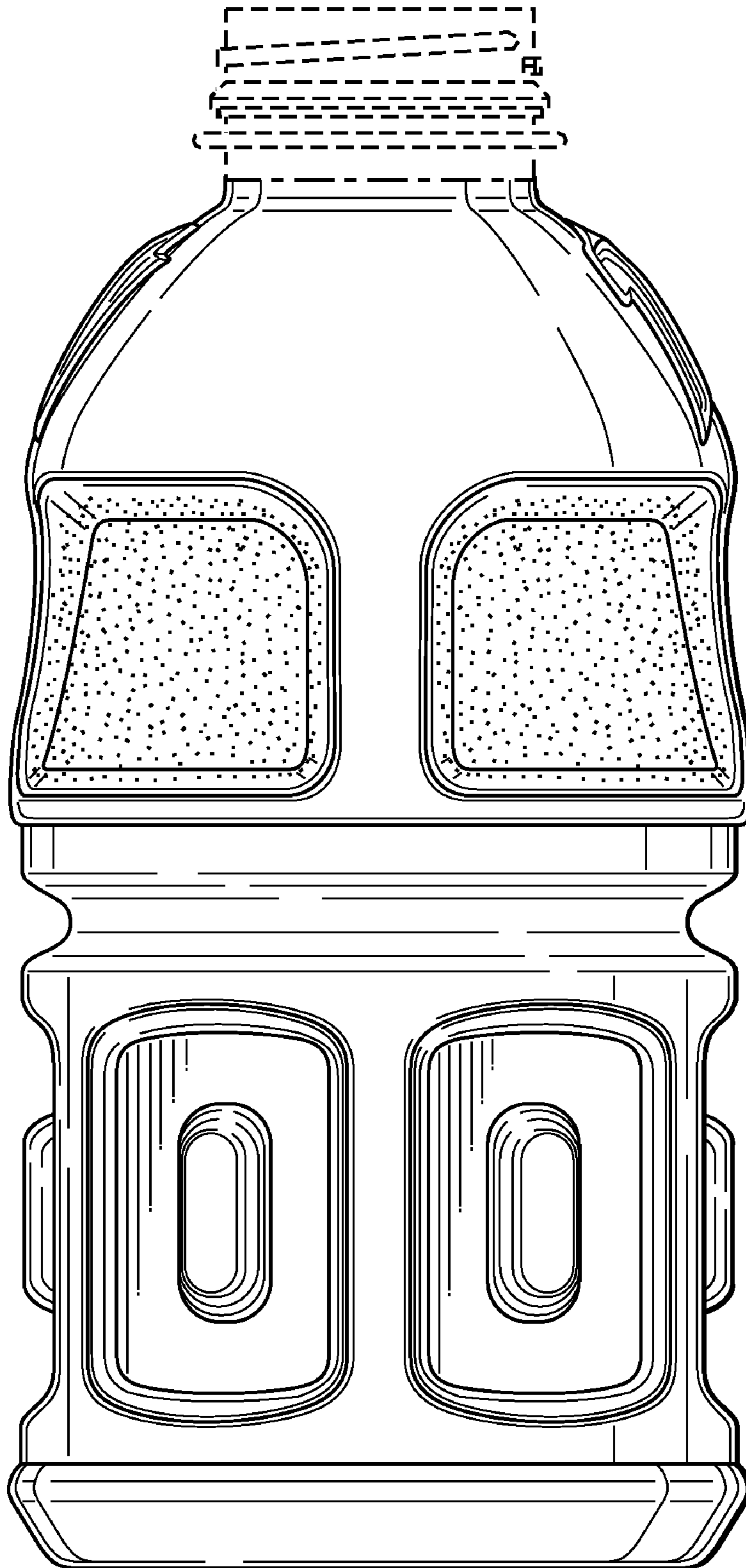

Fig. 22

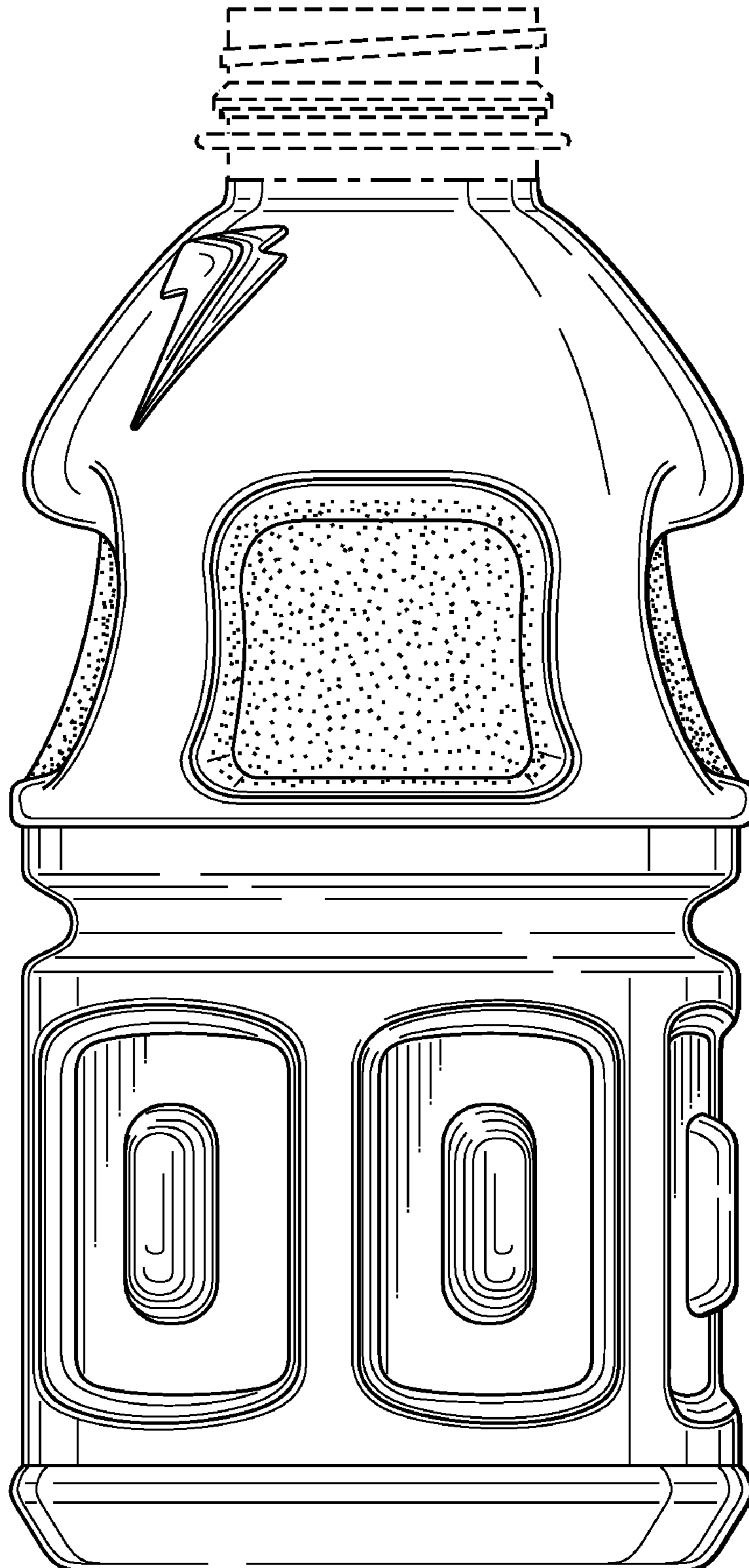

Fig. 23

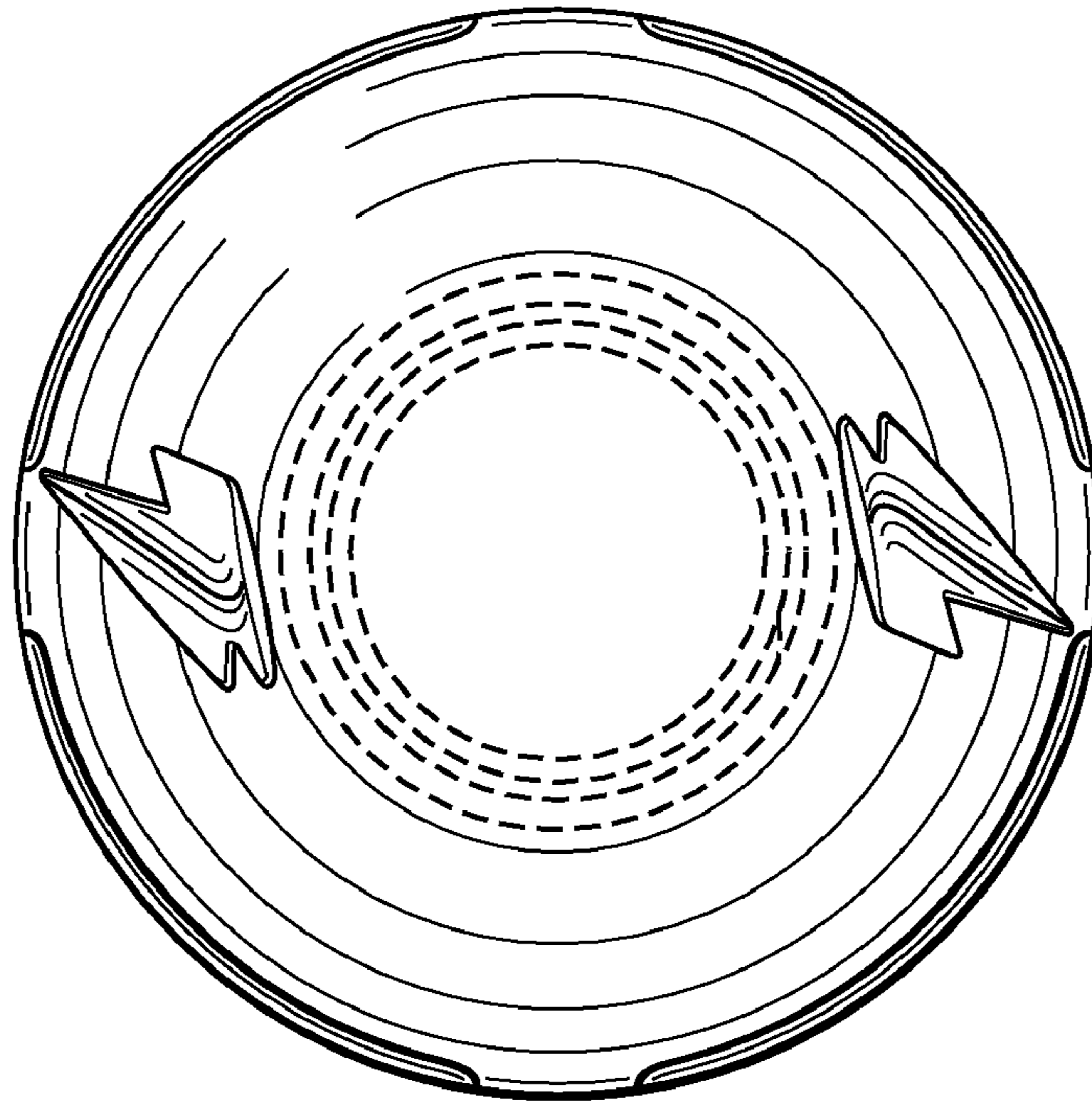

Fig. 24

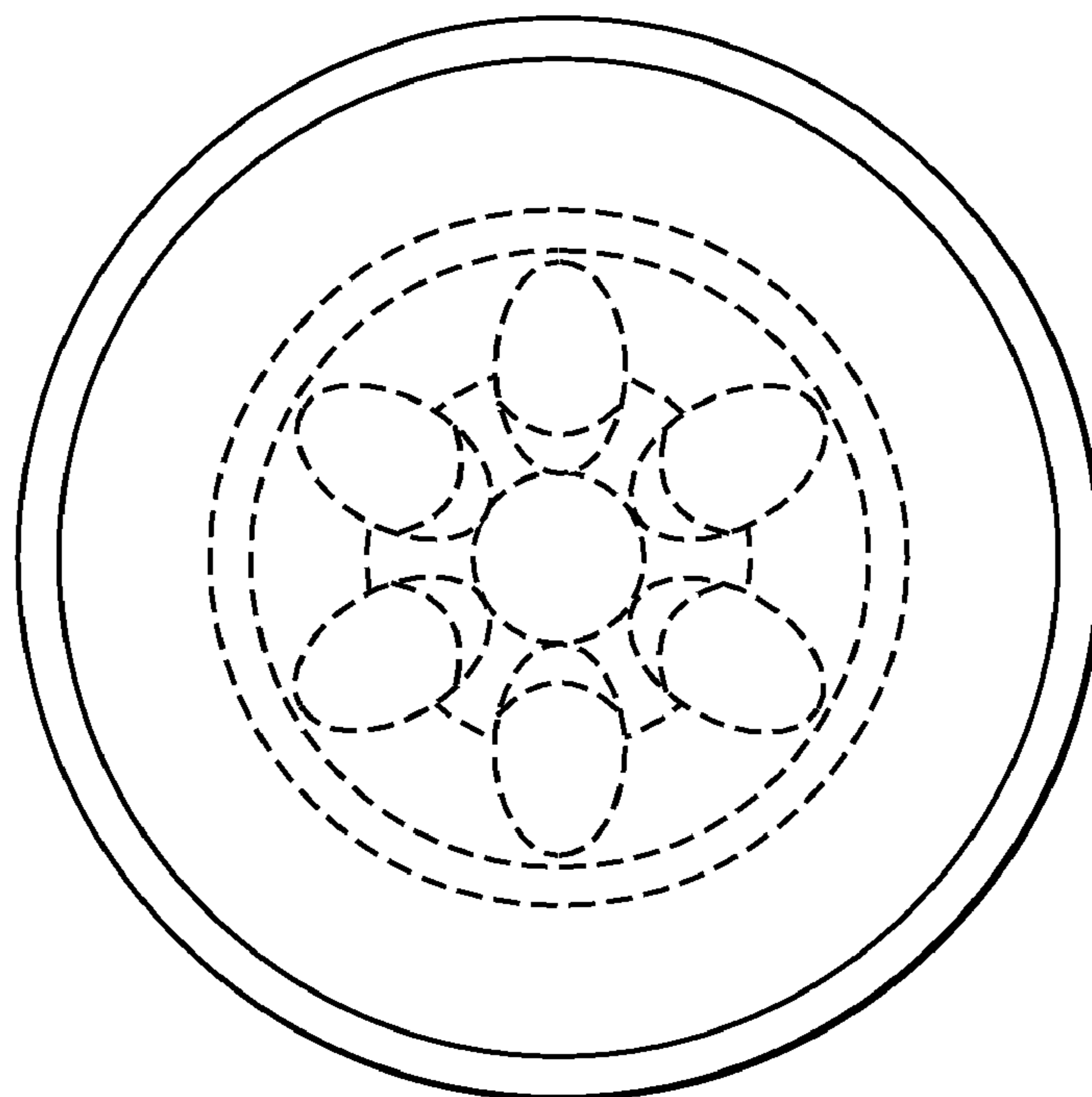

Fig. 25

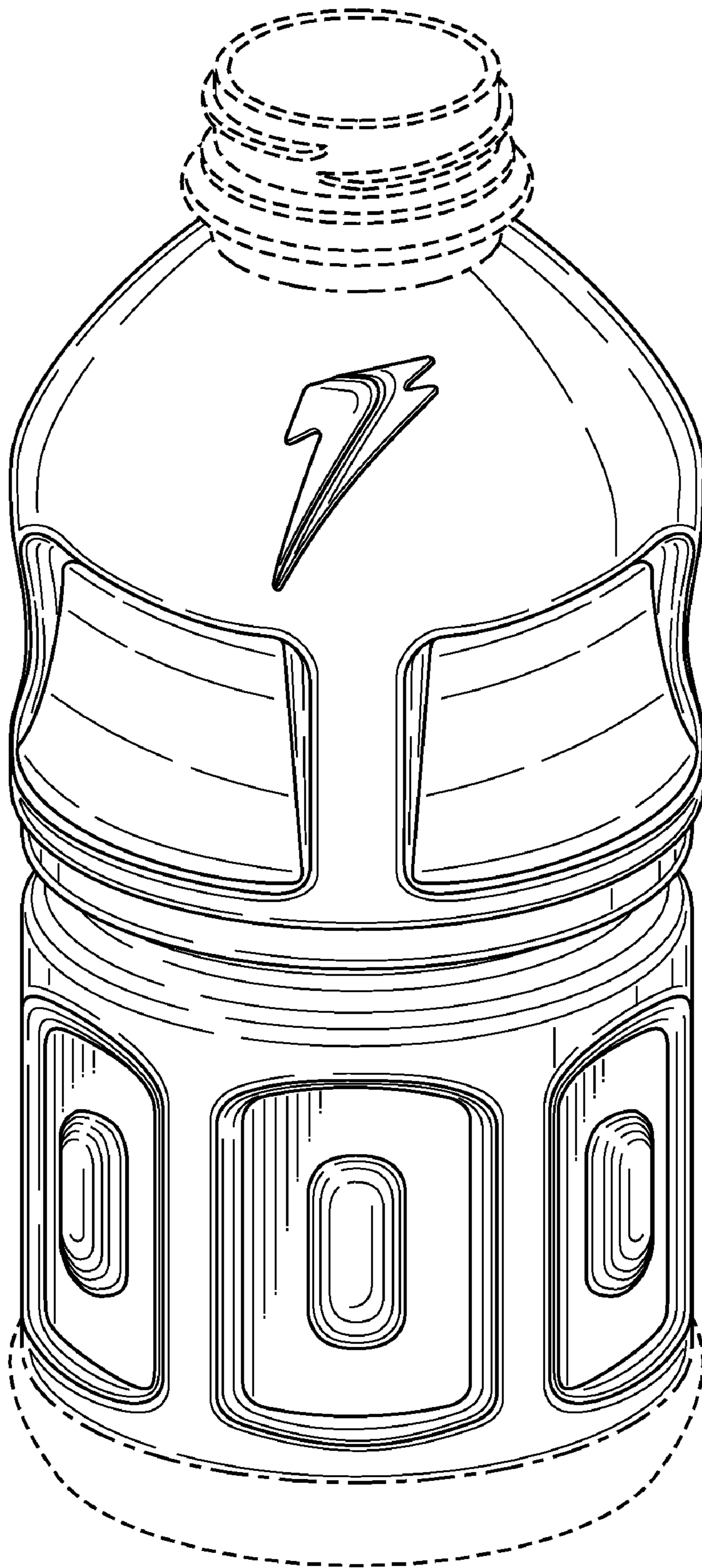

Fig. 26

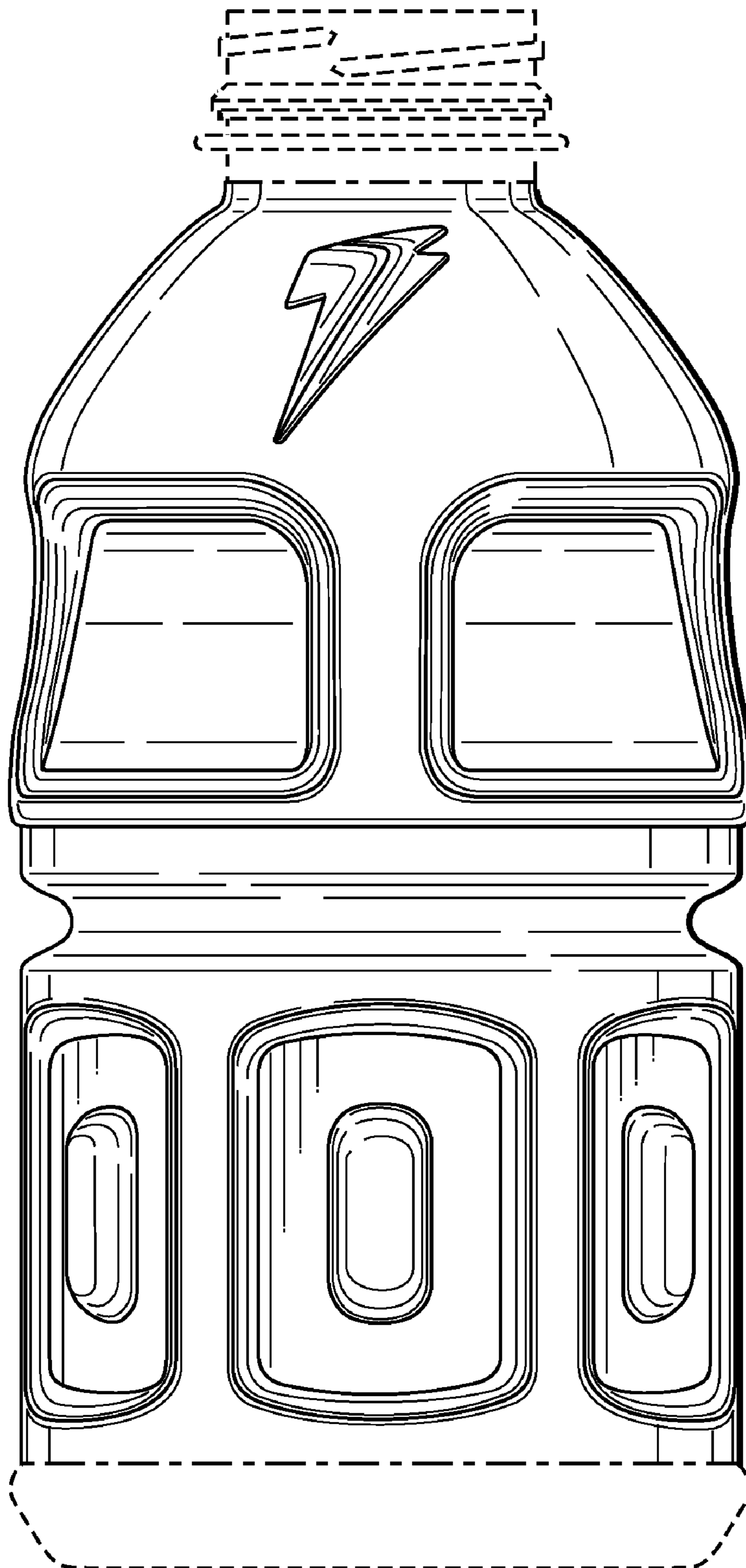

Fig. 27

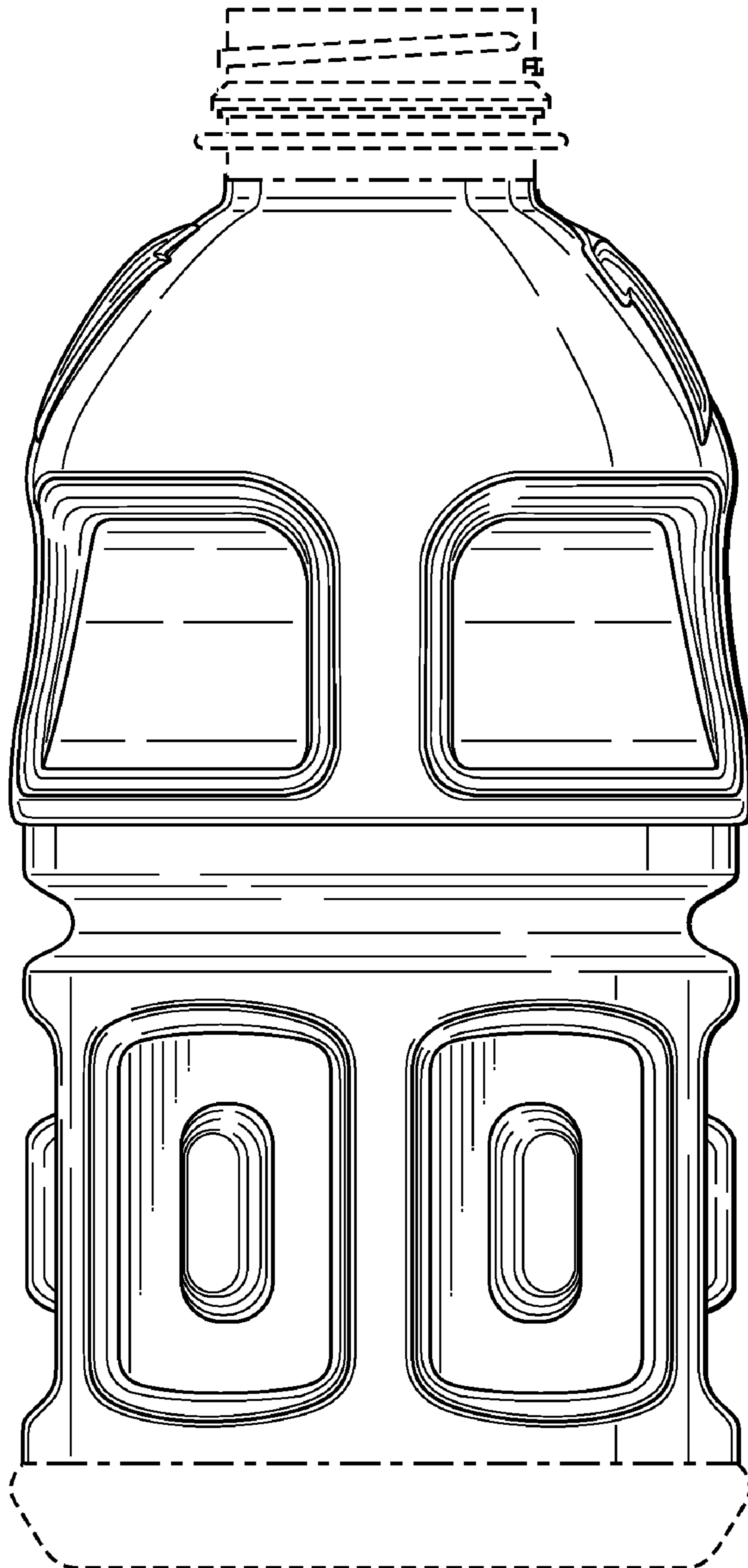

Fig. 28

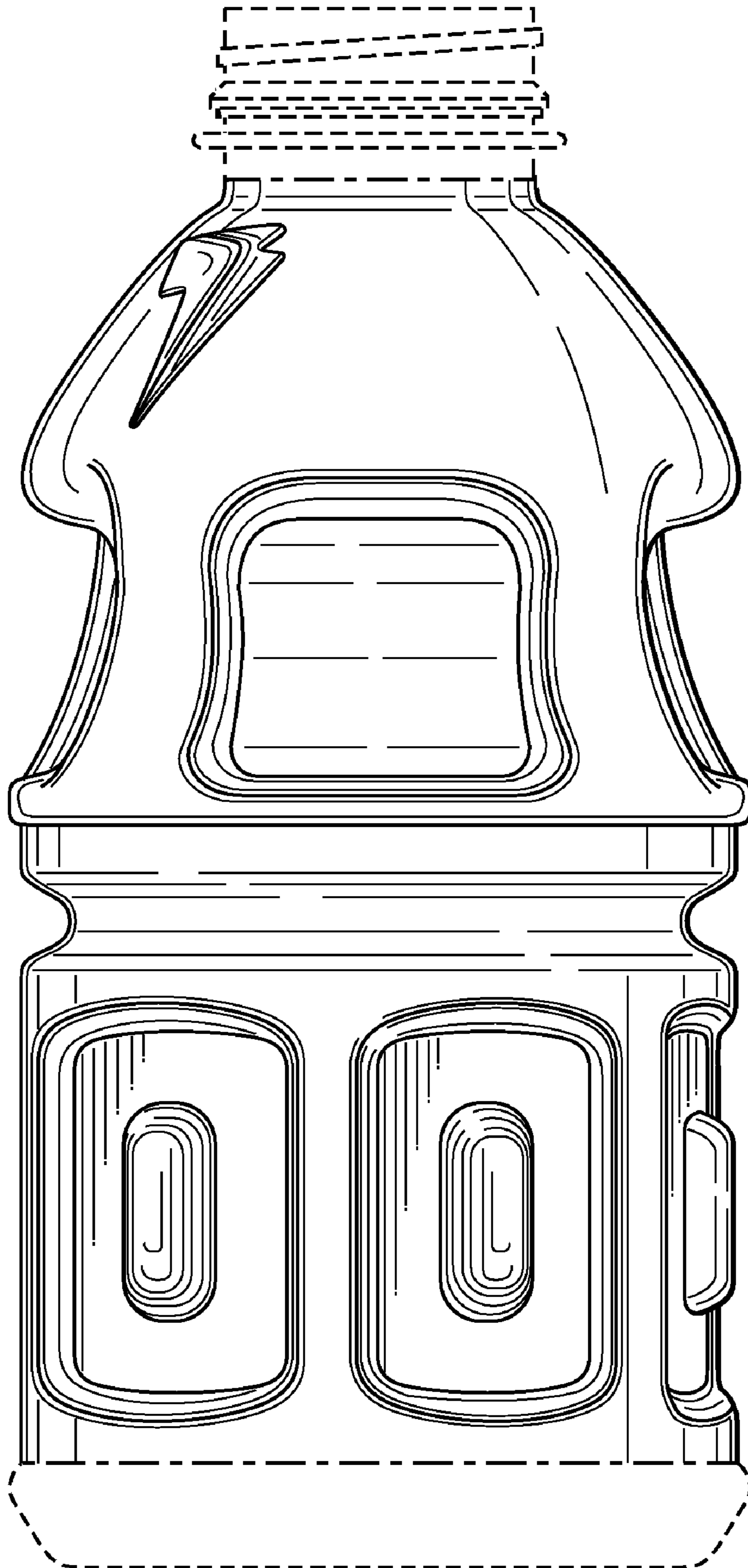

Fig. 29

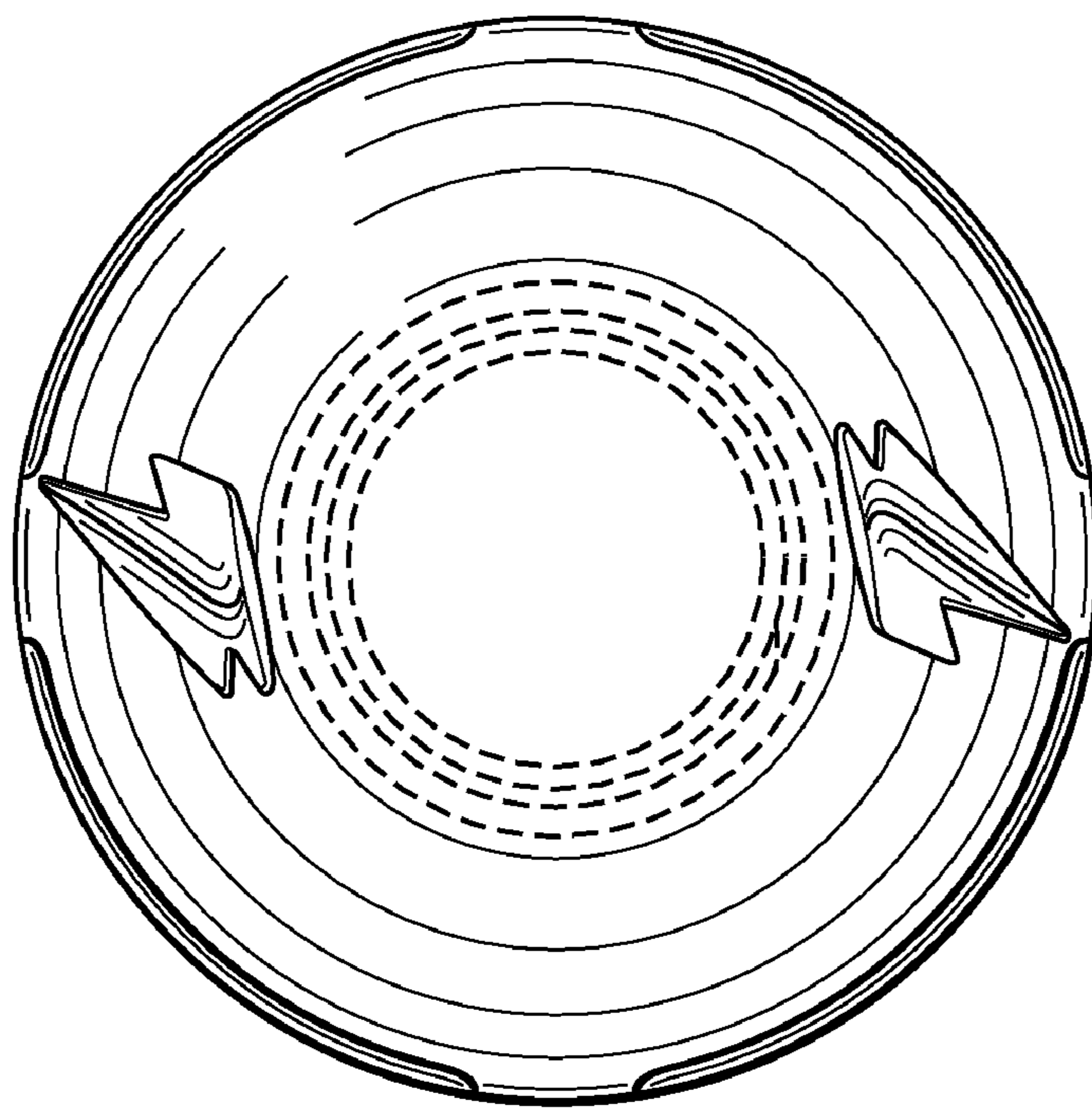

Fig. 30

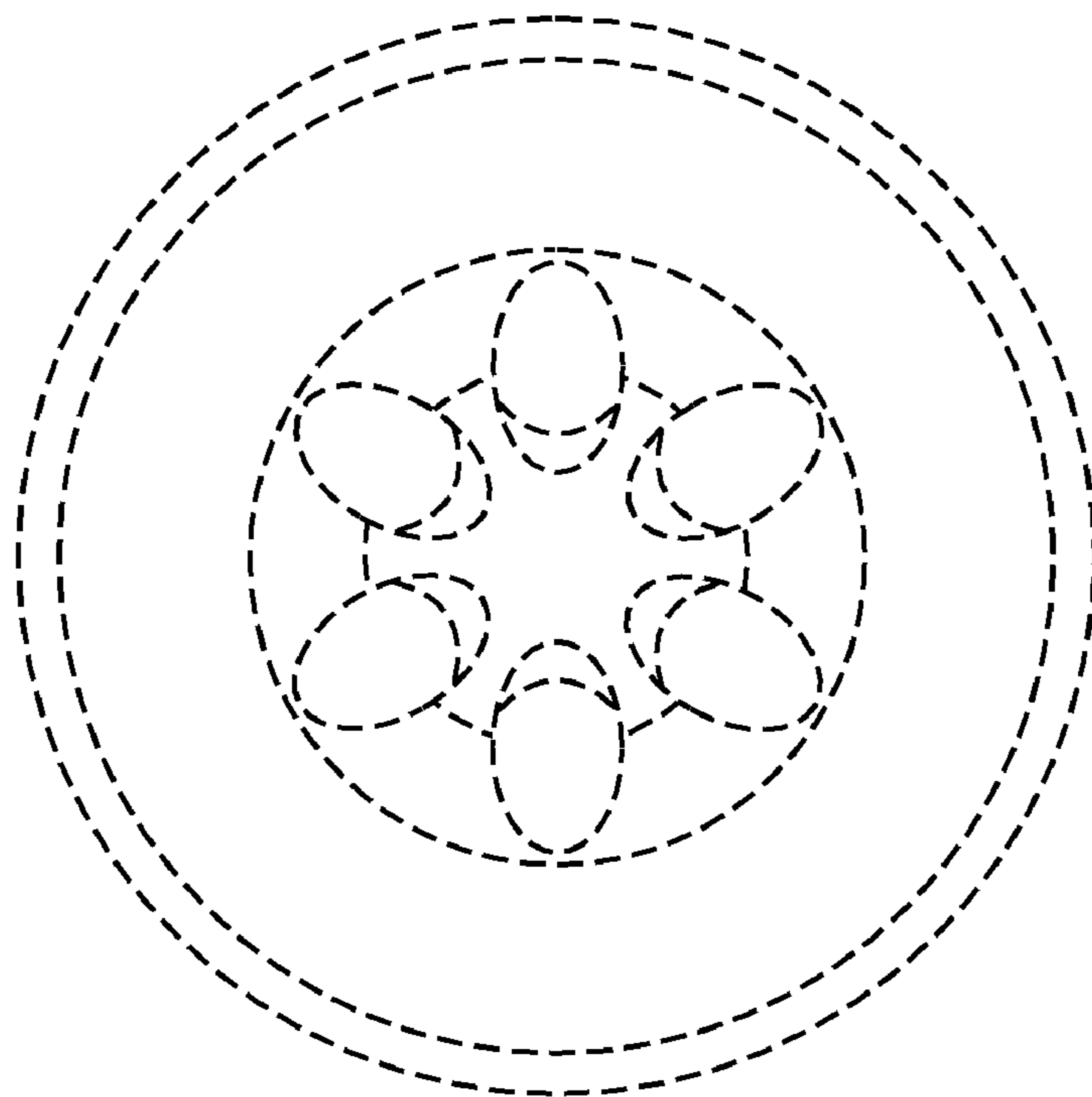

Fig. 31

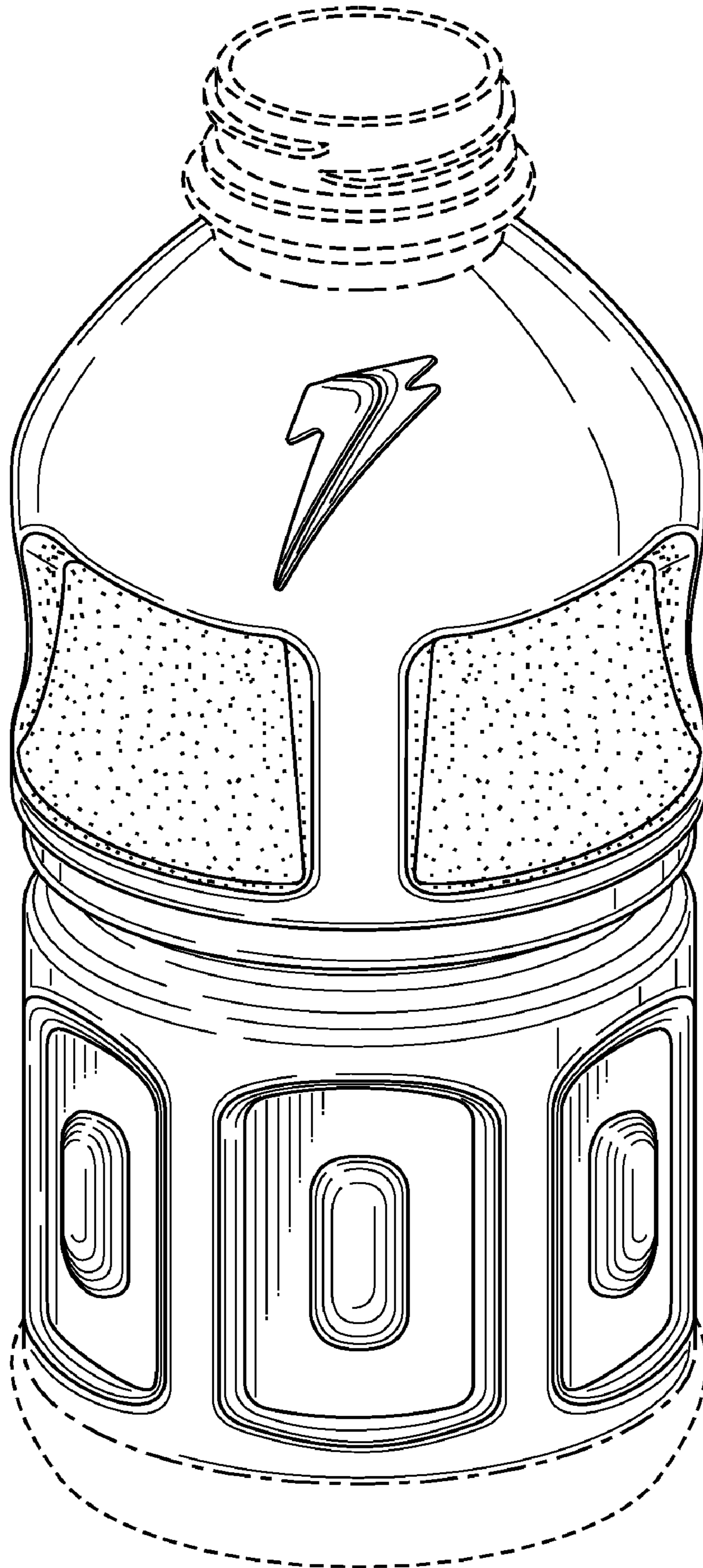

Fig. 32

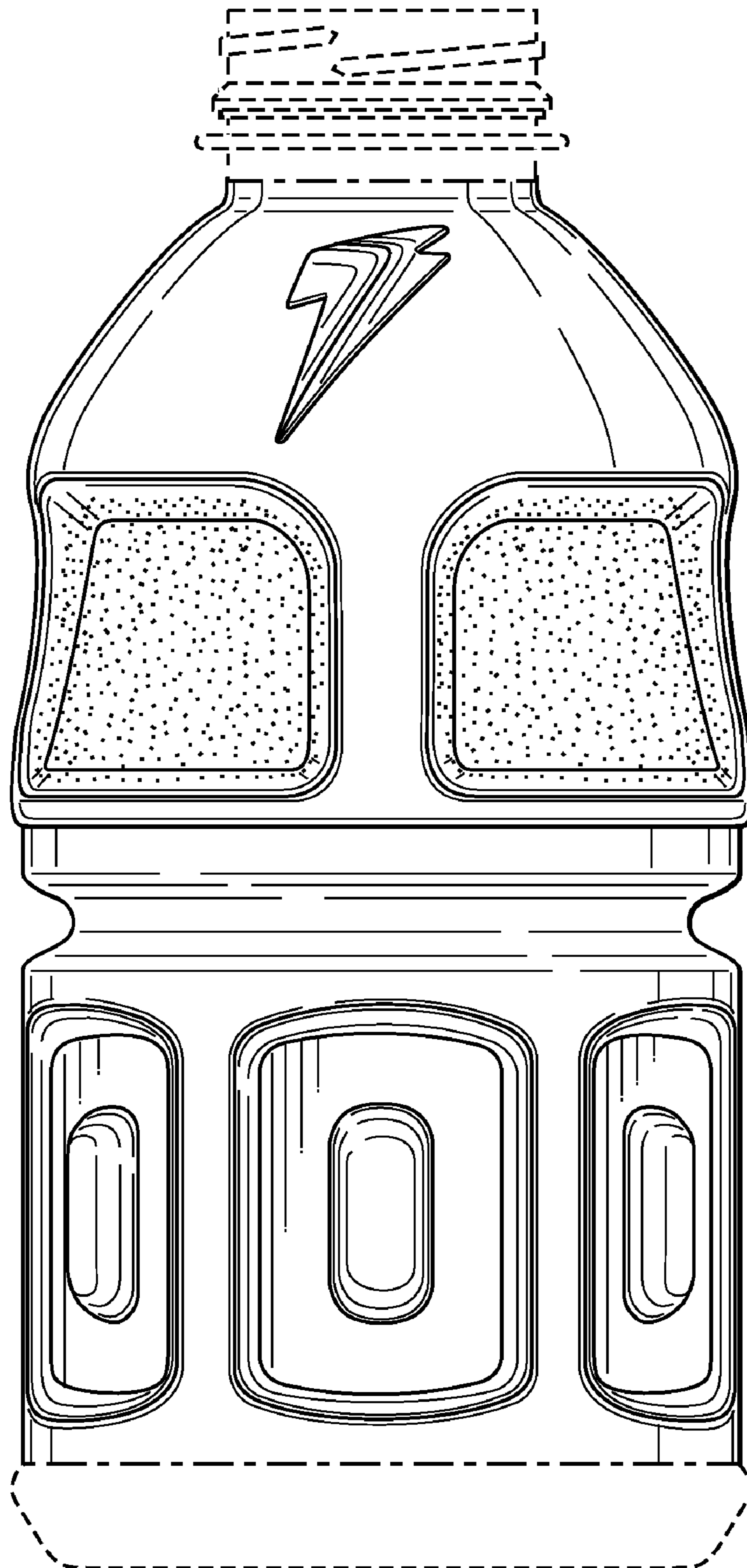

Fig. 33

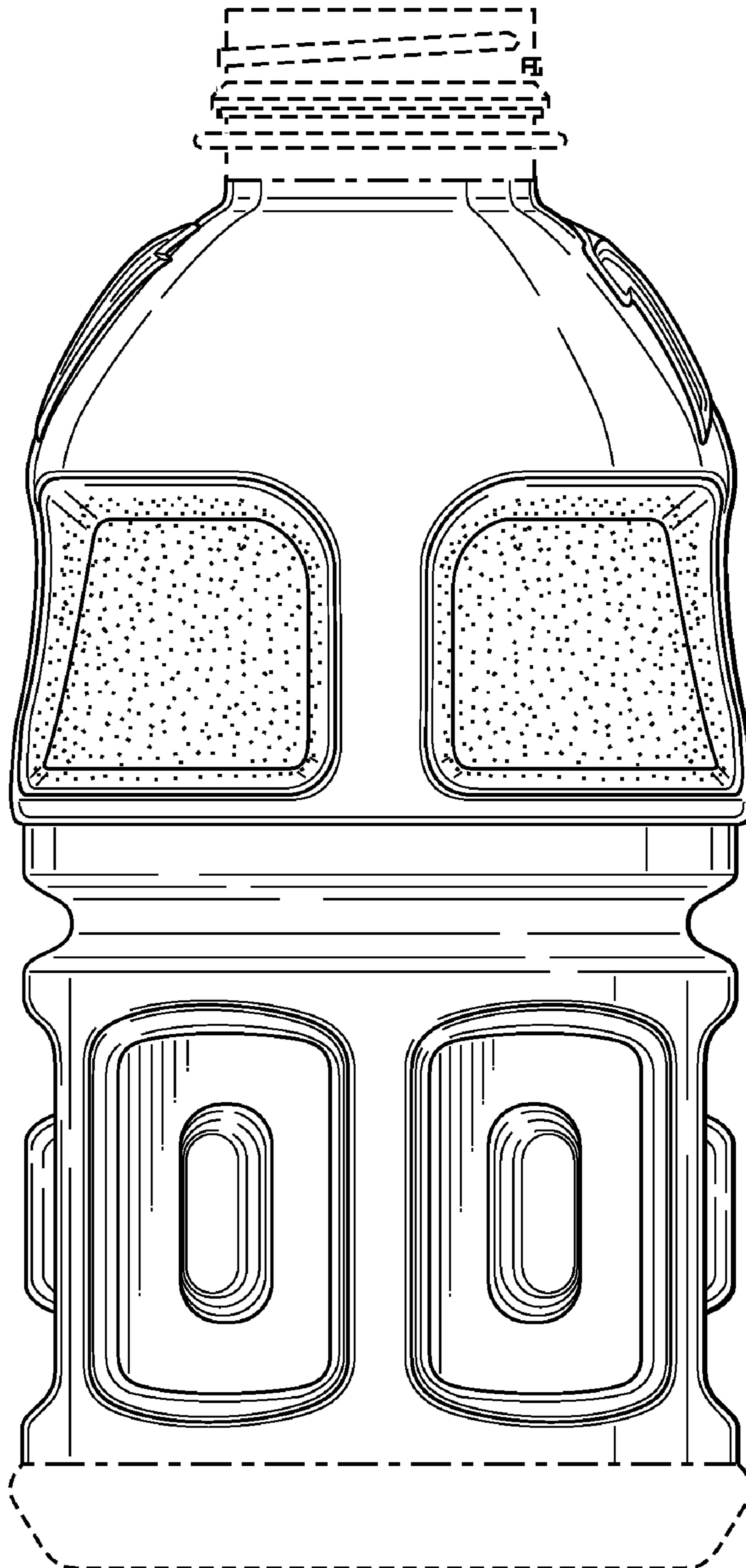

Fig. 34

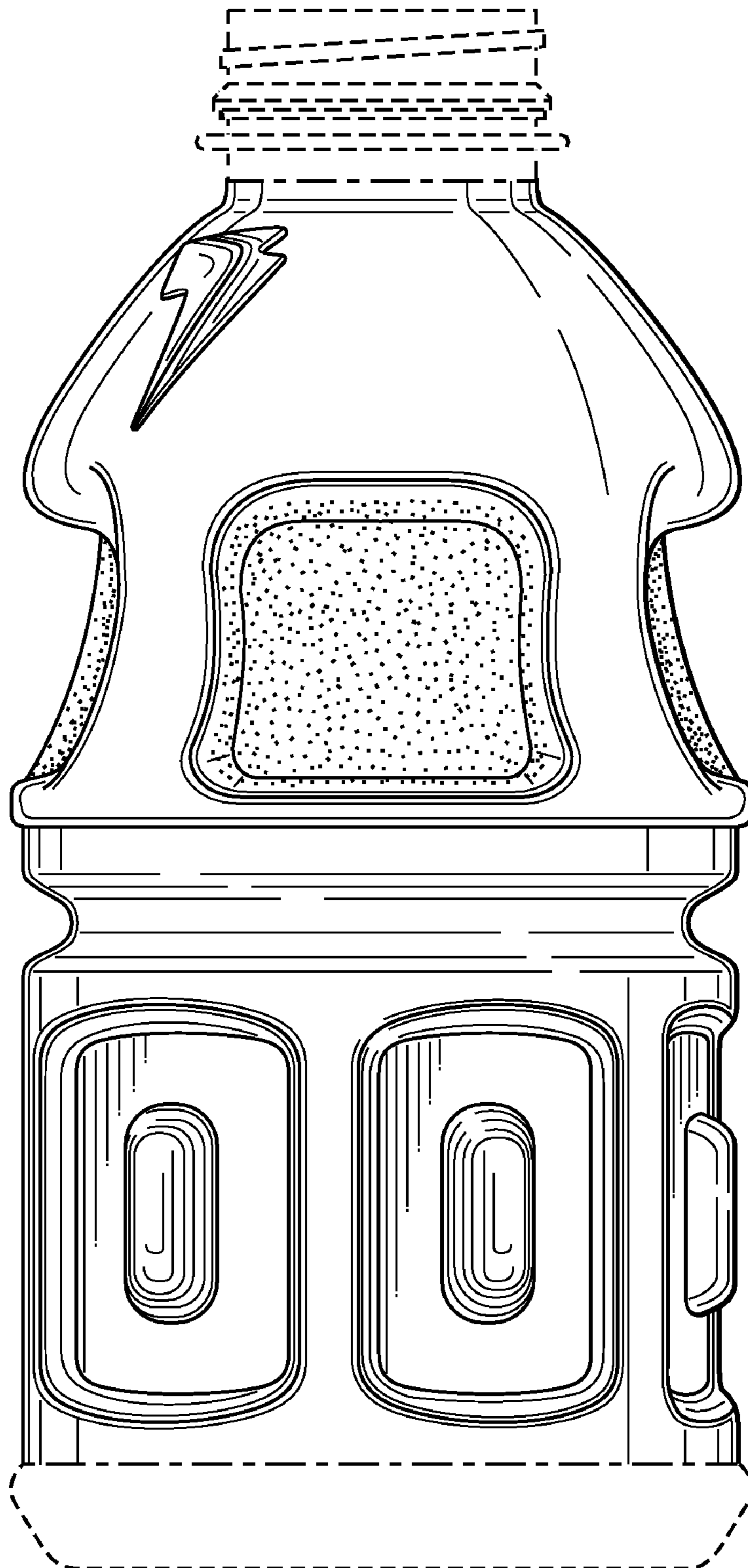

Fig. 35

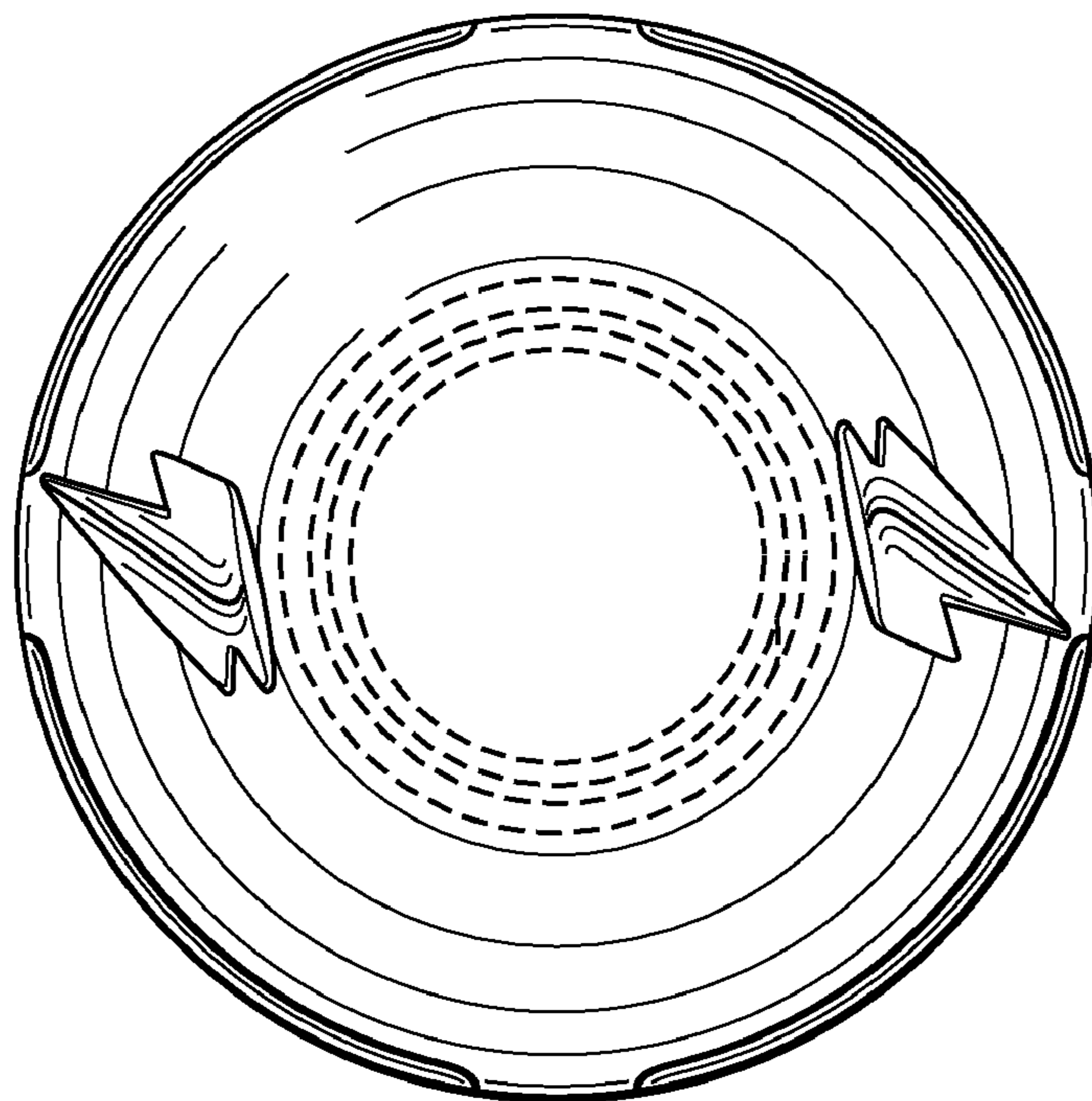

Fig. 36

