

US00D591526S

(12) **United States Design Patent**
Breen

(10) **Patent No.:** **US D591,526 S**

(45) **Date of Patent:** **** May 5, 2009**

(54) **CHAIR**

(75) Inventor: **William R. Breen**, Mississauga (CA)

(73) Assignee: **Nightingale Corp.**, Mississauga, Ontario (CA)

(**) Term: **14 Years**

(21) Appl. No.: **29/309,506**

(22) Filed: **Aug. 25, 2008**

(30) **Foreign Application Priority Data**

Jun. 4, 2008 (CA) 126281

(51) **LOC (9) Cl.** **06-01**

(52) **U.S. Cl.** **D6/379**

(58) **Field of Classification Search** D6/334–336,
D6/369, 371–373, 374, 375, 376, 379, 380,
D6/499, 500–502; 297/239, 411.42, 411.43,
297/445.1, 446.1, 451.13, 452.13, 452.46,
297/452.64

See application file for complete search history.

(56) **References Cited**

U.S. PATENT DOCUMENTS

D513,457 S * 1/2006 Asano et al. D6/380
D519,294 S * 4/2006 Frenkler et al. D6/375
D520,769 S * 5/2006 Bennett et al. D6/379
D540,559 S * 4/2007 Neil D6/379
D544,235 S * 6/2007 Chen D6/379
D547,963 S * 8/2007 Olano D6/379
D548,477 S * 8/2007 Olano D6/379
D566,413 S * 4/2008 Huang D6/379
D575,542 S * 8/2008 Igarashi D6/380

D579,226 S * 10/2008 Pinaffo et al. D6/379
D581,180 S * 11/2008 Chi D6/380

* cited by examiner

Primary Examiner—Mimosa De

(57) **CLAIM**

I claim the ornamental design for a chair, as shown.

DESCRIPTION

FIG. 1 is a perspective view of a first embodiment showing my new design;

FIG. 2 is a right-side elevational view thereof;

FIG. 3 is a front elevational view thereof;

FIG. 4 is a left-side elevational view thereof;

FIG. 5 is a rear elevational view thereof;

FIG. 6 is a top view thereof;

FIG. 7 is a bottom view thereof;

FIG. 8 is a perspective view of a second embodiment of my design shown in FIG. 1;

FIG. 9 is the right side elevational view of the second embodiment;

FIG. 10 is a front elevational view of the second embodiment;

FIG. 11 is a left side elevational view of the second embodiment;

FIG. 12 is a rear view of the second embodiment;

FIG. 13 is a top view of the second embodiment; and,

FIG. 14 is a bottom view of the second embodiment.

1 Claim, 8 Drawing Sheets

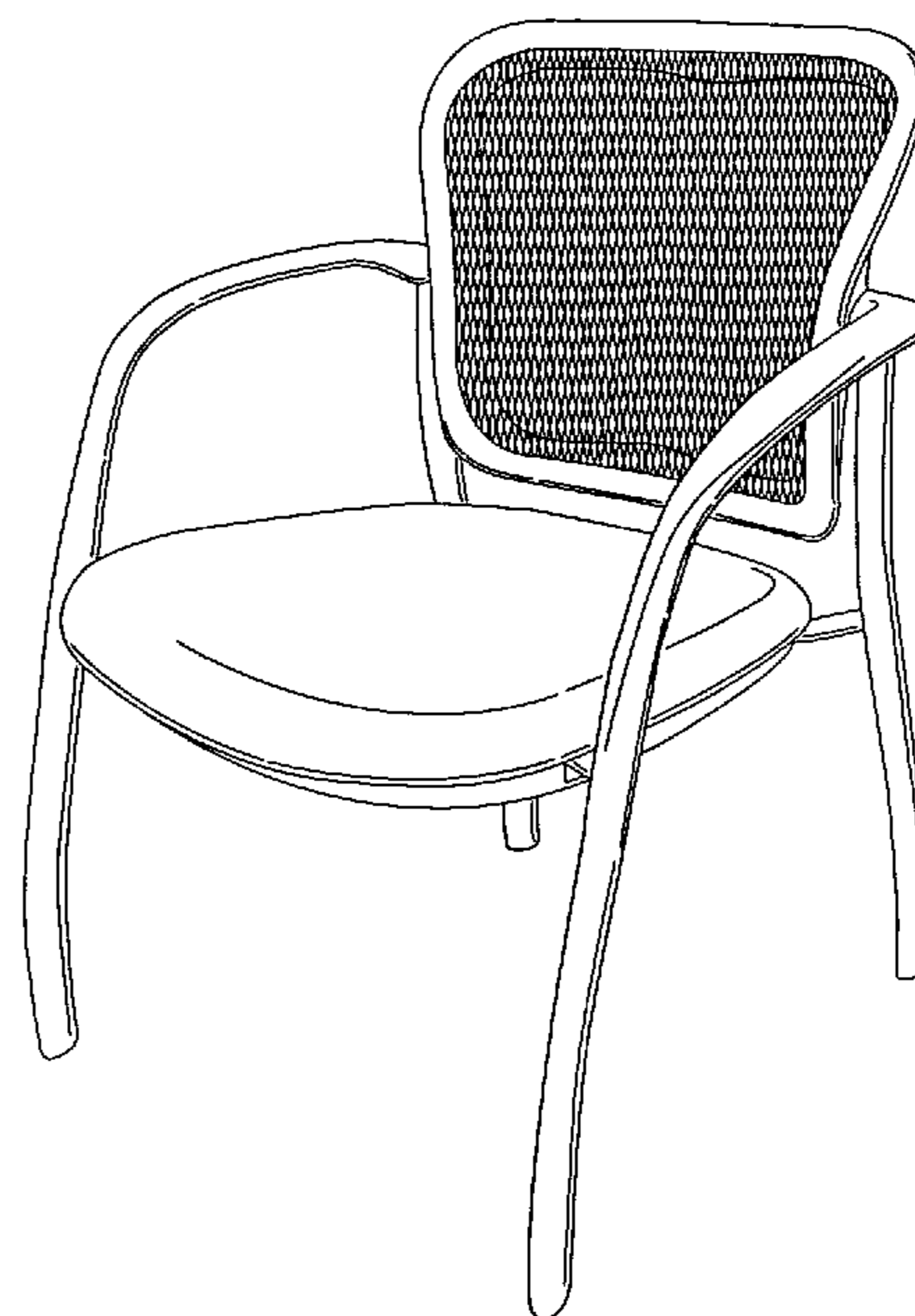
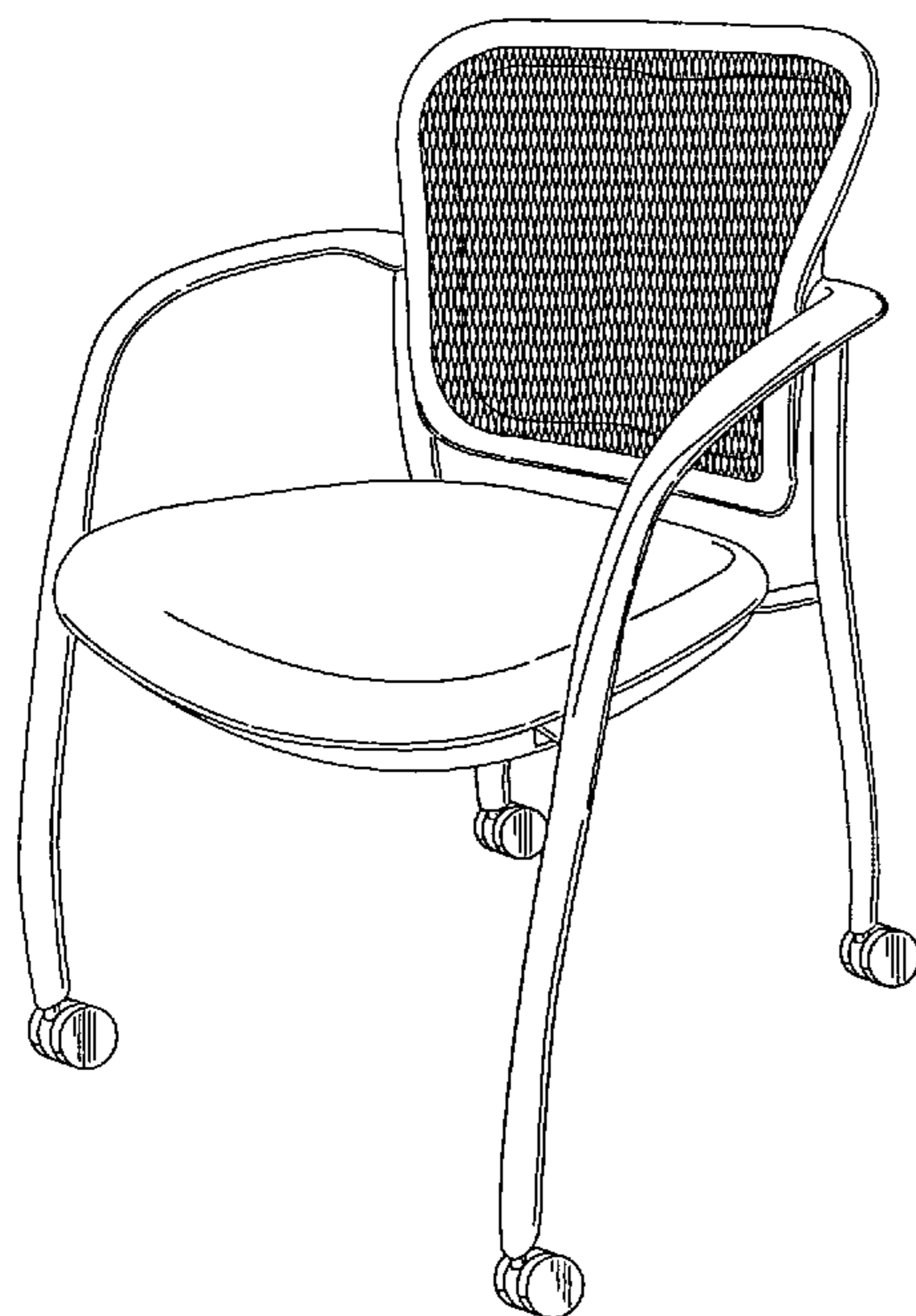

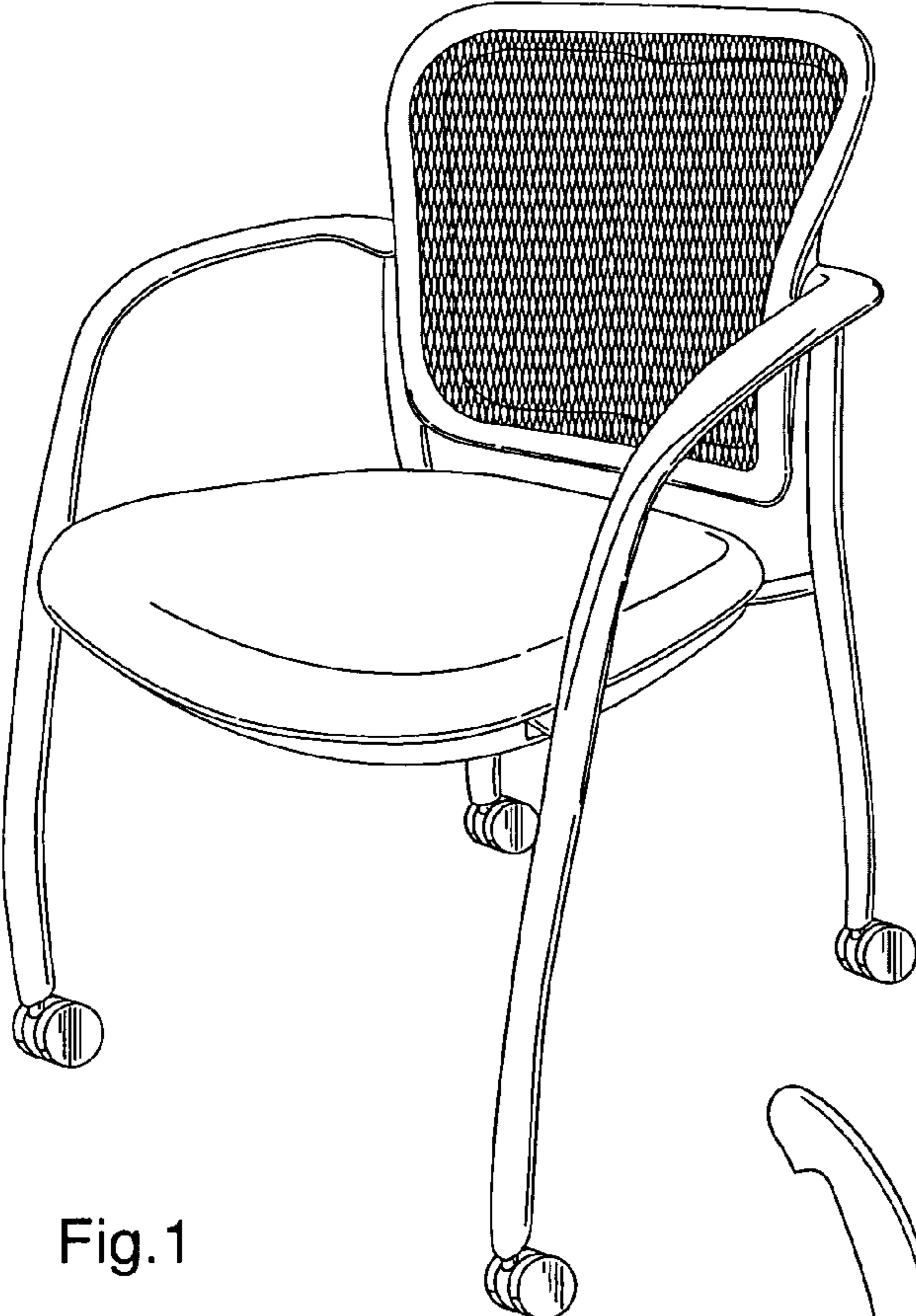

Fig.1

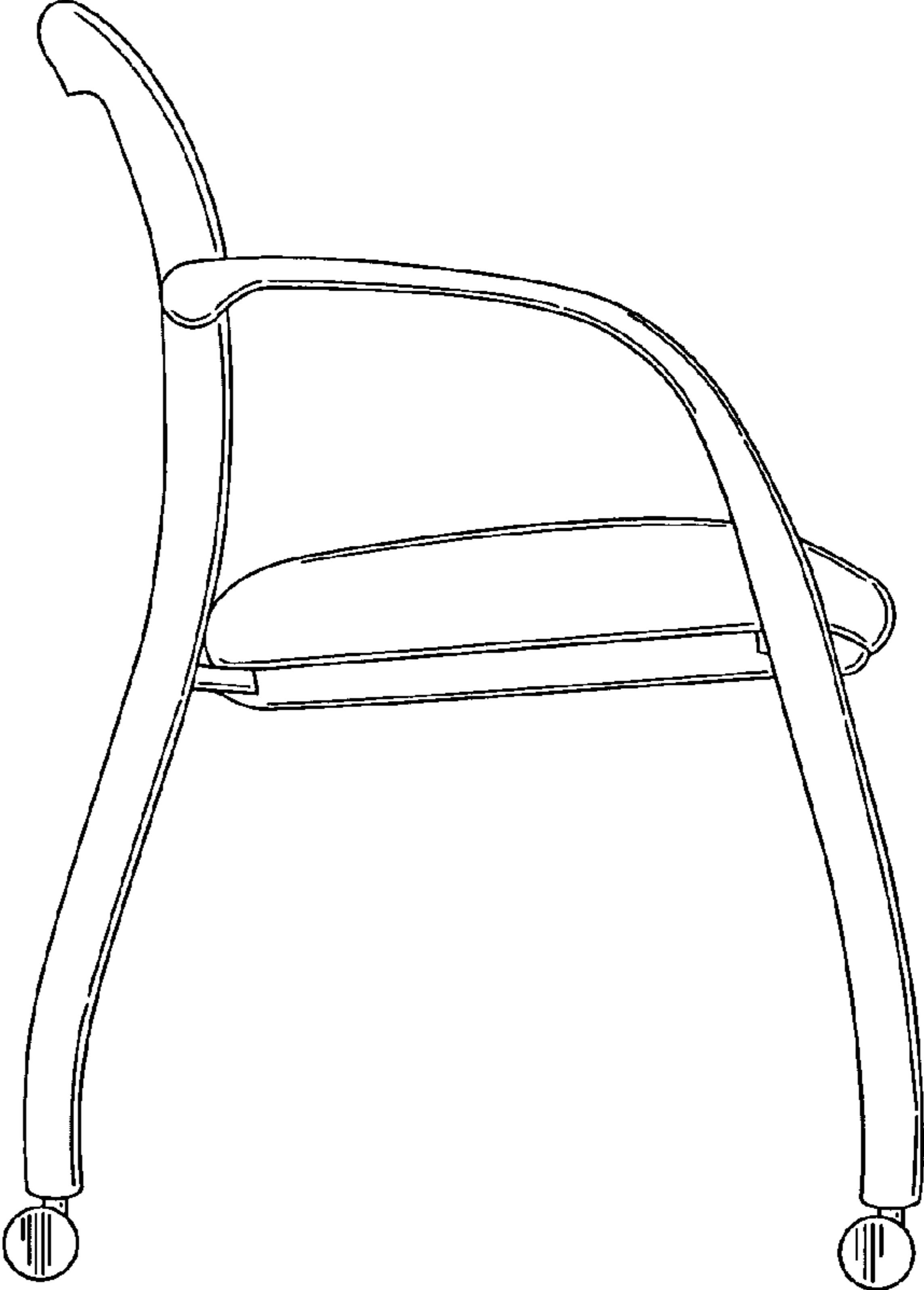

Fig.2

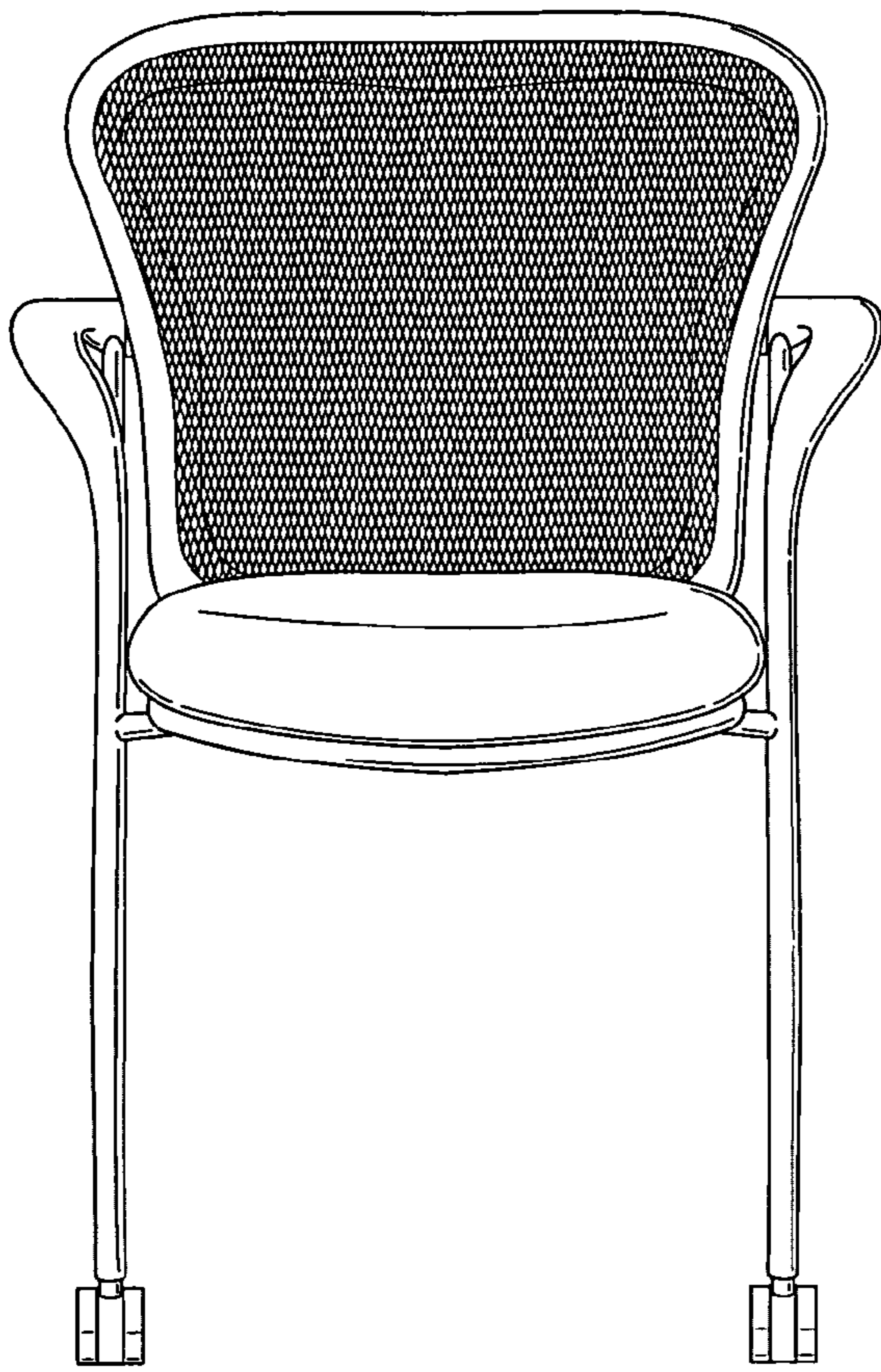

Fig.3

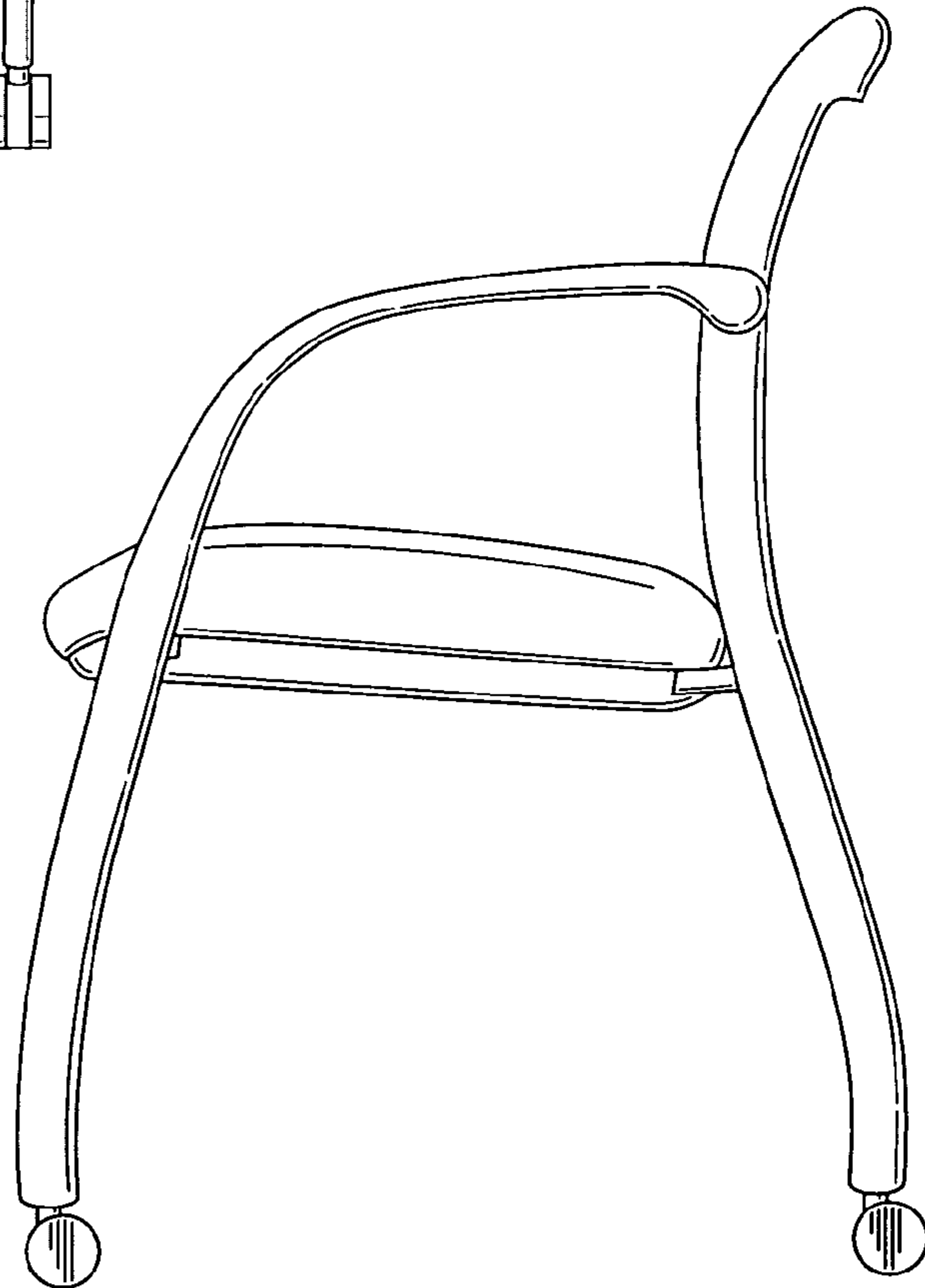

Fig.4

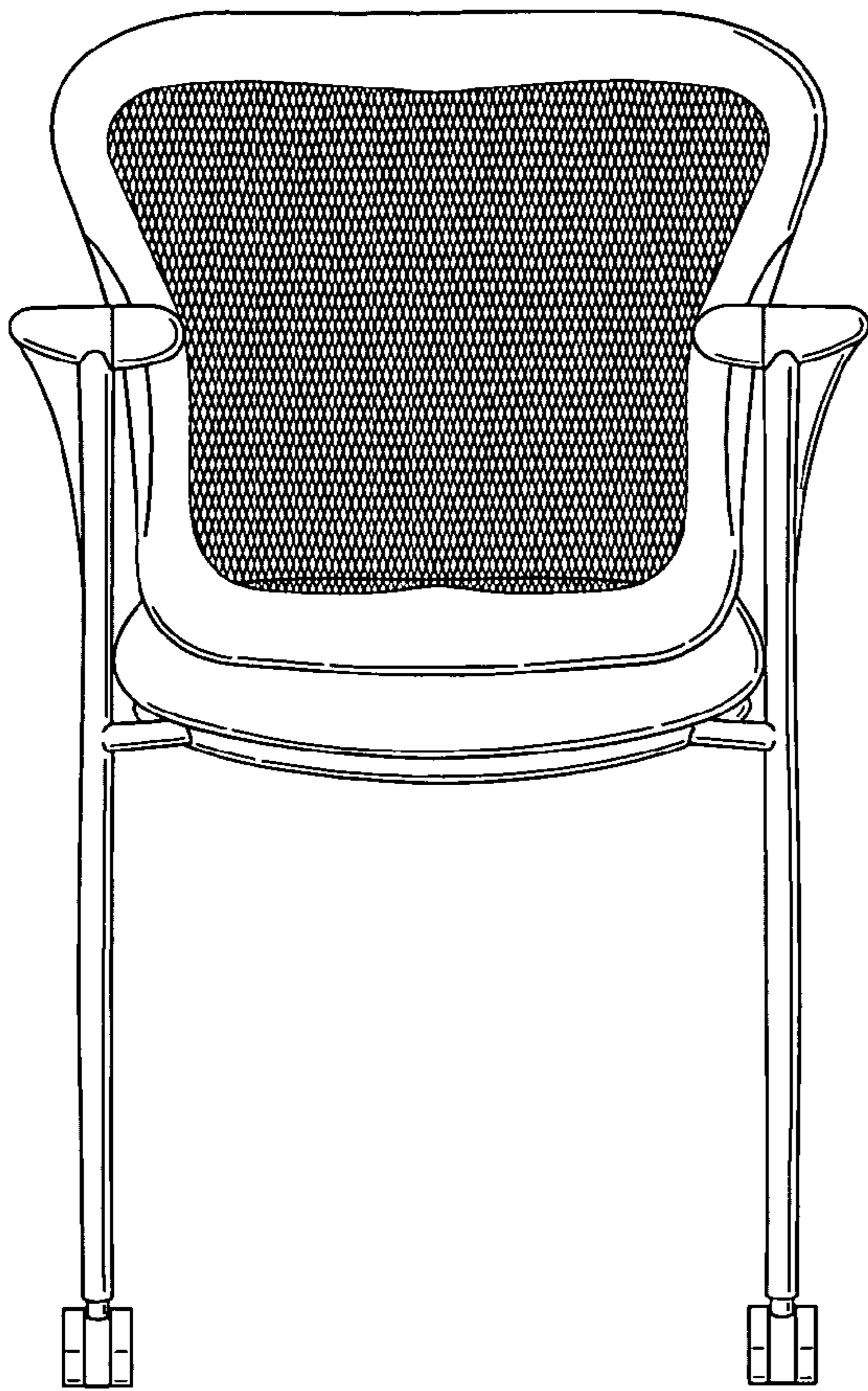

Fig.5

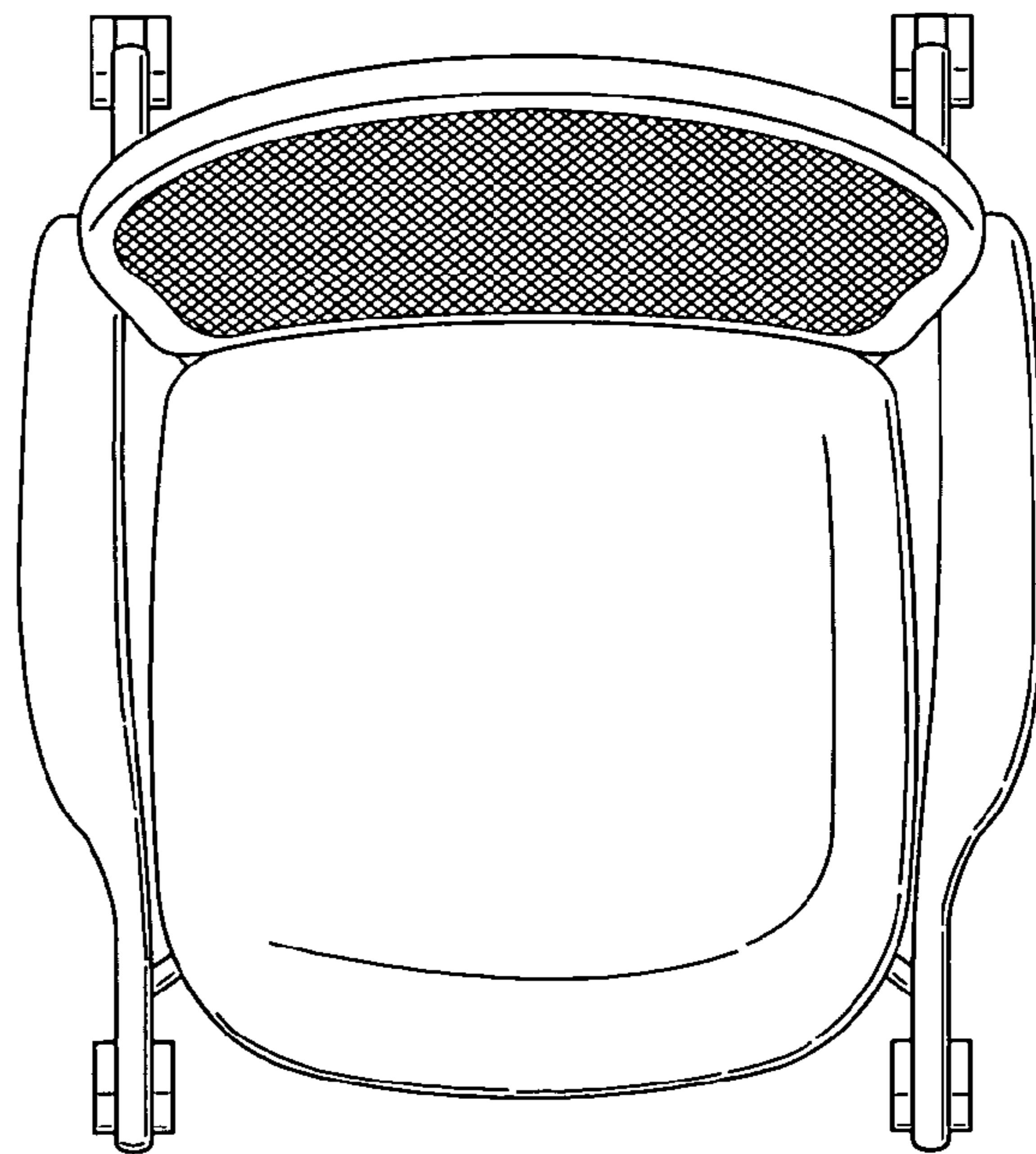

Fig.6

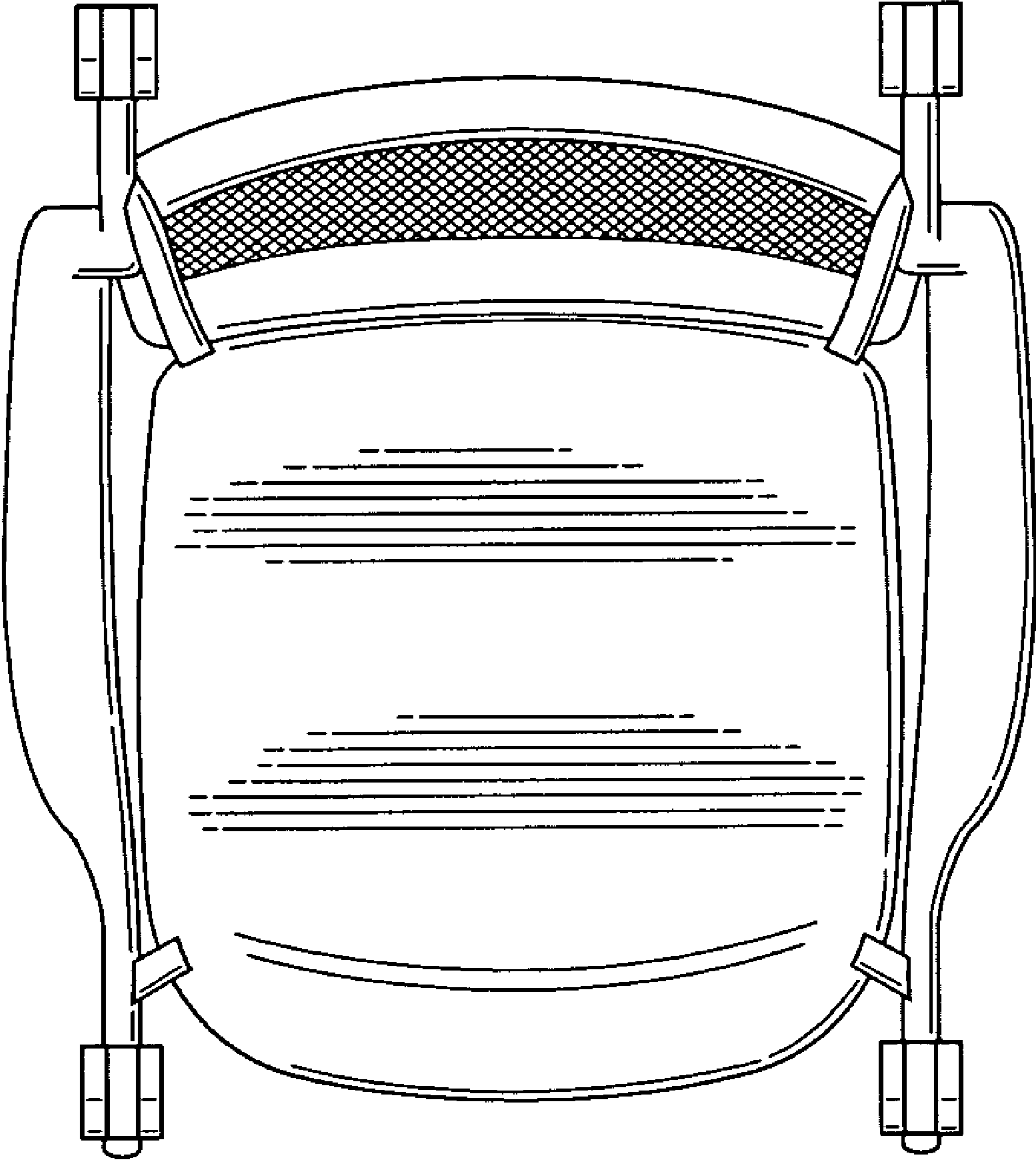

Fig. 7

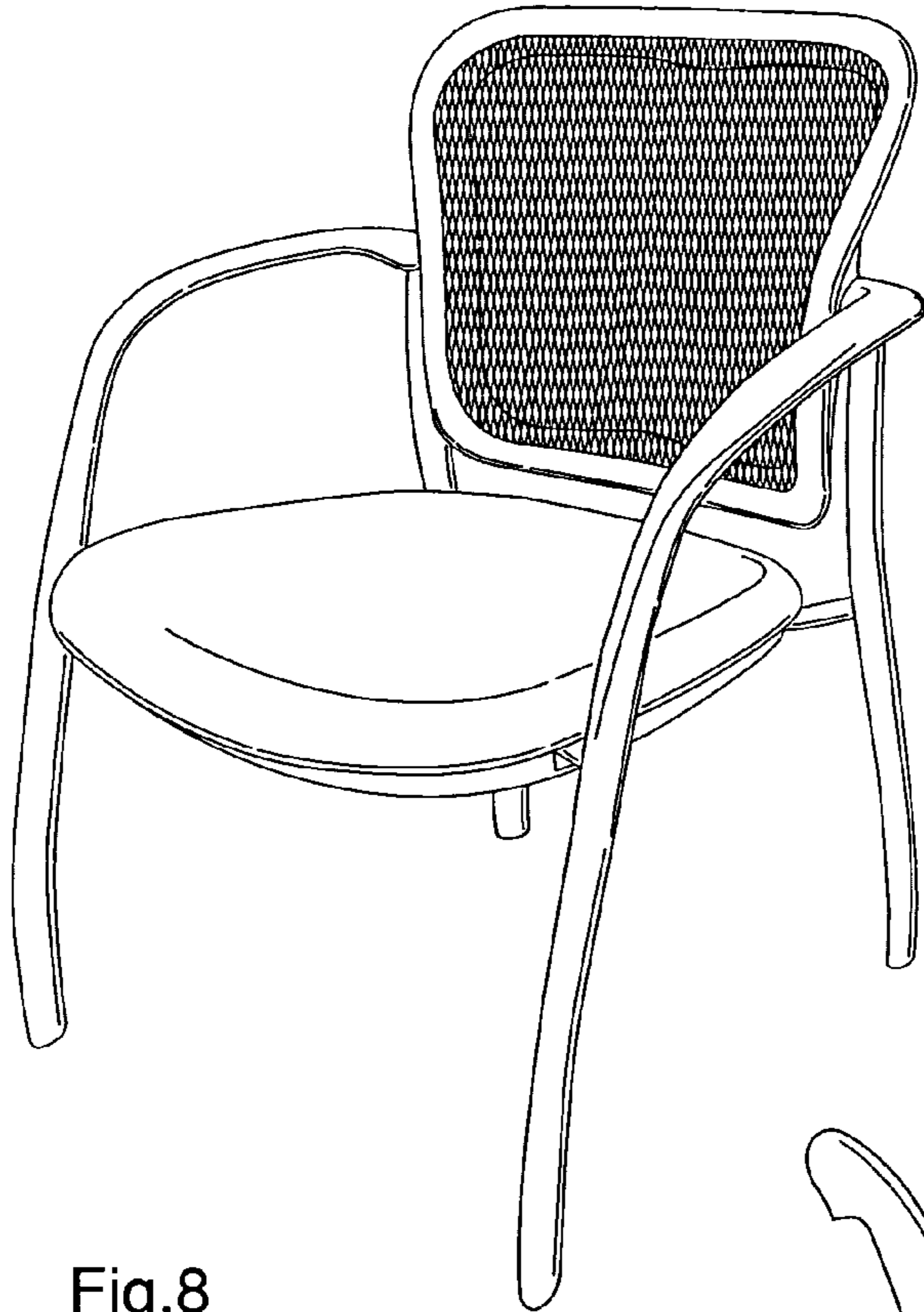

Fig.8

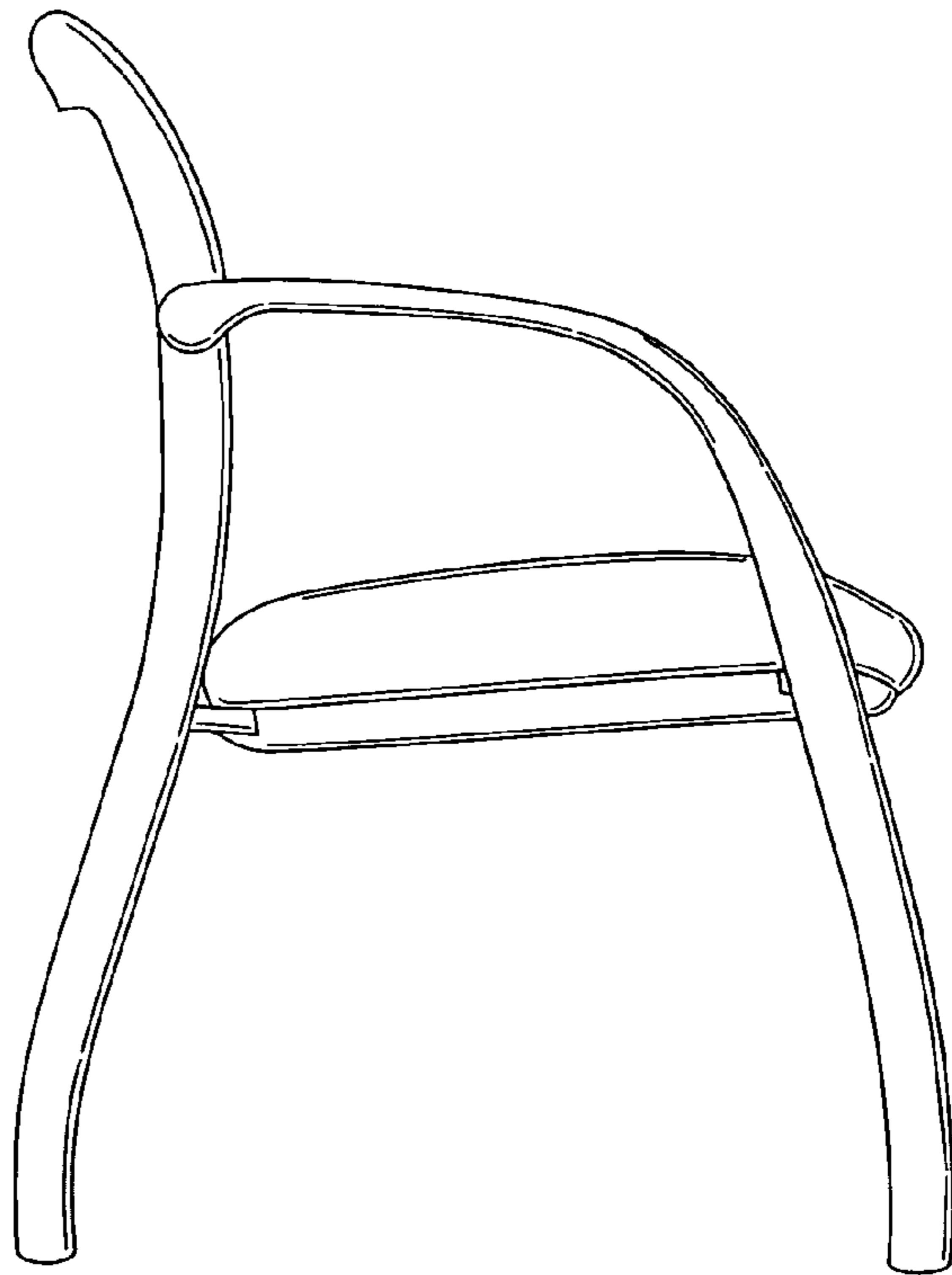

Fig.9

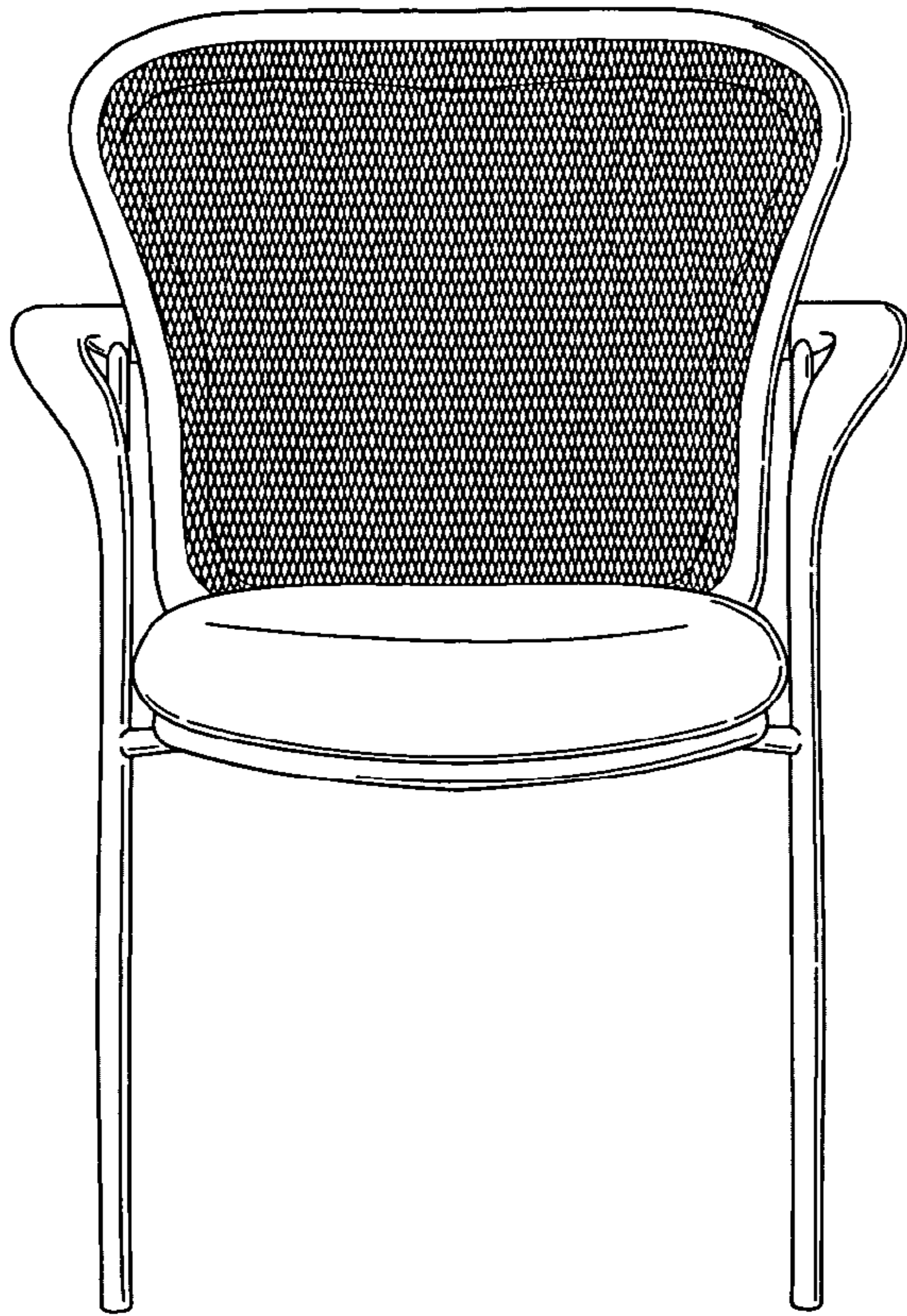

Fig.10

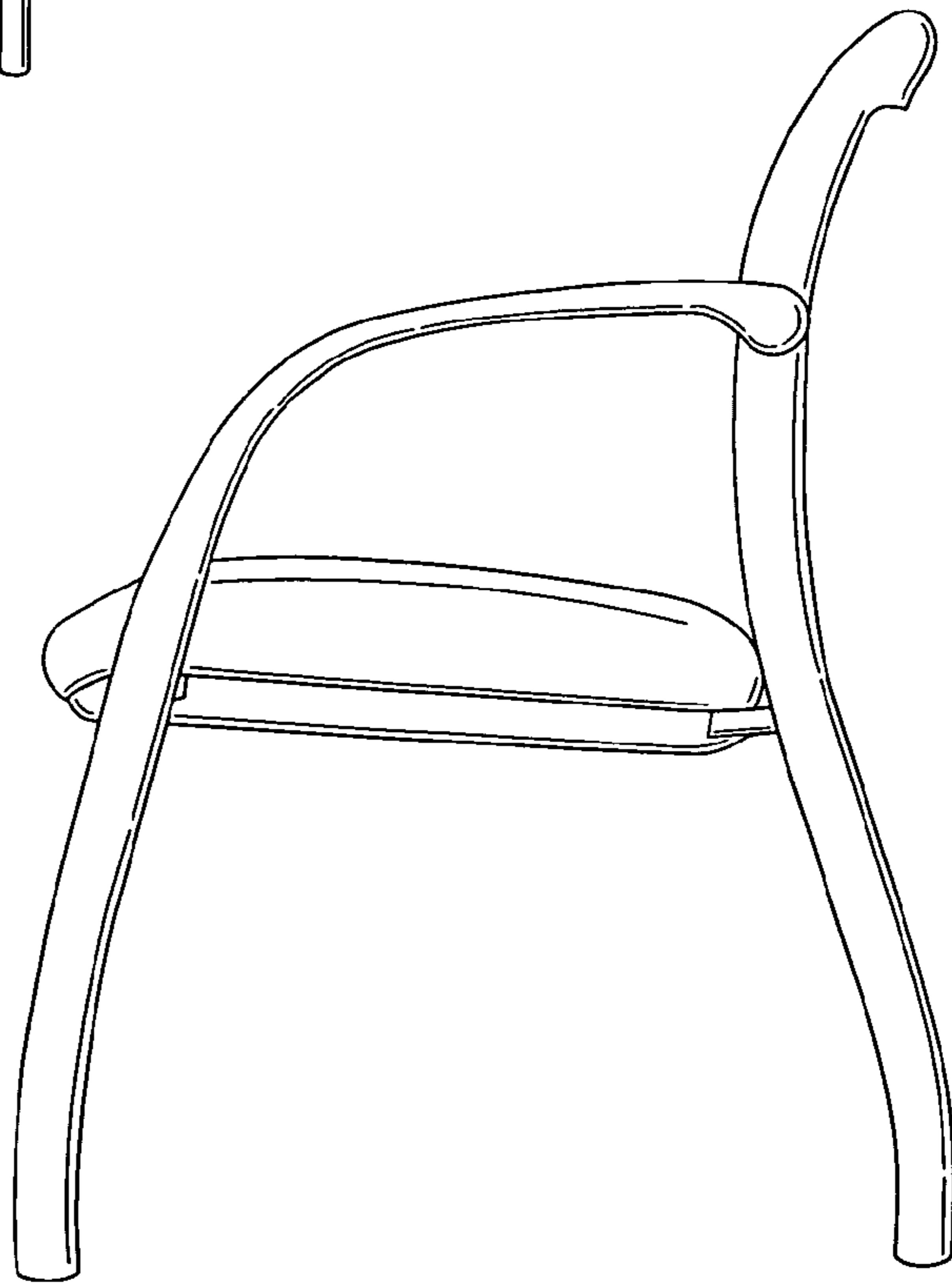

Fig.11

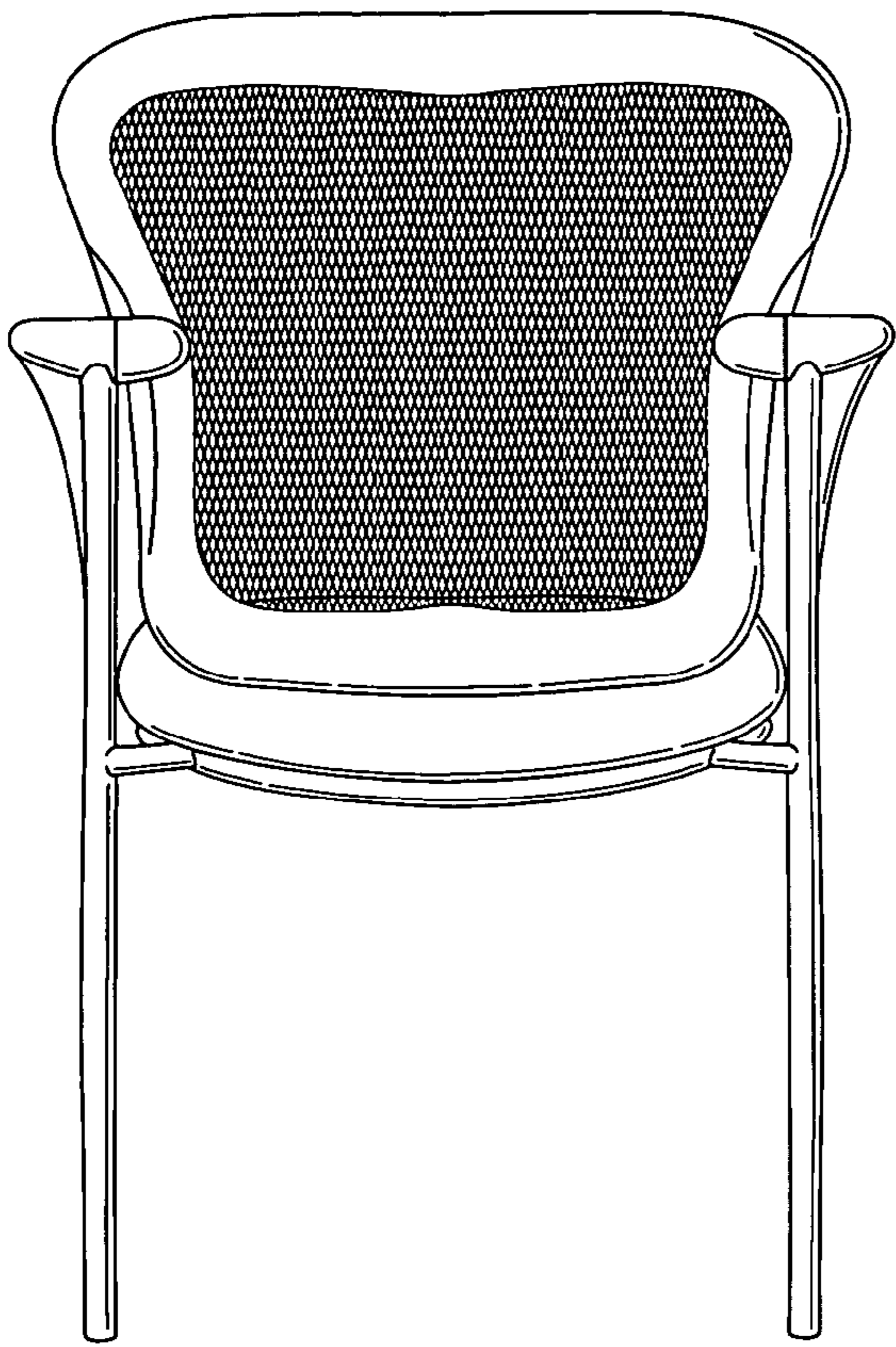

Fig.12

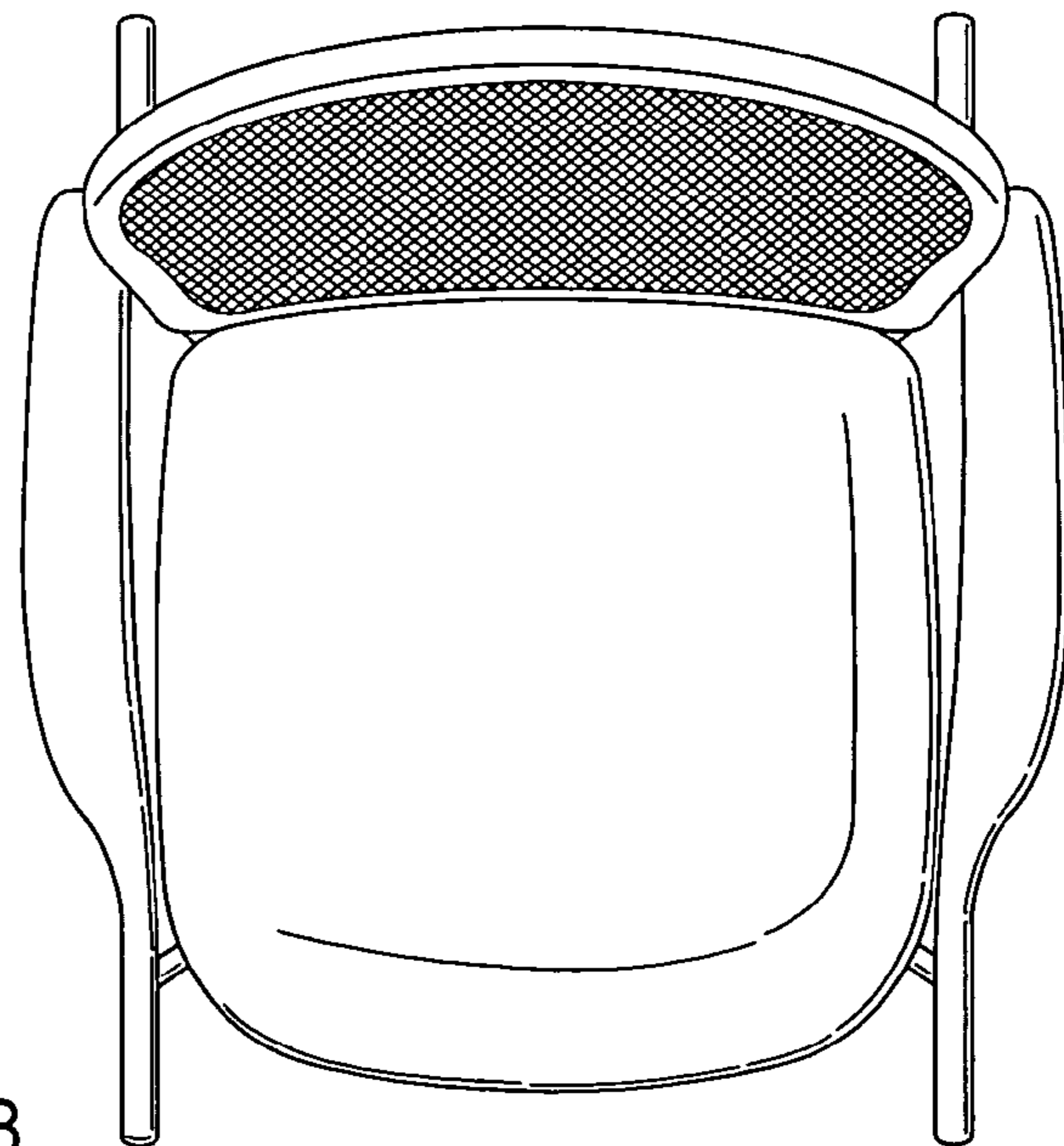

Fig.13

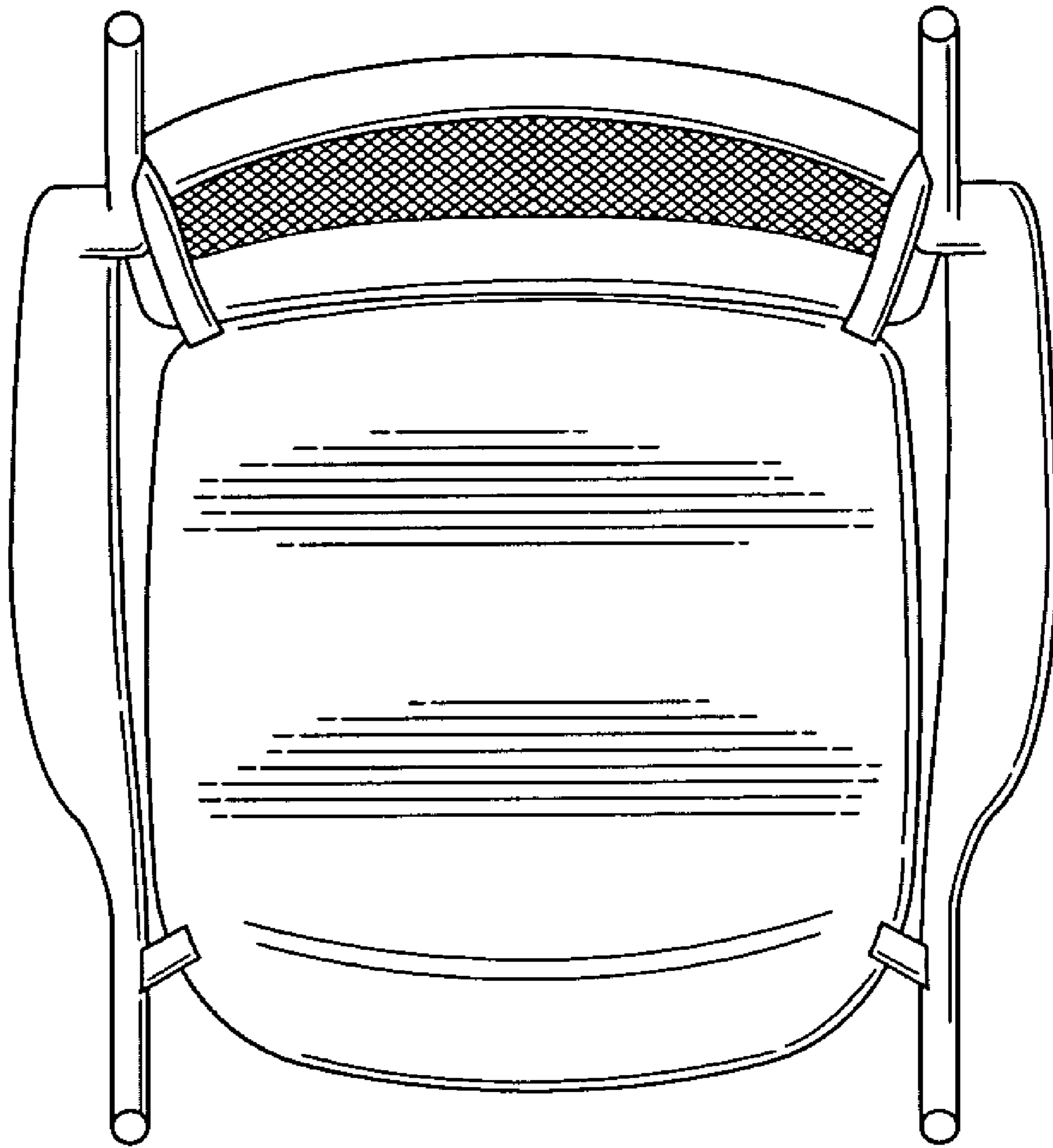

Fig.14