

US00D591396S

(12) **United States Design Patent**  
**Lobermeier**

(10) **Patent No.:** **US D591,396 S**

(45) **Date of Patent:** **\*\* Apr. 28, 2009**

(54) **HAND-HELD SPRAY HEAD**

(75) Inventor: **Hans Lobermeier**, Menden (DE)

(73) Assignee: **Grohe AG**, Hemer (DE)

(\*\*) Term: **14 Years**

(21) Appl. No.: **29/322,893**

(22) Filed: **Aug. 14, 2008**

(51) **LOC (9) Cl.** ..... **23-01**

(52) **U.S. Cl.** ..... **D23/223**

(58) **Field of Classification Search** ..... D23/213,  
D23/223, 229–230; 239/282–283; 4/567,  
4/615

See application file for complete search history.

(56) **References Cited**

**U.S. PATENT DOCUMENTS**

D511,809 S *	11/2005	Haug et al.	.....	D23/223
D535,354 S *	1/2007	Wu	.....	D23/223
D540,426 S *	4/2007	Cropelli	.....	D23/213
D565,703 S *	4/2008	Lammel et al.	.....	D23/223

\* cited by examiner

*Primary Examiner*—Robin V Webster

(74) *Attorney, Agent, or Firm*—Muncy, Geissler, Olds & Lowe, PLLC

(57) **CLAIM**

The ornamental design of a hand-held spray head, as shown and described.

**DESCRIPTION**

FIG. 1 is a perspective view of a hand-held spray head according to a first embodiment of the present invention;

FIG. 2 is a left side elevational view of the hand-held spray head of FIG. 1;

FIG. 3 is a right side elevational view of the hand-held spray head of FIG. 1;

FIG. 4 is a rear elevational view of the hand-held spray head of FIG. 1;

FIG. 5 is a front elevational view of the hand-held spray head of FIG. 1;

FIG. 6 is a bottom plan view of the hand-held spray head of FIG. 1; and,

FIG. 7 is a top plan view of the hand-held spray head of FIG. 1.

**1 Claim, 6 Drawing Sheets**

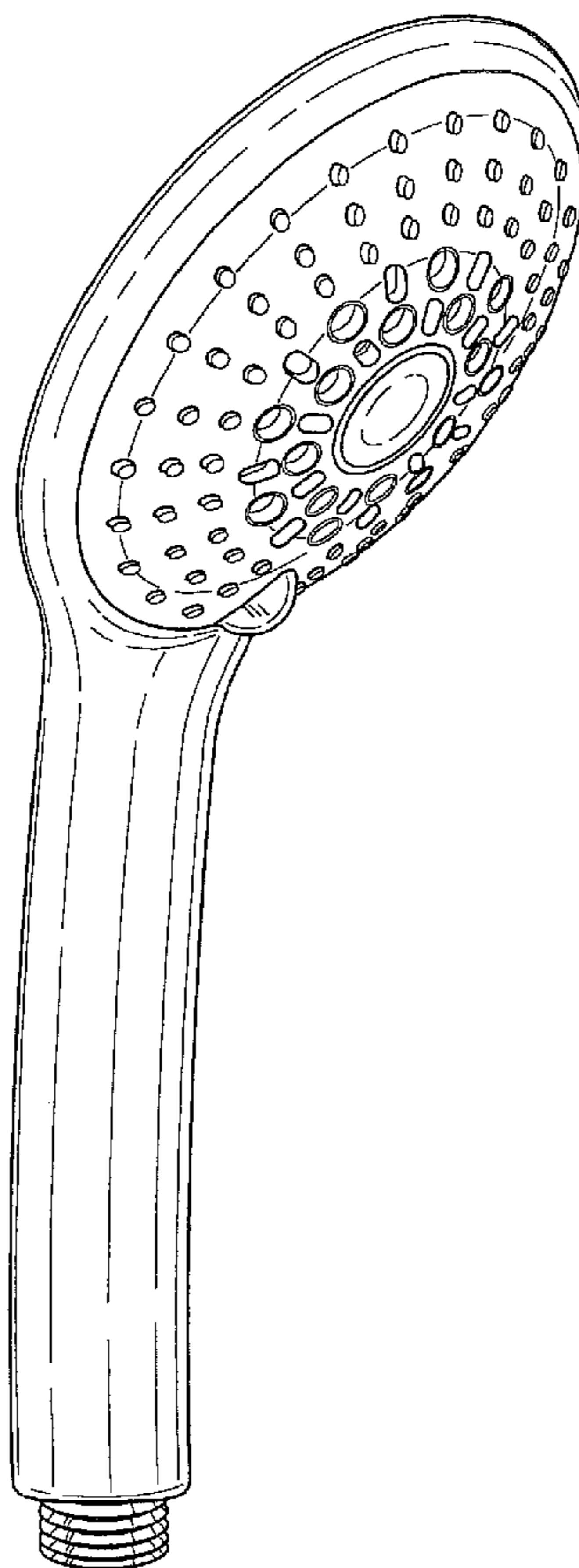

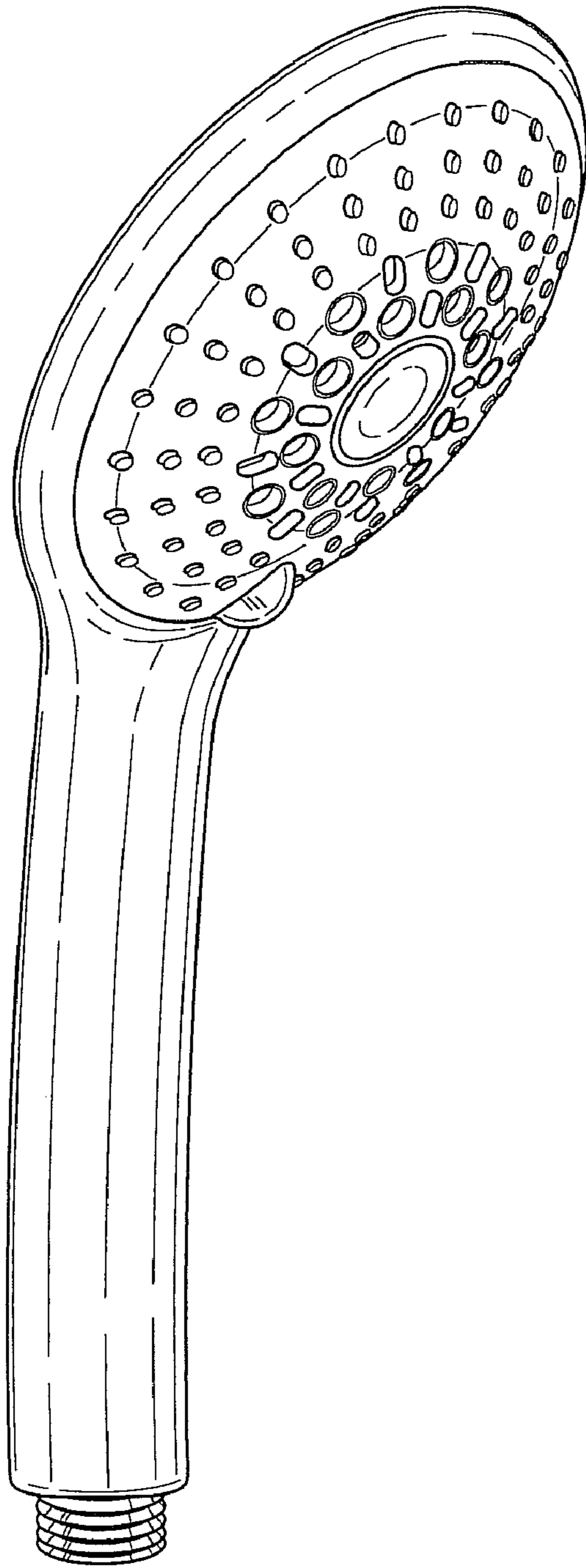

FIG. 1

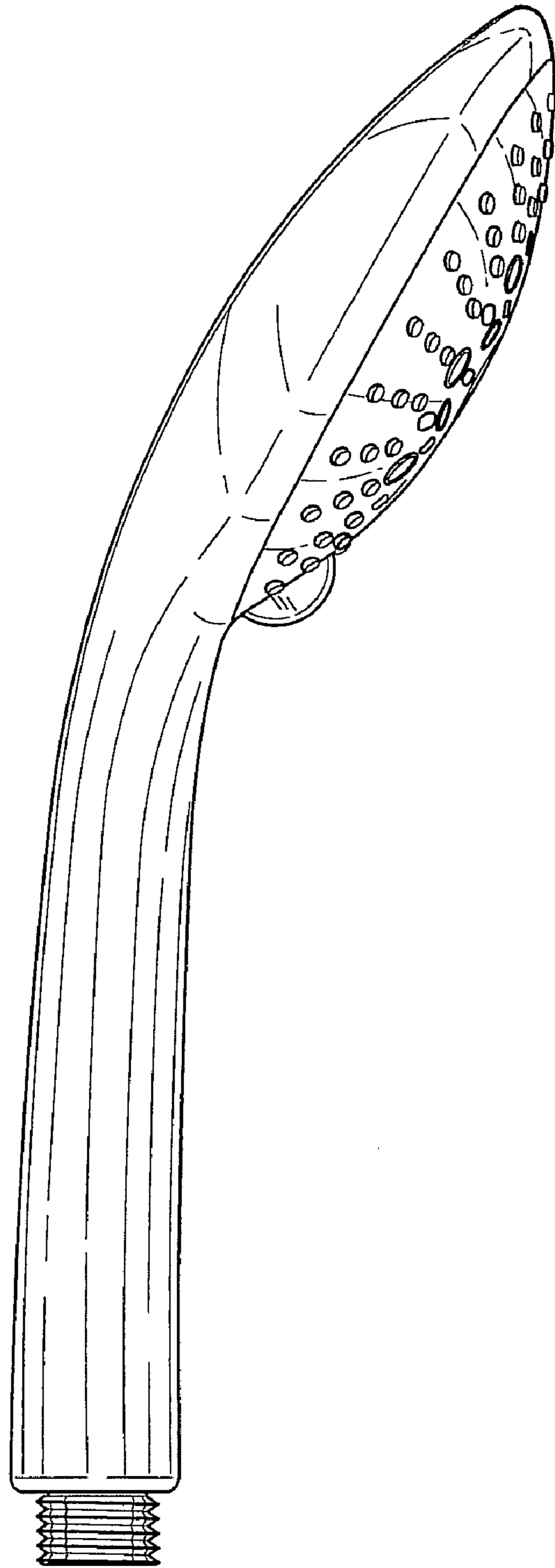

FIG. 2

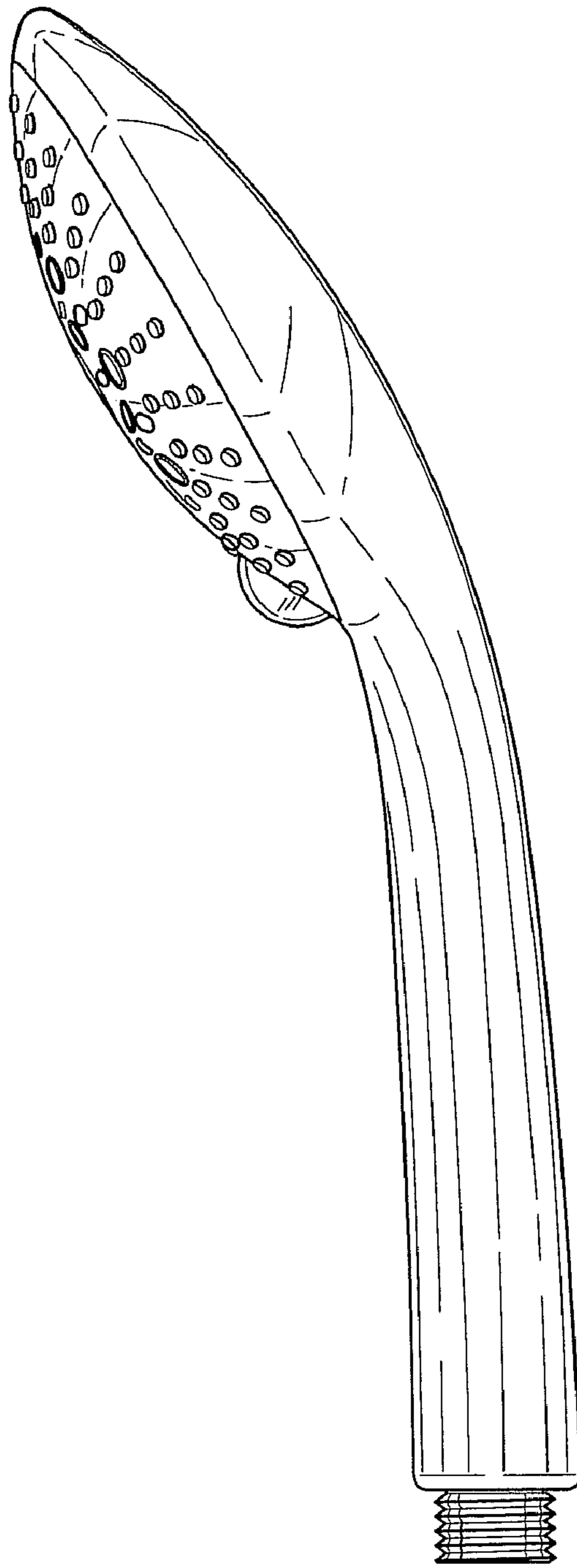

FIG. 3

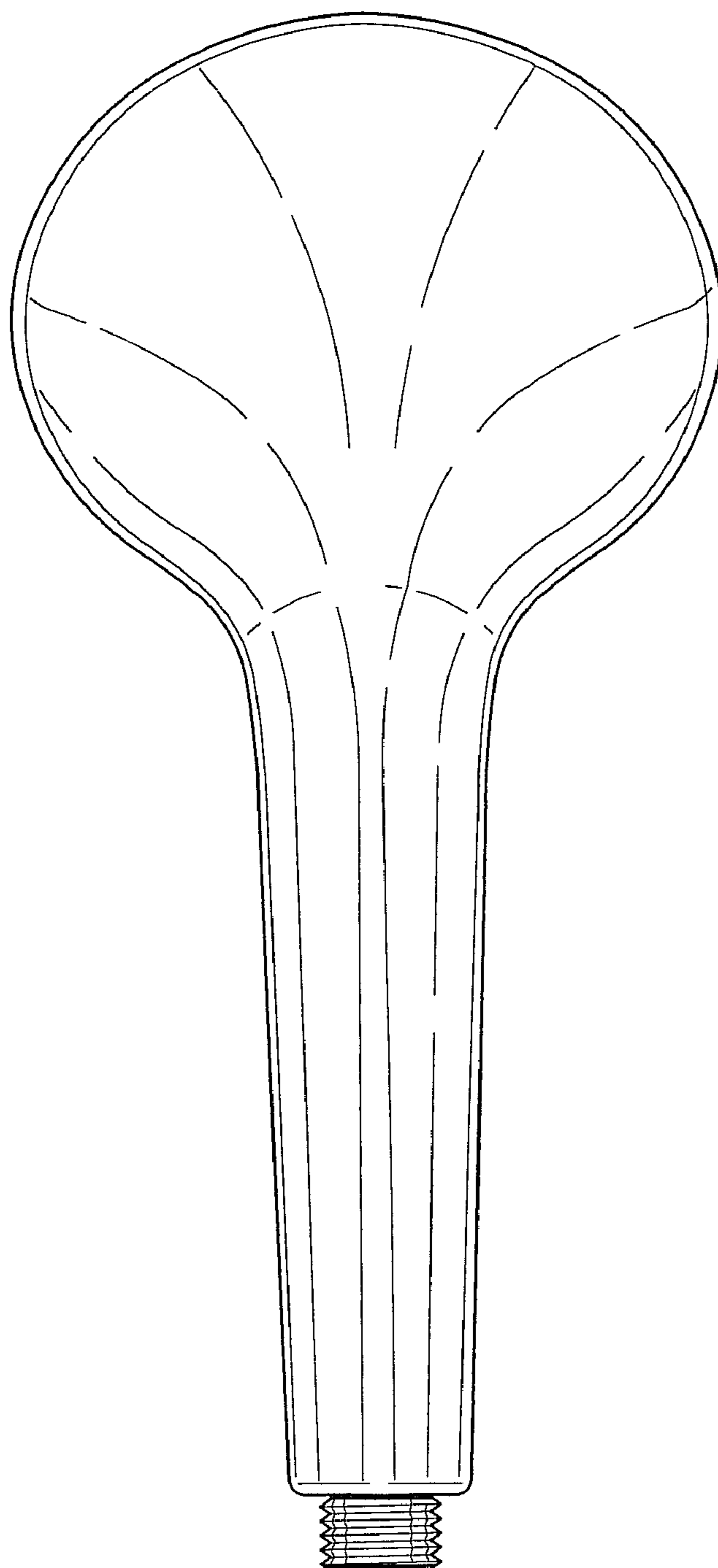

FIG. 4

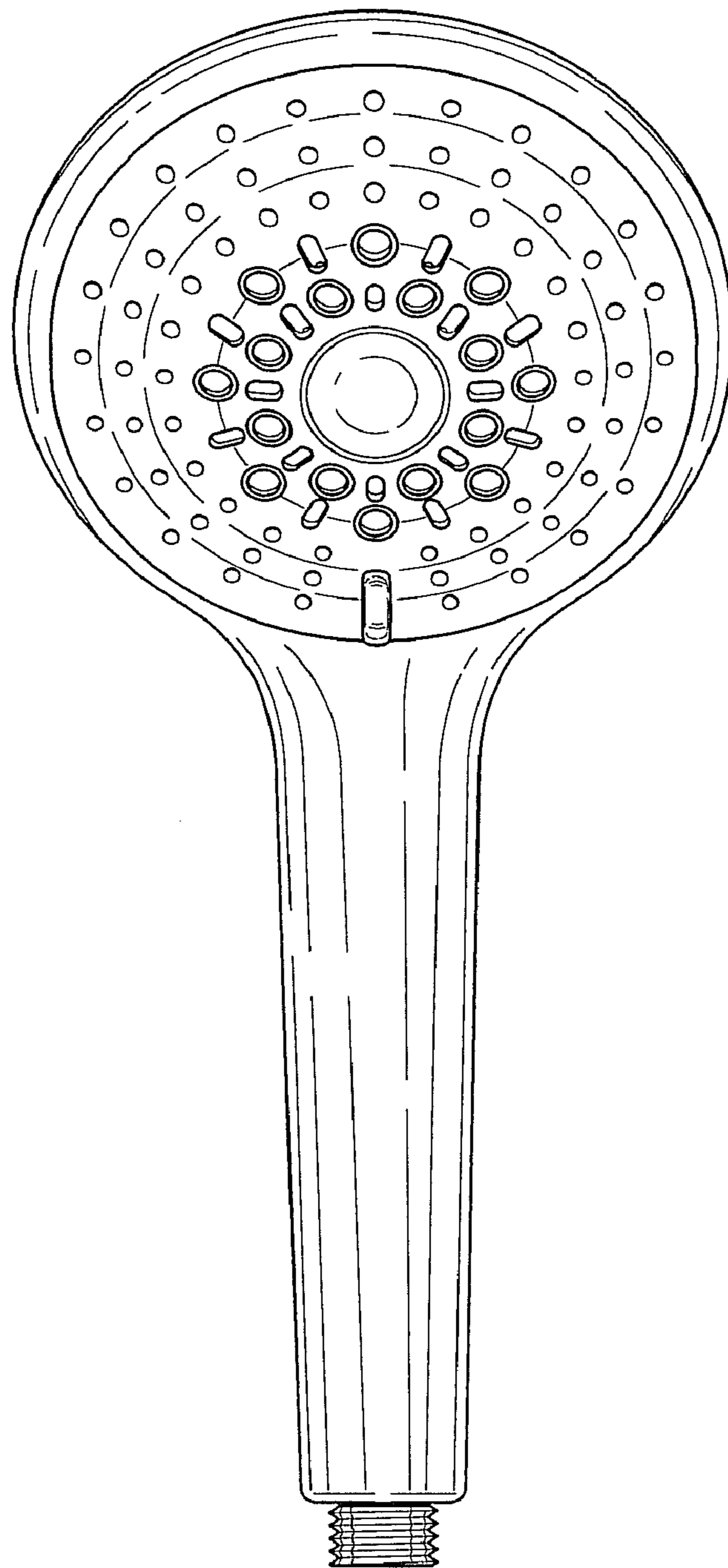

FIG. 5

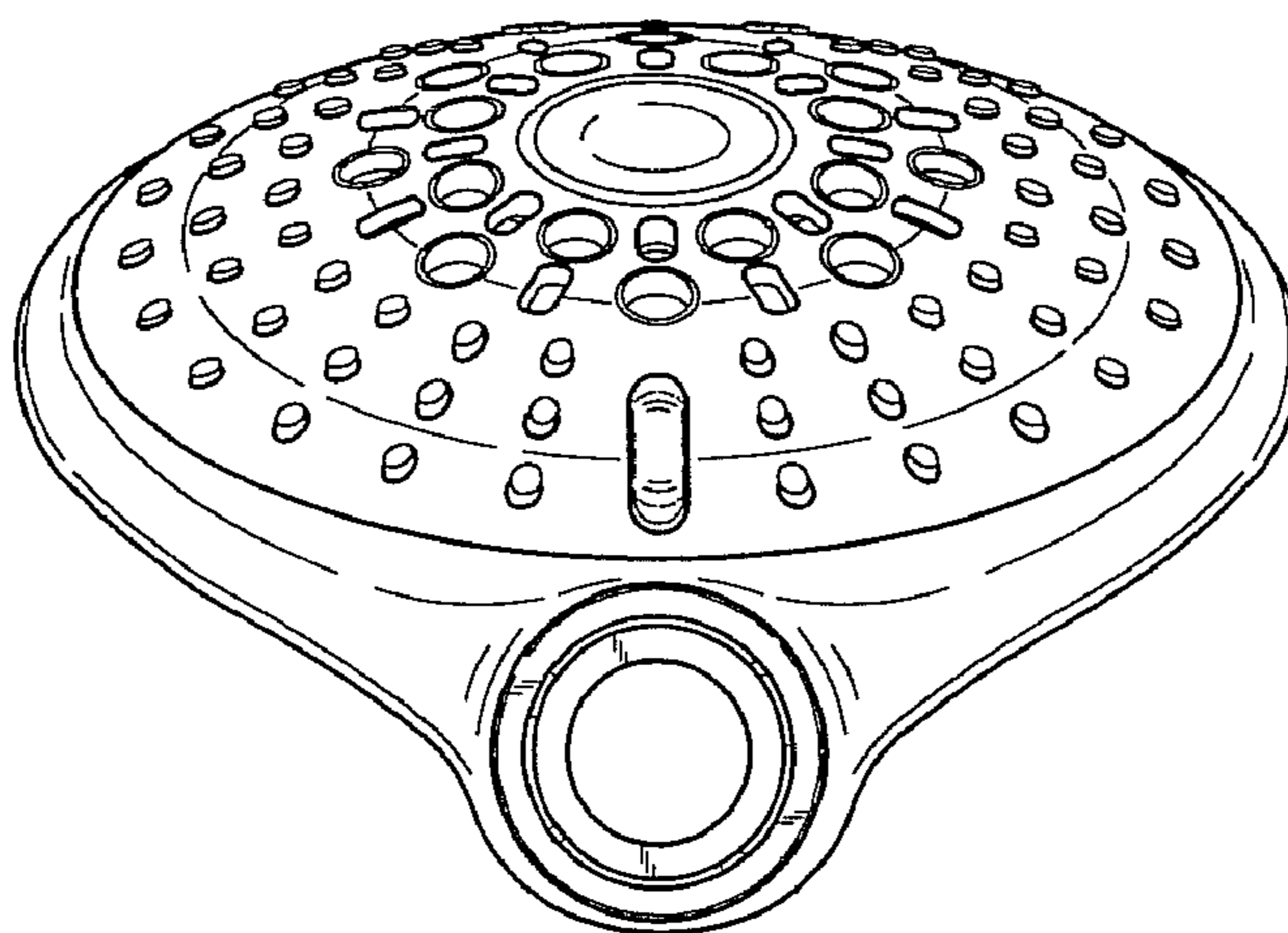

FIG. 6

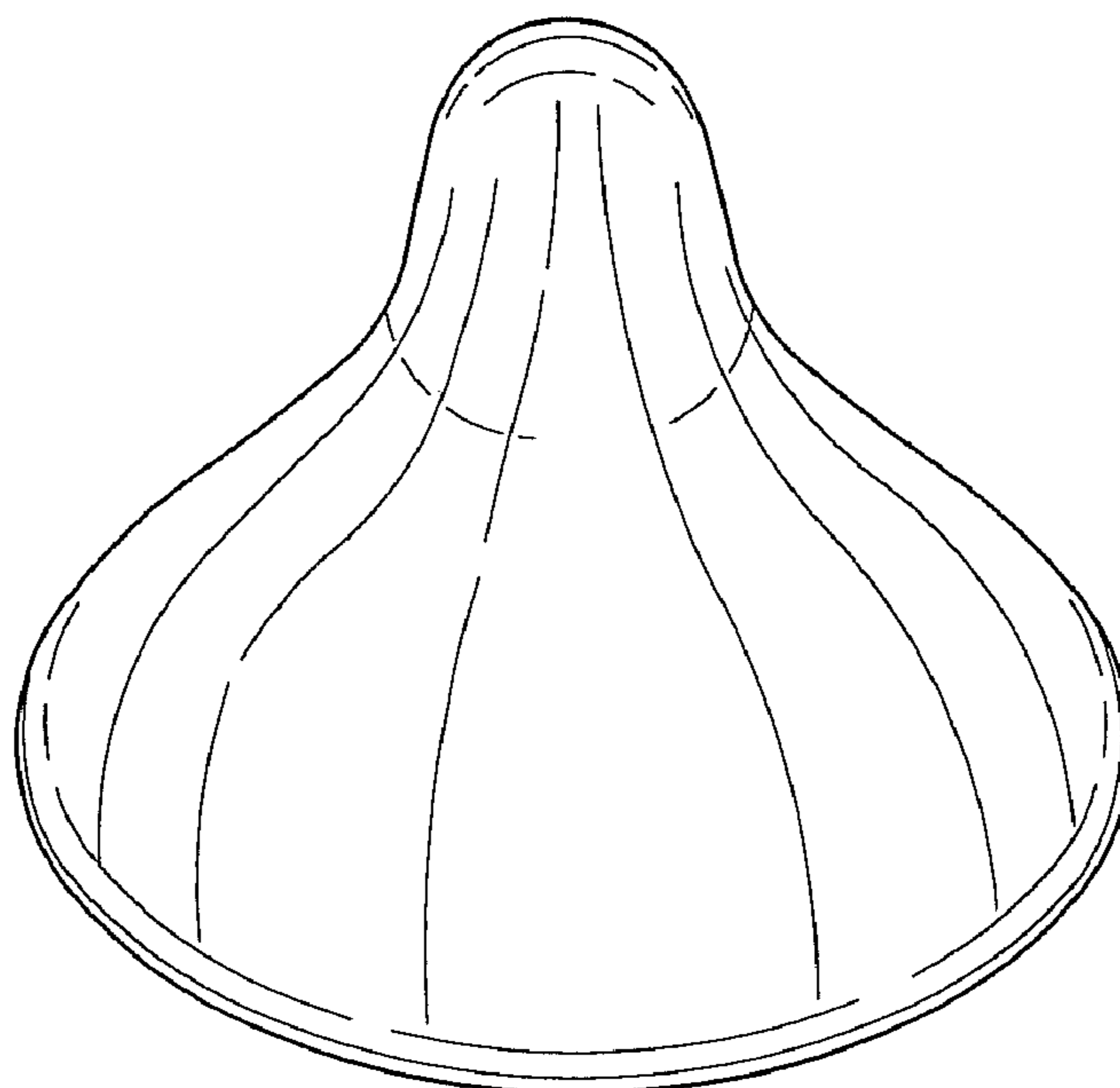

FIG. 7

UNITED STATES PATENT AND TRADEMARK OFFICE  
**CERTIFICATE OF CORRECTION**

PATENT NO. : Des. 591,396 S  
APPLICATION NO. : 29/322893  
DATED : April 28, 2009  
INVENTOR(S) : Lobermeier

Page 1 of 1

It is certified that error appears in the above-identified patent and that said Letters Patent is hereby corrected as shown below:

Please add the following to the Letters Patent

(30) Foreign Application Priority Data

**Feb. 14, 2008 (EU) .....000878889-0005**

Signed and Sealed this

Twenty-third Day of March, 2010



David J. Kappos  
*Director of the United States Patent and Trademark Office*