



US00D591329S

(12) **United States Design Patent**
Wang

(10) **Patent No.:** **US D591,329 S**
(45) **Date of Patent:** **** Apr. 28, 2009**

- (54) **EYEWEAR**
- (75) Inventor: **Bao Lien Wang**, Tainan (TW)
- (73) Assignee: **Wiley X, Inc.**, Livermore, CA (US)
- (**) Term: **14 Years**
- (21) Appl. No.: **29/293,695**
- (22) Filed: **Dec. 7, 2007**

- 3,610,743 A 10/1971 Lindblom
- 3,708,224 A 1/1973 Lindblom
- 4,176,410 A 12/1979 Matthias
- D275,574 S 9/1984 Feinbloom
- 4,515,448 A 5/1985 Tackles
- 4,674,851 A 6/1987 Jannard
- D293,450 S 12/1987 Jannard
- 4,730,915 A 3/1988 Jannard
- 4,779,291 A 10/1988 Russell
- 4,785,481 A 11/1988 Palmer, III et al.
- 4,820,035 A 4/1989 Kanda
- 4,822,161 A 4/1989 Jimmy

Related U.S. Application Data

- (63) Continuation of application No. 29/270,876, filed on Jan. 4, 2007, now abandoned.

- (51) **LOC (9) Cl.** **16-06**
 - (52) **U.S. Cl.** **D16/315; D16/309**
 - (58) **Field of Classification Search** D16/101, D16/300-342; D29/109-110; D24/110.2; 351/41, 44, 51-52, 62, 158, 92, 103-123, 351/140, 153; 2/426-432, 447-449, 441, 2/434-437; D21/483, 659-661
- See application file for complete search history.

(56) **References Cited**

U.S. PATENT DOCUMENTS

- 600,496 A 3/1898 Meyrowitz
- 1,647,107 A 10/1927 Franchini
- 1,853,872 A 4/1932 Meyrowitz
- 1,910,460 A 5/1933 Boutelle
- 1,923,566 A 8/1933 Baker
- 1,942,393 A 1/1934 Baker
- 2,027,037 A 1/1936 Gottlieb
- 2,157,247 A 5/1939 Schumacher
- 2,534,748 A 12/1950 Willson
- 2,918,676 A 12/1959 Matheson
- 3,233,249 A 2/1966 Baratelli et al.
- 3,233,250 A 2/1966 Jonassen
- 3,517,393 A 6/1970 Beauchef

(Continued)

OTHER PUBLICATIONS

Wang, Bao Lien, Eyewear with Releasable Adjustable Nosepiece, U.S. Appl. No. 11/650,035, filed Jan. 4, 2007.

(Continued)

Primary Examiner—Raphael Barkai
(74) *Attorney, Agent, or Firm*—James R. Cypher; Charles R. Cypher

(57) **CLAIM**

The ornamental design for eyewear, as shown and described.

DESCRIPTION

FIG. 1 is a front perspective view of the eyewear showing my design.
FIG. 2 is rear perspective view of the eyewear.
FIG. 3 is a front elevation view of the eyewear.
FIG. 4 is a side elevation view of the eyewear.
FIG. 5 is a top plan view of the eyewear.
FIG. 6 is a rear elevation view of the eyewear; and,
FIG. 7 is a bottom plan view of the eyewear.

1 Claim, 5 Drawing Sheets

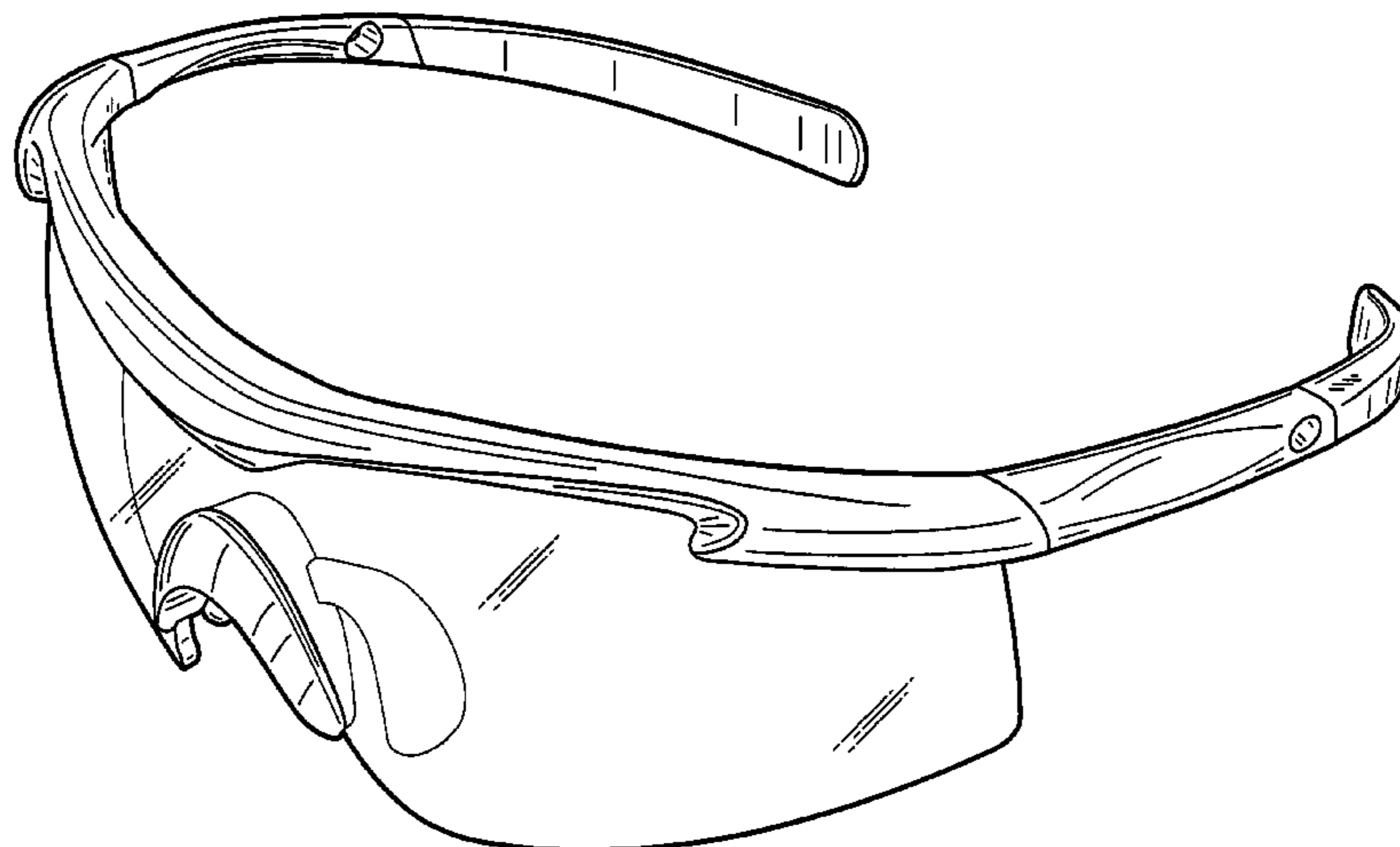

US D591,329 S

Page 2

U.S. PATENT DOCUMENTS

| | | | | | | | |
|-----------|---|---------|--------------------|-----------|----|---------|-----------------|
| 4,824,233 | A | 4/1989 | Jannard | D408,841 | S | 4/1999 | Conway |
| 4,859,048 | A | 8/1989 | Jannard | 5,894,606 | A | 4/1999 | Chiang |
| 4,867,550 | A | 9/1989 | Jannard | D410,485 | S | 6/1999 | Jannard et al. |
| 4,868,930 | A | 9/1989 | Blackstone | D418,535 | S | 1/2000 | Hartman |
| 4,934,807 | A | 6/1990 | Bolle et al. | 6,062,688 | A | 5/2000 | Vinas |
| D311,196 | S | 10/1990 | Wiedmann | D429,754 | S | 8/2000 | Markovitz |
| 4,977,627 | A | 12/1990 | Metcalf et al. | D431,587 | S | 10/2000 | Yang |
| 5,054,903 | A | 10/1991 | Jannard et al. | 6,139,144 | A | 10/2000 | Hynansky |
| 5,056,163 | A | 10/1991 | Chou | 6,183,081 | B1 | 2/2001 | Ono et al. |
| D322,975 | S | 1/1992 | Bolle | D438,886 | S | 3/2001 | Freeman |
| 5,098,180 | A | 3/1992 | Tobey | 6,282,727 | B1 | 9/2001 | Lindahl |
| 5,187,503 | A | 2/1993 | Hilton | 6,315,408 | B1 | 11/2001 | Huang |
| D339,596 | S | 9/1993 | Kopfer | D456,037 | S | 4/2002 | Tabacchi |
| 5,243,711 | A | 9/1993 | Graham | D456,441 | S | 4/2002 | Jannard et al. |
| D347,016 | S | 5/1994 | Bolle | 6,450,639 | B1 | 9/2002 | Abraham |
| 5,363,512 | A | 11/1994 | Grabos, Jr. et al. | D467,262 | S | 12/2002 | Wang |
| 5,371,554 | A | 12/1994 | Aspesi | 6,494,573 | B1 | 12/2002 | Huang |
| 5,386,254 | A | 1/1995 | Kahaney | 6,513,171 | B1 | 2/2003 | Soper |
| 5,410,763 | A | 5/1995 | Bolle | 6,513,926 | B1 | 2/2003 | Kizu |
| 5,412,438 | A | 5/1995 | Bolle | D473,582 | S | 4/2003 | Gardner |
| 5,444,876 | A | 8/1995 | Cooper et al. | 6,557,995 | B1 | 5/2003 | Edwards |
| 5,526,070 | A | 6/1996 | Simioni | 6,582,074 | B1 | 6/2003 | Chen |
| 5,542,130 | A | 8/1996 | Grabos, Jr. et al. | 6,611,966 | B1 | 9/2003 | Yamamoto et al. |
| 5,576,775 | A | 11/1996 | Bolle | 6,637,038 | B1 | 10/2003 | Hussey |
| 5,614,963 | A | 3/1997 | Parker | D485,856 | S | 1/2004 | Wolfe |
| 5,652,965 | A | 8/1997 | Crooks | 6,692,124 | B2 | 2/2004 | Katz et al. |
| 5,682,621 | A | 11/1997 | Park | D495,356 | S | 8/2004 | Freeman |
| 5,687,428 | A | 11/1997 | Yamamoto | 6,799,847 | B2 | 10/2004 | Caplan |
| D387,792 | S | 12/1997 | Bondet | D497,932 | S | 11/2004 | Hou |
| D388,454 | S | 12/1997 | Freeman et al. | 6,883,184 | B2 | 4/2005 | Lee |
| 5,711,035 | A | 1/1998 | Haslbeck | 7,147,321 | B2 | 12/2006 | Van Atta |
| D391,598 | S | 3/1998 | Simioni | D537,097 | S | 2/2007 | Freeman |
| D392,992 | S | 3/1998 | Freeman et al. | D537,860 | S | 3/2007 | Freeman |
| 5,784,143 | A | 7/1998 | Chang | | | | |
| D397,132 | S | 8/1998 | Yee | | | | |
| D402,681 | S | 12/1998 | MacWilliamson | | | | |
| 5,868,104 | A | 2/1999 | Ramirez | | | | |
| D408,432 | S | 4/1999 | Jumara | | | | |

OTHER PUBLICATIONS

WileyX Eyewear 2000/01 Catalog, at least as early as Oct. 6, 2000, pp. 8-12 and the cover, Protective Optics, Inc., Livermore, California.
BS Sunglasses & Goggles Body Specs 2004 Catalog, at least as early as 2004, pp. 2, 4 and the cover, Body Specs, Grass Valley, California.

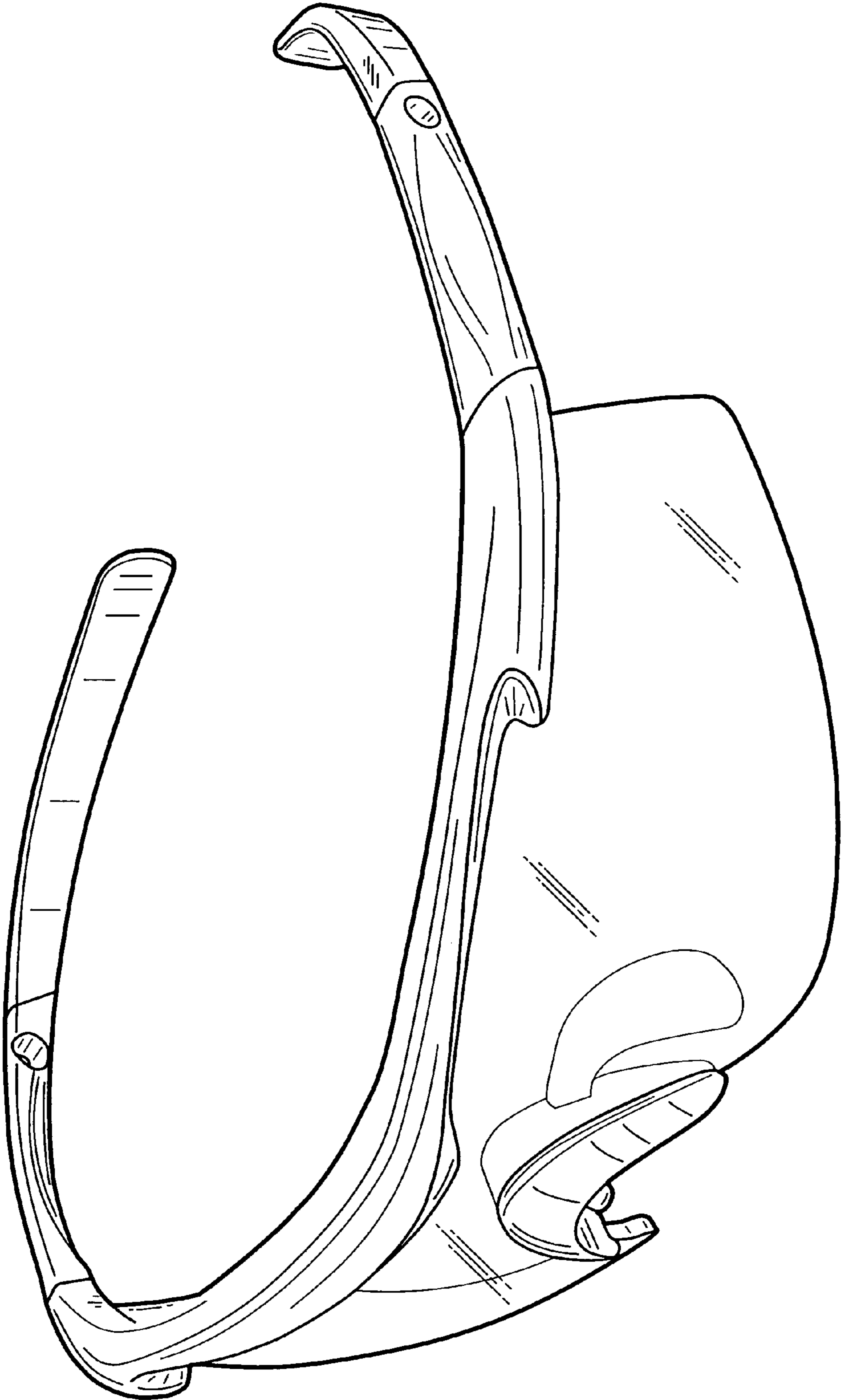

FIG. 1

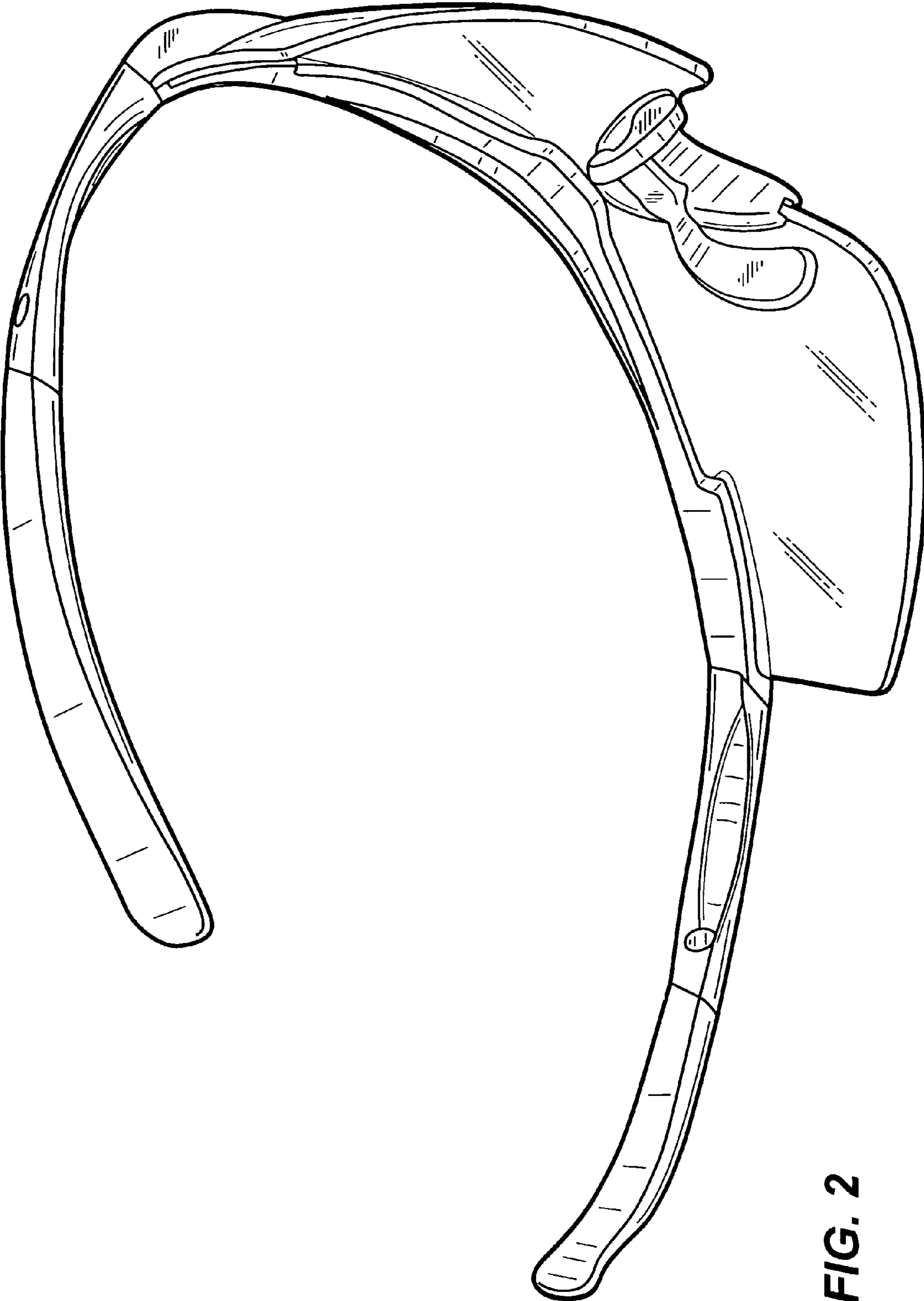

FIG. 2

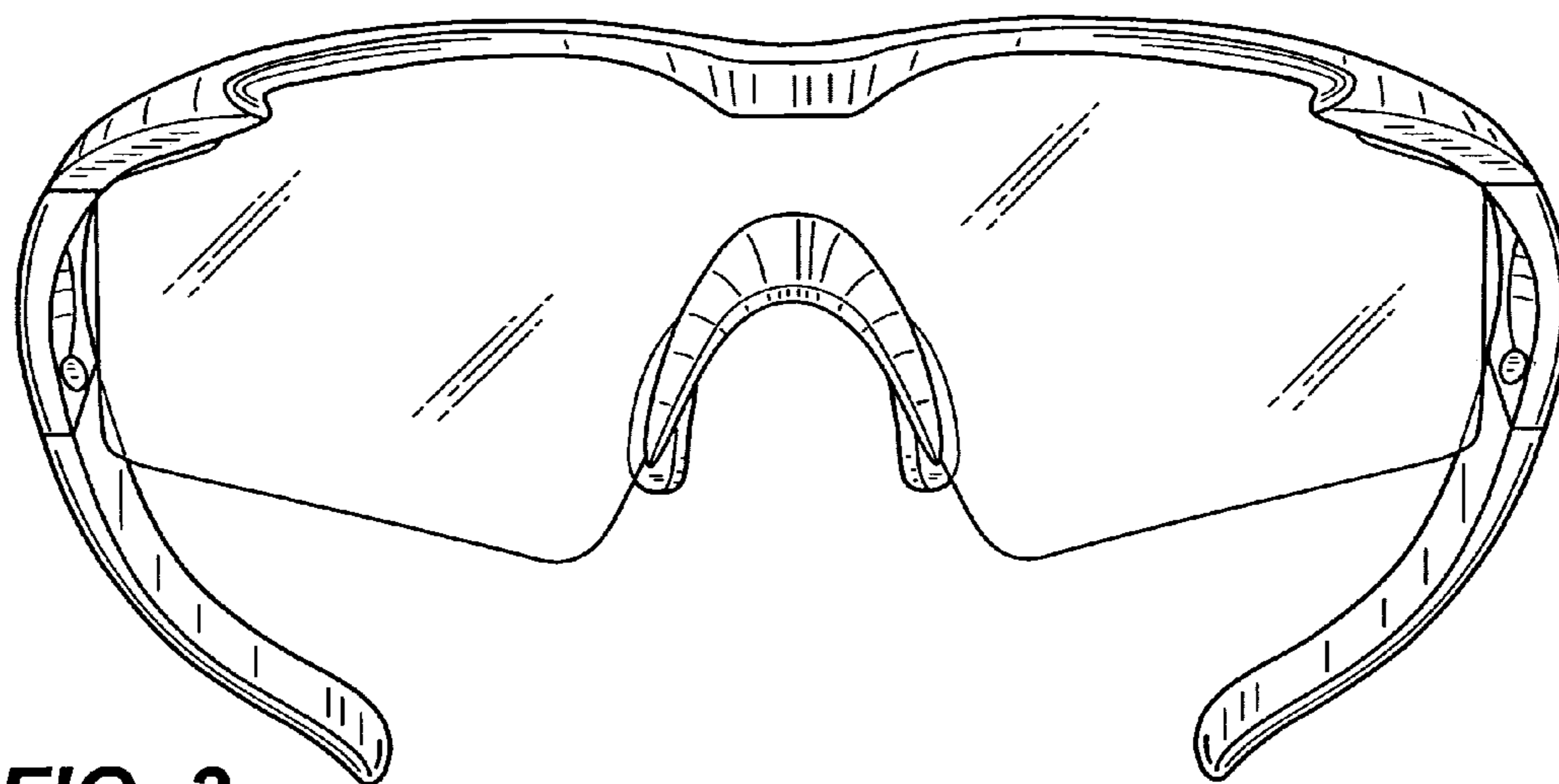

FIG. 3

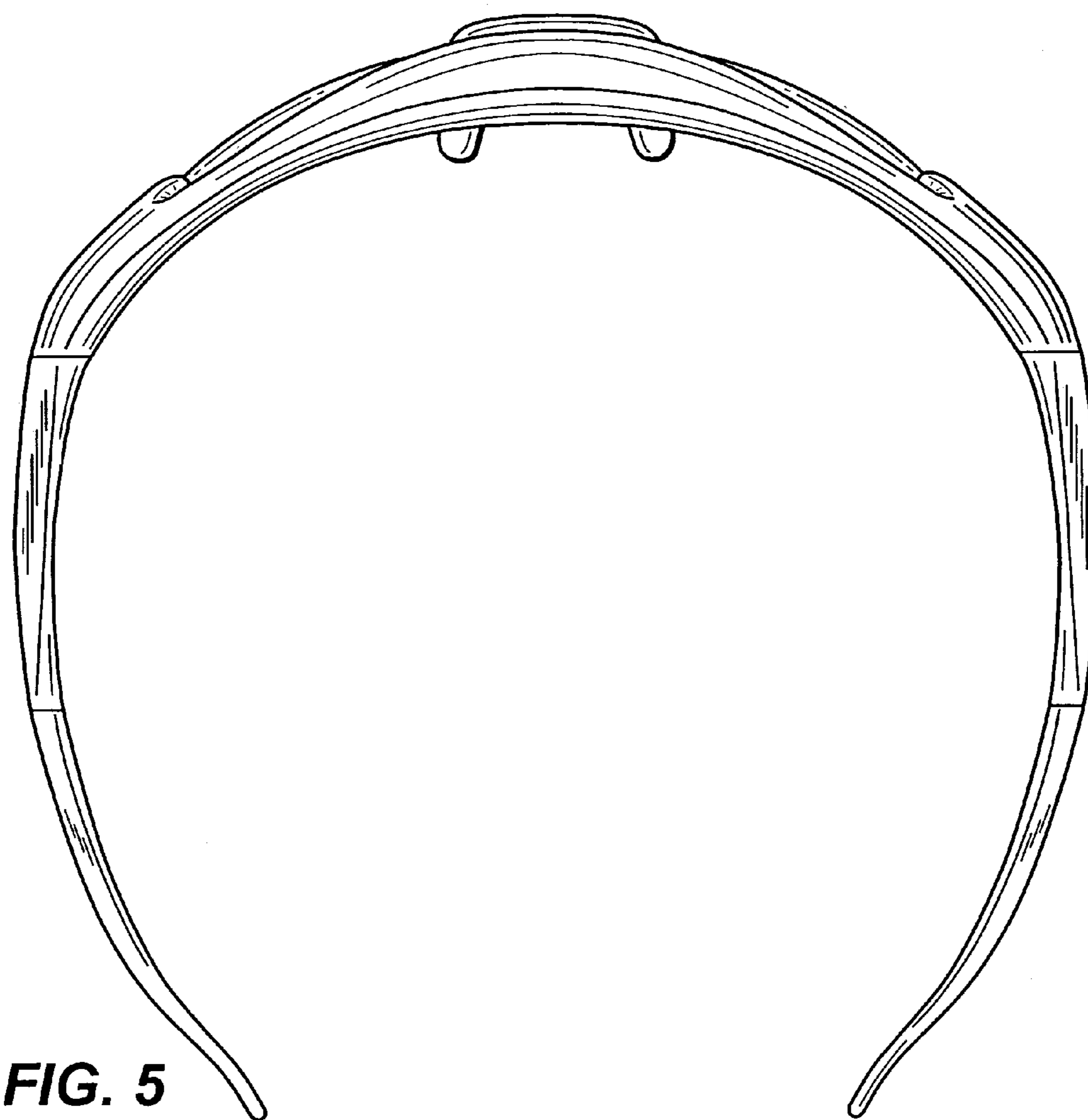

FIG. 5

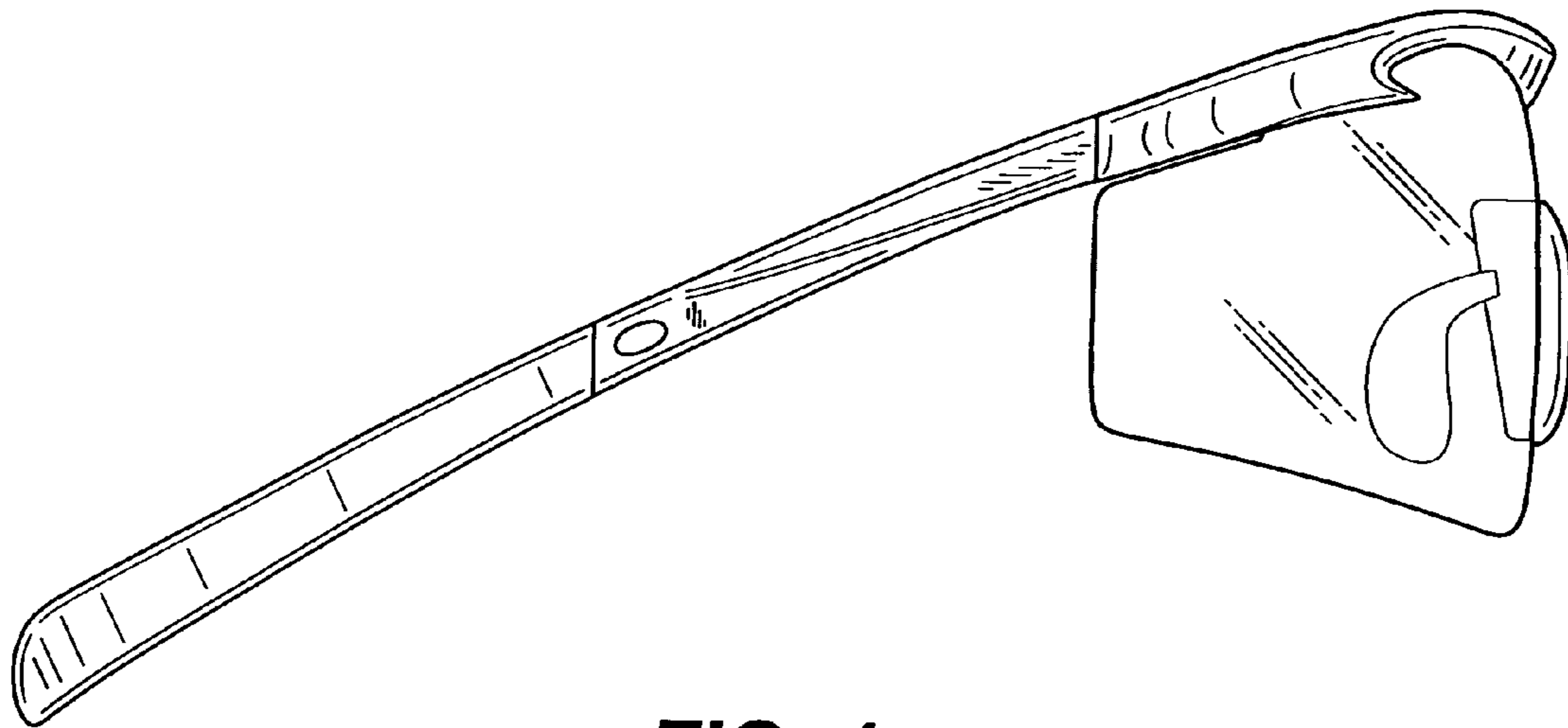

FIG. 4

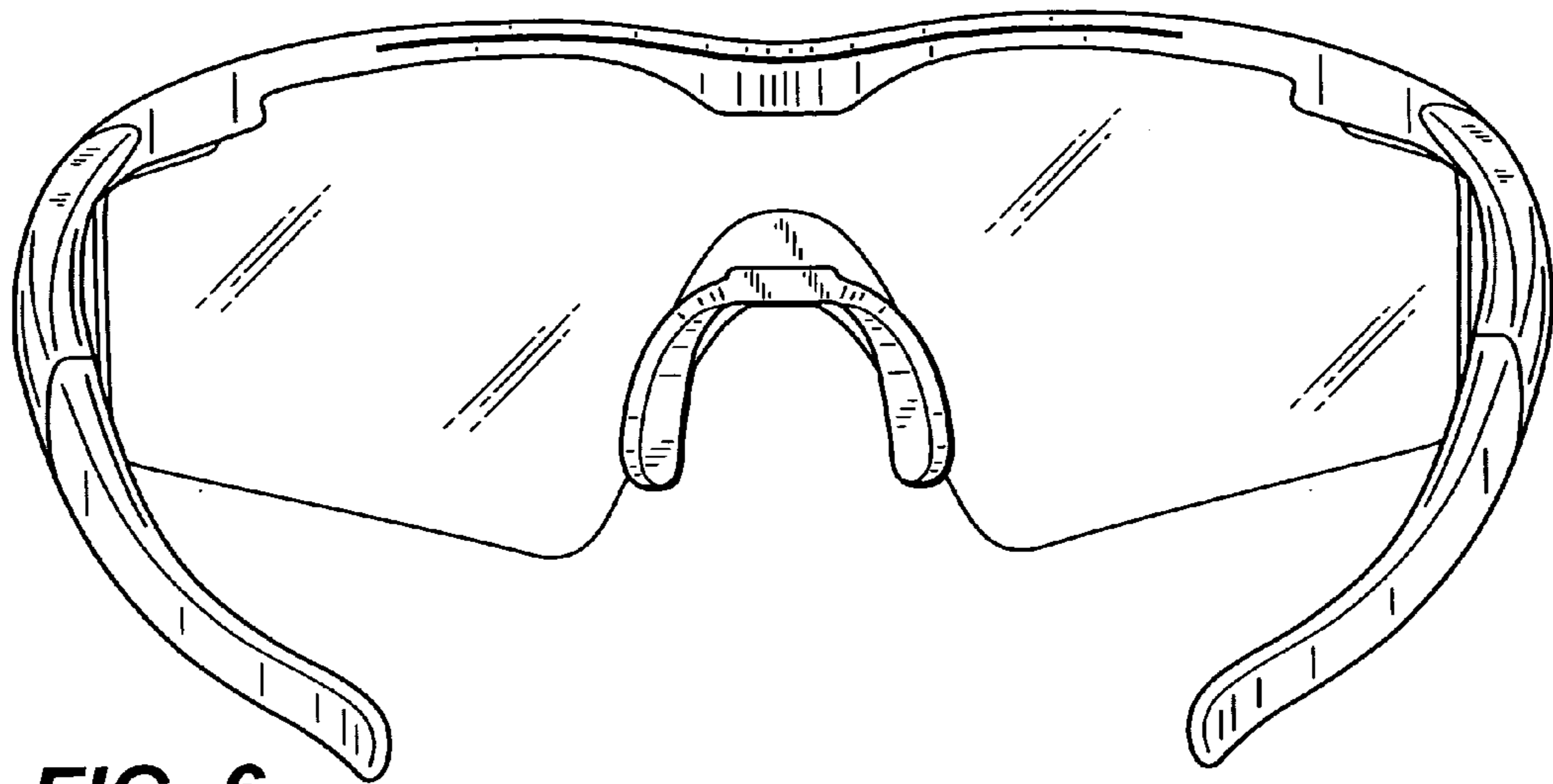

FIG. 6

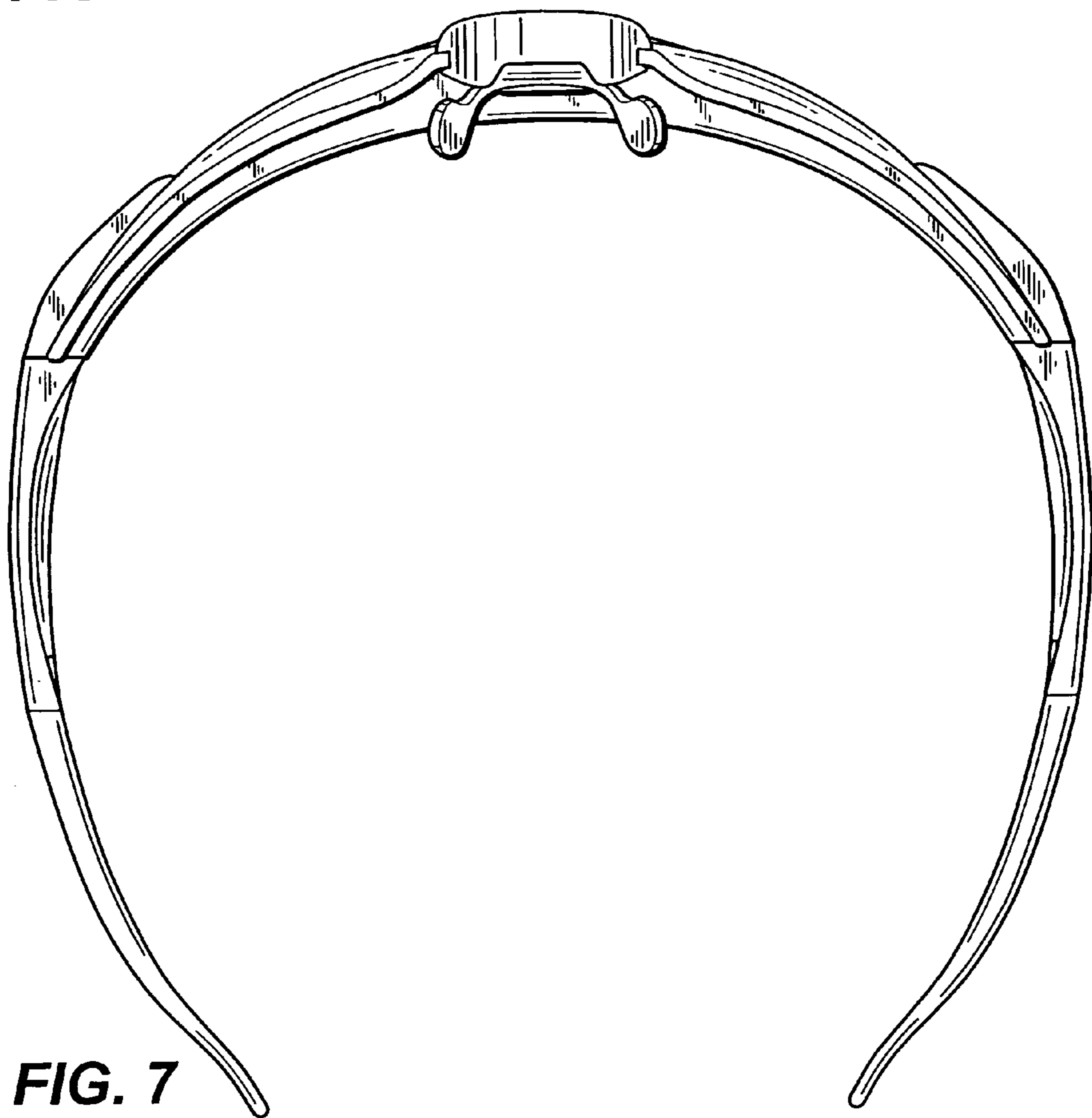

FIG. 7